

rusEFI by Art_Electro & DAECU		
File: 176-pin_board.kicad_pcb		
Sheet: 1/1		
Title: 176 pin board		
Size: A4	Date: 23 jan 2015	Rev: R0.1
KiCad E.D.A.	pcbnew (2013-07-07 BZR 4022)-stable	Id: 1/1

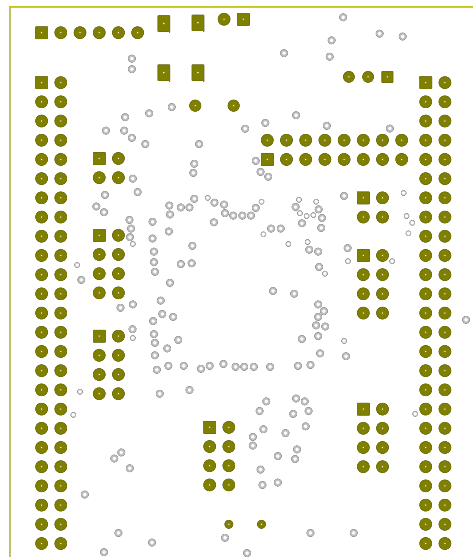

rusEFI by Art_Electro & DAECU		
File: 176-pin_board.kicad_pcb		
Sheet: 1/1		
Title: 176 pin board		
Size: A4	Date: 23 jan 2015	Rev: R0.1
KiCad E.D.A.	pcbnew (2013-07-07 BZR 4022)-stable	Id: 1/1

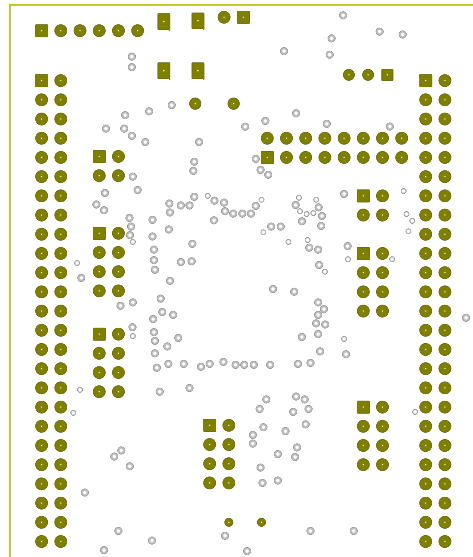

rusEFI by Art_Electro & DAECU		
File: 176-pin_board.kicad_pcb		
Sheet: 1/1		
Title: 176 pin board		
Size: A4	Date: 23 jan 2015	Rev: R0.1
KiCad E.D.A.	pcbnew (2013-07-07 BZR 4022)-stable	Id: 1/1

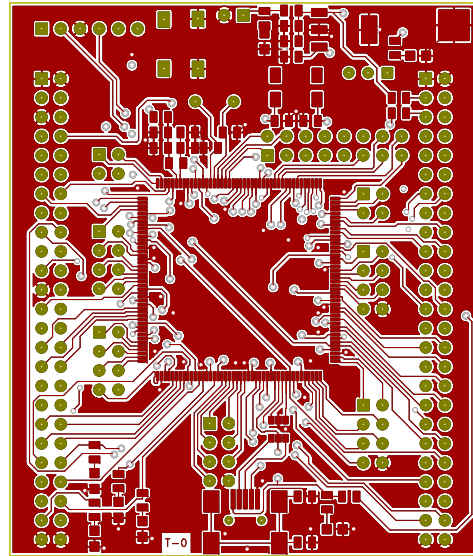

rusEFI by Art_Electro & DAECU		
File: 176-pin_board.kicad_pcb		
Sheet: 1/1		
Title: 176 pin board		
Size: A4	Date: 23 jan 2015	Rev: R0.1
KiCad E.D.A.	pcbnew (2013-07-07 BZR 4022)-stable	Id: 1/1

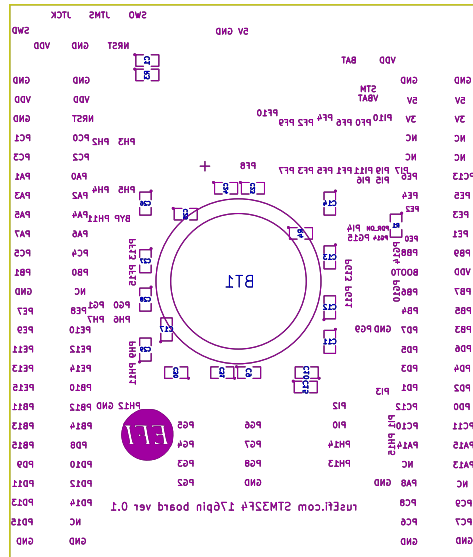

rusEFL by Art_Electro & DAECU		
File: 176-pin_board.kicad_pcb		
Sheet: 1/1		
Title: 176 pin board		
Size: A4	Date: 23 jan 2015	Rev: R0.1
KiCad E.D.A.	pcbnew (2013-07-07 BZR 4022)-stable	Id: 1/1

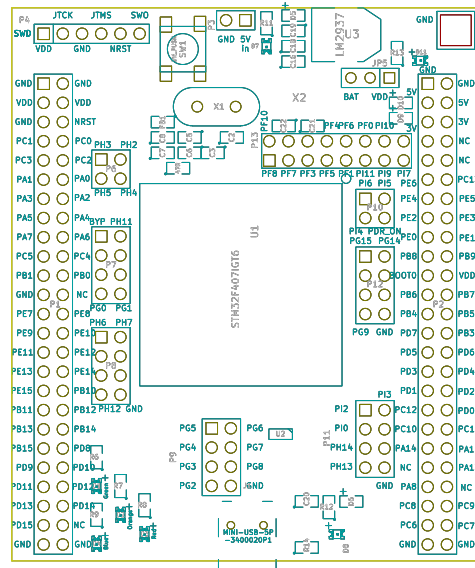

rusEFI by Art_Electro & DAECU		
File: 176-pin_board.kicad_pcb		
Sheet: 1/1		
Title: 176 pin board		
Size: A4	Date: 23 jan 2015	Rev: R0.1
KiCad E.D.A. pcbnew (2013-07-07 BZR 4022)-stable		Id: 1/1

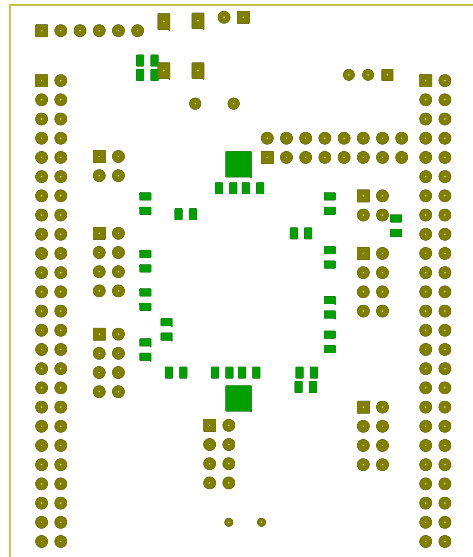

rusEFI by Art_Electro & DAECU		
File: 176-pin_board.kicad_pcb		
Sheet: 1/1		
Title: 176 pin board		
Size: A4	Date: 23 jan 2015	Rev: R0.1
KiCad E.D.A.	pcbnew (2013-07-07 BZR 4022)-stable	Id: 1/1

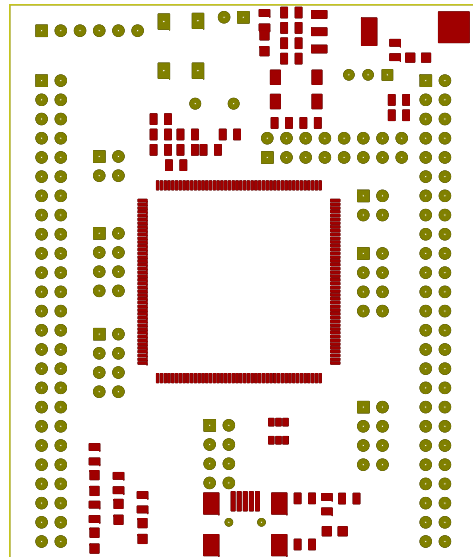

rusEFI by Art_Electro & DAECU		
File: 176-pin_board.kicad_pcb		
Sheet: 1/1		
Title: 176 pin board		
Size: A4	Date: 23 jan 2015	Rev: R0.1
KiCad E.D.A.	pcbnew (2013-07-07 BZR 4022)-stable	Id: 1/1

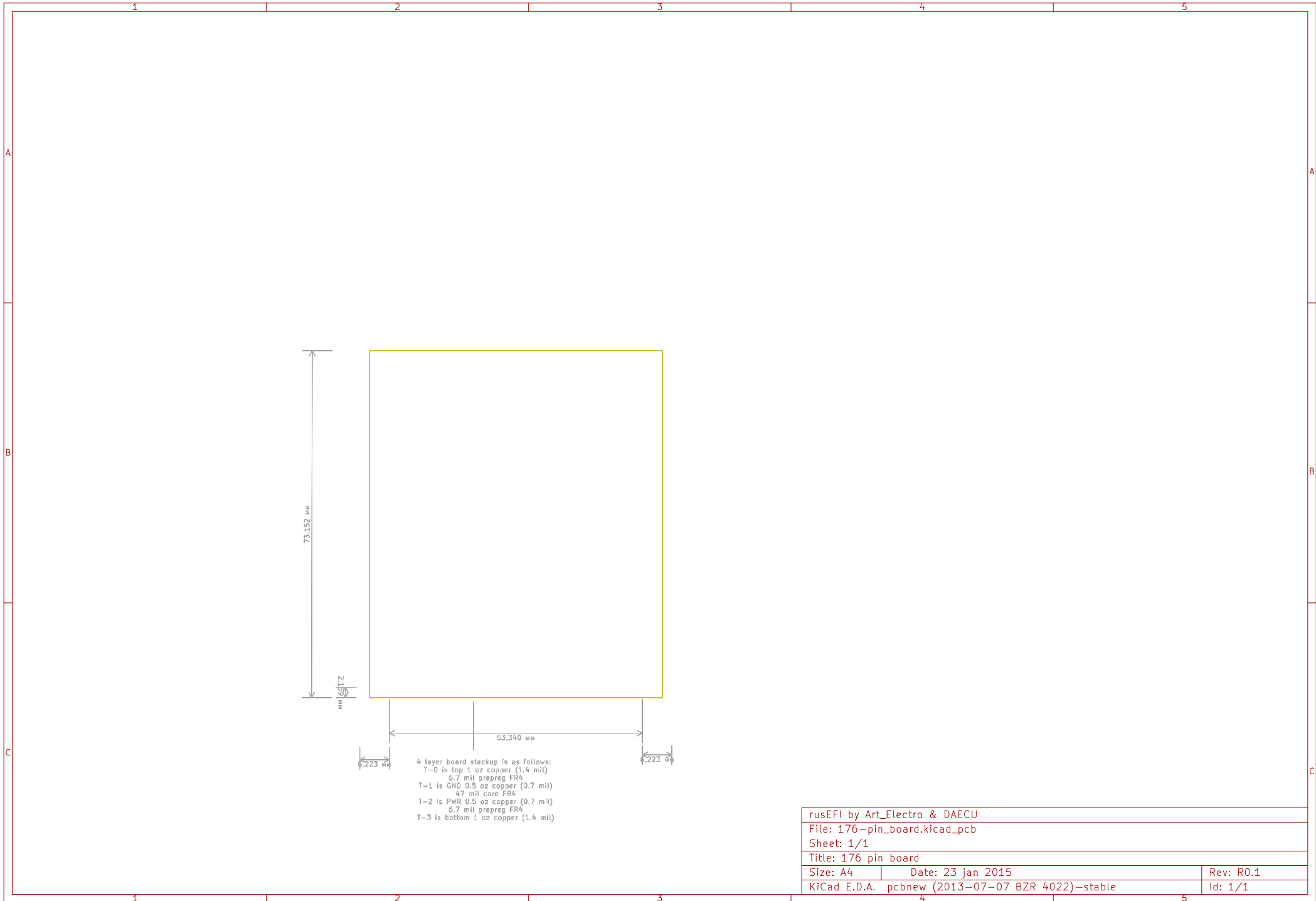

rusEFI by Art_Electro & DAECU		
File: 176-pin_board.kicad_pcb		
Sheet: 1/1		
Title: 176 pin board		
Size: A4	Date: 23 jan 2015	Rev: R0.1
KiCad E.D.A.	pcbnew (2013-07-07 BZR 4022)-stable	Id: 1/1