

ENGINE CONTROLS

Engine Controls

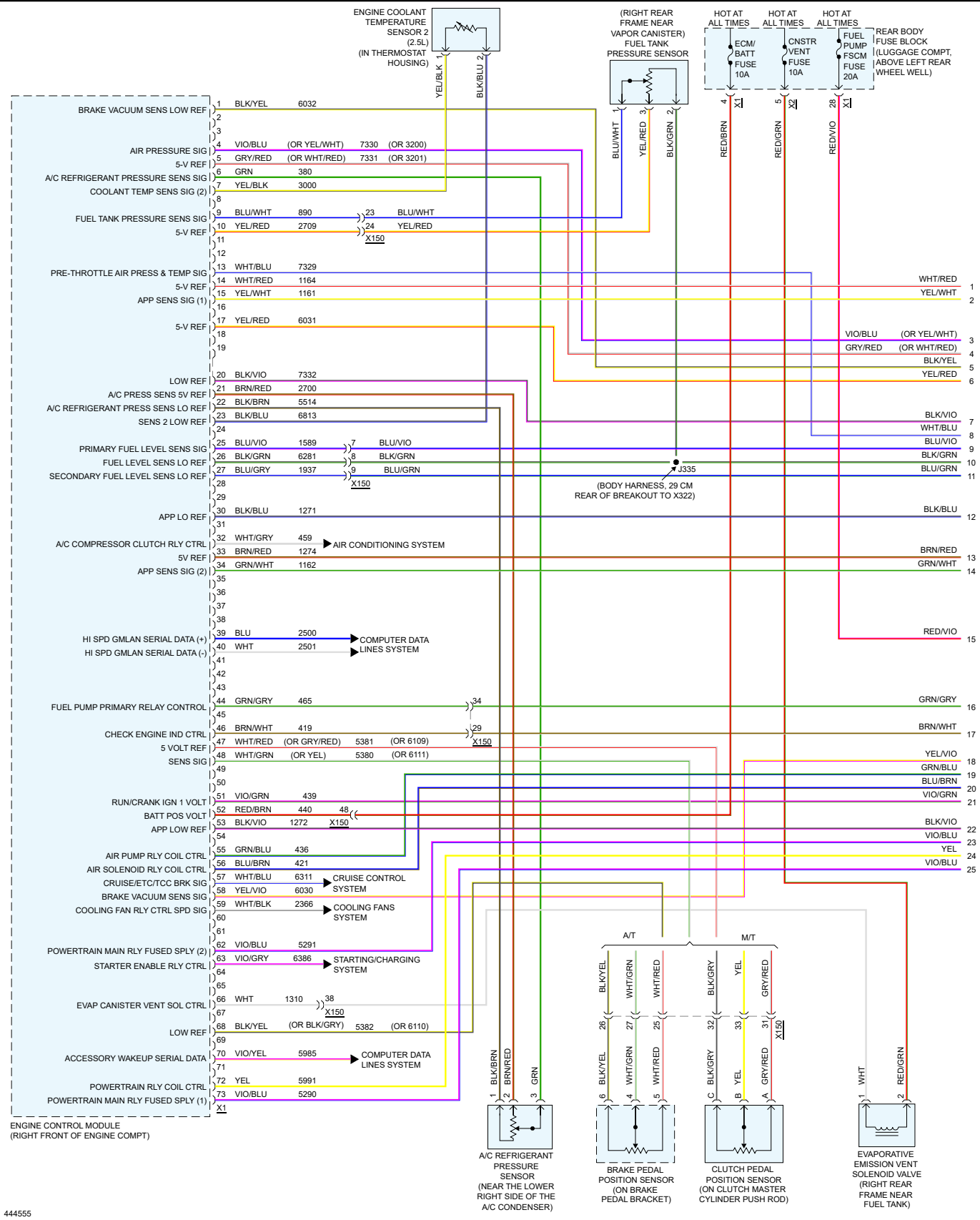

444555

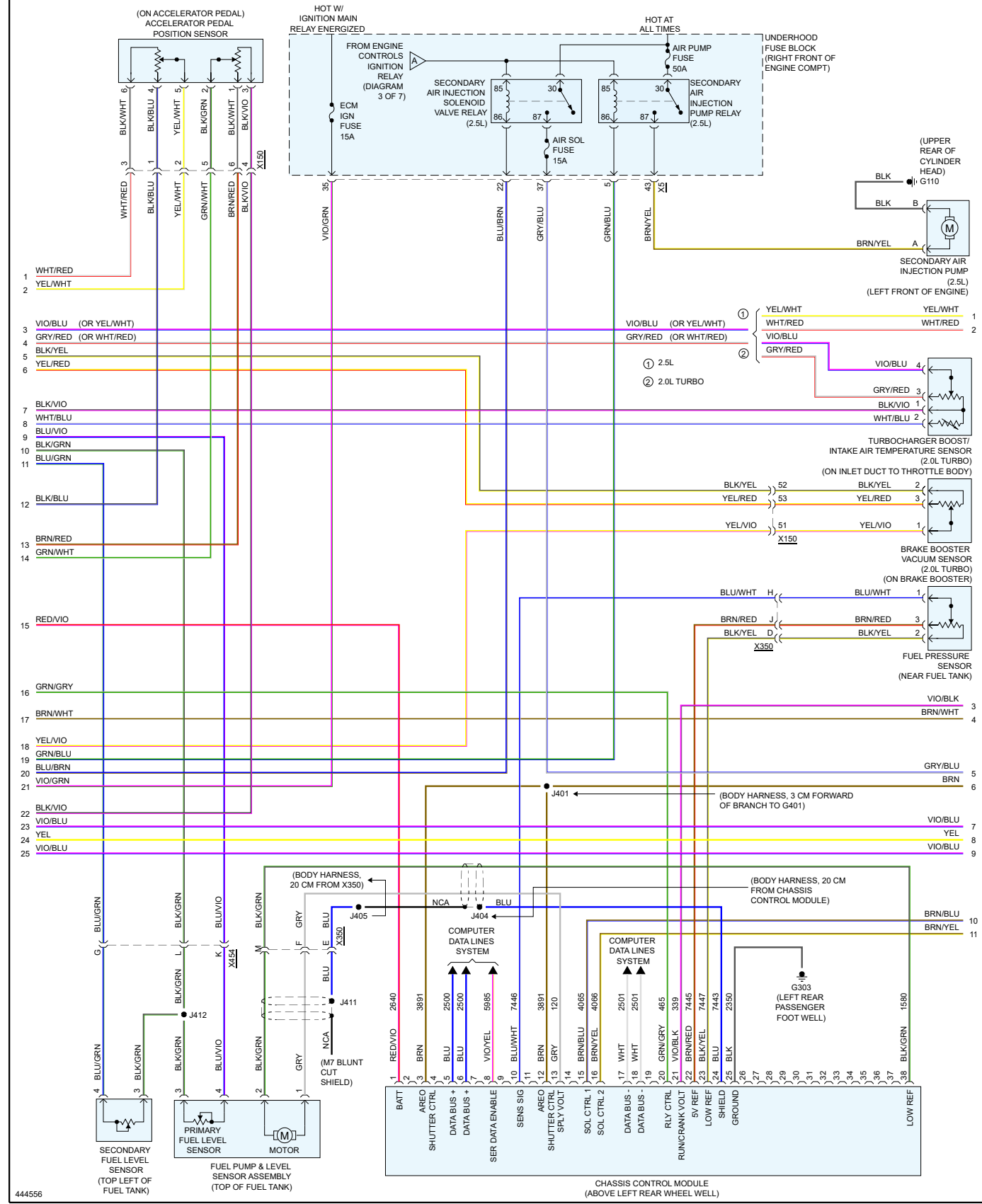

444556

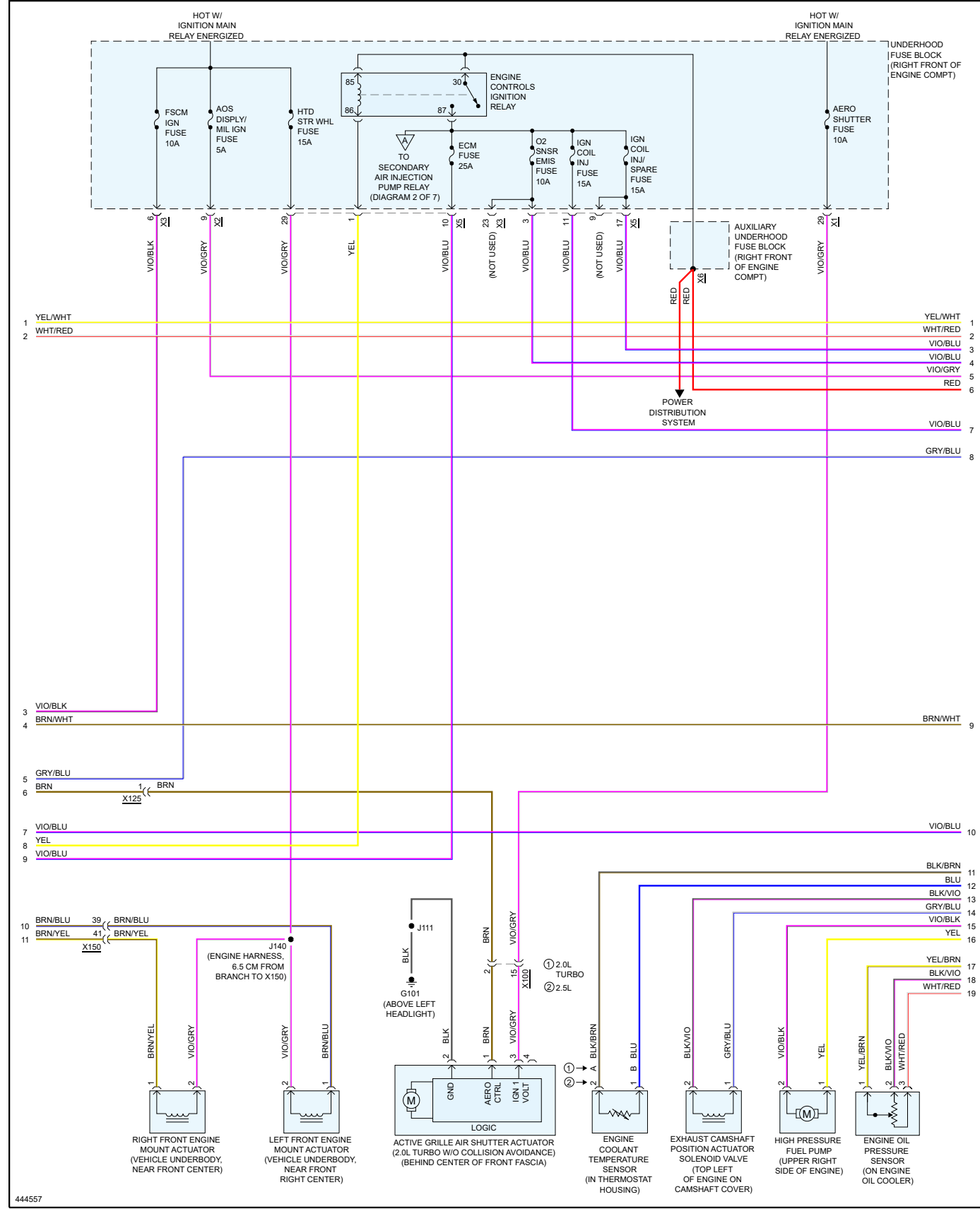

444557

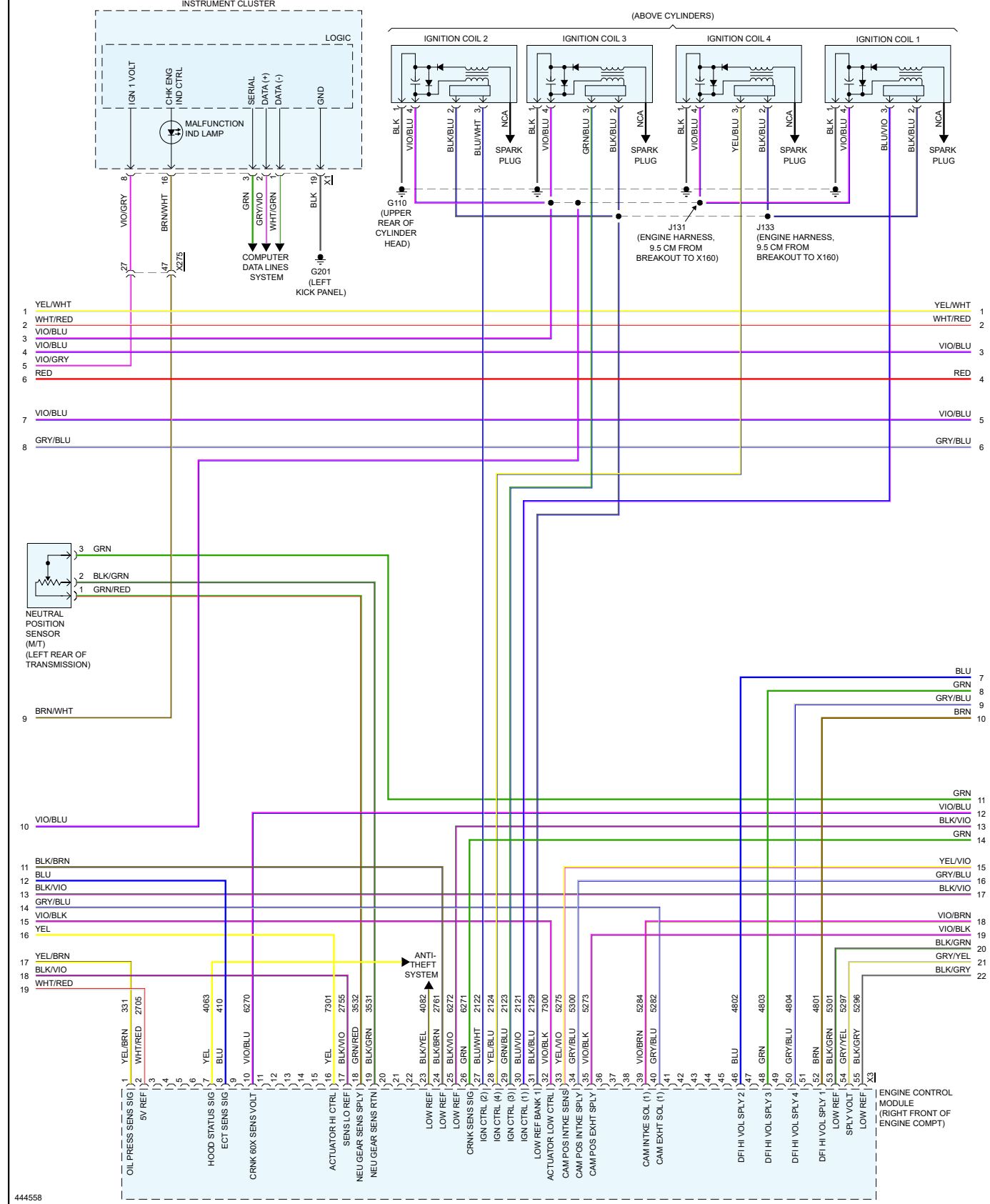

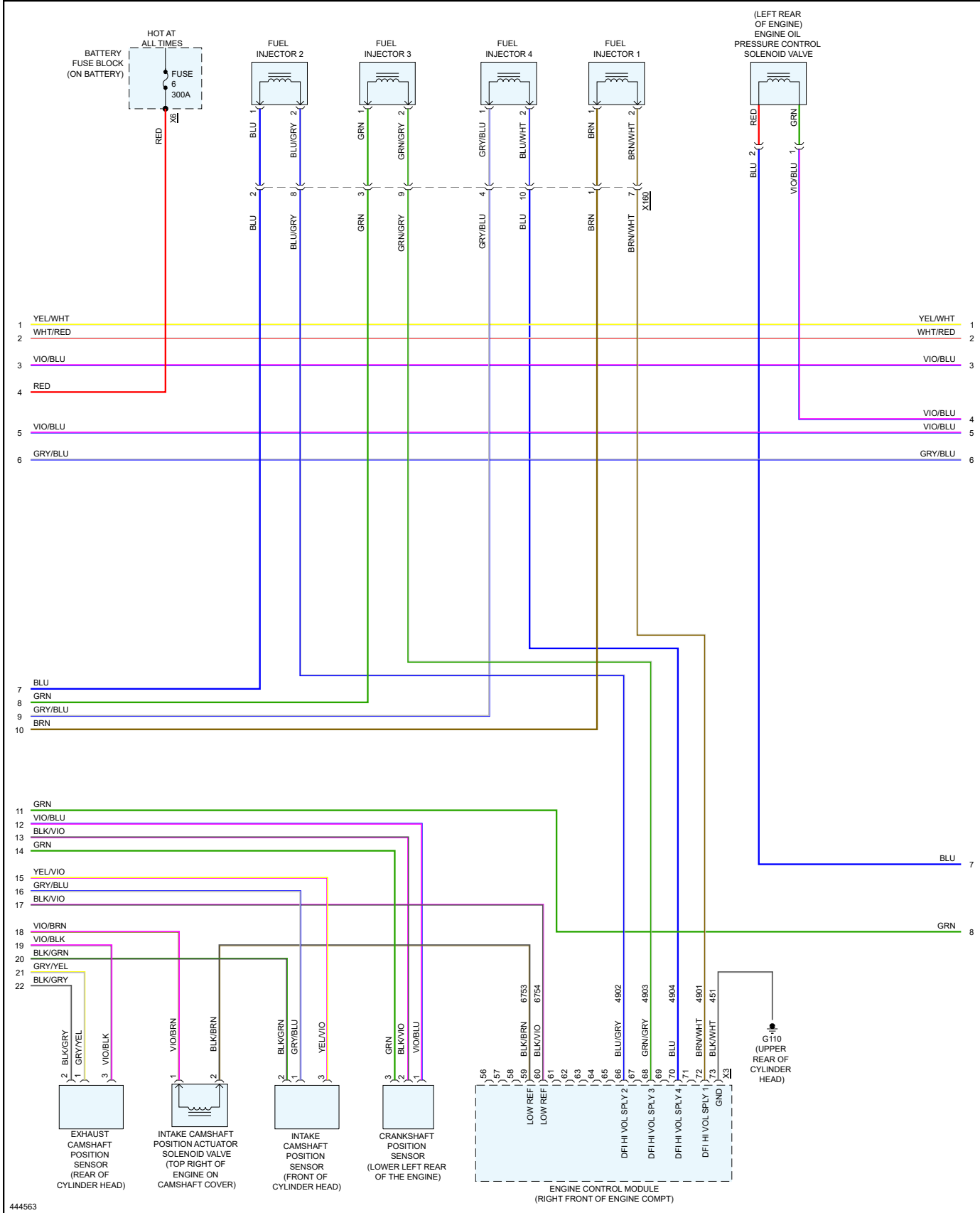

444563

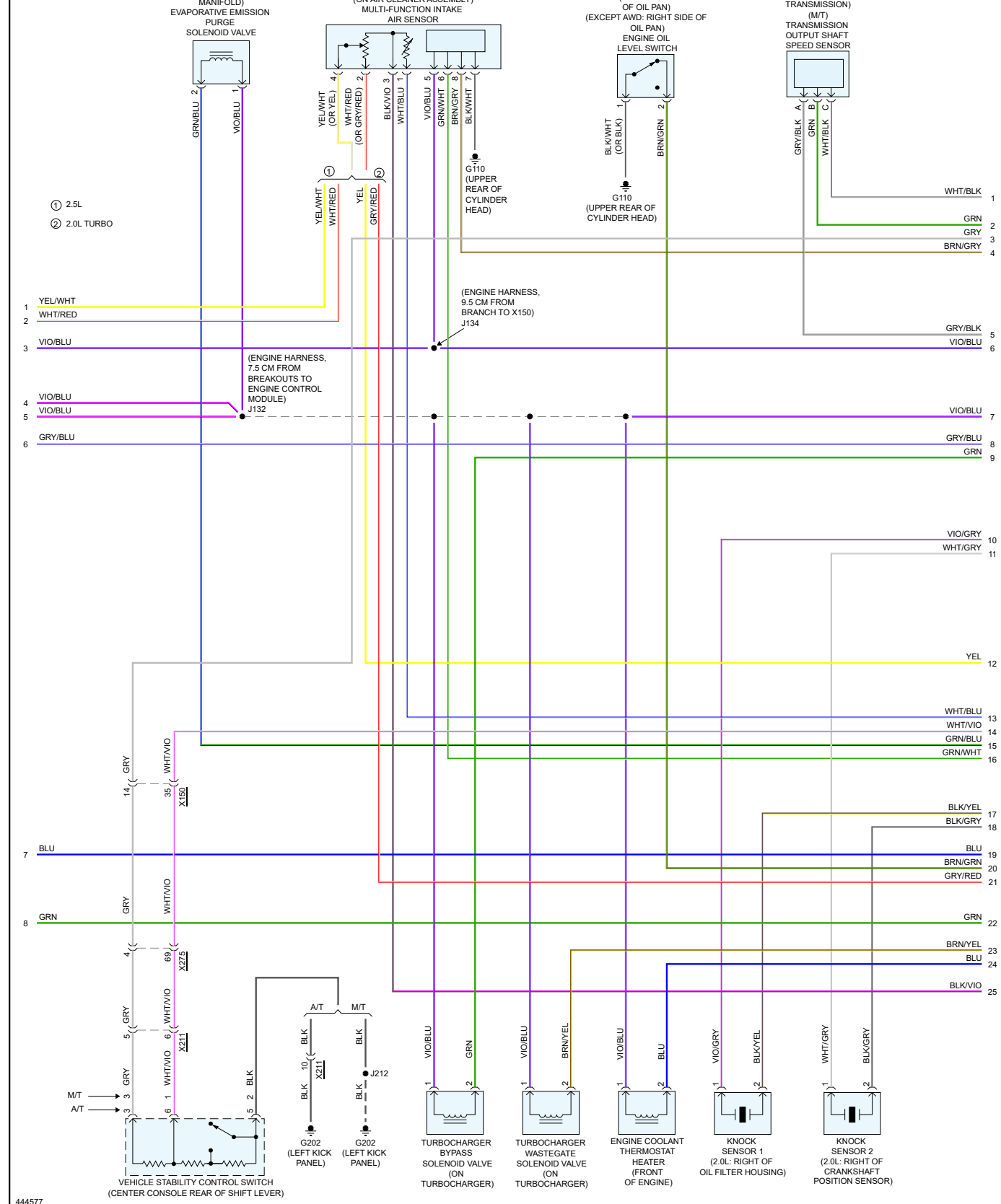

444577

(AFTER CATALYTIC CONVERTER) HEATED OXYGEN SENSOR 2

(2.0L: IN EXHAUST MANIFOLD) HEATED OXYGEN SENSOR 1

SECONDARY AIR INJECTION SOLENOID VALVE (2.5L) (REAR OF EXHAUST MANIFOLD)

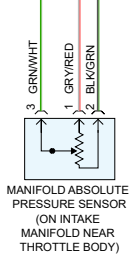
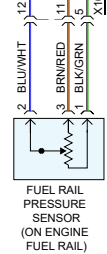
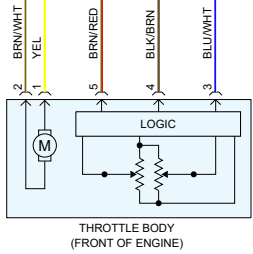
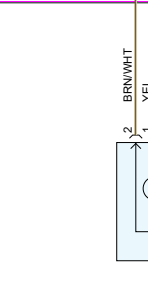
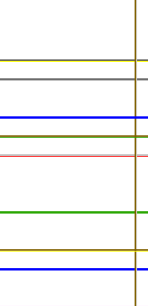
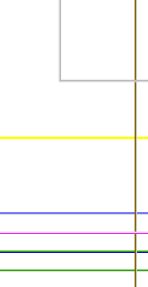
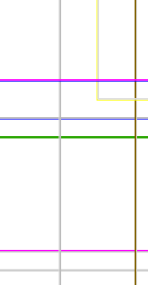
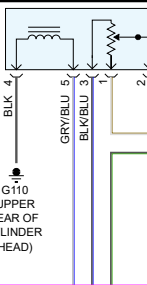
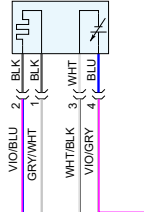
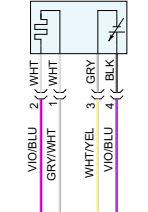

6331	WHT/BRN	1	SENS SIG
6452	WHT/BRN	2	SPLY VOLT
2919	BLK/GRN	3	LOW REF
		4	
3097	WHT/BLK	5	5V REF
		6	
		7	
3098	GRN	8	OUT SPD SIG
		9	
3110	VIO/GRY	10	BANK 1 SNSR (1)
		11	
3120	VIO/BLU	12	BANK 1 SNSR (2)
		13	
4109	GRY	14	5V REF
4008	BRN/GRY	15	SENS SIG
582	BRN/WHT	16	TAC CLOSE
6785	BLK/BLU	17	LOW REF
2917	BRN/RED	18	5V REF
2918	BLU/WHT	19	FUEL RAIL PRESS SENS SIG
		20	
3096	GRY/BLK	21	OUT SPD 5V RTN
		22	
		23	
		24	
		25	
3111	WHT/BLK	26	BANK 1 SENS (1)
		27	
3121	WHT/YEL	28	BANK 1 SENS (2)
		29	
3060	GRN	30	CTRL BANK (1)
		31	
581	YEL	32	TAC OPEN
		33	
2701	BRN/RED	34	5V REF
		35	
496	VIO/GRY	36	KNOCK SENS SIG (1)
1876	WHT/GRY	37	KNOCK SENS SIG (2)
		38	
121	WHT	39	ENG SPD SIG
6091	VIO/BLU	40	CRNK POS SENS SIG
3113	GRY/WHT	41	BANK 1 SENS (1)
3122	GRY/WHT	42	BANK 1 SENS (2)
432	GRN/WHT	43	MAP SENS SIG
2704	GRY/RED	44	5V REF
3054	YEL	45	SENS SIG BANK (1)
		46	
		47	
		48	
6289	WHT/BLU	49	AIR TEMP SENS SIG
4108	WHT/VIO	50	DRV MOD SW SIG
428	GRN/BLU	51	PURGE SOL CTRL
492	GRN/WHT	52	MAF SENS SIG
		53	STARTING/CHARGING SYSTEM
25	BRN	53	CHARGE IND CTRL
2752	BLK/BRN	54	LOW REF
		54	STARTING/CHARGING SYSTEM
23	GRY	55	GENERATOR FIELD
1716	BLK/YEL	56	KNOCK SENS (1)
2303	BLK/GRY	57	KNOCK SENS (2)
1786	WHT/GRY	58	TRANS PRK/NEU SIG
179	BLU	59	OIL PMP SIG
1174	BRN/GRN	60	OIL LEVEL SW SIG
		61	
		62	
469	BLK/GRN	63	MAP LOW REF
3053	GRY/RED	64	HI REF BANK 1
		65	
		66	
3534	GRN	67	NEU GEAR SENS SIG
		68	
2760	BLK/VIO	69	IAT SENS LOW REF
3630	BLU/WHT	70	TAC SENS SIG
258	BRN/YEL	71	WAST GAT SOL CTRL
6814	BLU	72	ENG COOL CTRL
451	BLK/WHT (OR BLK)	73	ENG COOL CTRL
		X2	GND

INSTRUMENT CLUSTER SYSTEM
SOUND SYSTEMS

STARTING/CHARGING SYSTEM

STARTING/CHARGING SYSTEM

TRANSMISSIONS SYSTEM

ENGINE CONTROL MODULE (RIGHT FRONT OF ENGINE COMPT)