

## ENGINE CONTROLS

### Engine Controls

---

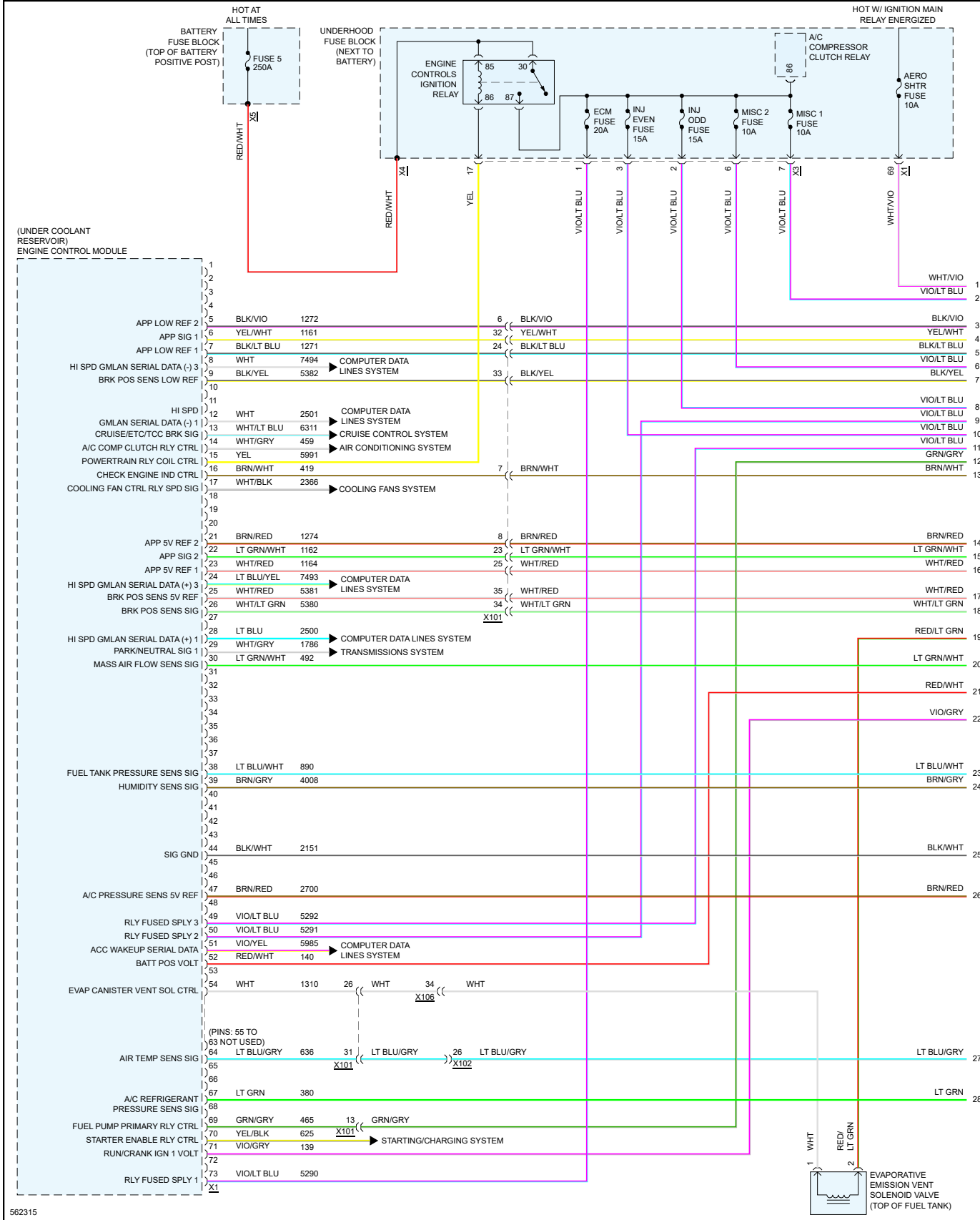

(BEHIND UPPER GRILLE)  
ACTIVE GRILLE AIR  
SHUTTER ACTUATOR

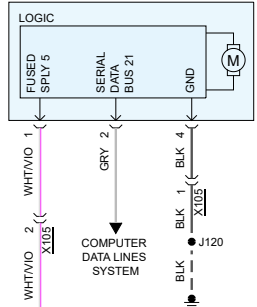

(ACCELERATOR  
PEDAL BRACKET)  
ACCELERATOR PEDAL  
POSITION SENSOR



(ABOVE BRAKE  
PEDAL ASSEMBLY)  
BRAKE PEDAL  
POSITION SENSOR

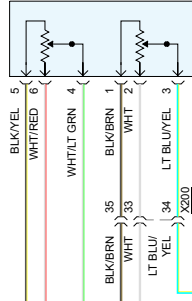

(LEFT SIDE OF DASH)  
BODY CONTROL MODULE

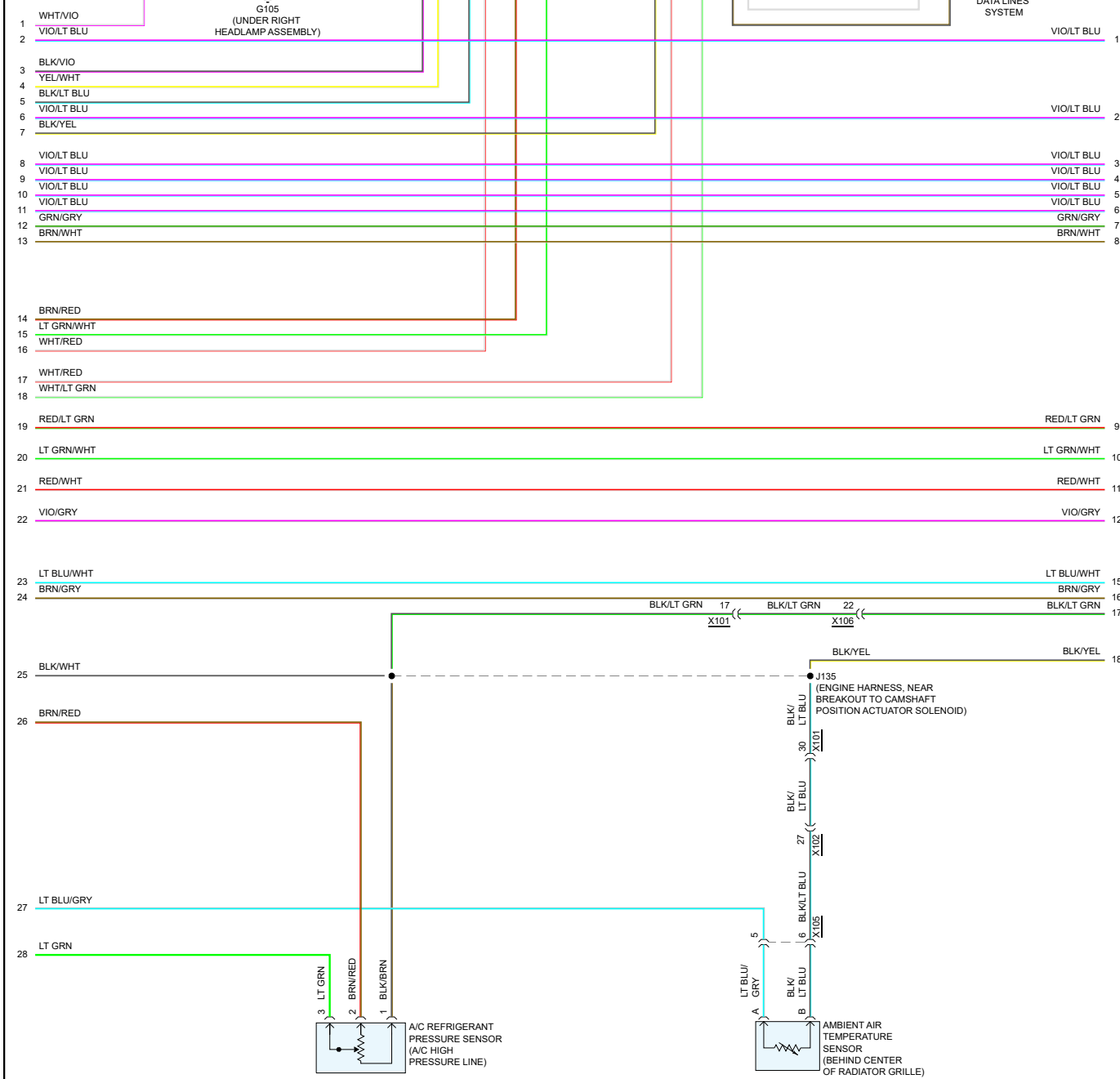
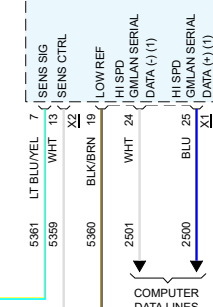

562316

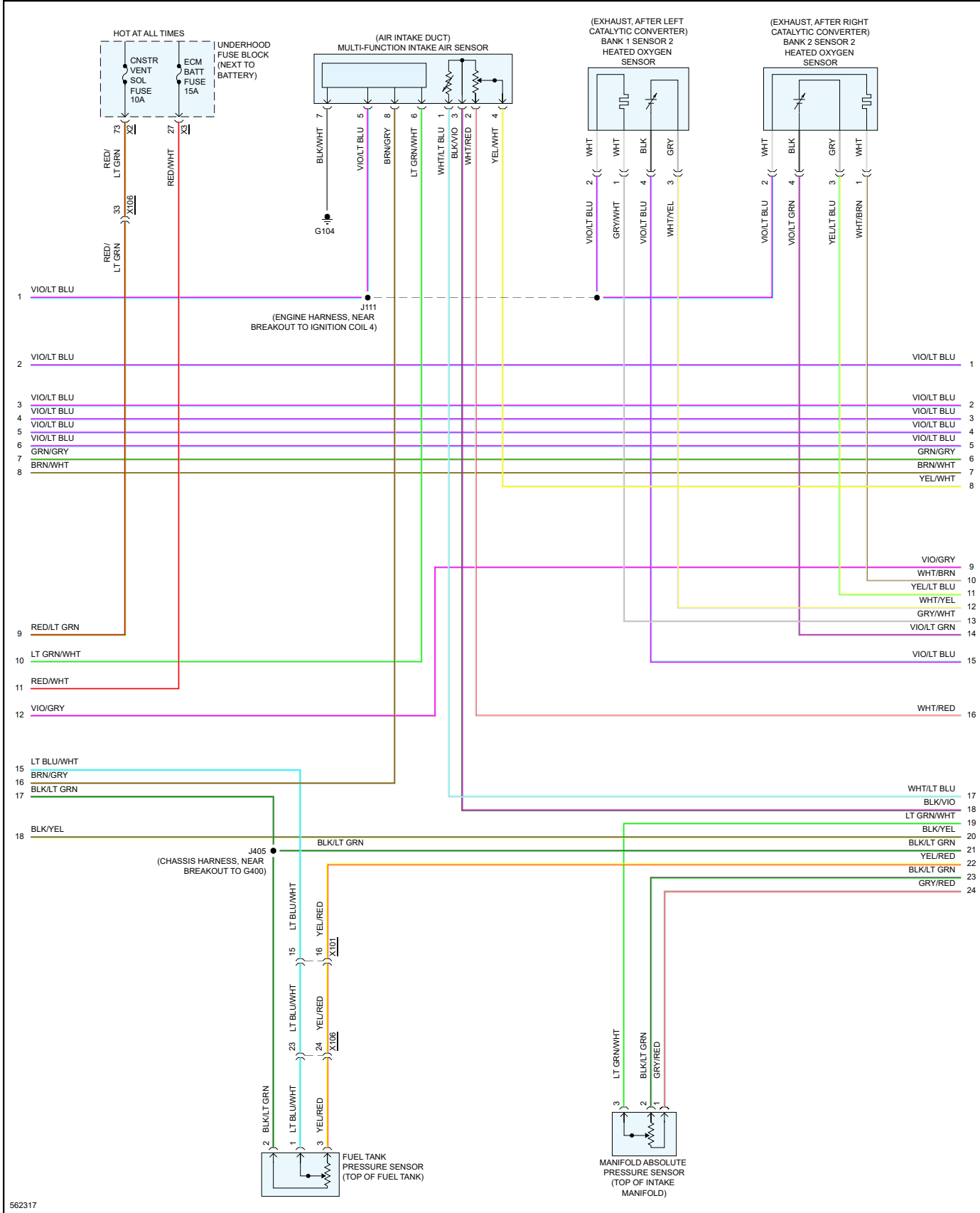

562317

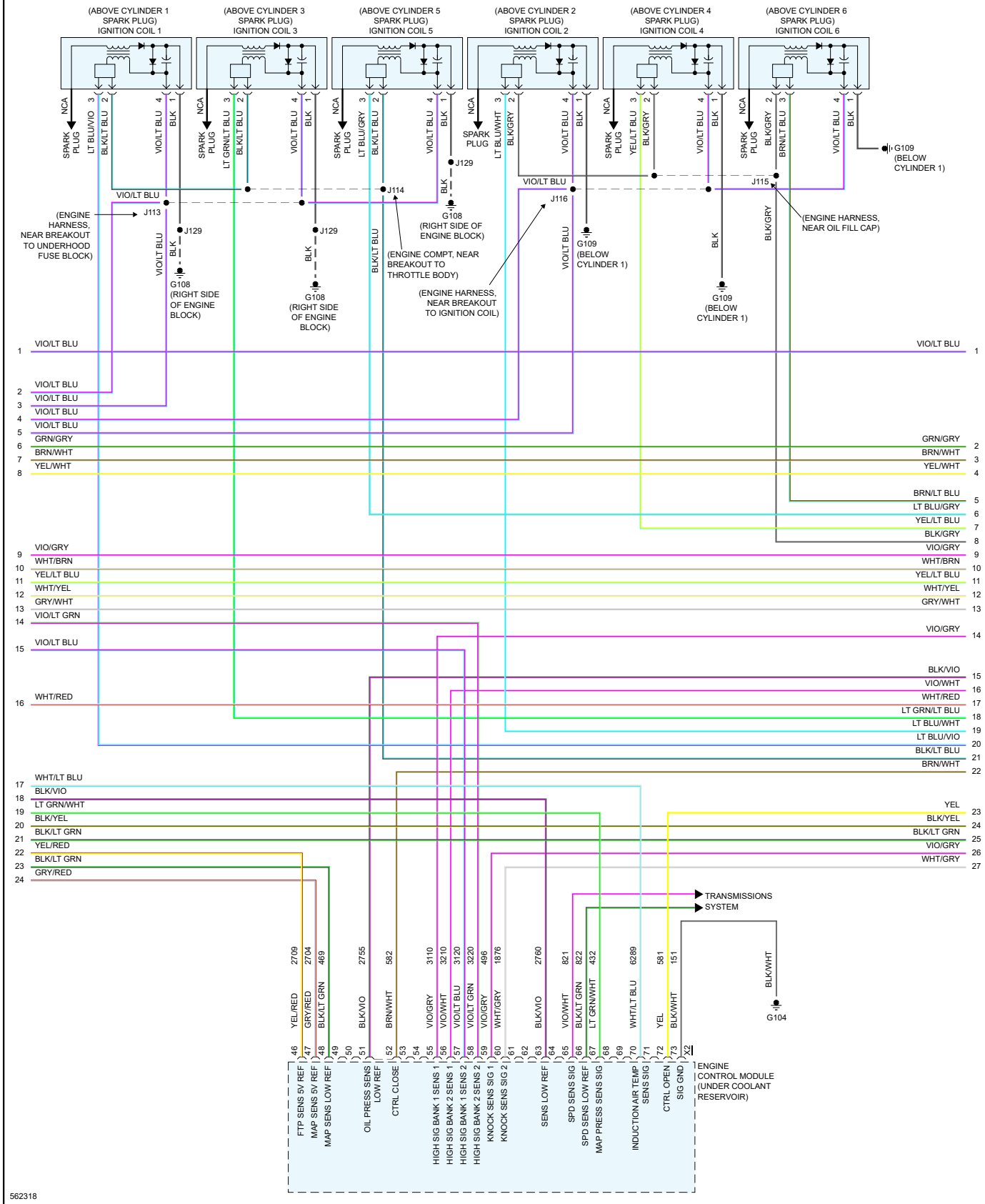

562318

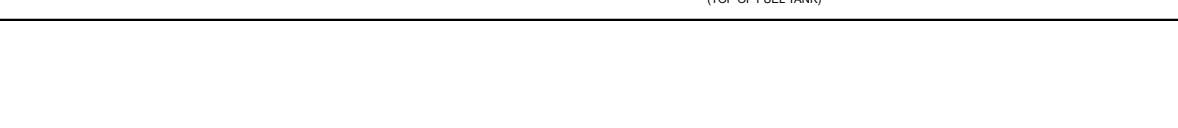
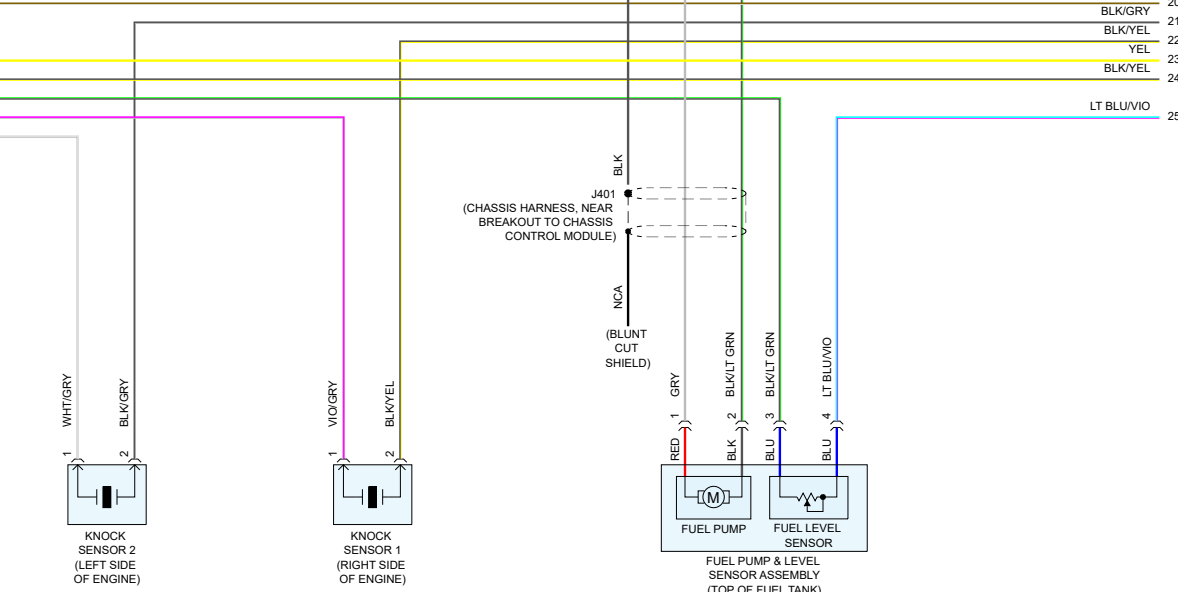
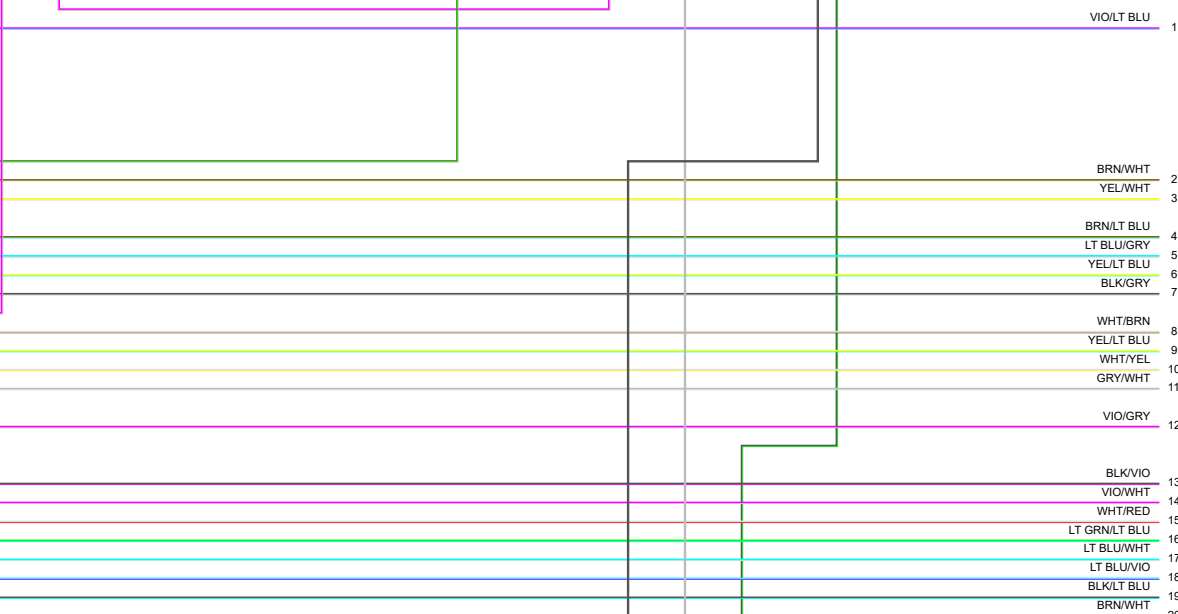
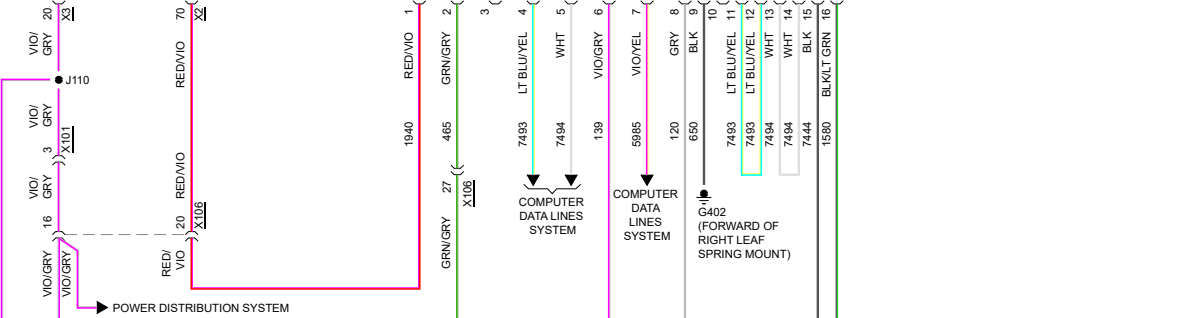
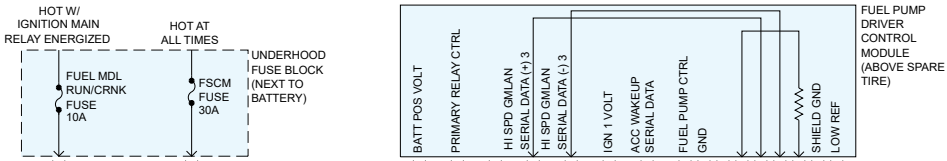

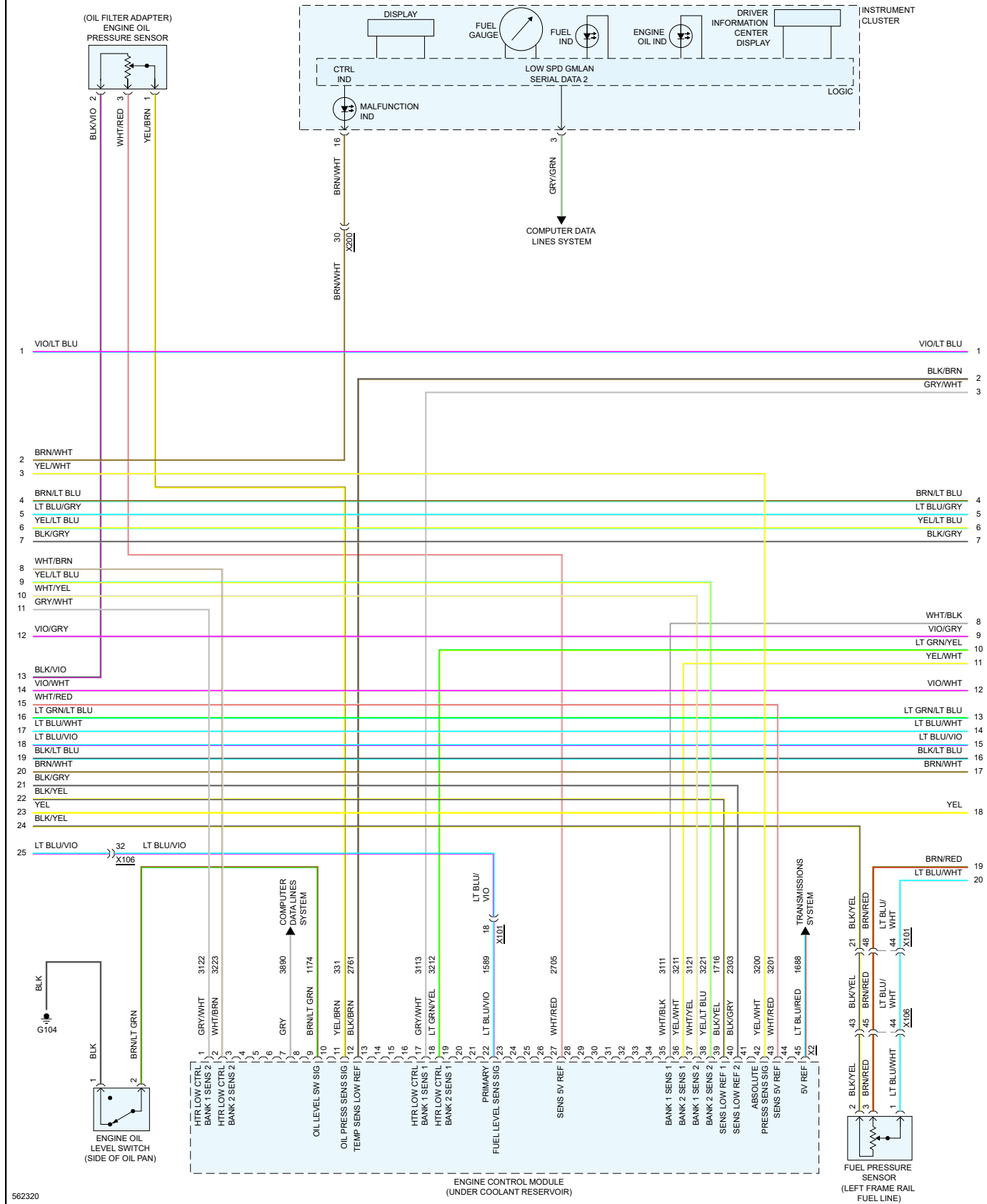

562320

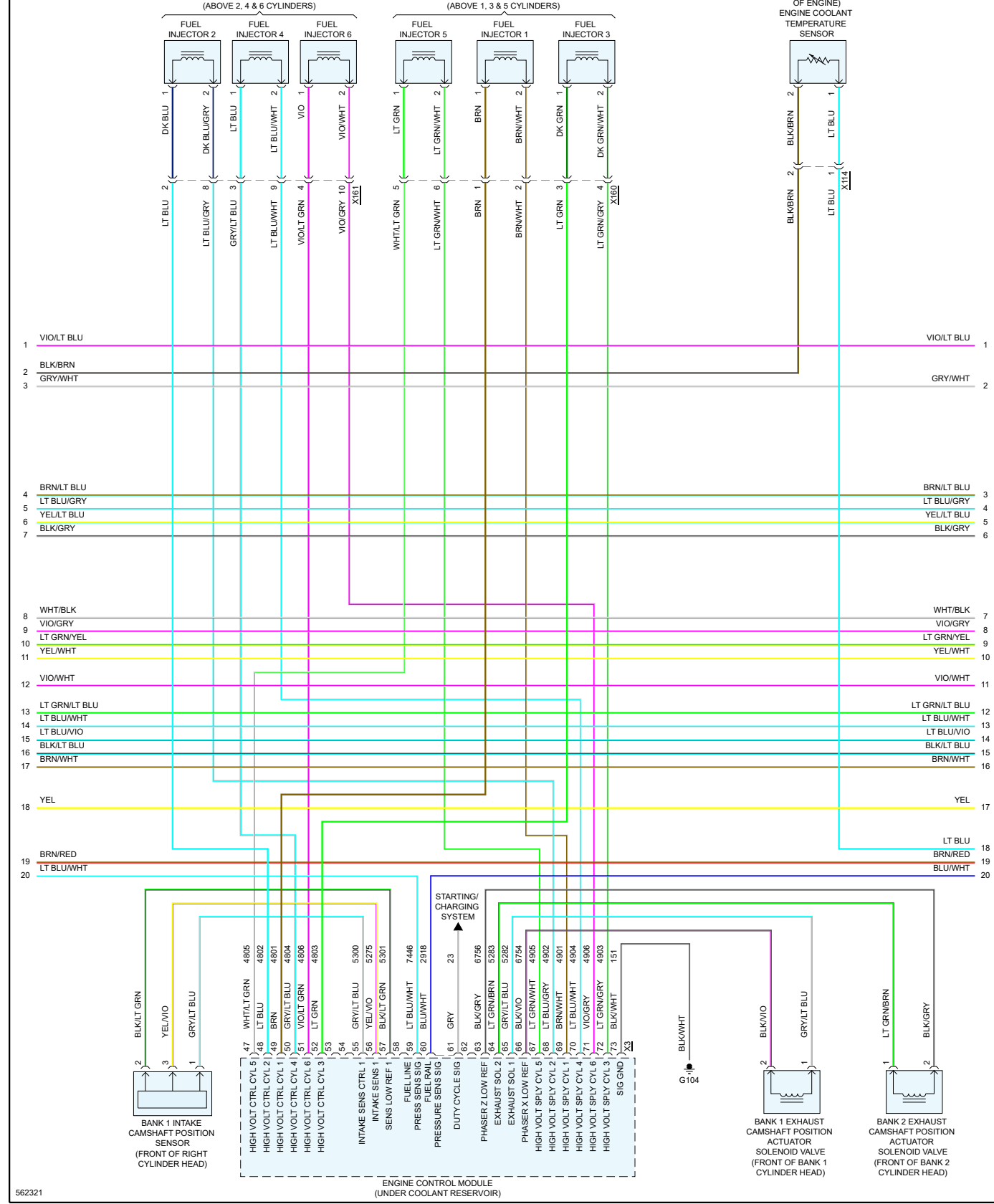



(EXHAUST, BEFORE LEFT CATALYTIC CONVERTER)  
BANK 1 SENSOR 1  
HEATED OXYGEN SENSOR

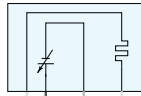

WHT  
BLK  
GRY  
WHT  
VIO/LT BLU

GRY/WHT 1  
VIO/GRY 4  
WHT/BLK 3  
VIO/LT BLU 2

(EXHAUST, BEFORE RIGHT CATALYTIC CONVERTER)  
BANK 2 SENSOR 1  
HEATED OXYGEN SENSOR

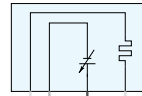

WHT  
GRY  
BLK  
WHT  
VIO/LT BLU

LT GRN/YEL 1  
YEL/WHT 3  
VIO/WHT 4  
VIO/LT BLU 2

(REAR OF ENGINE BLOCK)  
CRANKSHAFT  
POSITION SENSOR

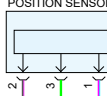

BLK/VIO 2  
LT GRN 3  
VIO/LT BLU 1

BANK 1 VALVE  
LIFTER OIL  
SOLENOID VALVE

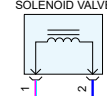

VIO/LT BLU 1  
BLU 2

(ENGINE HARNESS, NEAR BREAKOUT TO UNDERHOOD FUSE BLOCK)  
J107

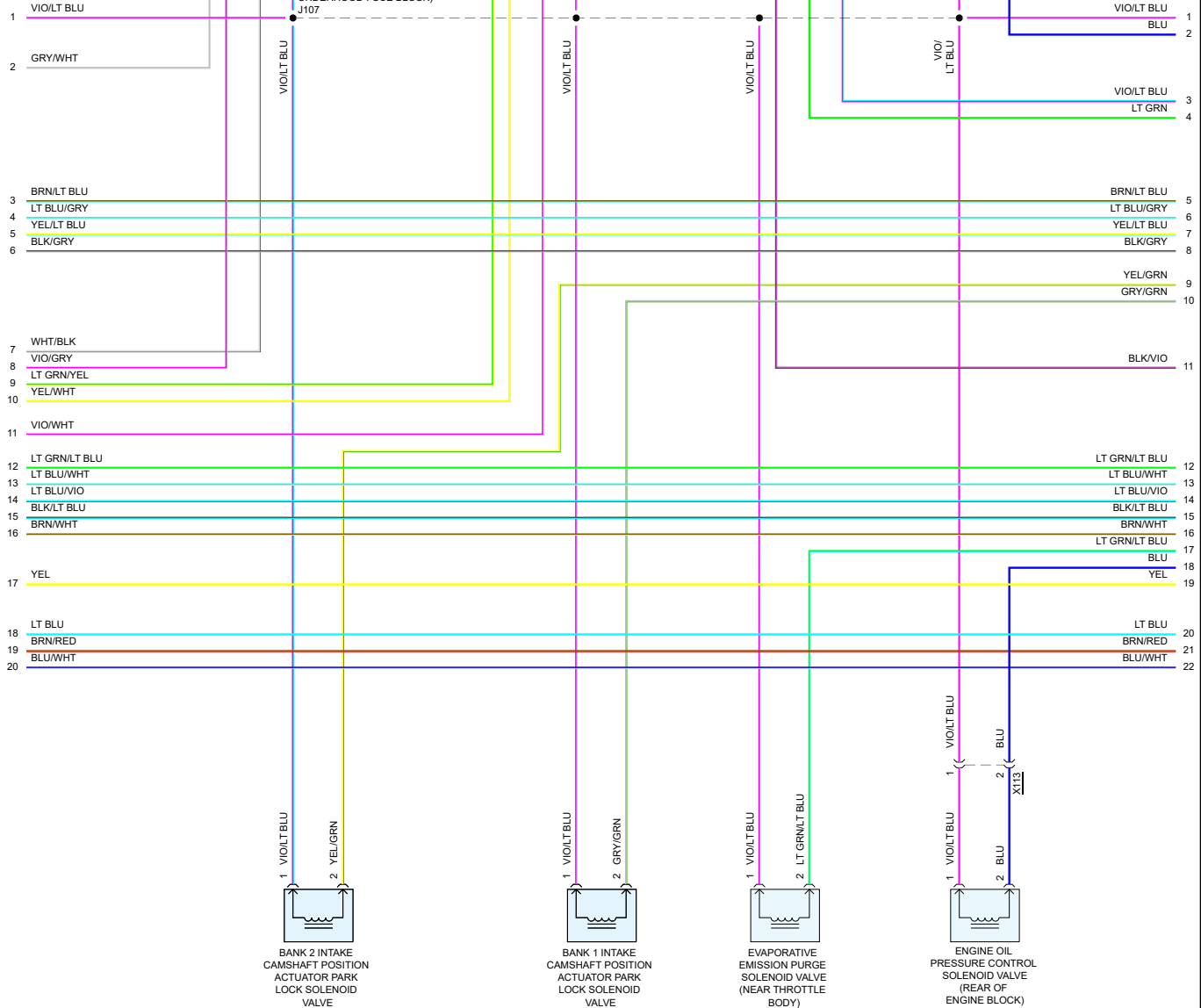

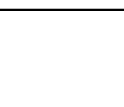
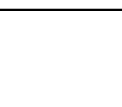
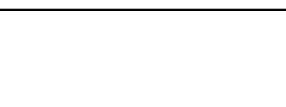
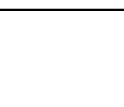
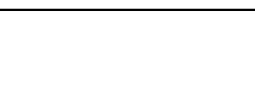
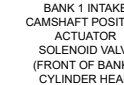
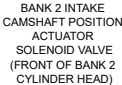
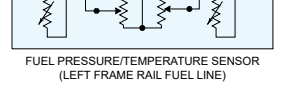
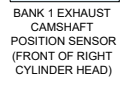
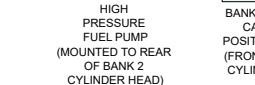
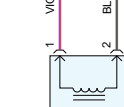
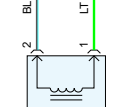
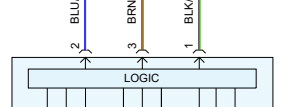
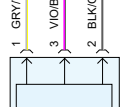
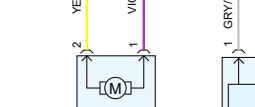
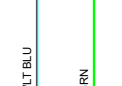
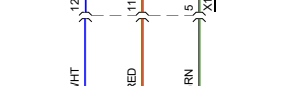
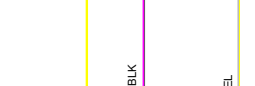
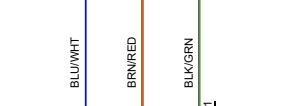
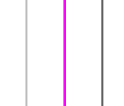
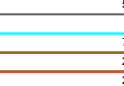
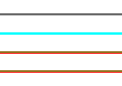
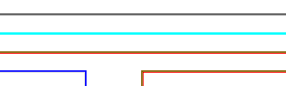
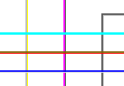
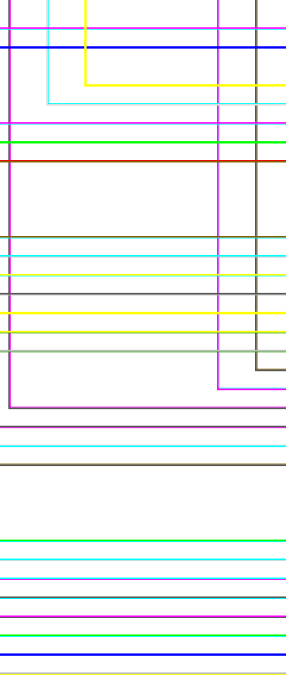
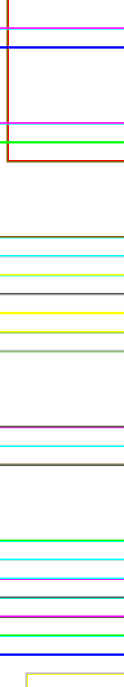
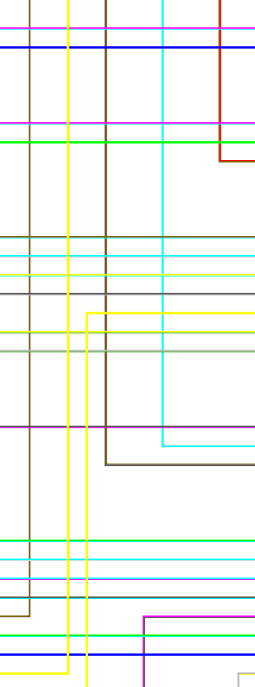
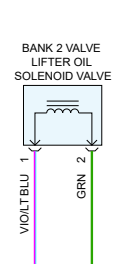
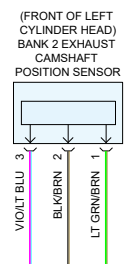
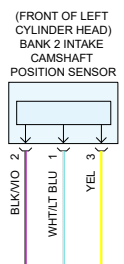
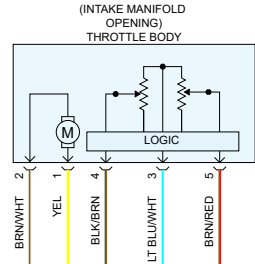

5492	GRN	1	SOL CTRL 2
5491	BLU	2	SOL CTRL 1
5298	LT GRN/BRN	3	EXHAUST SENS CTRL 2
5276	YEL	4	INTAKE SENS 2
5302	WHT/LT BLU	5	INTAKE SENS CTRL 2
6270	VIO/LT BLU	6	SENS 5V REF
6271	LT GRN	7	60X SENS SIG
2701	BRN/RED	8	TP SENS 5V REF
		9	
		10	
		11	
2126	BRN/LT BLU	12	IGN CTRL 6
2125	LT BLU/GRY	13	IGN CTRL 5
2124	YEL/LT BLU	14	IGN CTRL 4
2130	BLK/GRY	15	LOW REF BANK 2
7301	YEL	16	HIGH CTRL
4321	YEL/GRN	17	LOCK CTRL
587	GRY/GRN	18	SKIP/SHIFT SOL CTRL
5299	BLK/BRN	19	SENS LOW REF 2
5274	VIO/LT BLU	20	EXHAUST SENS 2
5303	BLK/VIO	21	CMP SENS LOW REF 2
6272	BLK/VIO	22	60X SENS LOW REF
3630	LT BLU/WHT	23	SENS (SENT1) SIG
2752	BLK/BRN	24	TP SENS LOW REF
		25	
		26	GEN TURN ON SIG
225	LT BLU/WHT	27	
2123	LT GRN/LT BLU	28	IGN CTRL 3
2122	LT BLU/WHT	29	IGN CTRL 2
2121	LT BLU/VIO	30	IGN CTRL 1
2129	BLK/LT BLU	31	LOW REF BANK 1
7300	VIO/BLK	32	LOW CTRL
428	LT GRN/LT BLU	33	PURGE SOL CTRL
197	BLU	34	COMMAND SIG
5297	GRY/YEL	35	EXHAUST SENS CTRL 1
5273	VIO/BLK	36	EXHAUST SENS 1
5296	BLK/GRY	37	SENS LOW REF 1
410	LT BLU	38	TEMP SENS SIG
7445	BRN/RED	39	PRESS SENS 5V REF
2917	BRN/RED	40	RAIL PRESS 5V REF
2919	BLK/GRN	41	SENS LOW REF
		42	
6755	BLK/LT BLU	43	PHASER Y LOW REF
5272	LT GRN	44	INTAKE SOL 2
5284	VIO/BRN	45	INTAKE SOL 1
6753	BLK/BRN	46	PHASER W LOW REF
		X3	

ENGINE CONTROL MODULE (UNDER COOLANT RESERVOIR)