

ENGINE CONTROLS

Engine Controls

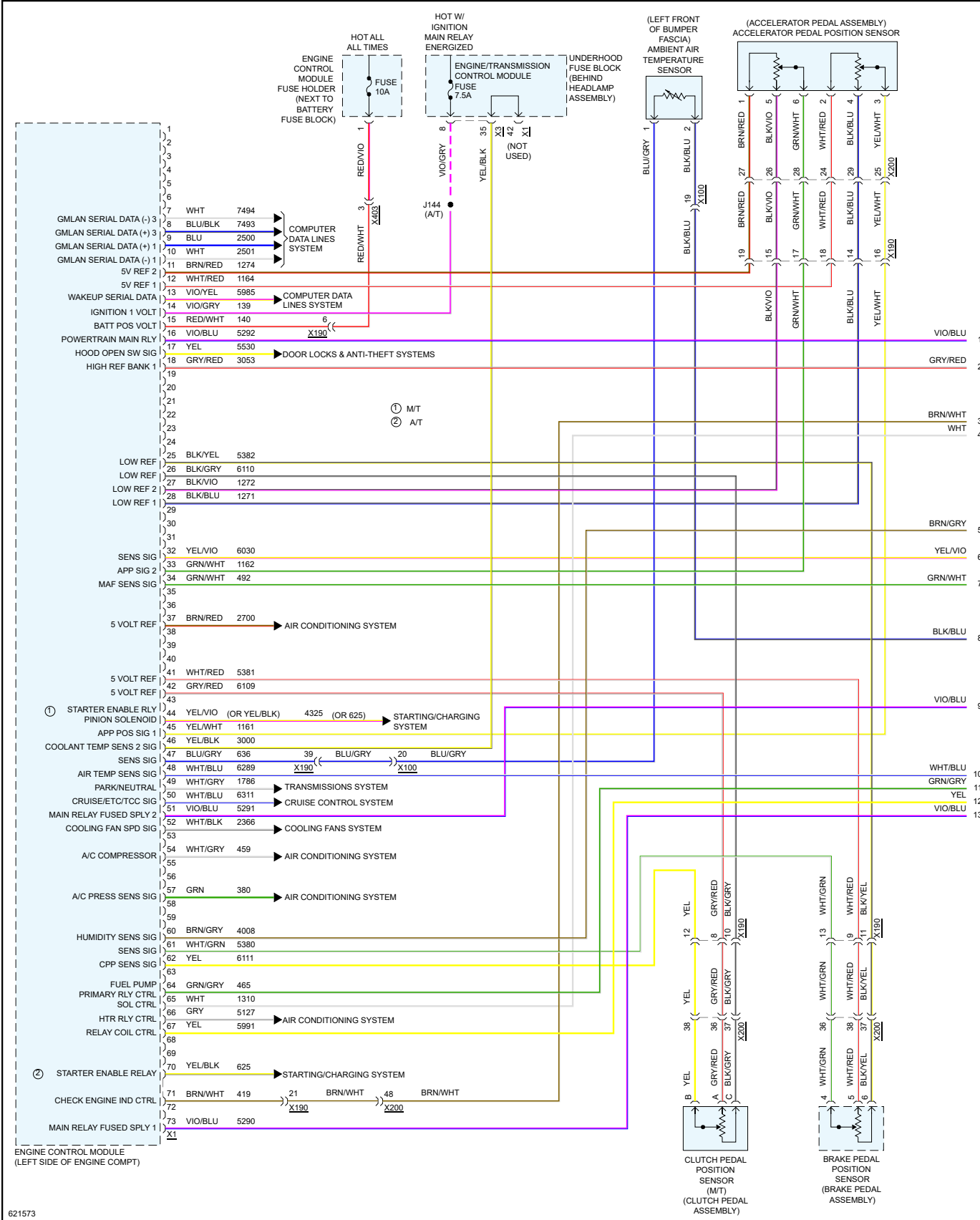

621573

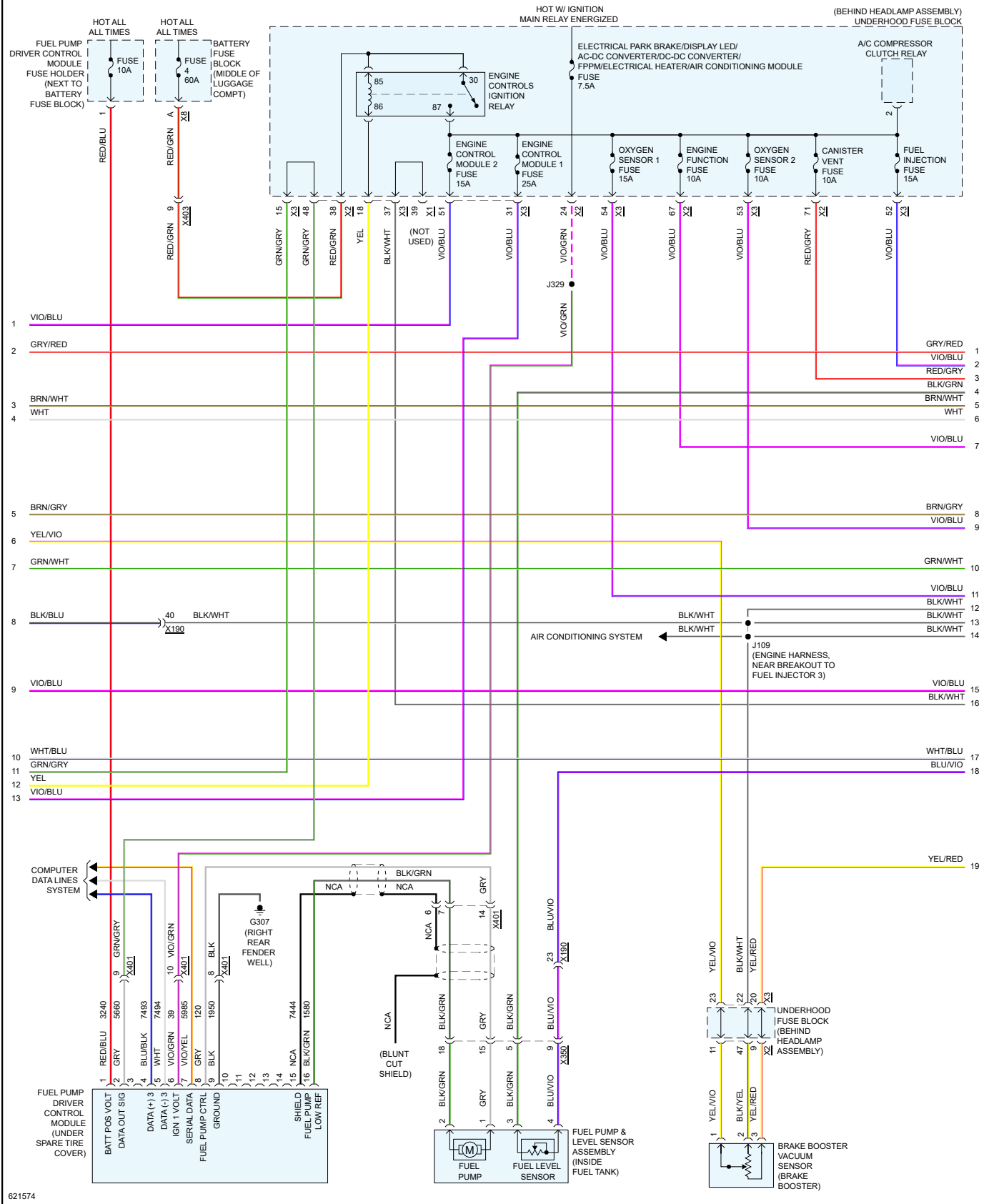

621574

(REAR OF ENGINE)
EVAPORATIVE
EMISSION PURGE
SOLENOID VALVE

(ON THE FUEL
INJECTOR HARNESS)
FUEL PRESSURE/
TEMPERATURE SENSOR

(TRANSMISSION
HOUSING)
(MT)
VEHICLE
SPEED SENSOR

(TOP OF INTERCOOLER
OUTLET)
TURBOCHARGER
BOOST SENSOR

(LEFT FRONT OF VEHICLE)
(IF EQUIPPED)
ACTIVE GRILLE AIR
SHUTTER 2 ACTUATOR
LOGIC

(LEFT FRONT OF VEHICLE)
ACTIVE GRILLE AIR
SHUTTER 1 ACTUATOR
LOGIC

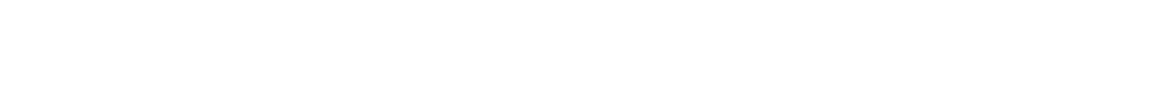
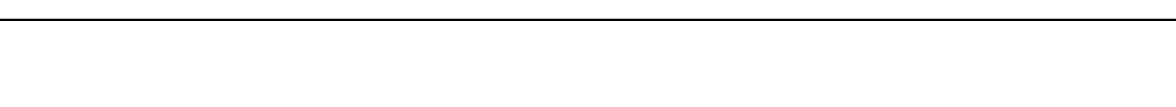
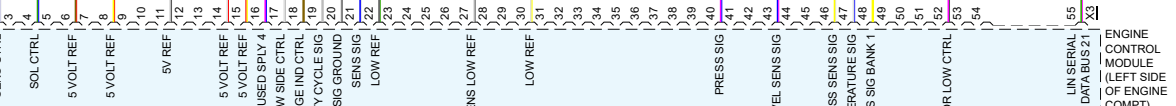
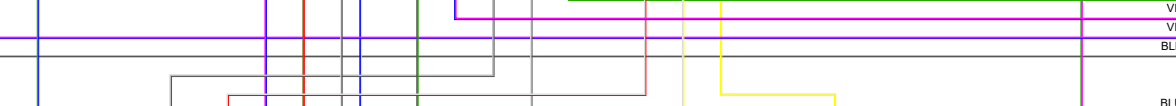
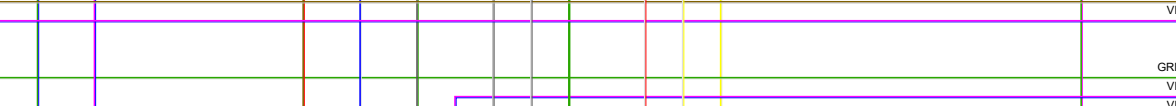
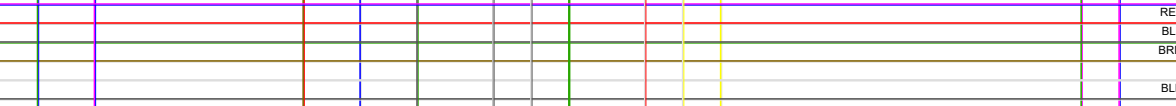
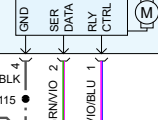
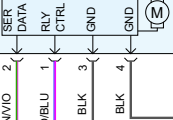
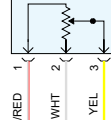
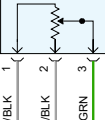
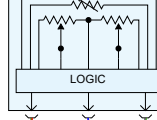
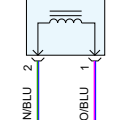

621575

(FRONT LEFT OF ENGINE)
TURBOCHARGER
WASTEGATE
SOLENOID VALVE

FUEL TANK
PRESSURE SENSOR

(FUEL LINE,
ABOVE FUEL TANK)
FUEL
PRESSURE SENSOR

INSTRUMENT CLUSTER

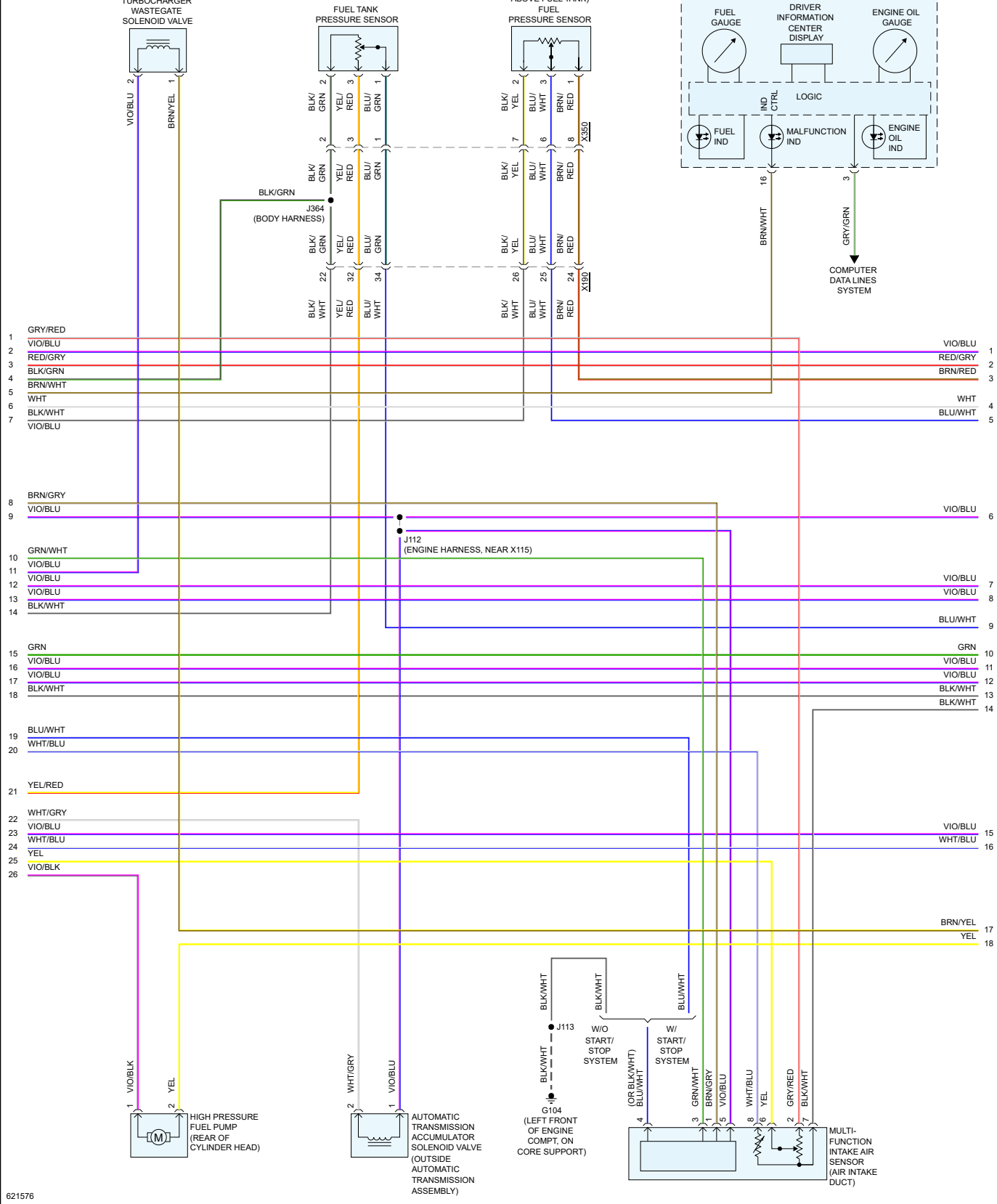
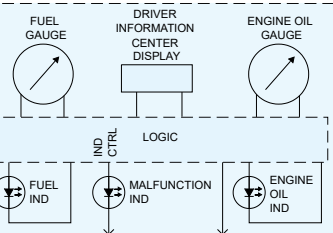

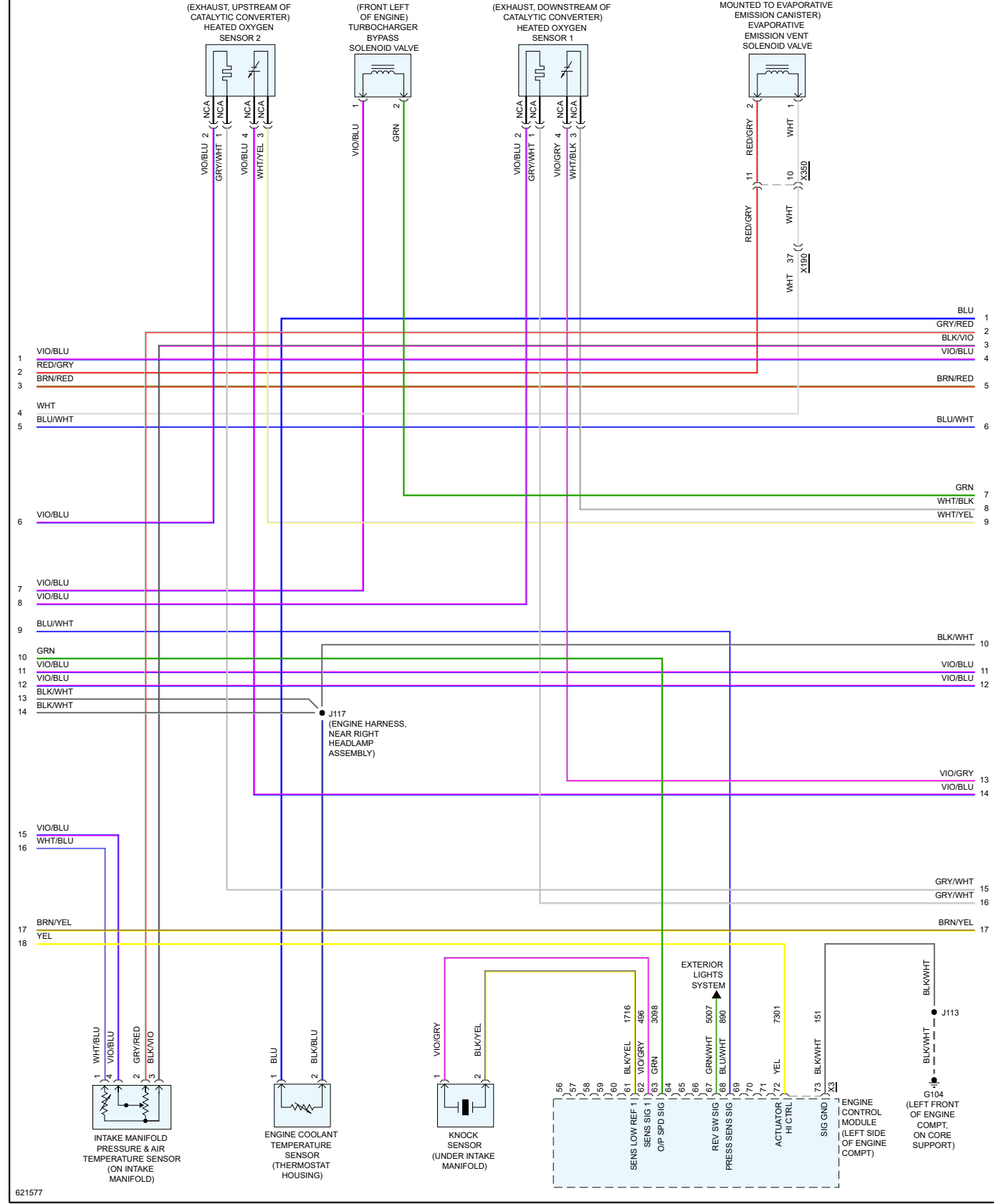

621577

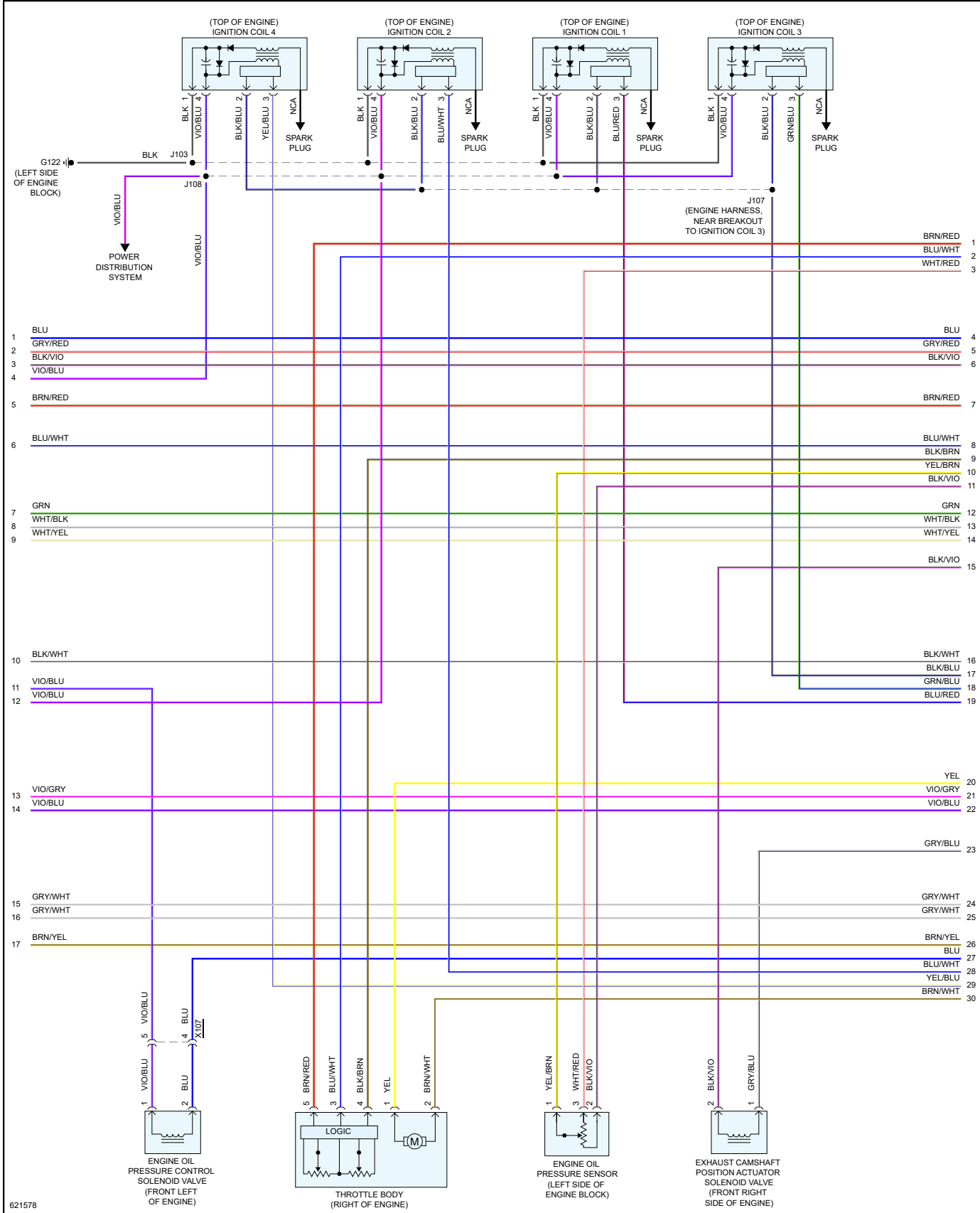

621578

(LOWER REAR OF ENGINE BLOCK)
CRANKSHAFT POSITION SENSOR

(REAR OF ENGINE)
INTAKE CAMSHAFT POSITION SENSOR

(FRONT RIGHT SIDE OF ENGINE)
EXHAUST CAMSHAFT POSITION SENSOR

