

TIGHTENING TORQUES

Part	Nominal torque	Products
Screw fastening damper to the crankshaft	450 Nm	LOCTITE 242
Screw fastening flywheel to crankshaft	91 Nm	
Solenoid valves' Screw fastening screw	10 Nm	
Screw fastening pump control gearing	23 Nm	
Oil filter cartridge	25 Nm	engine oil on gasket
Screw fastening piston cooling system multiple union (oil nozzles)	3 Nm	LOCTITE 242
Screw fastening RH head alternator	49 Nm	
Screw fastening LH head alternator	49 Nm	
Timing chain tensioner for camshaft axle control	40 Nm	
Screw fastening belt-tensioner pulley	49 Nm	
Screw fastening coils on head cover	10 Nm	
Screw fastening pumps to the sump	25 Nm	
Crankcase pumps fastening	25 Nm	
Screw fastening exchanger to crankcase	10 Nm	
Screw fastening variator oil pump	3 Nm	

Part	Nominal torque	Products
Screw fastening exhaust manifolds	25 Nm	
Screw fastening front cover to sub-crankcase-crankcase-heads	10 Nm	
Check valve on LH cylinder head	30 Nm	
Threaded union on delivery pump for fastening oil filter	60 Nm	
Mounting bracket - engine fastening	45 Nm	
Sub-crankcase - crankcase fastening (external seam)	10 Nm	
Chassis plate - bushing fastening	50 Nm	
Self-locking nut for fastening bushing	120 Nm	
Alternator cable - starter motor fastening	14 Nm	
Injectors to fuel pipes connection	30 Nm	
Pipe from accumulator to cylinder heads	22 Nm	
Union on heads and accumulator, for oil pipes running from accumulator and heads	27 Nm	
Threaded plug for clutch housing - crankcase oil hole	60 Nm	
Plug on oil tank suction screen	32 Nm	
Exhaust system thermocouples	10 Nm	
Lambda sensors	50 Nm	
Water temperature sensor	16 Nm	
Screw fastening injector rails to intake manifold	15 Nm	
Screw fastening detonation sensor	20 Nm	
Spark plug	10 Nm	Spark plug lubricant
"Torca" clamp for exhaust system	54 Nm	with spinner max 400 rpm
Screw fastening r.p.m. sensor	8 Nm	
Threaded plug on front cover for bleeding	15 Nm	

Timing variators	200 Nm	
Outlet union for water vapour from the exchanger	15 Nm	
Screw fastening hydraulic steering pump	25 Nm	
Screw fastening A.C. compressor	25 Nm	
Screw fastening auxiliary belt tensioners	25 Nm	
Screw fastening timing control transmission mount	6 Nm	LOCTITE 242
Screw fastening bushing for LH head tensioner	10 Nm	
Screw fastening gearing on timing variator	15 Nm	LOCTITE 242

Part	Nominal torque	Products
Screw fastening pipe running from the compressor to the condenser	50 Nm	
Screw fastening timing sensor and revolution sensor	8 Nm	
Screw fastening cylinder head cover	12 Nm	
Screw fastening fixed runner onto transmission	10 Nm	
Screw fastening fixed runner for timing system control	25 Nm	
Screw fastening pump control fixed runner	10 Nm	
Screw fastening moving runner for transmission	10 Nm	
Screw fastening timing system movable runner	25 Nm	
Screw fastening pump movable runner	10 Nm	
Screw fastening intake manifold to head	10 Nm	
Screw fastening oil delivery pipe to pump	10 Nm	
Threaded union on pipe from exchanger to oil tank	75 Nm	
Fastening on tank for oil delivery pipe to oil pump	78 Nm	
Clutch - flywheel engine fastening	18 Nm	
Threaded plug on cylinder head cover for timing inspection	50 Nm	
Screw fastening wiring cover	7 Nm	LOCTITE 242
Pump - inlet water cover fastening	10 Nm	
Thermal pressure gauge cover fastening	10 Nm	
Screw fastening engine electric earth	25 Nm	
Threaded union on fibre plenum chamber for brake servo vacuum	22 Nm	
Threaded union on oil tank in suction screen area	75 Nm	
Threaded plug for oil bleeding into the sub-crankcase	60 Nm	
Nuts for fastening oil suction screen onto tank	16 Nm	

Belt tensioner - crankcase fastening	25 Nm	
Nut for fastening sub-crankcase to crankcase in clutch housing area	10 Nm	
Screw for fastening mounting bracket to starter motor	10 Nm	LOCTITE 242
Nut for fastening bracket to starter motor	6 Nm	LOCTITE 242
Triple gearing retaining screw	25 Nm	
Fastening for gearing on exhaust camshaft	17 Nm	LOCTITE 242
Self-locking nut for fastening rubber bushing	5 Nm	LOCTITE 242
Threaded tapered plug on cylinder heads (M6)	7 Nm	LOCTITE 242
Threaded tapered plug on cylinder heads (M8)	10 Nm	LOCTITE 242
Threaded tapered plug on cylinder heads (M10)	32 Nm	
Electric oil pressure transmitter	40 Nm	

TOOLKIT

Specific tooling

Description	Code	
Wrench for fuel tank pump ringnut		900026390

REMOVING-REFITTING THE ENGINE

Removing the engine

- Remove the trim panels.



- Rotate the plastic fastening screws on the engine compartment fuse box cover by 90°, then remove the cover.



- Undo the two fastening screws on the engine compartment fuse box.



- Undo the three fastening screws and remove the engine compartment fuse box mount.



- Remove the windscreen wiper unit.
Removing-refitting the windscreen wiper unit

- Undo the two screws fastening the brake oil pan.



- Disconnect the two pipes for draining the water from the service pan.



- Detach the electrical connection.



- Undo the screws fastening the connected devices' pan underneath the windscreen.



- Undo the screws fastening the left-hand pan for the connected devices underneath the windscreen and remove the pan.



- Drain the air conditioning system using the specific tool connected to the system's valves.



- Disconnect the battery's negative terminal
- Undo the three fastening screws on the tunnel side valance panel, then remove the trim panel 1 as well.

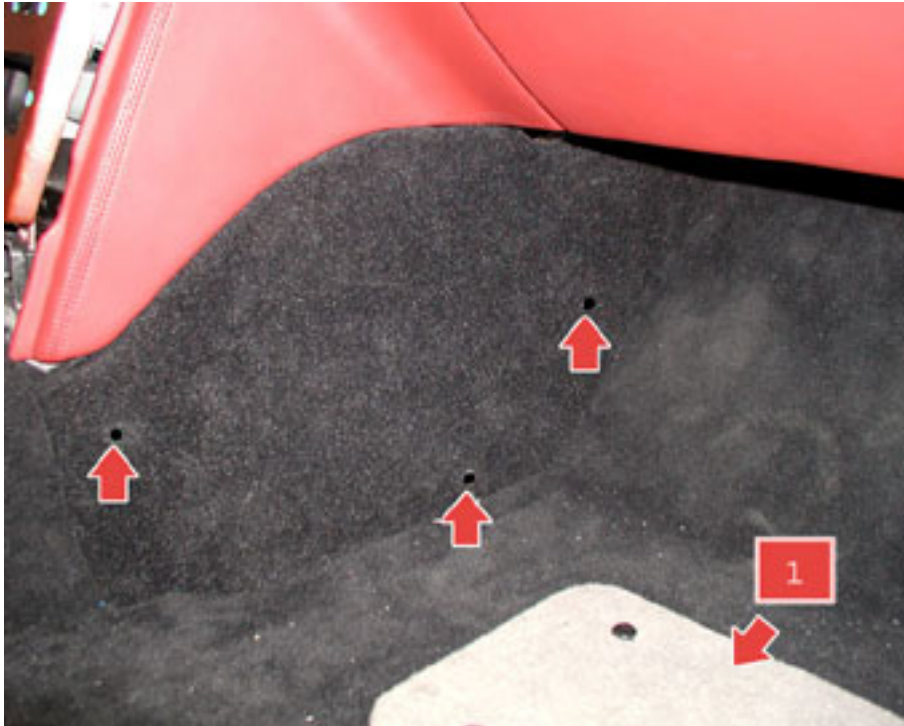

- Remove the snap-fitted trim panel on the door side.



- Lift the passenger compartment mat slightly.

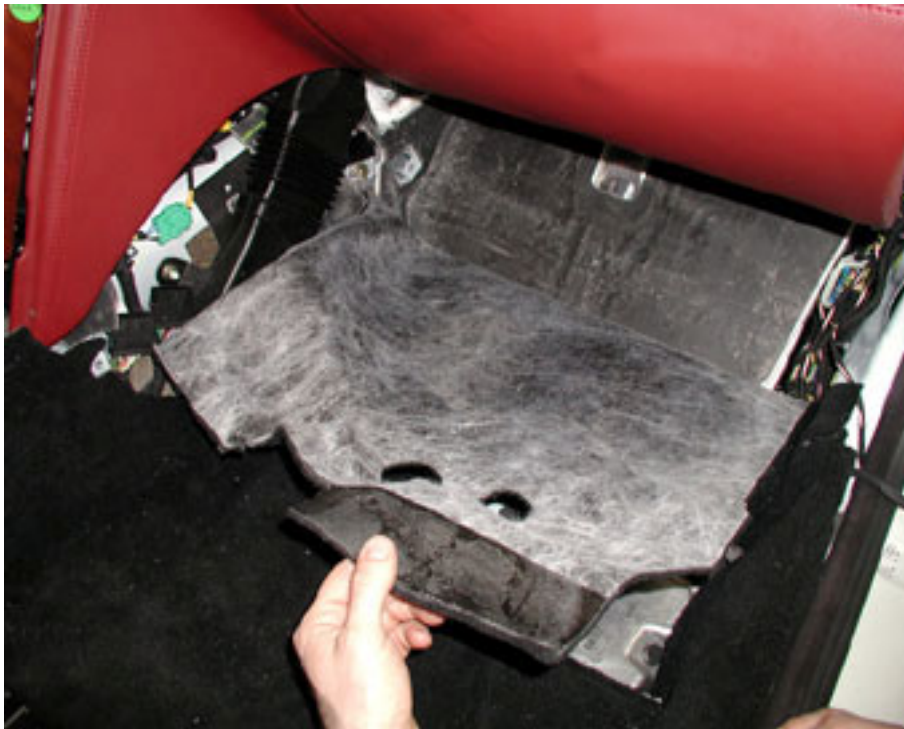

- Lift the guard partially.



- Undo the four fastening screws on the metal guard, then remove it.



- Undo the three fastening screws, detach the electric connection, then remove the bass box.

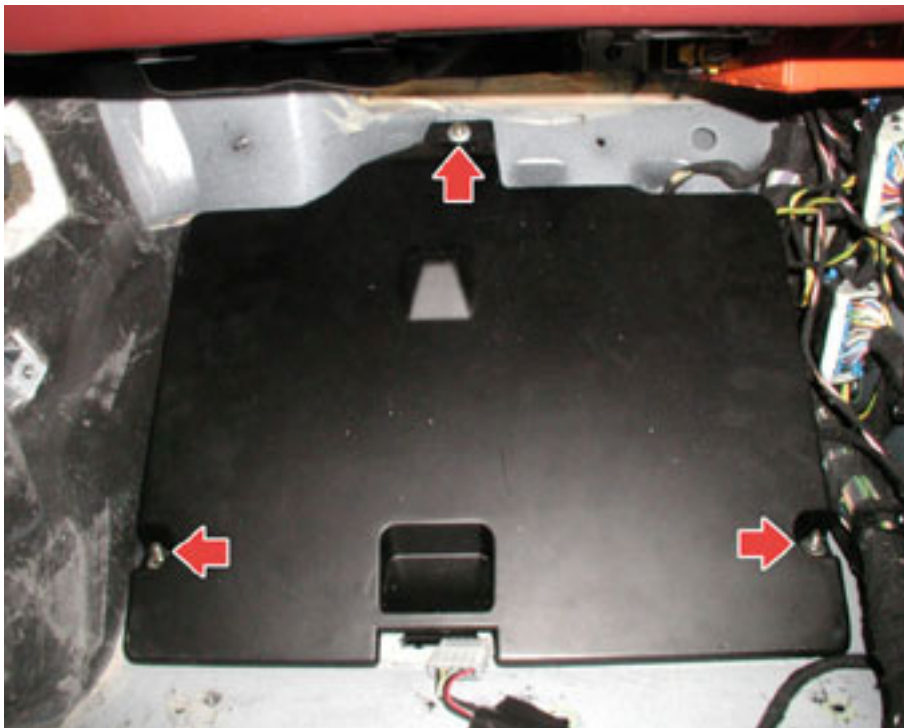

- Move the floor panel as far back as possible and undo the two screws and the two nuts on bracket for the engine control node compartment .

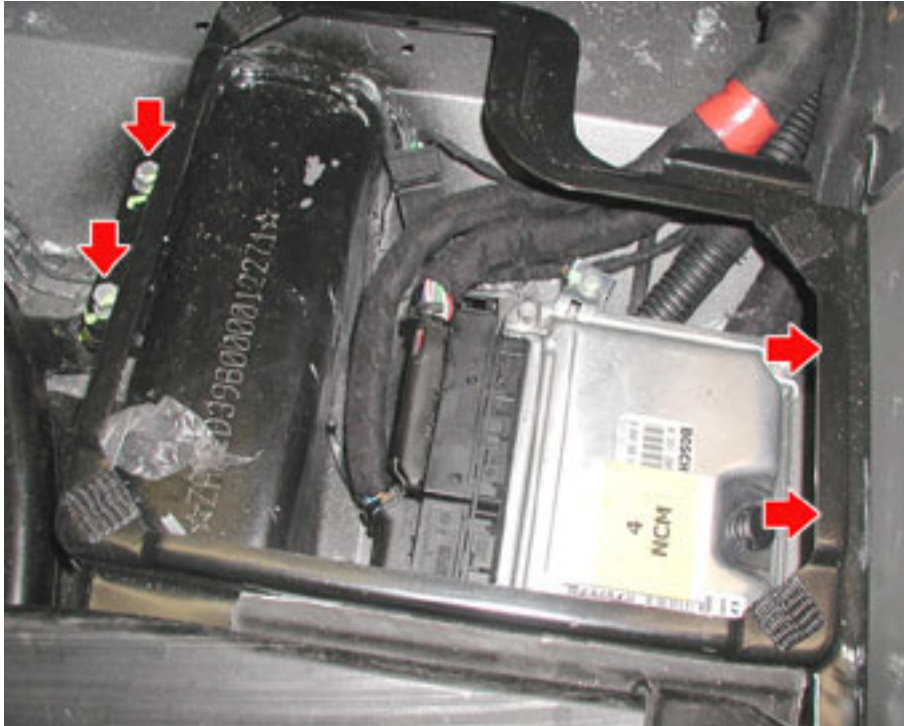

- Loosen the fastening screw and rotate the fastening clamp on the engine control node.



- Disconnect the two electric connections and remove the engine control node.



- Unscrew the nut and disconnect the earth cable from the bodywork, then detach the two electric connections.

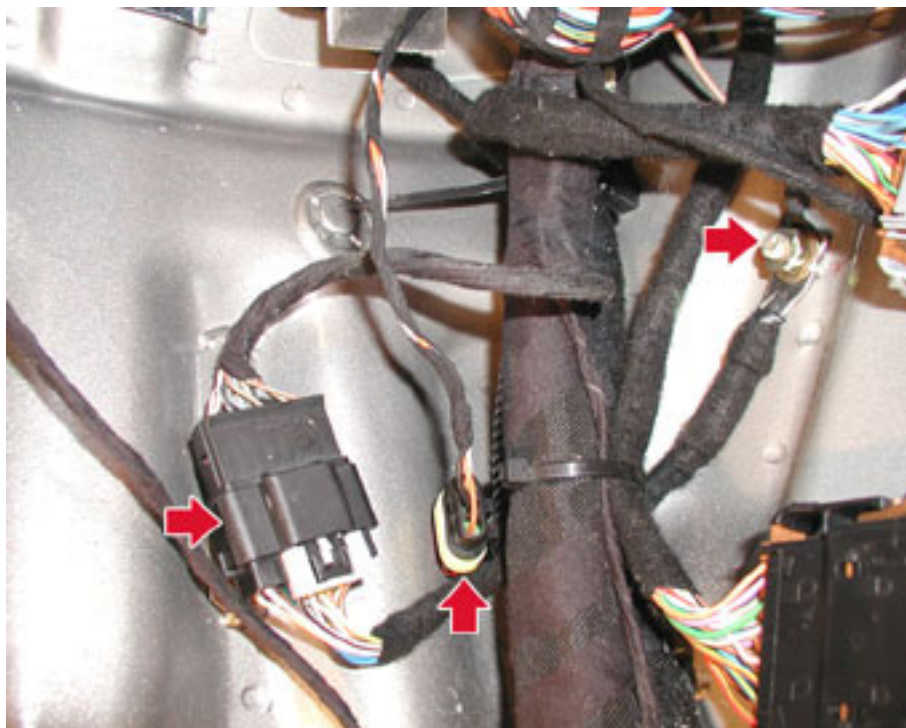

- Cut the plastic clamps and separate the engine wiring from the passenger compartment wiring.
- Detach the electric connection.



- Detach the two electric connections secured to the mudguard and the electric connection on the fuel vapour solenoid valve.



- Undo the fastening screws on the clamps fastening the engine wiring.

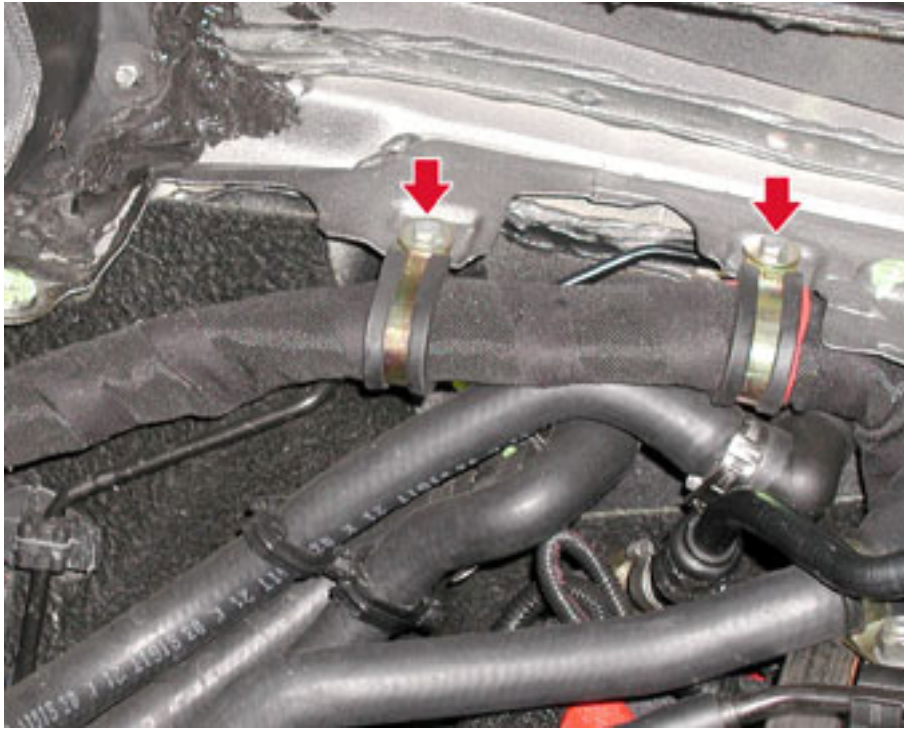

- Working from inside the engine compartment and from the passenger compartment, pass the engine wiring out through the hole on the passenger compartment/engine compartment partition panel, arranging it so it does not hinder subsequent operations.

N.B.

Slide the wiring out carefully so that it does not damage the electric connections and to prevent the wiring itself being cut by the sharp parts of the sheet.



- Place the vehicle on the hoist
- Remove the floor guard beneath the engine

Removing-refitting the engine floor guard

- Remove the exhaust tailpipes.

Removing-refitting the tailpipe

- Remove the gearbox.

Removing-refitting the gearbox

- Remove the transmission shaft.

Removing-refitting the transmission shaft

- Remove both front wheels.

Replacing the wheels

- Remove both the front wheelhouses.

Removing-refitting the front wheelhouse

- Undo the fastening screws on the reinforcement bracket and remove it (both sides).



- Undo the screws fastening the shock absorbers to the bodywork and detach the electric connections on the ABS sensors and on the acceleration sensors.

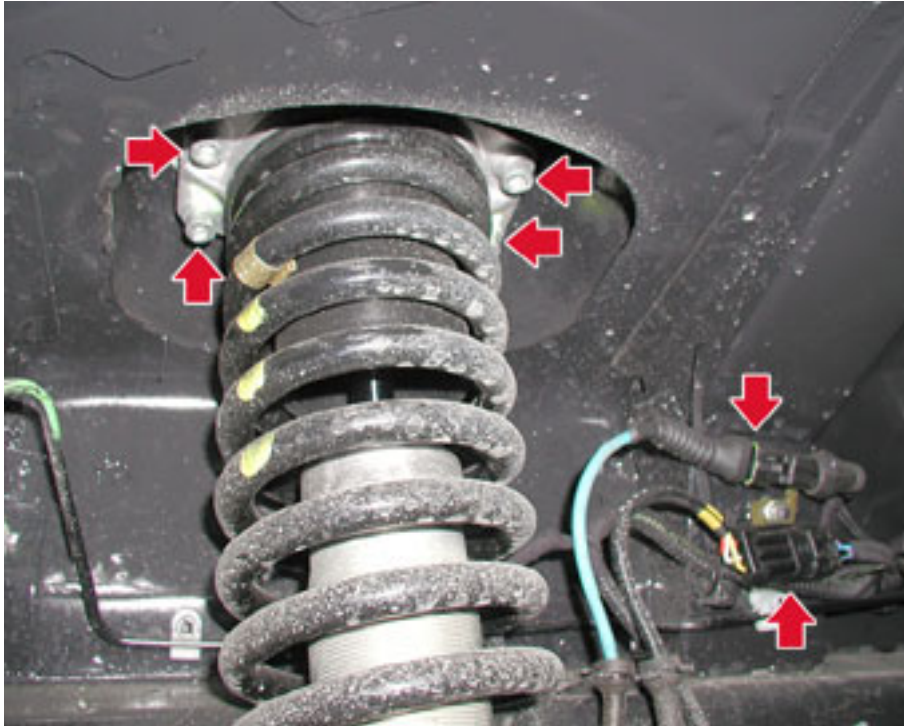

- Detach the electric connection on the brake pad wear sensor (this sensor is only found on the left-hand side of the vehicle)

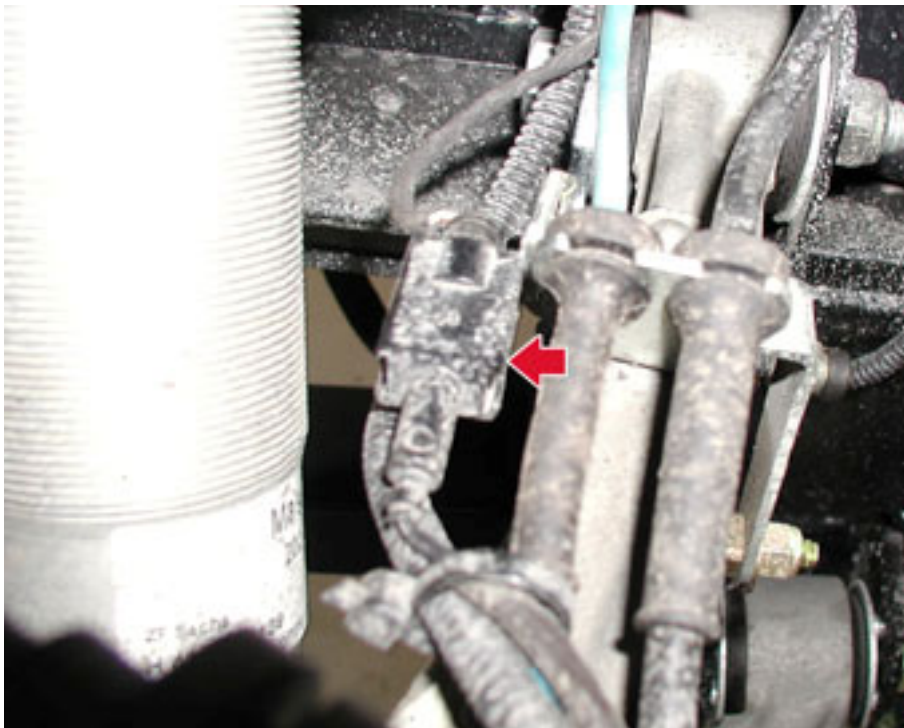

- Remove the lower screw fastening the shock absorbers on both sides.



- Detach the electric connection on the headlight adjustment potentiometer, on both sides of the vehicle.

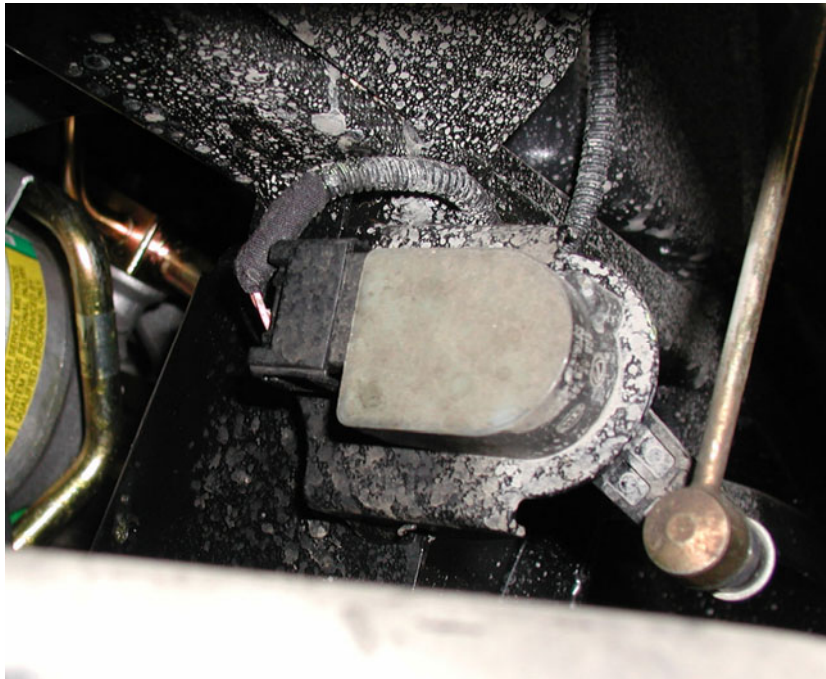

- Unscrew the nut fastening the cable for the headlights adjustment potentiometer, working on both sides of the vehicle.



- Undo the screw fastening the earth cable on the front right- and left-hand brake calipers



- Undo the two screws fastening the brake caliper to the pillar, then move it sideways, securing it with suitable means to ensure the weight of the caliper does not weigh down the oil line.



- Unscrew the upper fastening screw and loosen the lower fastening screw on the windscreen washer fluid tank.

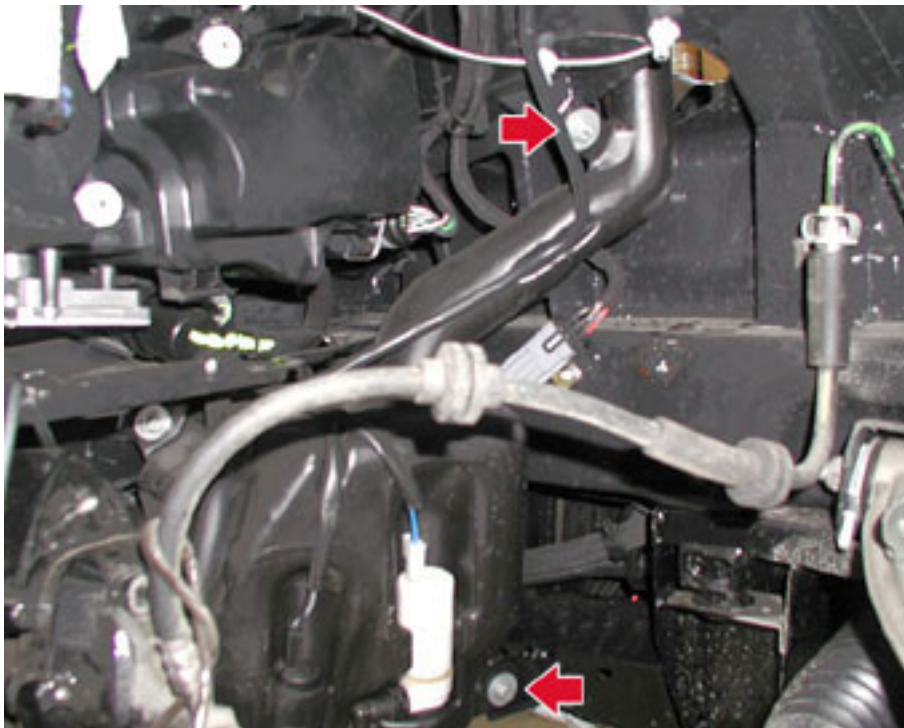

- Detach the electric connection on the air flow meter and release the two clips from the air filter housing.



- Remove the air flow meter fastening clamp.

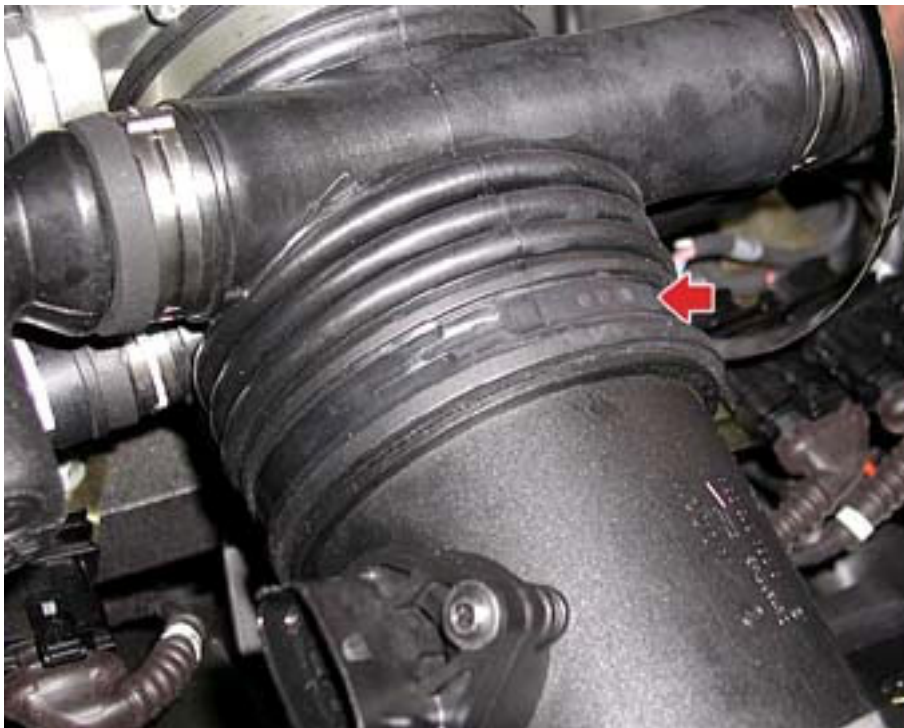

- Remove the air flow meter.



- Remove the two cold air intake lines.



- Release the clips fastening the cover to the air filter housing.



- Remove the cover and take out the air filter.



- Undo the screw fastening the air filter housing to the domes' bar.



- Remove the air filter housing.



- Disconnect the line from the union on the intake manifold.

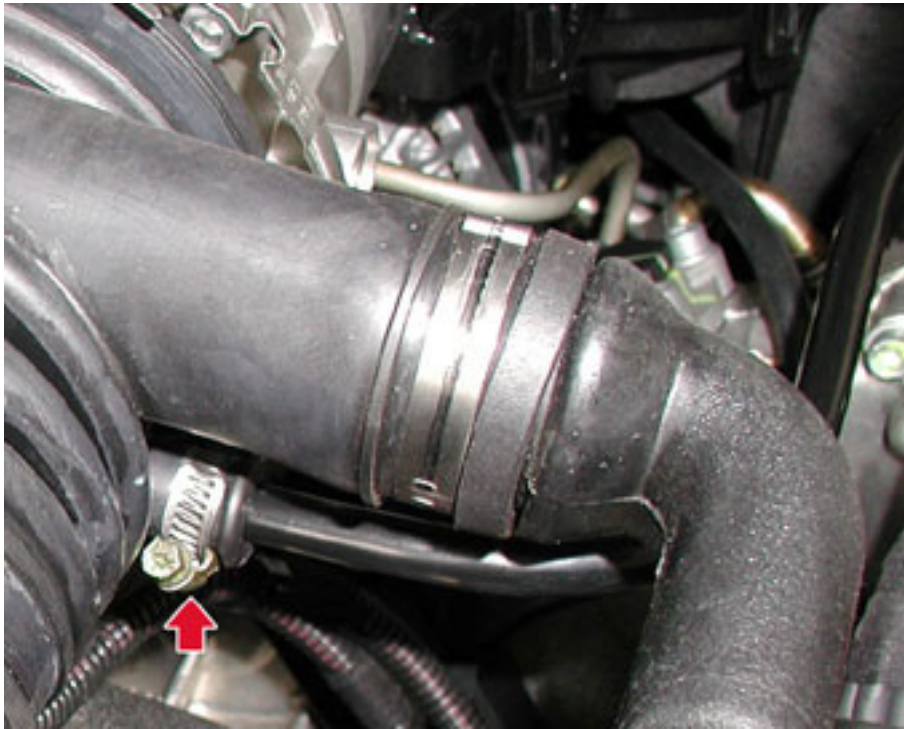

- Open the clamp and remove the union joining the intake manifold and air flow meter.



- Unscrew the fastening screw on the engine coolant tank.



- Disconnect the three oil vapour lines to the engine oil tank.

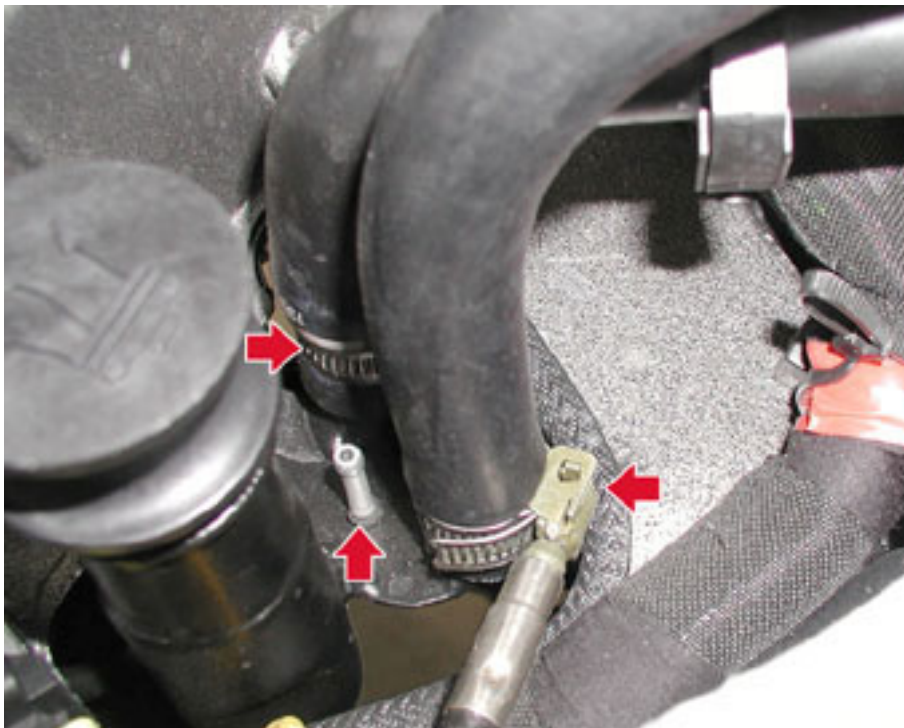

- Drain the engine cooling system by unscrewing the relative cap.

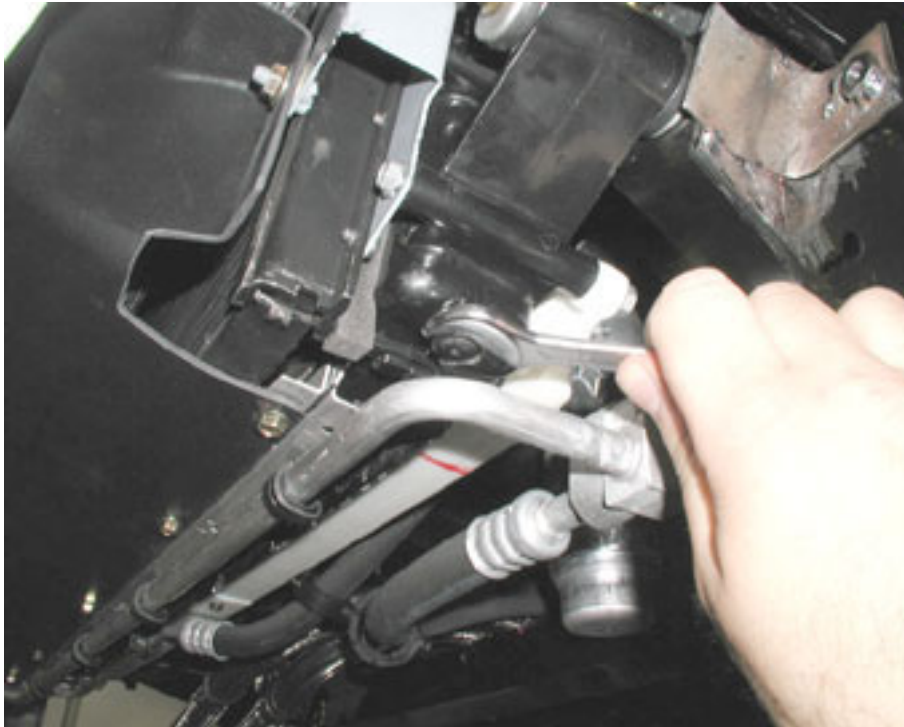

- Disconnect the ignition coil connections and undo the fastening screws on the connector fastening brackets.

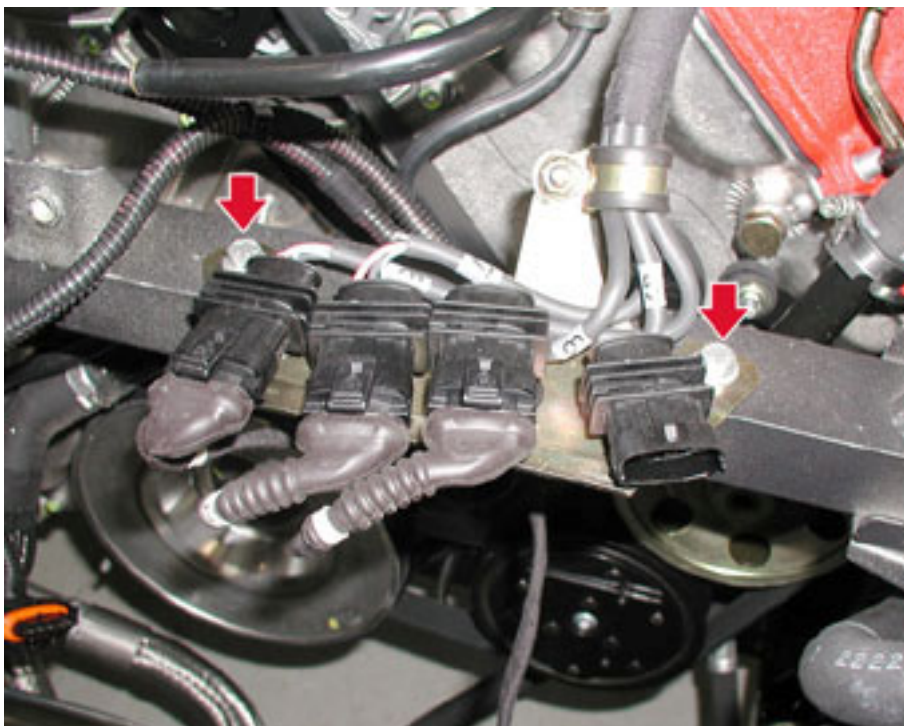

- Detach the electric connection on the additional air pump, then undo the fastening screws on the dome bar bracket.



- Undo the four fastening screws on the dome bar.

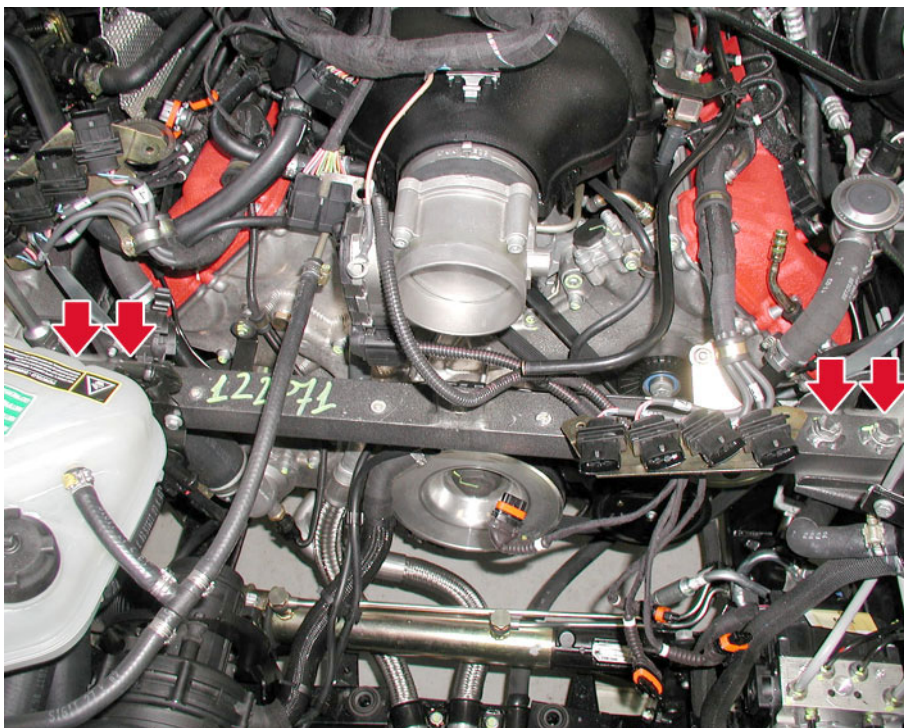

- Remove the dome bar from the engine compartment.



- Remove the front grille.



- Undo the lateral fastening screws on the radiator air duct.



- Undo the upper fastening screws on the radiator air duct.



- Remove the radiator air duct.



- Undo the fastening screws on the dual tone horns and release the wiring from the clamps fastening them to the bodywork.



- Detach the electric connection and remove the dual tone horns.



- Disconnect the two quick couplings on the fuel lines, then disconnect the water line from the pump.



- Disconnect the anti-evaporation system line from the intake manifold and release it from the plastic fastening clamps.



- Unscrew the nut fastening the starter motor cable.

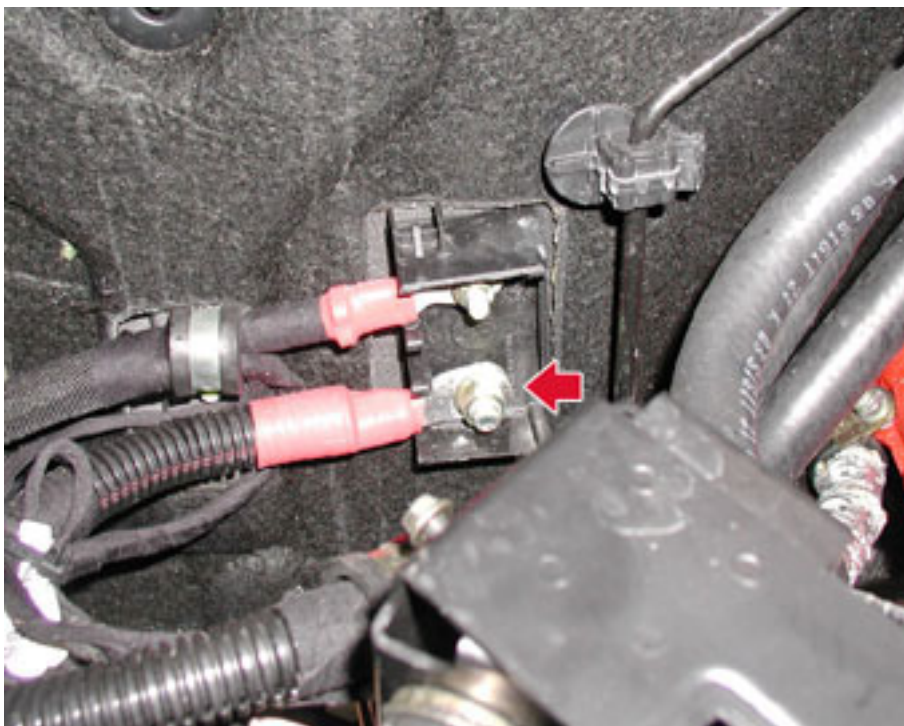

- Disconnect the water line running to the heating unit at the point shown.

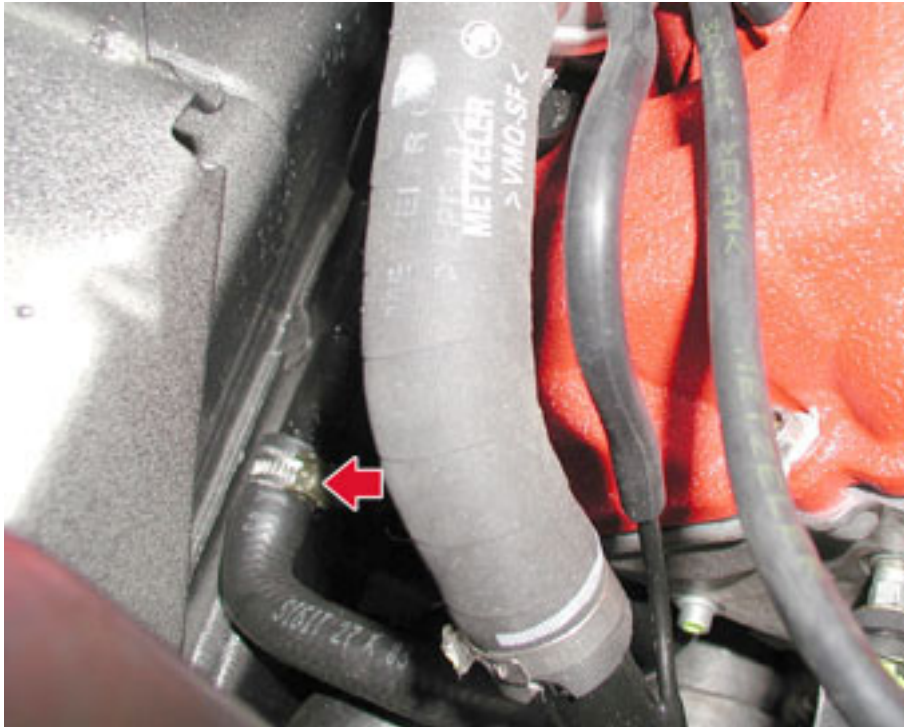

- Undo the fastening screw and disconnect the air conditioning system line from the dehydrator filter.

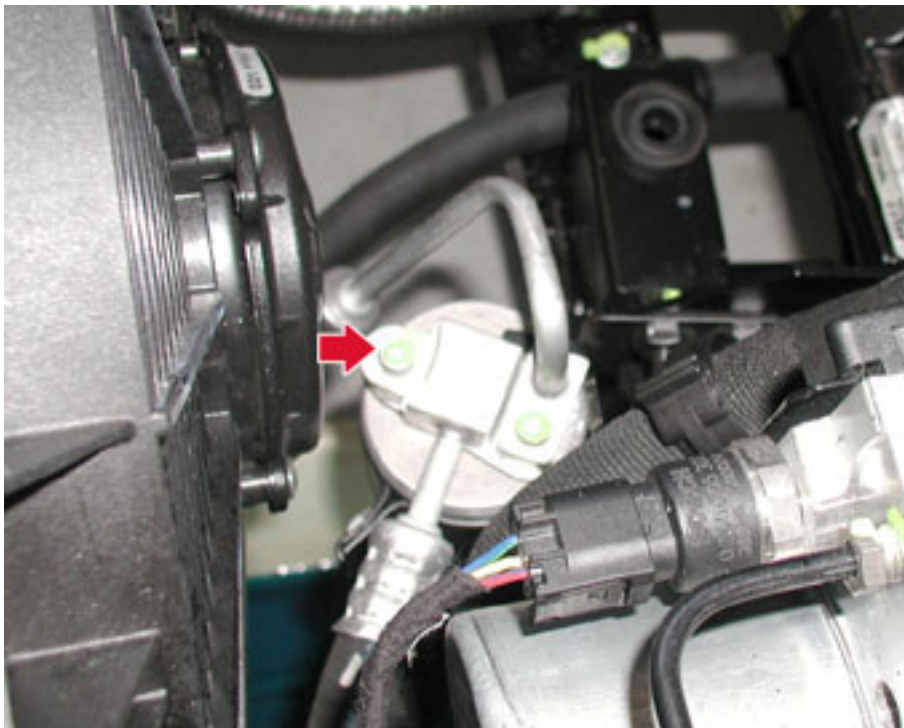

- Disconnect the air conditioning system line from the expansion valve.



- Undo the screw fastening the hydraulic steering oil tank to the relative mounting bracket.



- Detach the electric connection on the brake node (ABS-ASR-MSP ECU)
- Open the plastic clamp fastening the wiring and the hydraulic steering oil line.

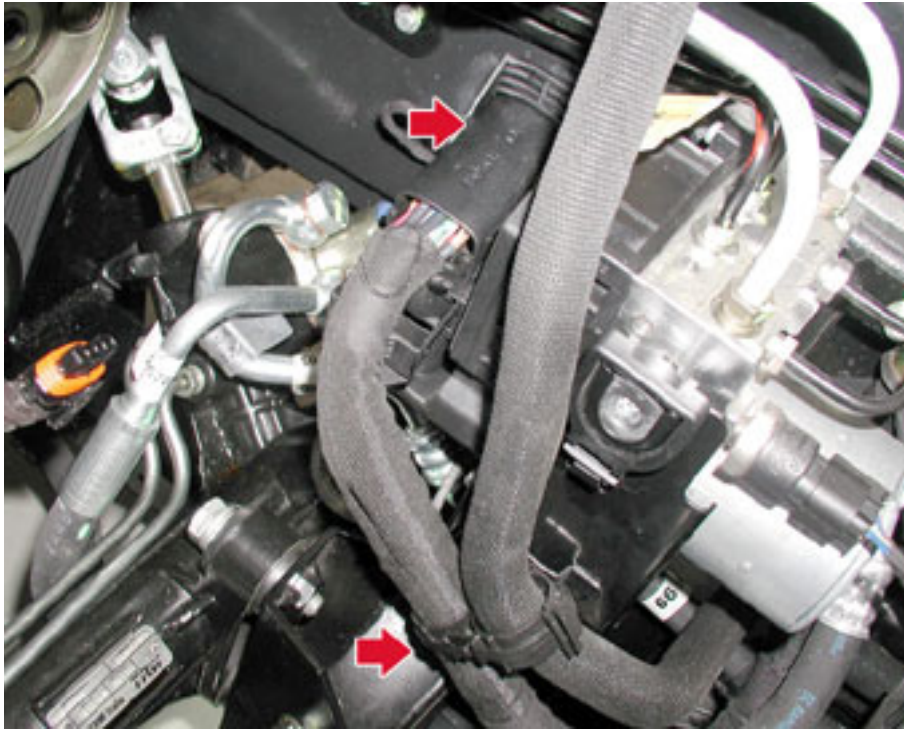

- Detach the electric connection and undo the screw fastening the steering column and the steering box.

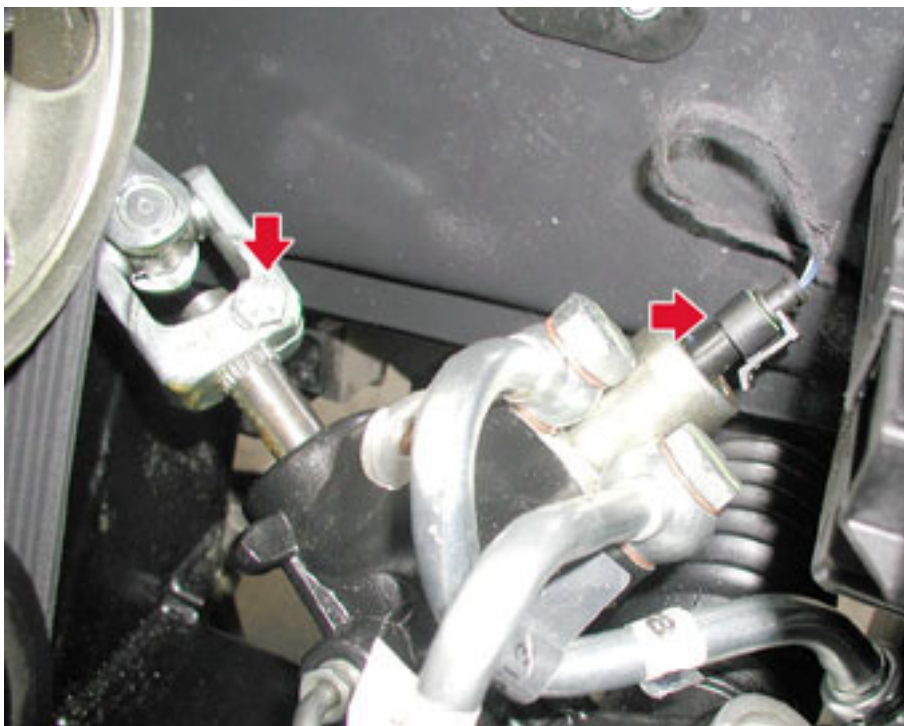

- Disconnect the vacuum line from the brake servo.



- Unscrew and remove the complete union, unscrewing it from the rigid line.

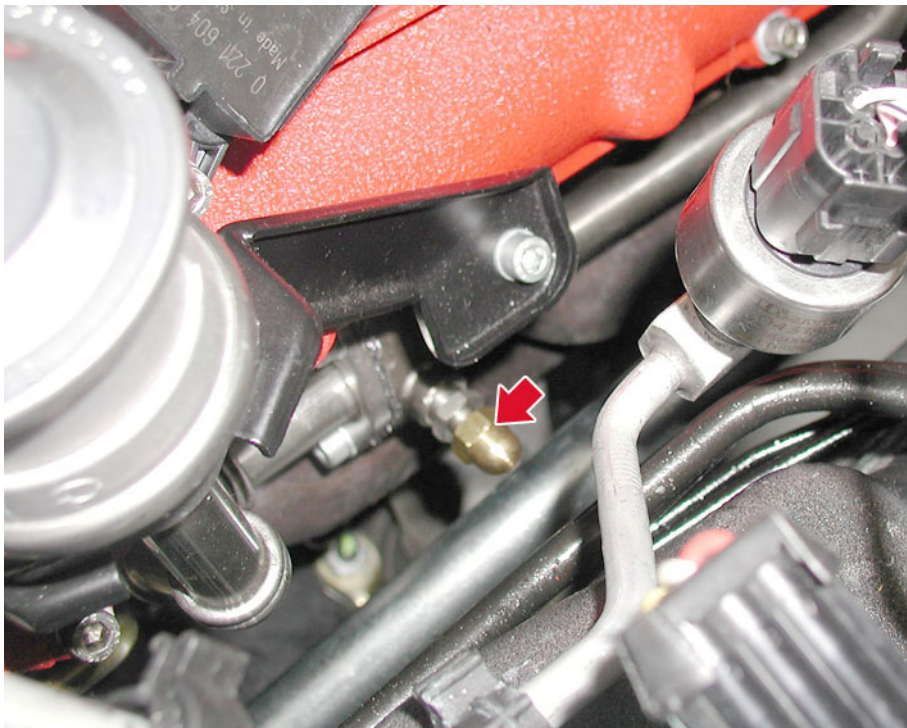

- Disconnect the two connectors for the suspension sensors, taking care to lift the safety tang.



- Unscrew the two upper nuts fastening the radiator.



- Unscrew the nut fastening the starter motor cable retaining clamp to the right-hand cylinder head cover.



- Lift the hoist and detach the electric connections on the electric fans.

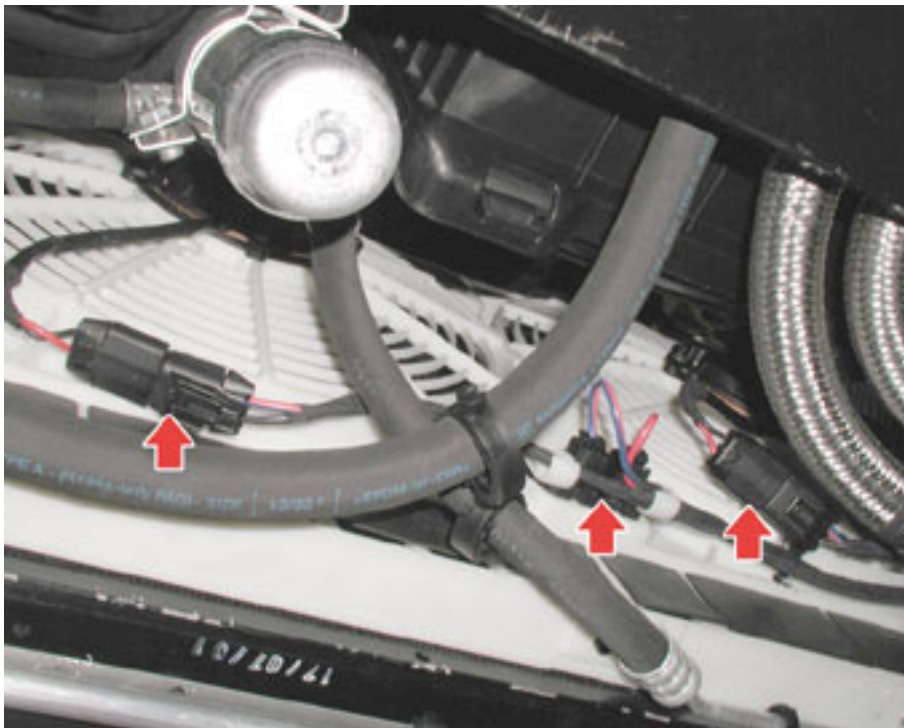

- Remove the cap to drain out the engine lubrication oil.



- Unscrew the two unions and disconnect the two engine oil lines from the tank.

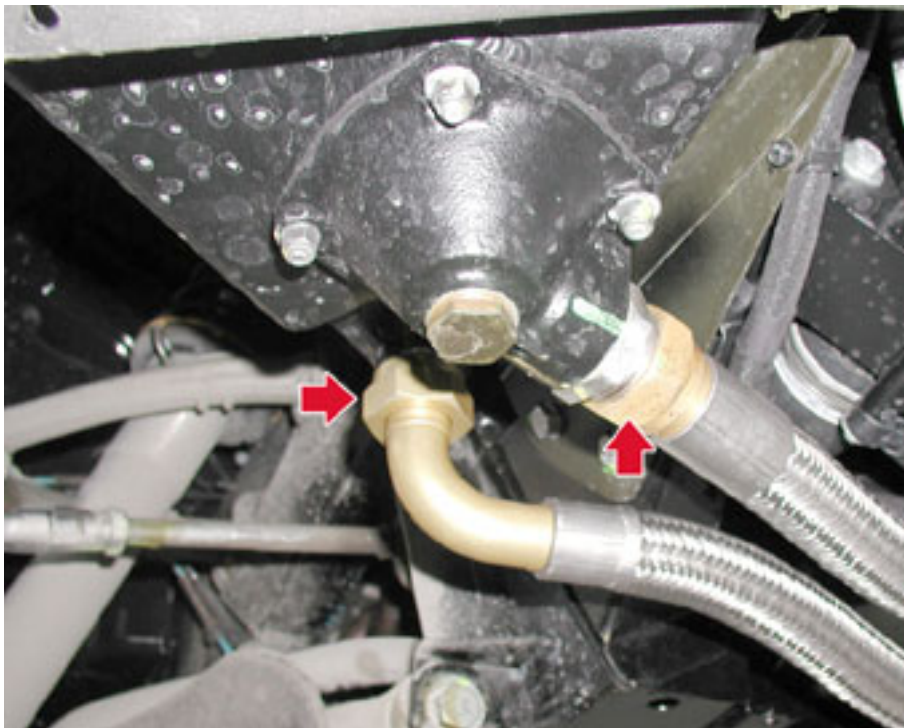

- Release the wiring from the clips secured to the chassis.

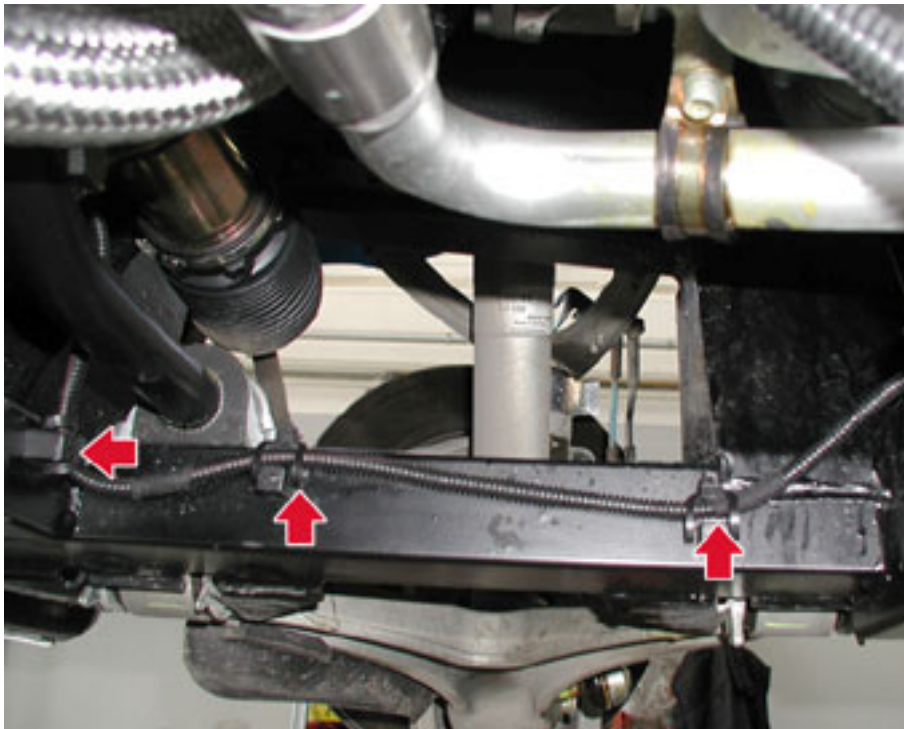

- Detach the electric connection for the solenoid valve controlling the secondary air system pneumatic actuator.

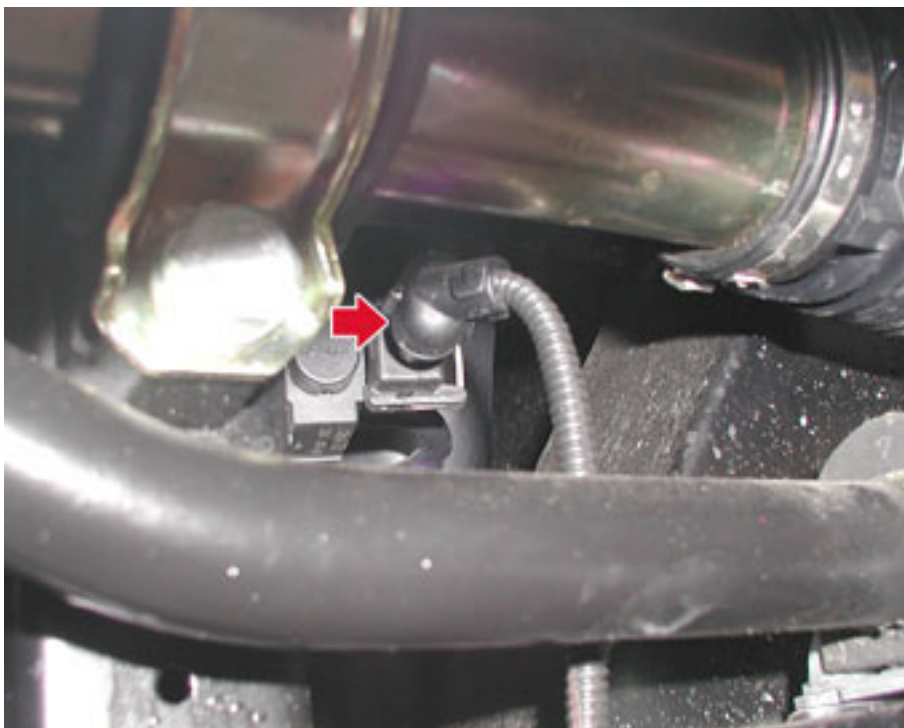

- Undo the screws fastening the engine oil tank to the chassis.

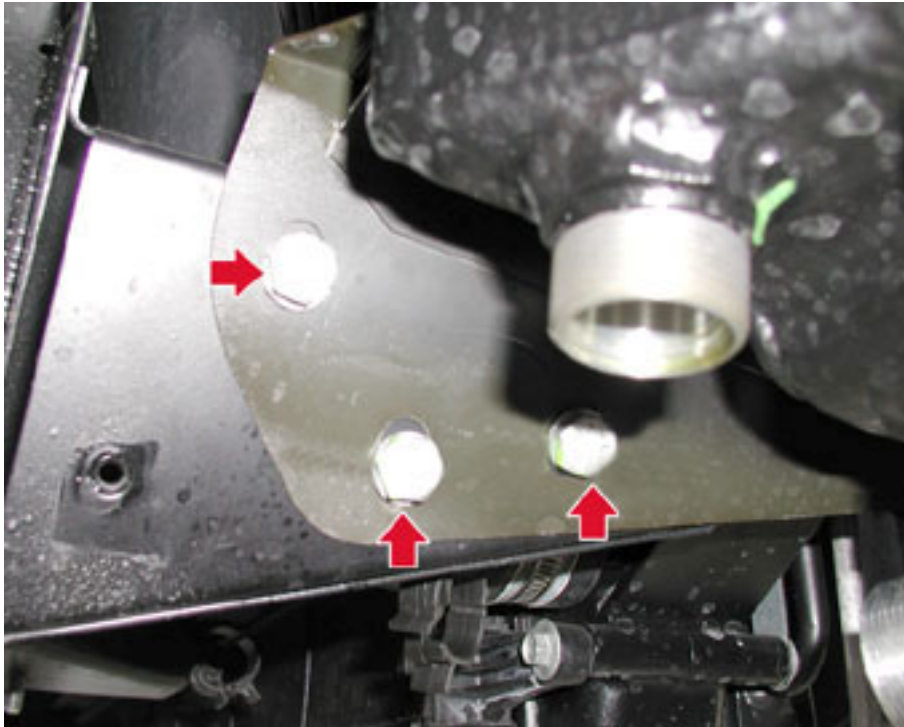

- Loosen the lower screws fastening the engine radiator.



- Undo the rear screws fastening the engine frame to the bodywork.



- Position a suitable supporting tool beneath the engine frame, to allow the engine to be removed.



- Undo the screws fastening the frame to the bodywork.

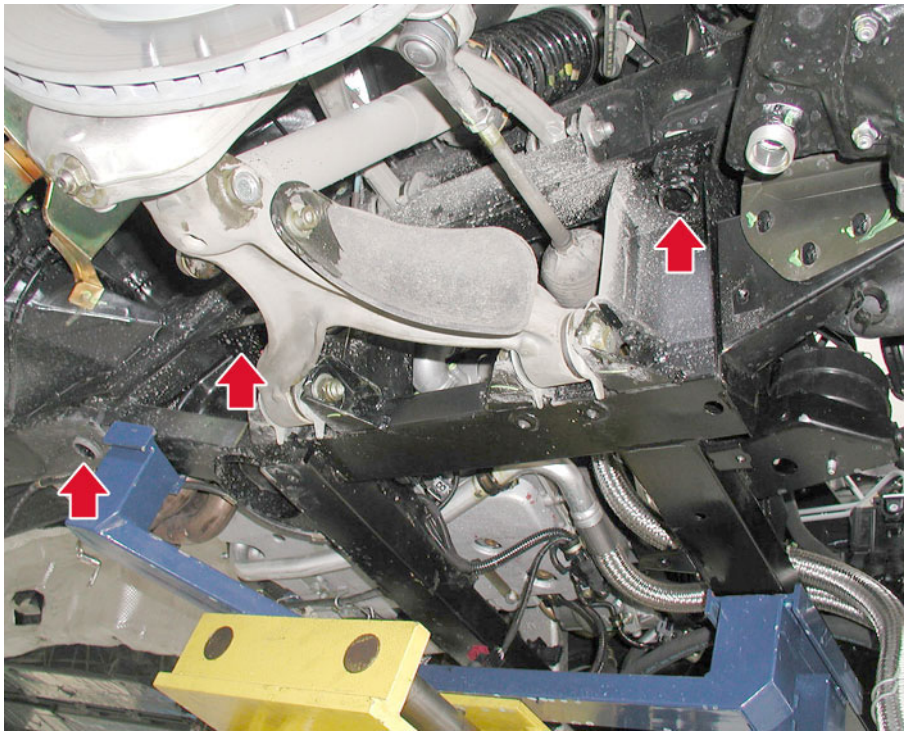

- Using the tool, lower the engine-frame assembly taking care not to damage the wiring, the electric connections, the steering column and any interfering parts fitted in the vehicle.



- Lift the vehicle and remove the engine, complete with frame.



- Unscrew the retaining clamp, disconnect the hydraulic steering oil inlet pipe on the pump, then drain the hydraulic steering oil system.



- Release the hydraulic steering oil delivery pipe from the clamp.

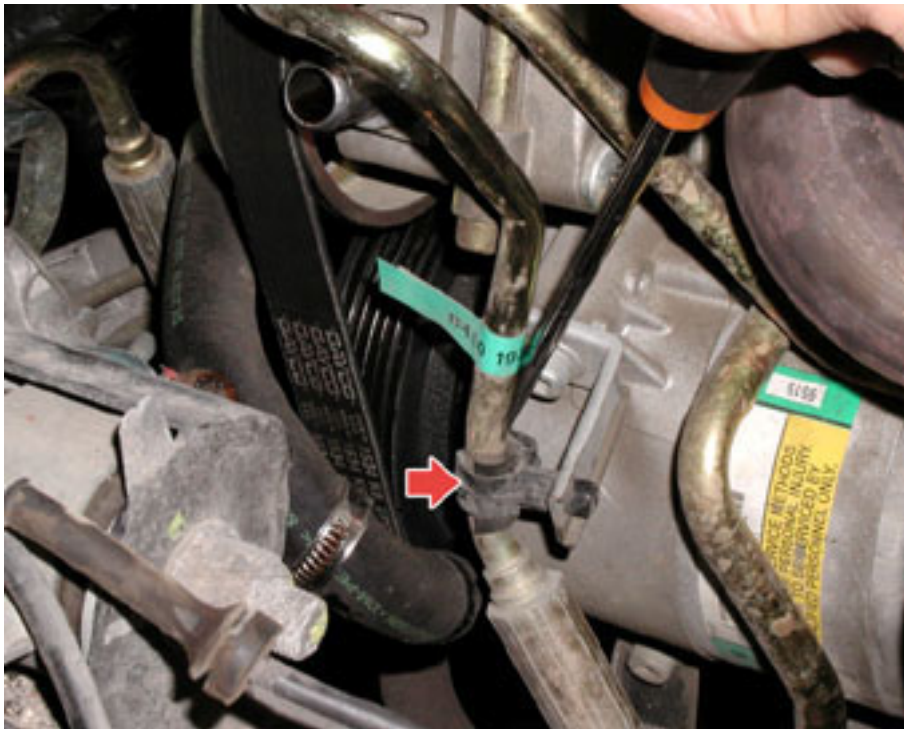

- Unscrew the hydraulic steering oil delivery pipe to detach it from the pump.

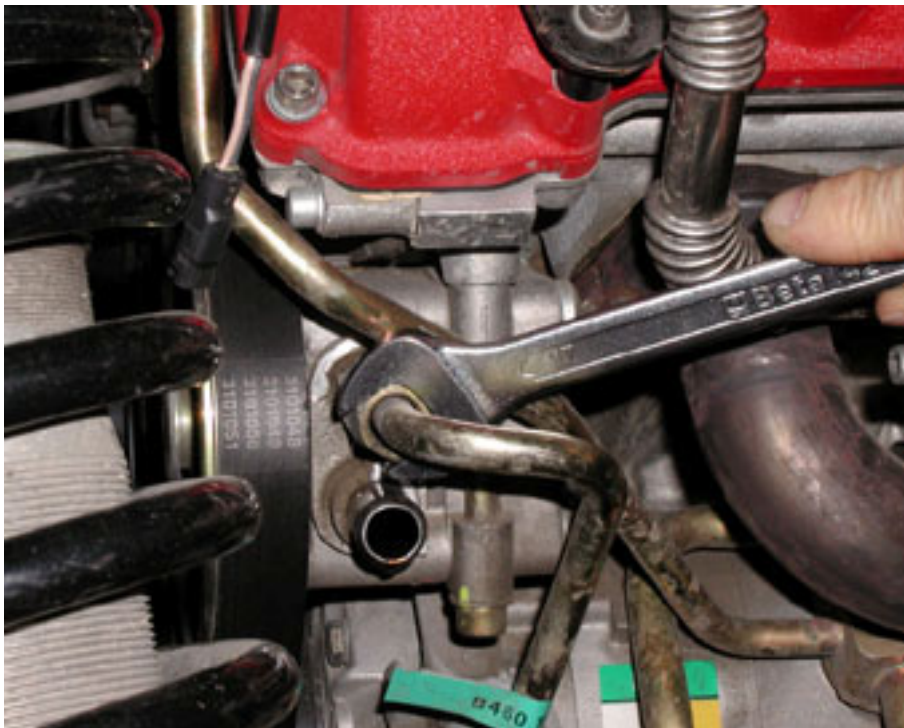

- Unscrew the clamp, then disconnect the engine coolant delivery pipe from the pump.

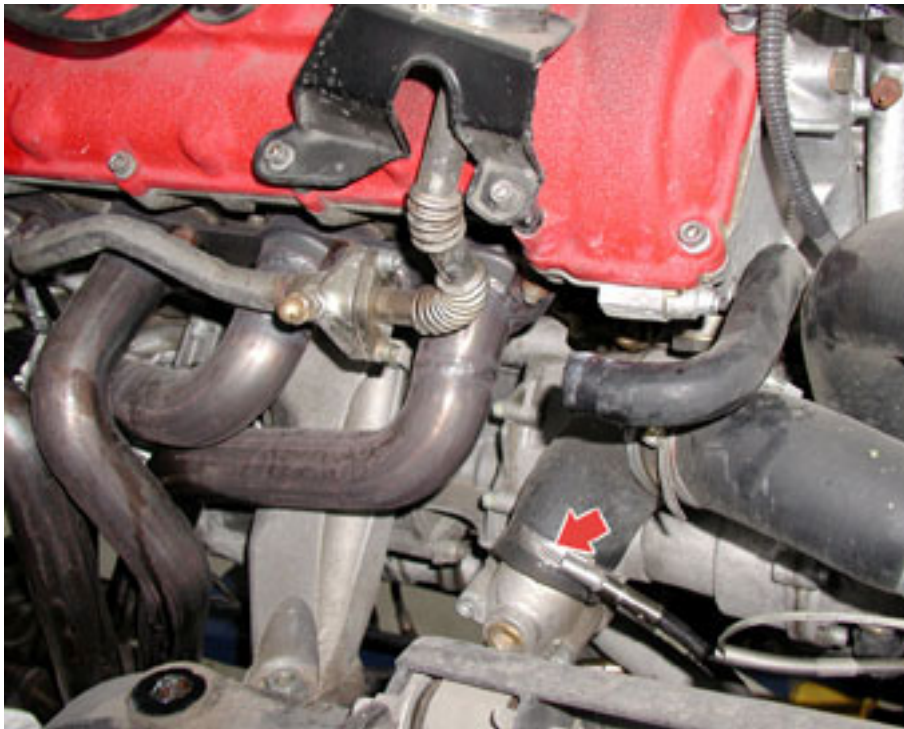

- Unscrew the fastening clamp, then disconnect the engine coolant pipe.



- Disconnect the engine coolant recirculation line.

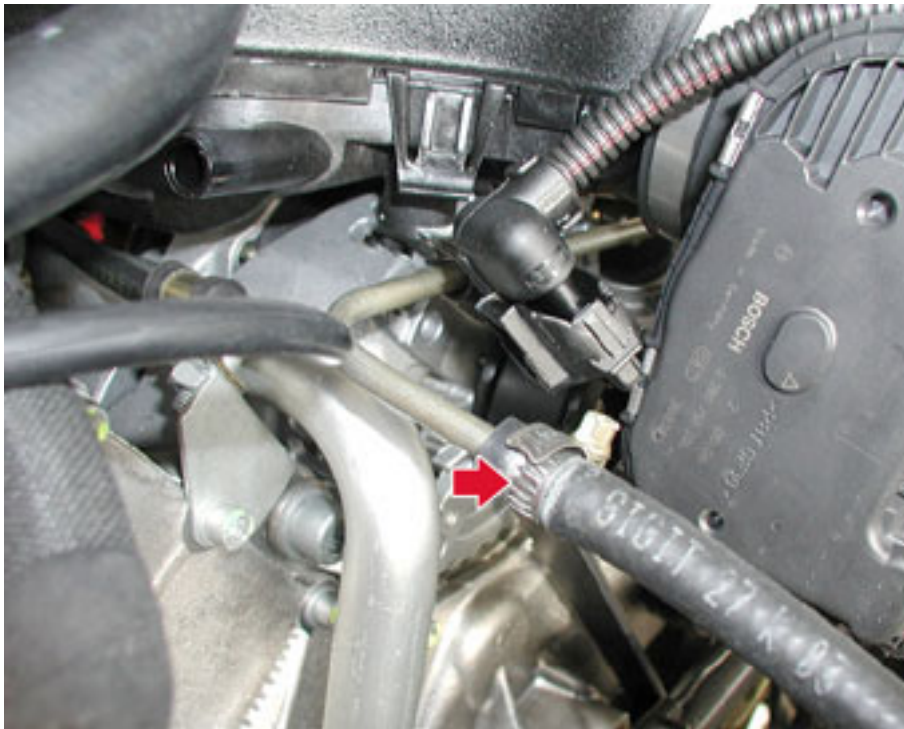

- After removing the clamp, disconnect the air pump pipe.

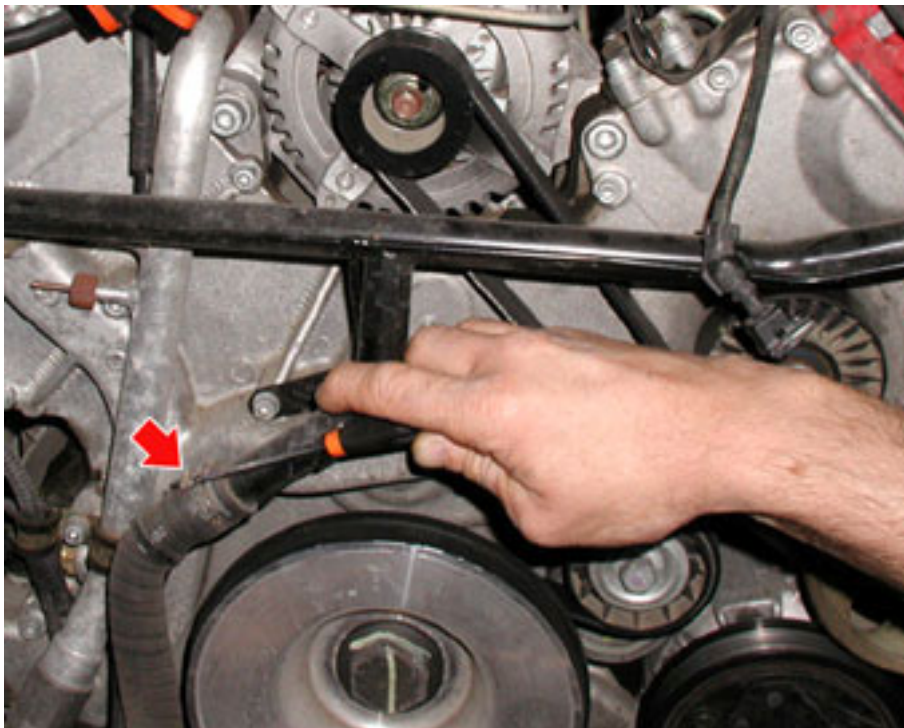

- Disconnect the two small pipes.

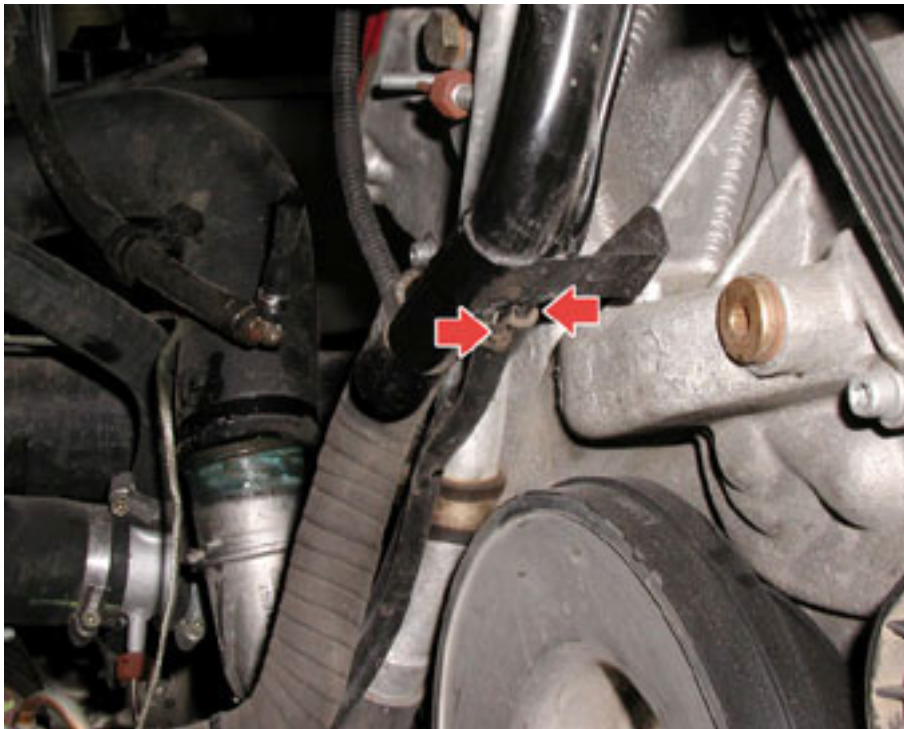

- Undo the nut fastening the air conditioning system pipe.



- Unscrew the two nuts fastening the engine to the mount (one per side).



- After suitably harnessing the engine, remove it with a hydraulic lift.



Refitting the engine

- Fit the engine on the frame using a hydraulic lift.
- Tighten the two nuts fastening the engine to the mount (one per side) to a torque of **120 Nm**



- Connect the air conditioning system pipe and tighten the fastening nut.

N.B.

Replace the rubber gaskets on the two lines.

- Connect the rubber unions to the secondary air system rigid lines.
- Connect the engine coolant recirculation line.
- Connect the two engine coolant lines to the pump.
- Tighten the union joining the power steering box delivery line to the pump to a torque of **35 Nm**.

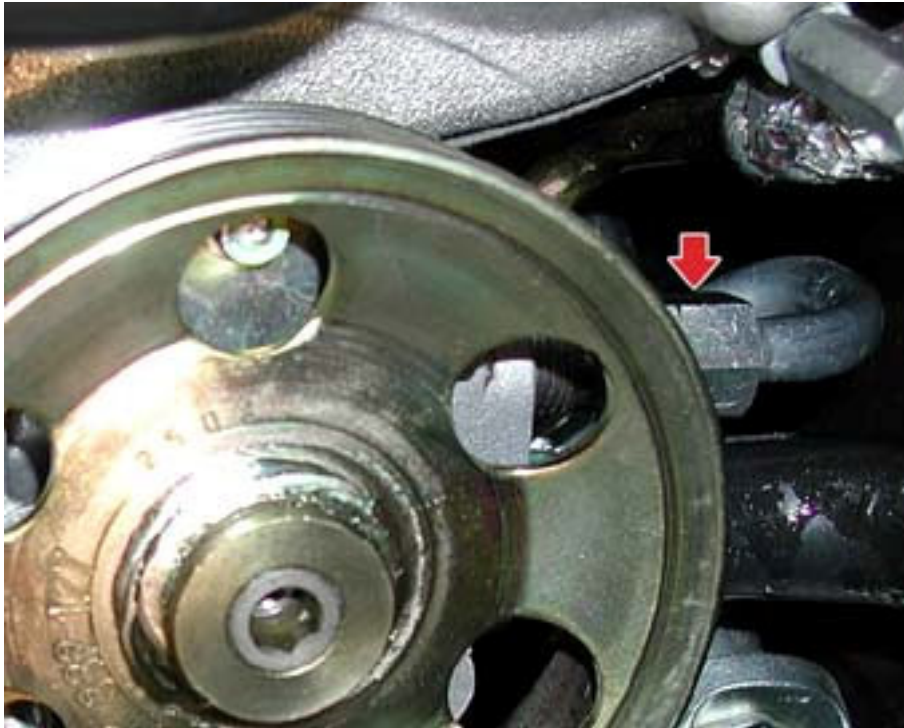

- Connect the rubber hose to the hydraulic steering pump.



- Position the engine - frame assembly beneath the vehicle, lower the hoist, check the frame is aligned with the respective holes, then lift the tool and move the frame so that it is touching the bodywork.



- Tighten the screws fastening the frame to the bodywork to a torque of **123 Nm**.

N.B.

Replace the screws fastening the frame to the bodywork with new screws.

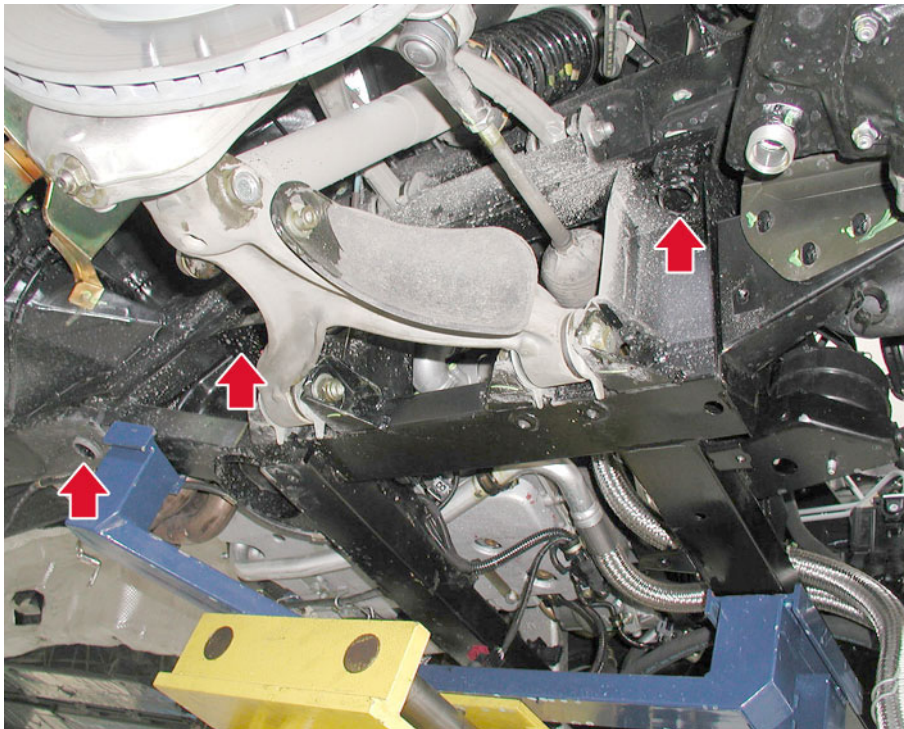

- Remove the engine supporting tool and tighten the rear screws fastening the frame to the vehicle bodywork to a torque of **123 Nm**

N.B.

Replace the screws fastening the frame to the bodywork with new screws.

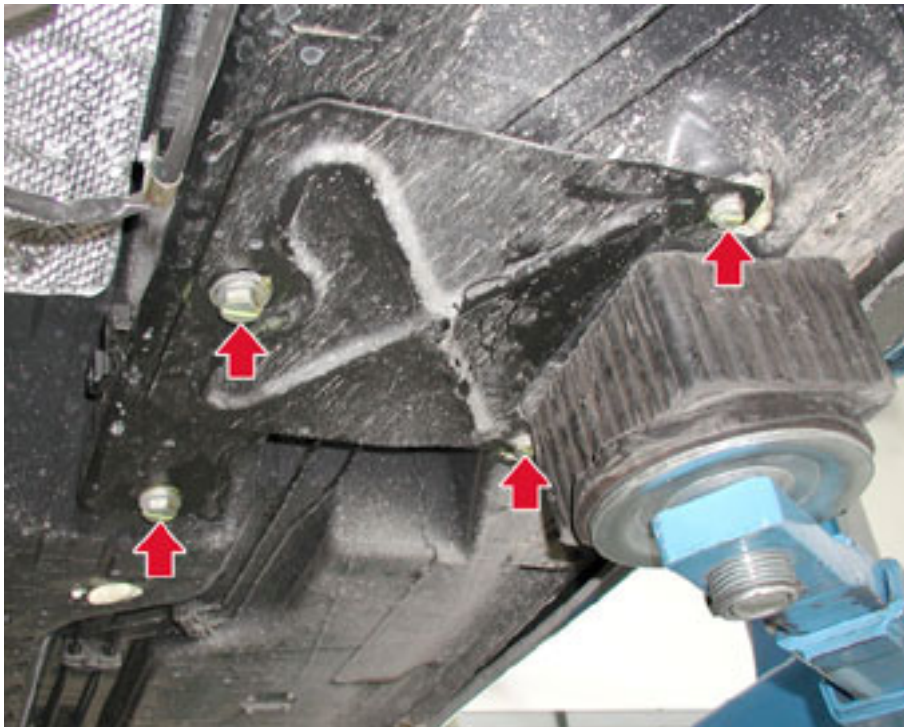

- Tighten the lower fastening screws on the radiator.



- Tighten the screws fastening the engine oil tank to the frame to a torque of **25 Nm**.

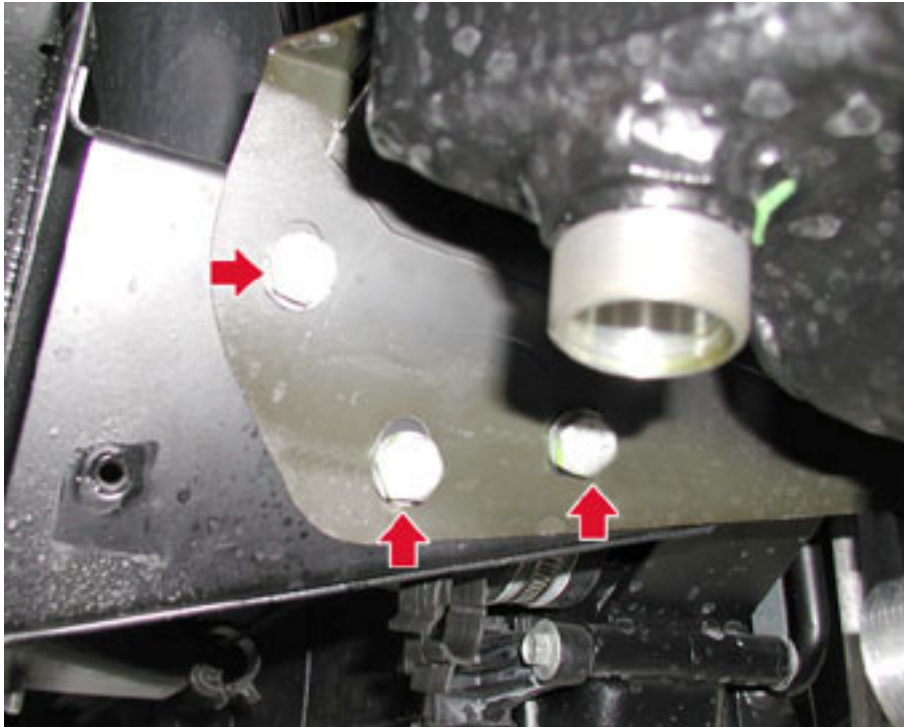

- Attach the electric connection on the secondary air system pneumatic actuator control solenoid and fasten the relative electric wiring to the frame.
- Tighten the unions on the two oil lines on the engine oil tank.
- Attach the two electric engine fans' electric connectors.
- Tighten the nut fastening the starter motor cable retaining clamp to the right-hand cylinder head cover.
- Tighten the upper fastening nuts on the engine radiator to a torque of **24 Nm**.



- Attach the two suspension sensors' connectors.
- Fit the union and screw it onto the rigid secondary air system line.

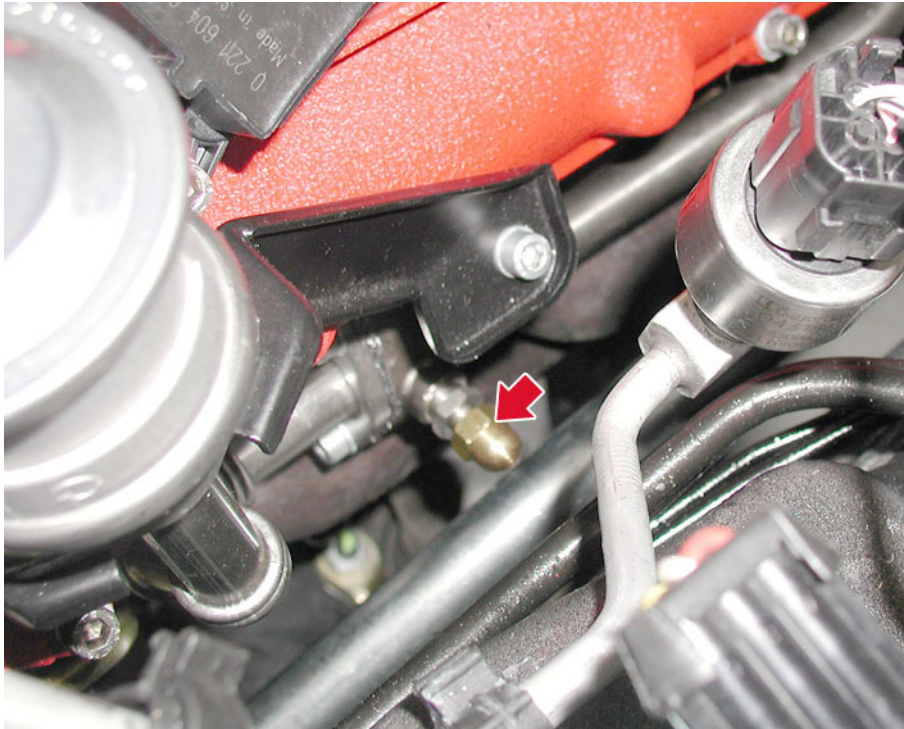

- Connect the vacuum line to the brake servo.
- Attach the electric connection and tighten the screw fastening the steering column and steering box to a torque of **25 Nm**.

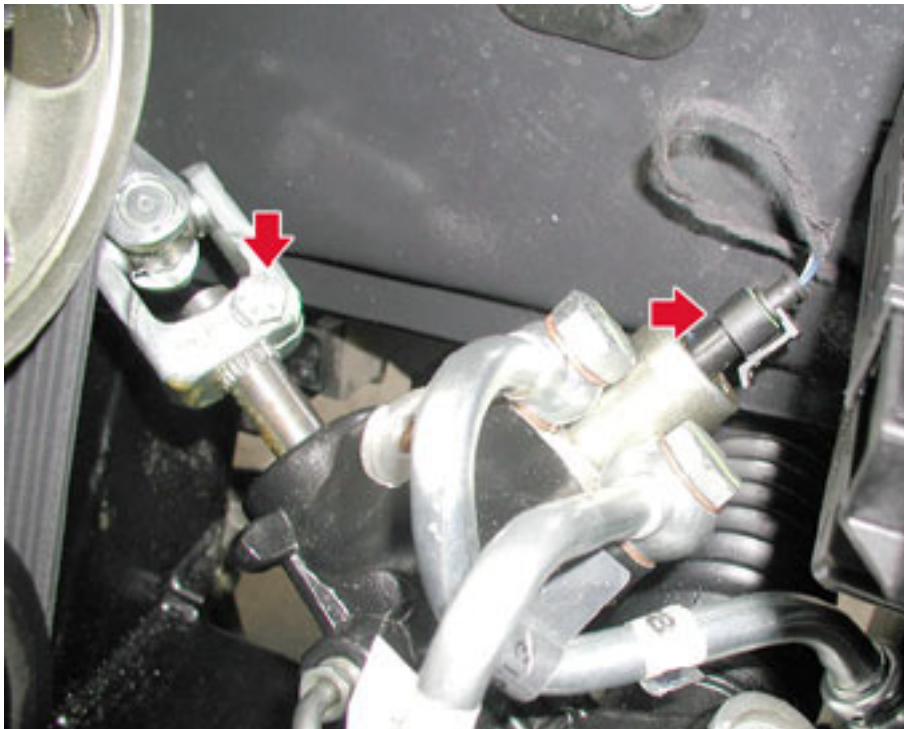

- Attach the Brake Node electric connection (ABS-ASR-MSP ECU)
- Tighten the screw fastening the hydraulic steering oil tank to the relative supporting bracket.
- Using the plastic clamp, fasten the electric ABS wiring to the hydraulic steering system line.
- Connect the air conditioning system line from the expansion valve.



- Connect the air conditioning system line from the dehydrator filter.
- Connect the water line to the heater unit.

- Tighten the starter motor cable to a torque of **9 Nm**.

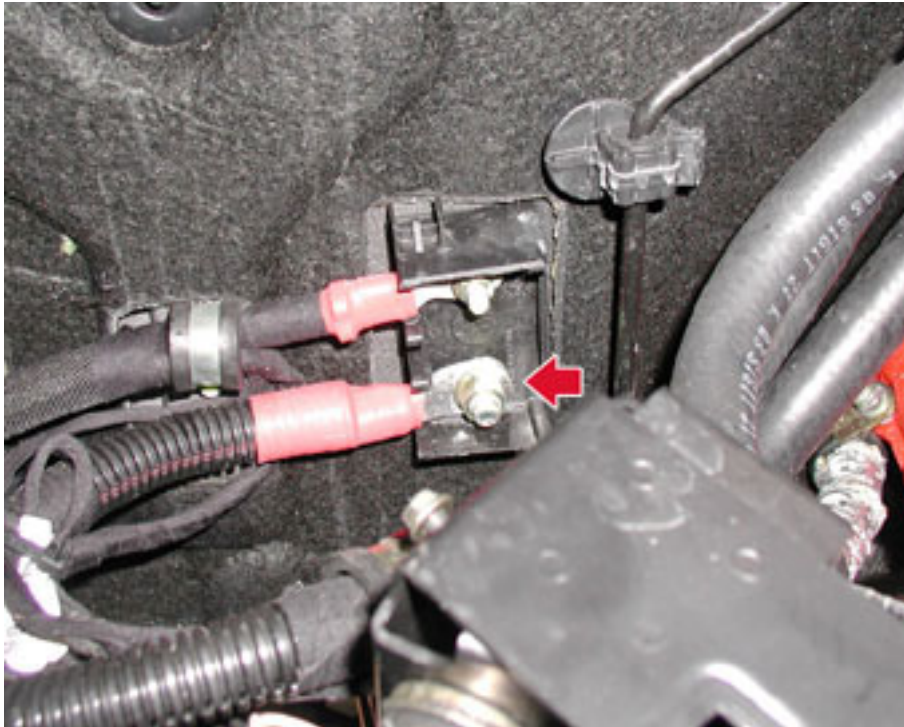

- Connect the anti-evaporation system line to the intake manifold and fasten it with plastic clamps.
- Connect the two quick couplings on the fuel lines, then connect the water line to the pump.
- Fit the dual tone horns and attach the electric connection.
- Tighten the fastening screws on the dual tone horns.
- Fit the radiator air duct and tighten all the fastening screws.
- Fit the front grille.

- Fit the dome bar in its seat inside the engine compartment and tighten the fastening screws to a torque of 49 Nm.

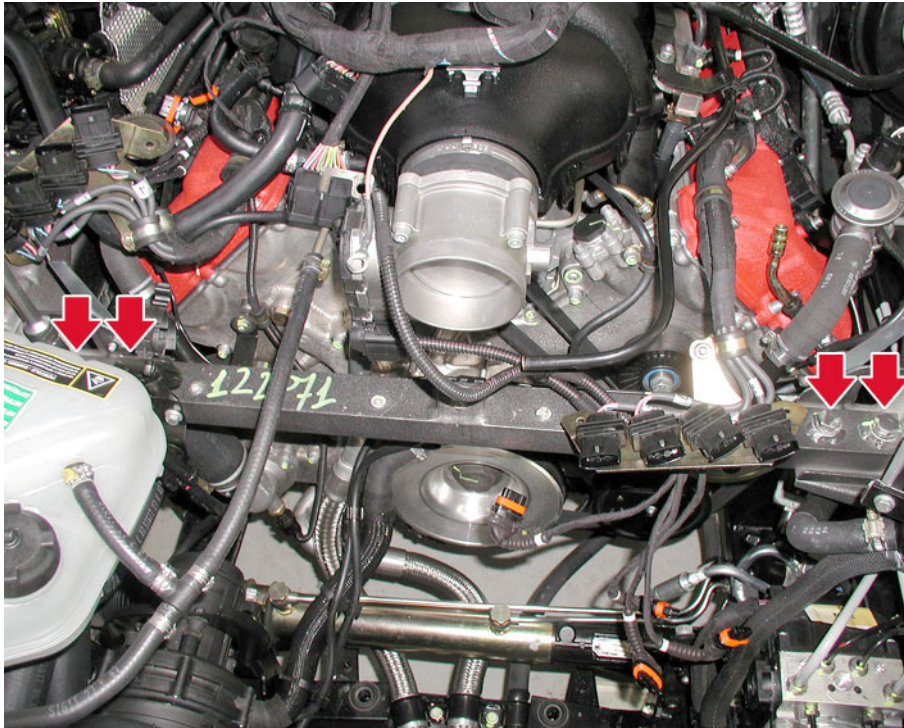

- Attach the electric connection on the additional air pump, and fasten it to the dome bar with the fastening screws on the bracket.
- Attach the connections on the ignition coils and tighten the fastening screws on the brackets fastening the connectors.
- Connect the three oil vapour lines to the engine oil tank.
- Screw up the fastening screw on the engine coolant tank.
- Fit the intake manifold and air flow meter joining sleeve.

- Connect the line to the intake manifold.



- Fit the air filter housing and tighten the fastening screw to the dome bar.



- Fit the new air filter and the relative cover on the filter housing and fasten it with the relative clips.



- Fit the two cold air intake lines.



- Fit the air flow meter and fasten it using a new clamp.



- Detach the electric connection on the air flow meter and release the two clips from the air filter housing.



- Tighten the fastening screw on the windscreen washer fluid tank.

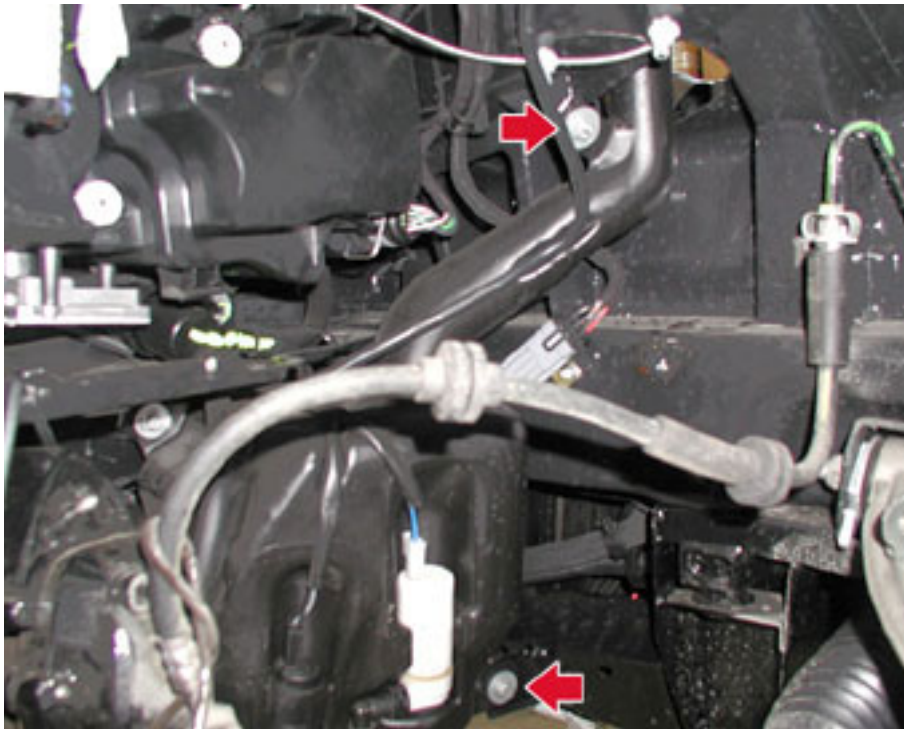

- Position the brake calipers on the disk and tighten the screws fastening the front brake calipers to the front pillar to a torque of **145Nm**.



- Connect the earth cable from the front right- and left-hand brake calipers.
- Attach the electric connection on the headlight adjustment potentiometer, on both sides of the vehicle.
- Tighten the bolt fastening the shock absorber to the lower wishbone (lever) to a torque of **78 Nm**.



- Attach the electric connection on the brake pad wear sensor (this sensor is only found on the left-hand side of the vehicle)

- Tighten the screws fastening the shock absorber to the dome to a torque of **33.6 Nm** and attach the ABS and acceleration sensors' electric connections.

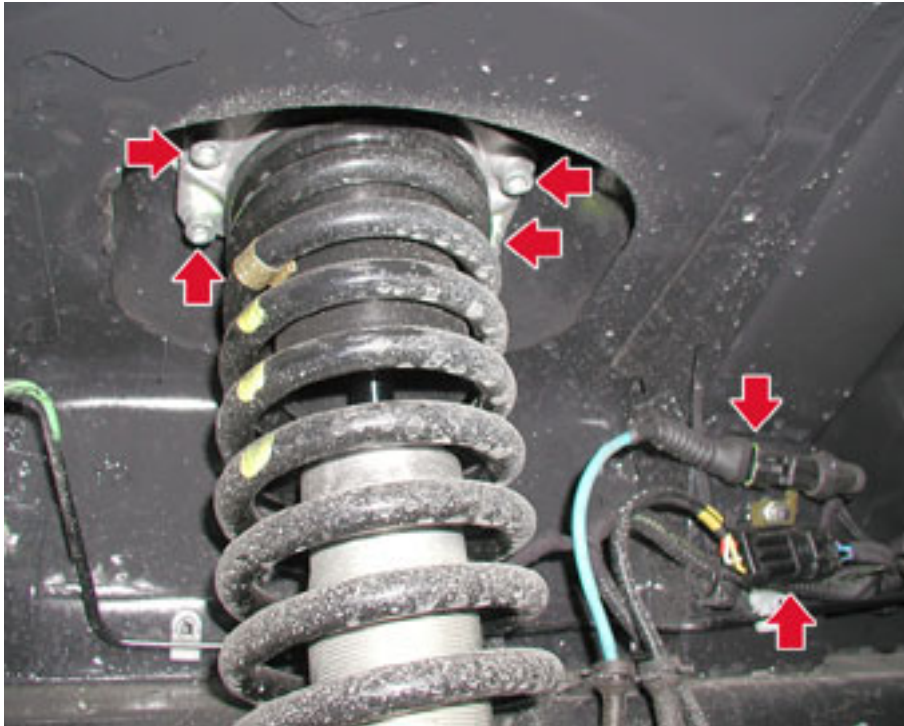

- Fit the reinforcement bracket on the bumper (on both sides).
- Fit both front wheelhouses.

Removing-refitting the front wheelhouse

- Fit both front wheels.

Replacing the wheels

- Fit the transmission shaft.

Removing-refitting the transmission shaft

- Fit the gearbox.

Removing-refitting the gearbox

- Fit the exhaust tailpipes.

Removing-refitting the tailpipe

- Remove the vehicle from the hoist.

- Working from the engine compartment towards the passenger compartment, bring the engine wiring through to the passenger compartment.

N.B.

- Fit the wiring carefully, taking care not to damage the electric connections or cut the wiring on the sharp parts of the sheet.



- Connect the two electric connections to the engine control node.



- Pull the wiring so it is laid out correctly and connect the earth cable, then attach the two electric connections.

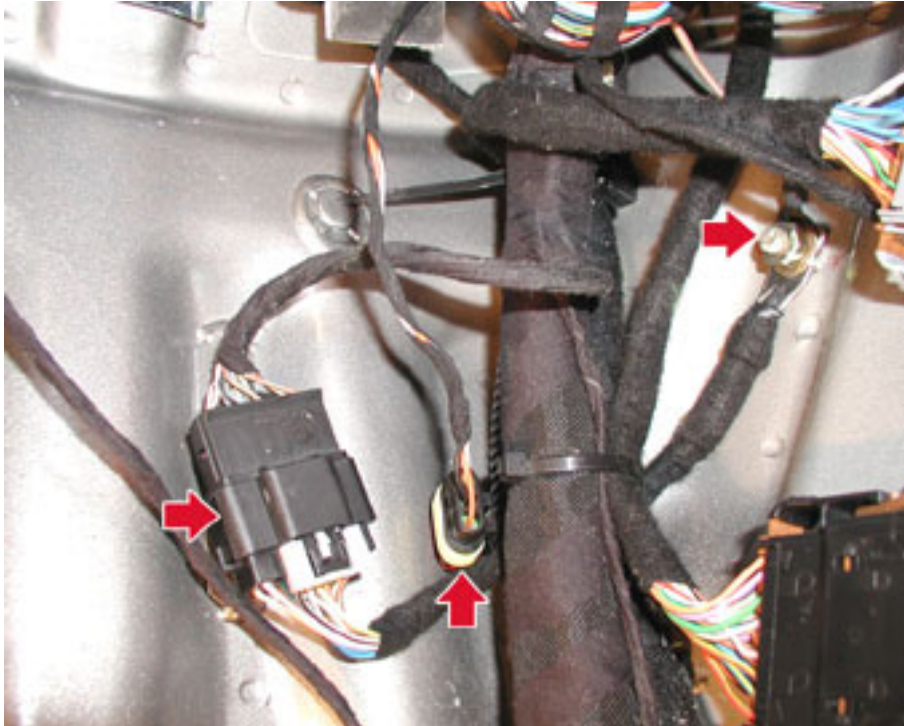

- Attach the electric connection located in the engine control node area and fasten the cable with the relative clamps.



- Fasten the engine control node.



- Fit the engine node protective bracket and tighten the two screws and the two fastening nuts.

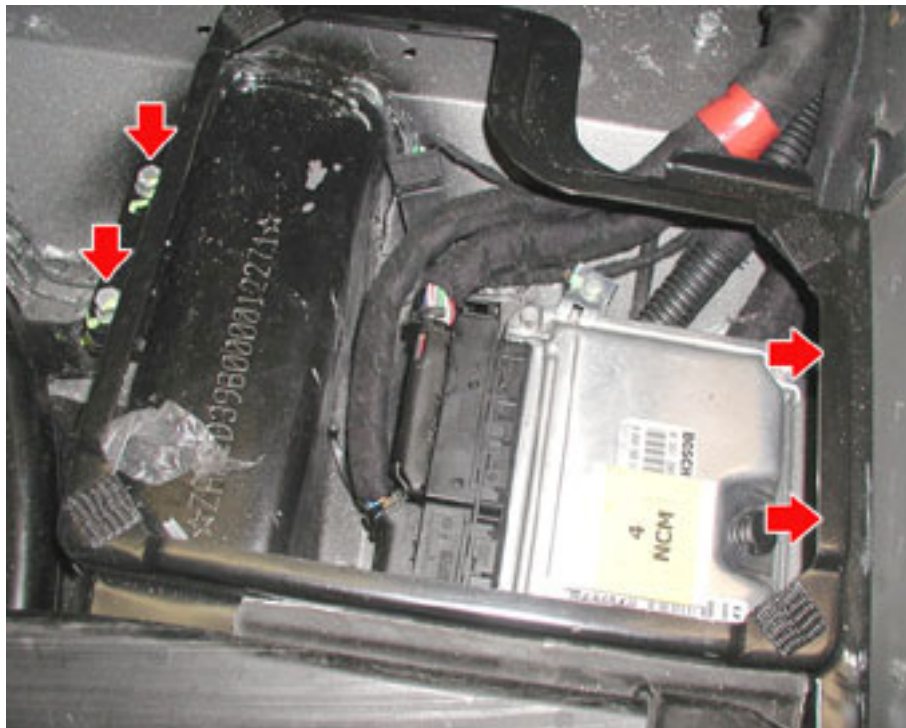

- Attach the two electric connections fastened to the mudguard and the electric connection on the fuel vapour solenoid valve.



- Fit the Bass Box proceeding as outlined for its removal but in reverse order.
- Fit the service pan and the windscreen wiper motor assembly, proceeding as outlined for their removal but in reverse order.

- Connect the equipment used to fill the R134a fluid and run a vacuum cycle to remove all R134a residues or air that has entered. Upon completion of the vacuum cycle, proceed by filling the air conditioning system.



- Connect the battery's negative terminal.
- Open the engine coolant tank cap and pour in the fluid until it reaches the **MAX** notch marked on the tank.
- Working from inside the vehicle, set the maximum temperature (+32°C) for the air conditioning/heating system manually, from both the driver's and passenger control panels.

N.B.

This operation allows the engine coolant to flow in and out the heating/air conditioning system.



- Fill the engine oil tank.



- Start the engine, keeping it idling.
- Wait until the electric fans start up at least once (engine temperature approximately 90°C) and the air that comes out the vents in the passenger compartment is warm.
- During this stage, the level of the coolant contained in the tank could drop below the **MIN** notch, so top it up and keep it level with the **MAX** notch.
- If you are unable to release all the air in the system, open the two breather caps positioned on the two cylinder heads (figure below).

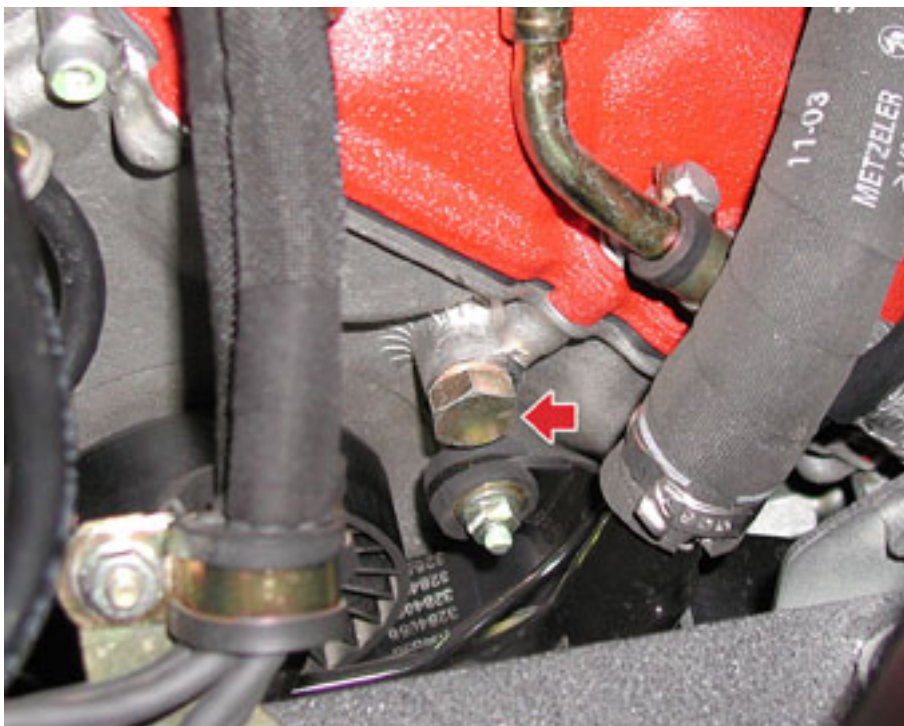



- Stop the engine.
- Check the engine oil level, then top it up to the **MAX** notch marked on the dipstick.
- Check that the engine coolant is level with the **MAX** notch.
- Allow the engine to cool.
- Pour a suitable amount of oil into the hydraulic steering oil tank, until it reaches the **MAX** notch marked on the tank cap dipstick.
- The system is self-draining. Draining is carried out by turning the steering wheel as far as possible to the left and to the right several times with the engine running and the vehicle stationary.
- Check the oil level once again after bleeding.
- Connect the SD3 **95970312** and bleed the clutch.

Bleeding the clutch

- Fit the trim panels on the engine compartment.
- After connecting the battery's negative terminal the following self-learning operations must be carried out to ensure that certain connected devices acknowledge the system again:
- Refer to section:

Component self-learning in the event of battery disconnection

- Check the front and rear wheel alignment.

Front wheels

Rear wheels

CIRCUIT FILLING AND LEVEL CHECKS

Circuit filling and check point locations

- Below is a list of the positions of the tanks and dipsticks for checking the system fluid levels and for topping-ups (if necessary).



- 1) Dipstick for engine oil level checks
- 2) Engine coolant tank
- 3) Power steering fluid tank
- 4) Windscreen washer fluid tank
- 5) Brake system fluid tank

Engine lubrication circuit

CAUTION

When the engine is warm, be very careful when working inside the engine compartment: risk of burns!

Remember that when the engine is warm, the electric fan could start to move: risk of injuries!

- The level check must be performed with the vehicle on a flat surface and the engine warm and idling. The oil level must be between the **MIN** and **MAX** notches on the dipstick . The gap between **MIN** and **MAX** corresponds to about 1 litre of oil.

IMPORTANT

Do not top up with oil whose specifications differ from those of the oil already used in the engine.

CAUTION

The engine oil used and the oil filter replaced contain substances that are dangerous for the environment. You are advised to contact the Maserati Service Network for oil and filter changes since they have the right facilities for disposing of the used oils and filters, ensuring respect for the environment and observance of the regulations in force.

- If the engine oil level is close to or actually below the **MIN** reference mark, add oil through the filler cap until the **MAX** reference mark is reached. The oil level should never exceed the **MAX** reference point.

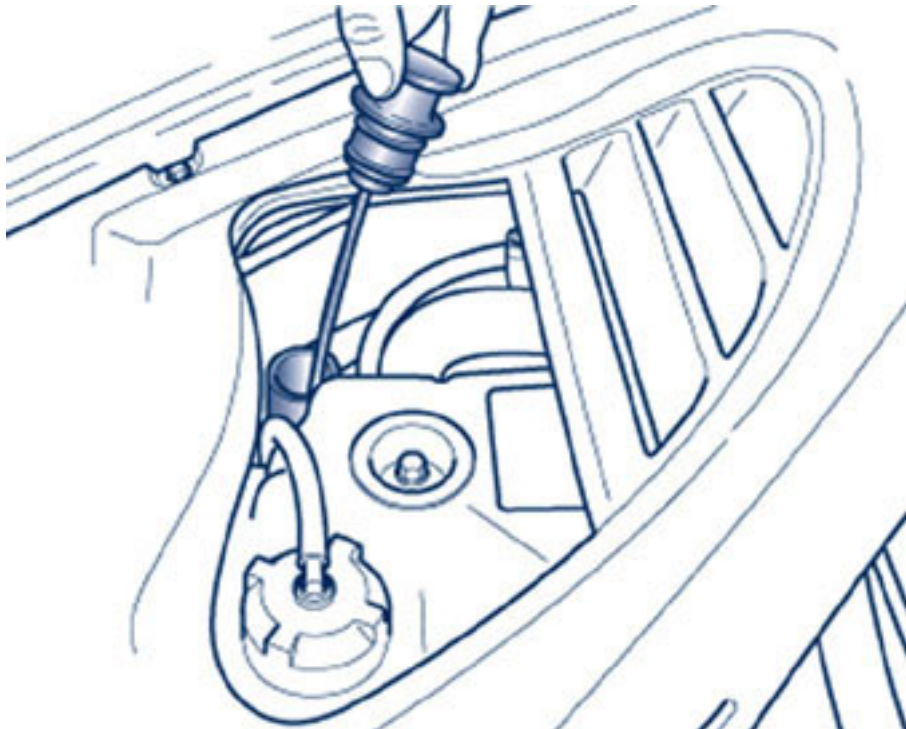

Engine coolant circuit

CAUTION

When the engine is very hot, do not remove the pan cap: risk of burns!

- The fluid level must be checked when the engine is cold, and it must fall between the **MIN** and **MAX** references marked on the pan. If the level is low, slowly pour the prescribed fluid through the filler neck on the pan until the level is close to the **MAX** reference point.

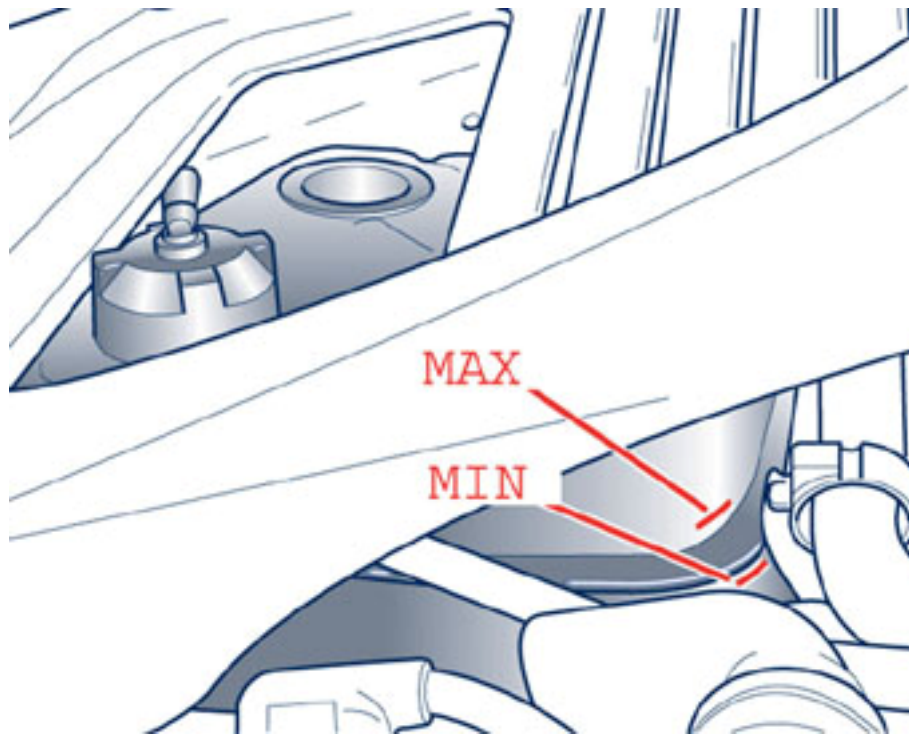

- The operation for filling the engine's water circuit must be carried out by partially unscrewing the two water outlet caps on the heads. These caps are located in the front section of the engine to permit breathing of any air contained in the top part of the engine during the filling stage.

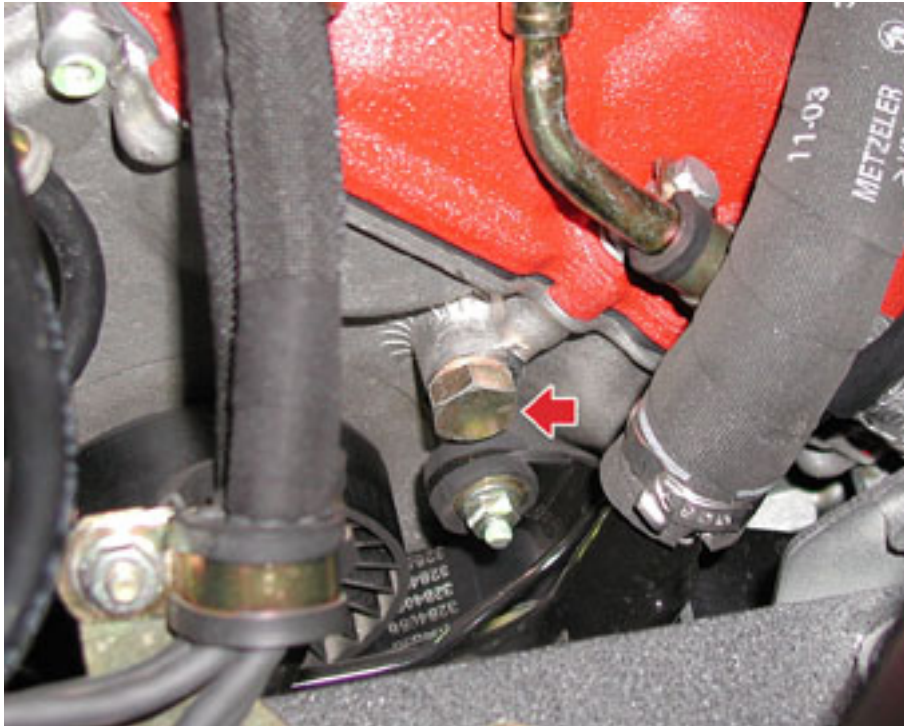

Hydraulic steering fluid circuit

IMPORTANT

Make sure that the power steering fluid does not come into contact with the engine's hot parts as it is flammable.

- With the vehicle on flat ground and the engine cold, check that the fluid level reaches the **MAX** reference point on the tank cap dipstick. To carry out the check, back off the plug, clean the dipstick, replace and tighten the cap, then remove it again and check the level.

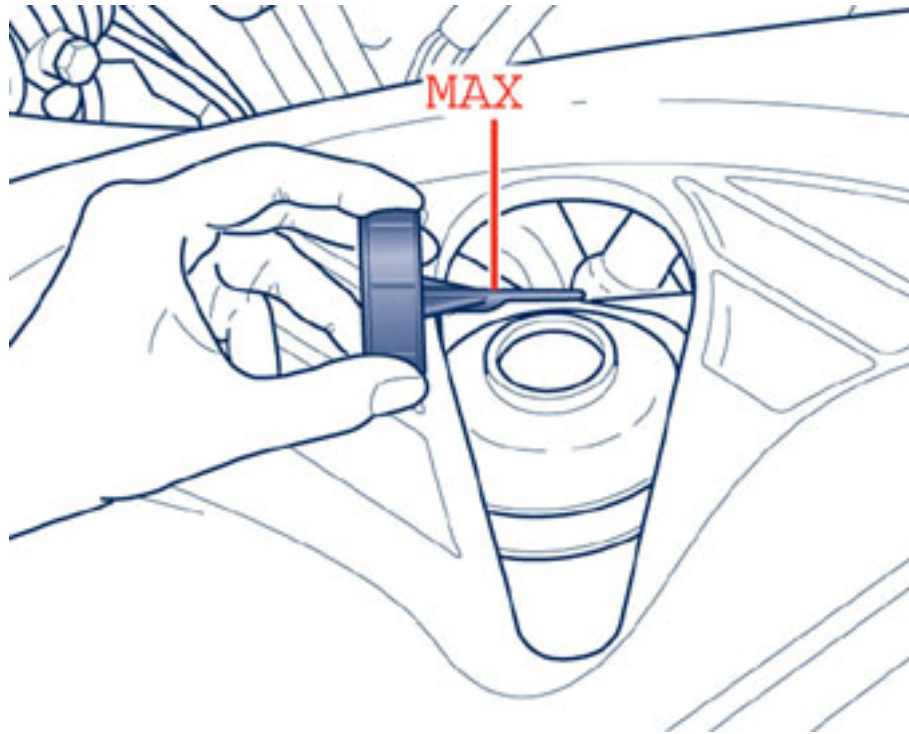

The system is self-draining. Draining is carried out by turning the steering wheel as far as possible to the left and to the right several times with the engine running and the vehicle stationary. This procedure must be carried out every time the delivery and return lines which run to the steering box are disconnected

- Check the oil level once again after draining.
- With the engine running, also check for any oil leakages from the hydraulic steering system.

Windscreen washer/headlight washer fluid circuit

- To add fluid, open the headlight and windscreen washer fluid tank cover, extract the filler neck extension and pour in the detergent and water mixture, in the proportions indicated on the bottle.

N.B.

If the temperature is below 20°C, use pure detergent fluid.



Brake circuit oil

- Check that the fluid level in the reservoir is at the maximum level (**MAX** notch). If the level drops below the minimum, with the starter key at **MAR**, the relative warning light on the instrument panel lights up.
- If fluid is needed, use only the type classified as DOT4;

IMPORTANT

The brake fluid is hygroscopic (i.e. it absorbs humidity). For this reason, if the car is used mainly in areas with a high rate of atmospheric humidity, the fluid should be changed more frequently than indicated in the Service Time Schedule.

IMPORTANT

Do not let the brake fluid, which is highly corrosive, come into contact with the paintwork. If this does occur, wash the paintwork immediately with water.

The symbol on the container identifies the synthetic type of brake fluid, distinguishing it from the mineral type. Using mineral fluids damages the special rubber linings of the brake system beyond repair.

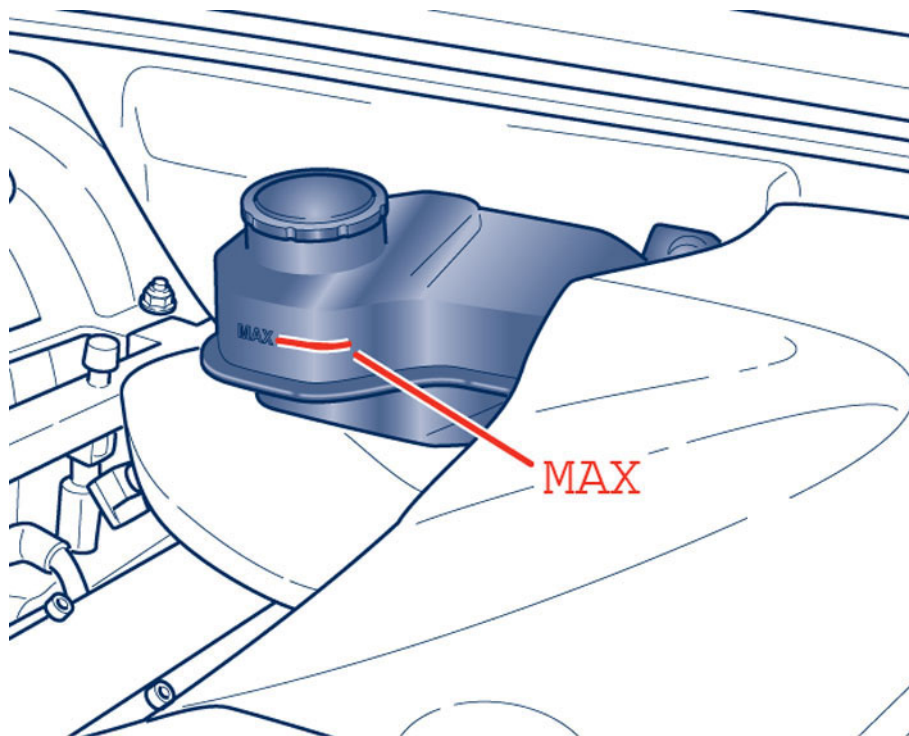

Connecting the equipment used to carry out procedures on the air-conditioning system coolant.

The system lines have two unions, one for the high and one for the low pressure, which are used for coolant-related operations such as:

- coolant absorption;
- system drainage and dehydration;
- finding leakages in the circuit;
- filling the oil for the vacuum pump;
- filling the system with coolant (R134a);

Version	Quantity
USA	-
EUROPE	1100 g +/- 25

- checking the system operation.

The operations outlined above can be carried out with different types of equipment, which can have different operating procedures; because of this, you should refer to the Owner's Manual for the machinery employed for more detailed information.

The high and low pressure unions are shown in the vehicle with the charging equipment connections.



RIGHT-HAND SIDE ENGINE MOUNT

Removal

- Place the vehicle on the hoist.
- Remove the trim panels.



- Rotate the plastic fastening screws on the engine compartment fuse box cover by 90°, then remove the cover.



- Undo the two fastening screws on the engine compartment fuse box.



- Undo the three fastening screws and remove the engine compartment fuse box mount.



- Undo the bracket screw (1) and the rigid line screws (2).

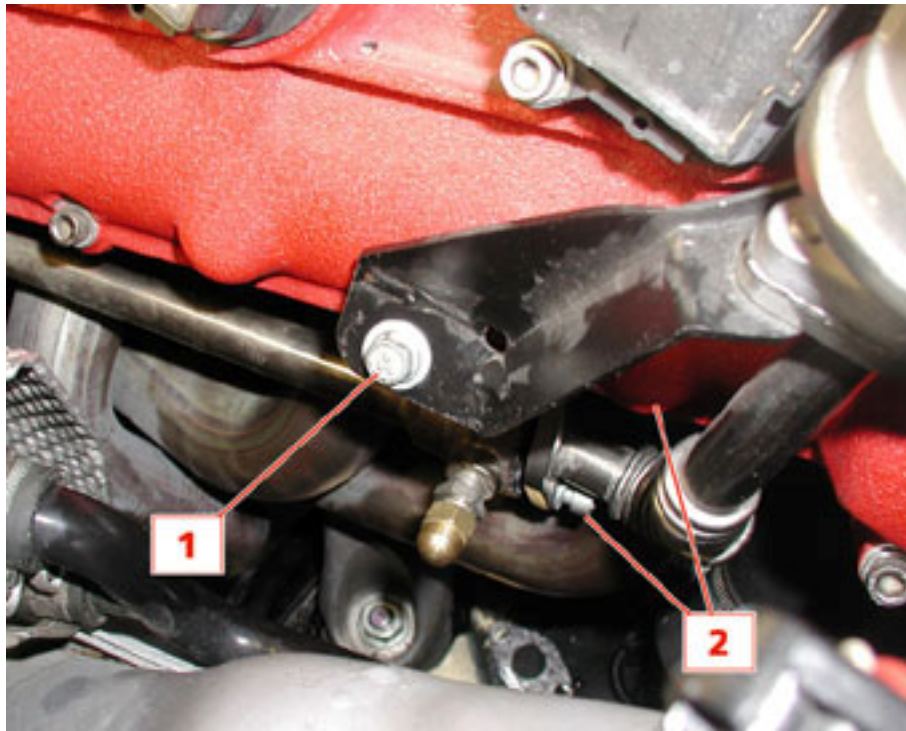

- Undo the remaining retaining screw for the pneumatic valve bracket.

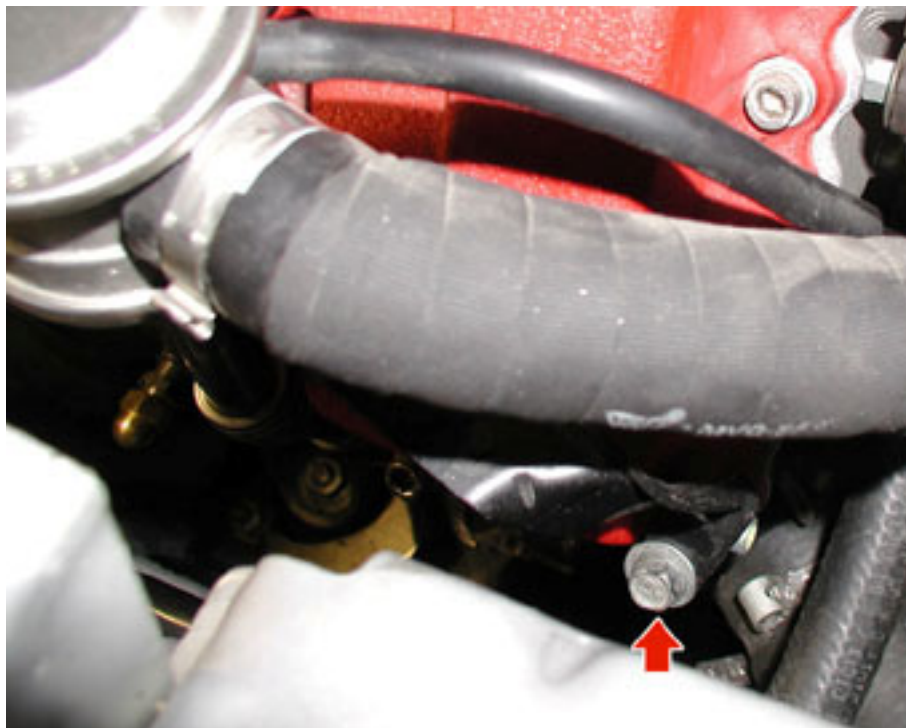

Remove the floor guard beneath the engine.

Engine floor guard

- Place a pan under the engine oil tank cap to collect the oil.
- Unscrew the cap **(1)** and wait until all the engine oil has drained out.
- When the oil has drained out, screw the oil tank cap back on.



- Undo the retaining screws of the engine oil filter heat shield.

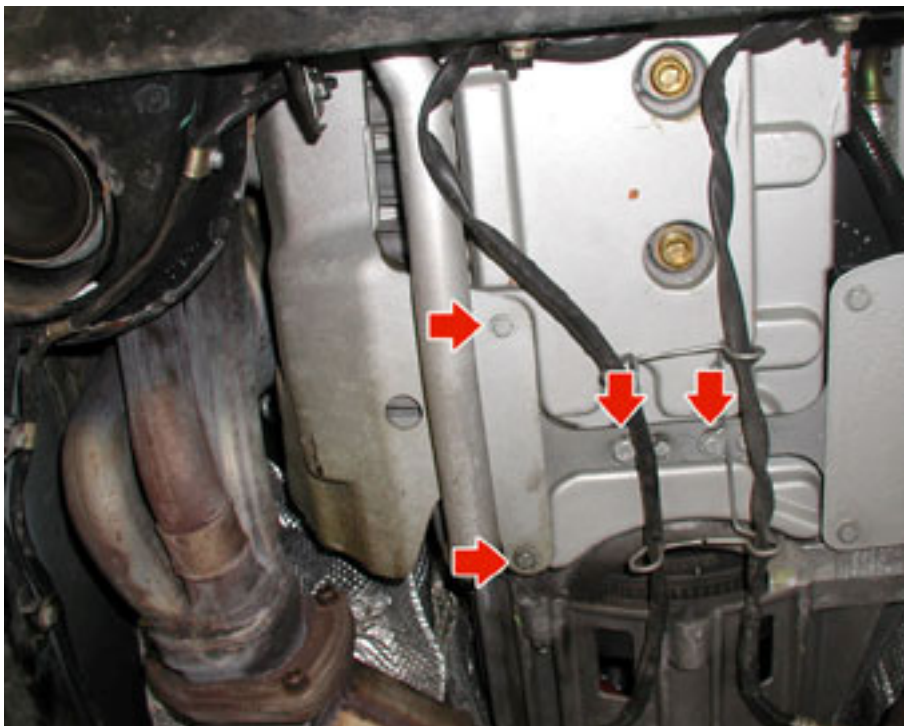

- Undo the screws that secure the rigid engine oil line from the pump.

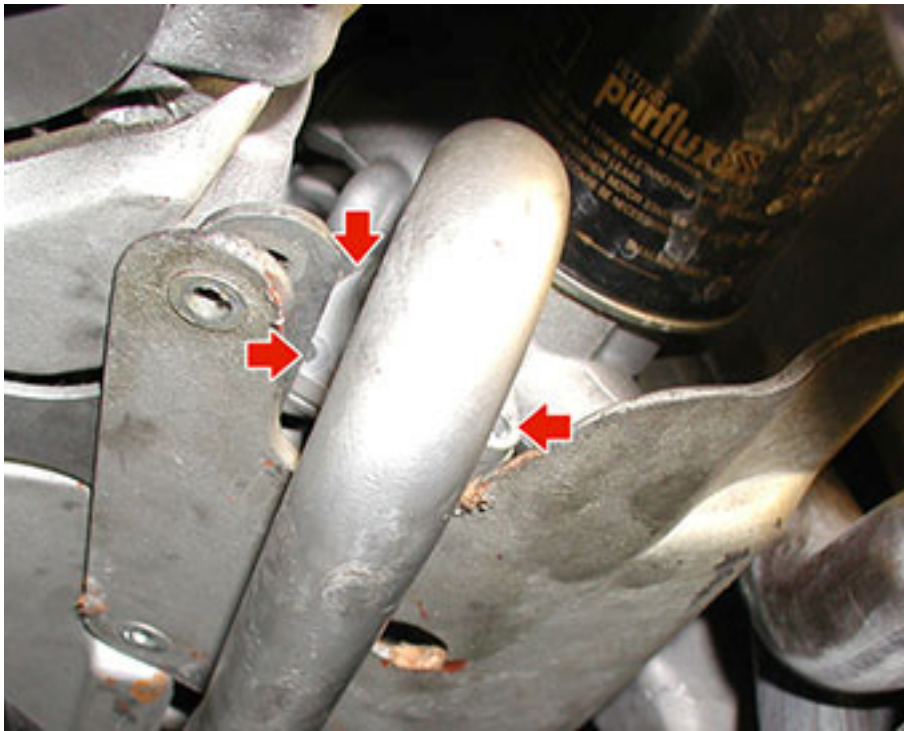

- Using a generic tool, unscrew and remove the oil filter.



- Undo the remaining two upper screws and remove the heat shield of the engine oil filter.



- Undo the screws securing the catalytic converter to the exhaust manifold.

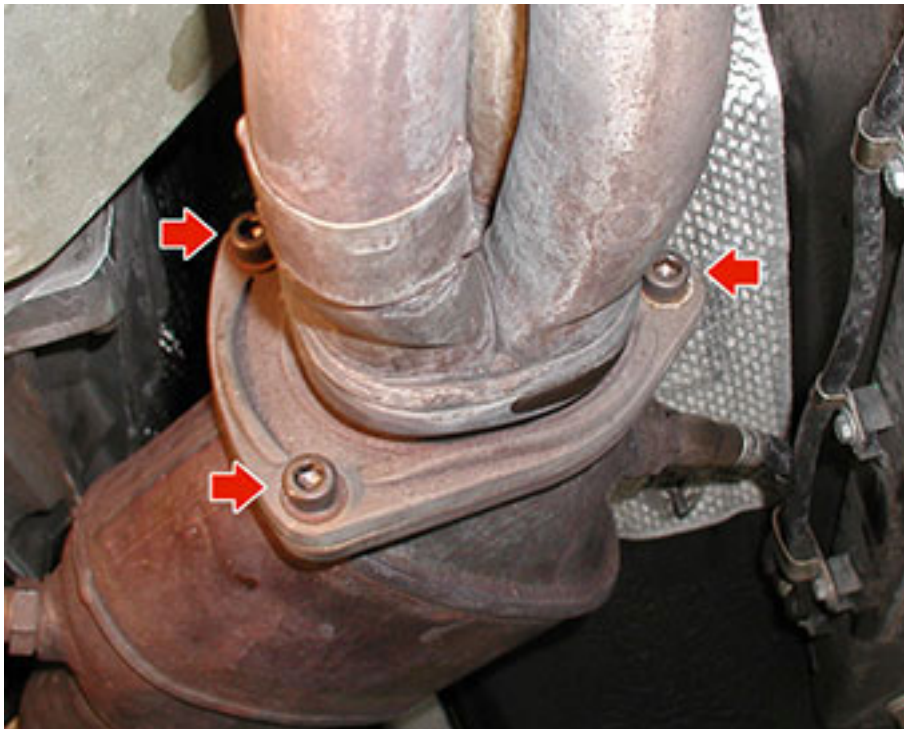

- Unscrew the nuts fastening the exhaust manifold to the cylinder head.
- Remove the RH exhaust manifold by slipping it off the stud bolts.

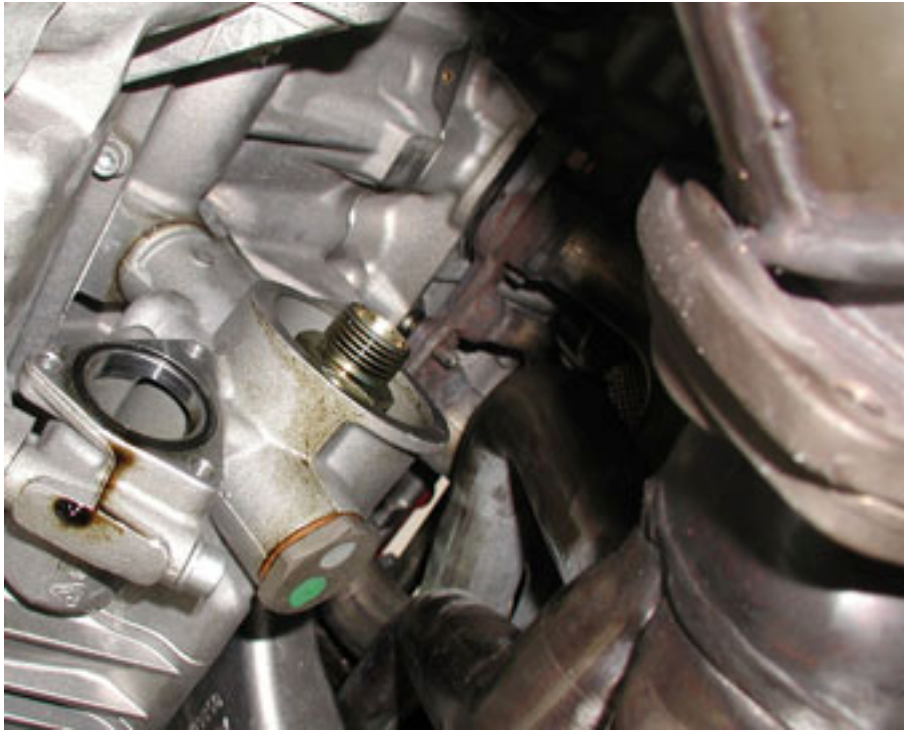

- View of the flange which attaches the exhaust manifold to the cylinder head.



- Unscrew the nut that secures the RH engine mount to the relevant dowel block.



- Place a hydraulic supporting and lifting device (1) under the engine so as to work in safety.



- Undo the screws that secure the RH engine mount to the crankcase.



- The retaining screws (1) are easily accessible, while the retaining screw (2) needs to be accessed with a special wrench.

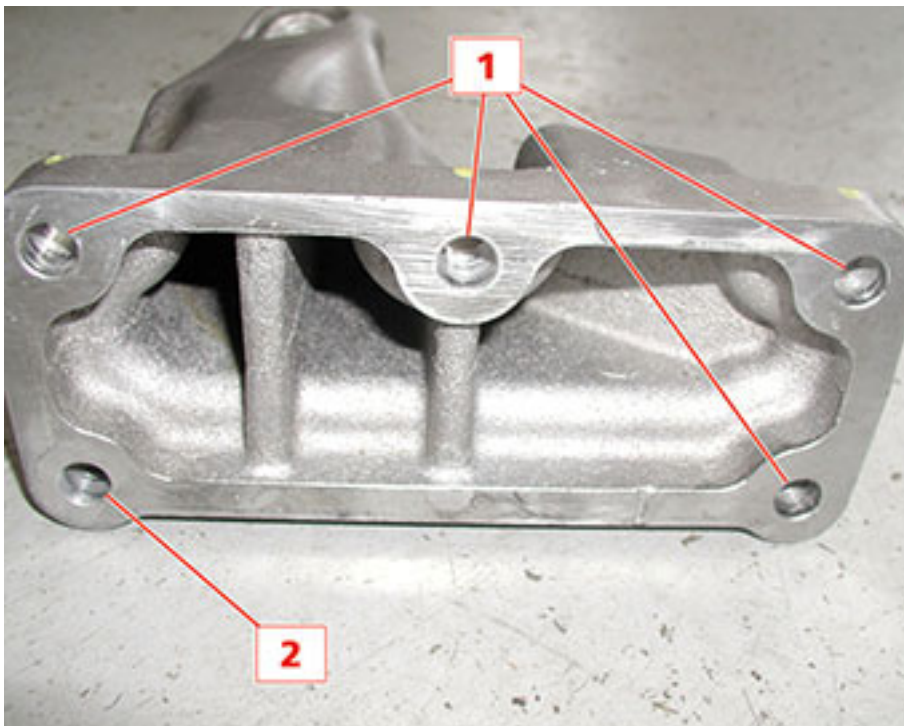

- Remove the RH engine mount.



Refitting

- Check that the component is intact.
- Fit the engine mount in its seat and tighten the crankcase retaining screws to a torque of **45 Nm**.
- Tighten the nut fastening the mount to the dowel screw to a torque of **120 Nm**.



- Remove the hydraulic supporting and lifting device (1) positioned previously from under the engine.



- Fit the new gasket, fit the exhaust manifold complete and tighten the fastening nuts to a torque of **25 Nm**.

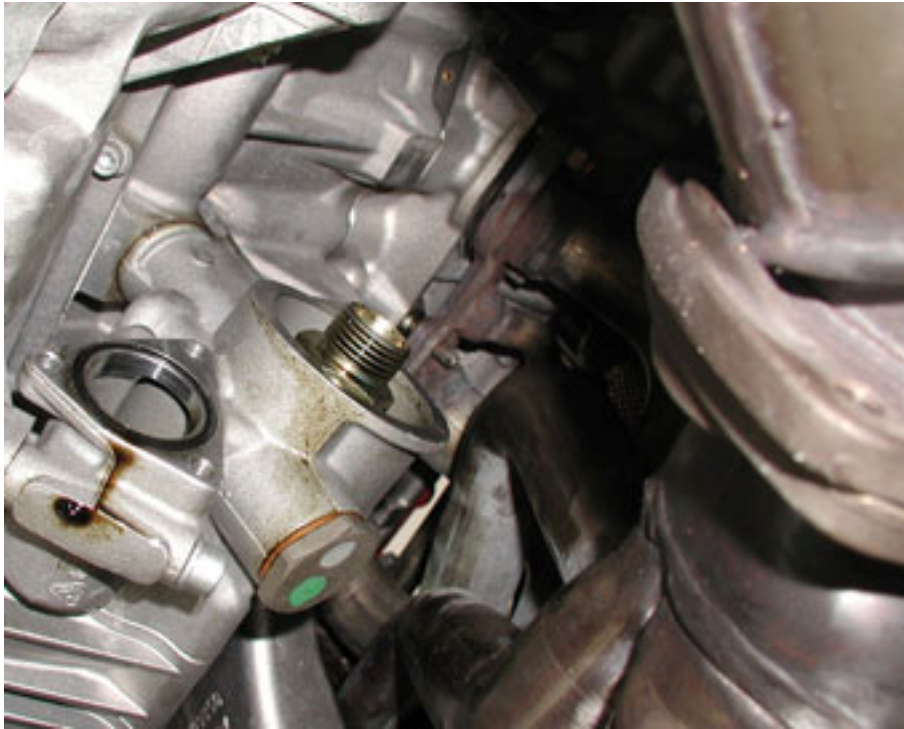

- Tighten the screws fastening the exhaust manifold to the catalytic converter to a torque of **25 Nm**.

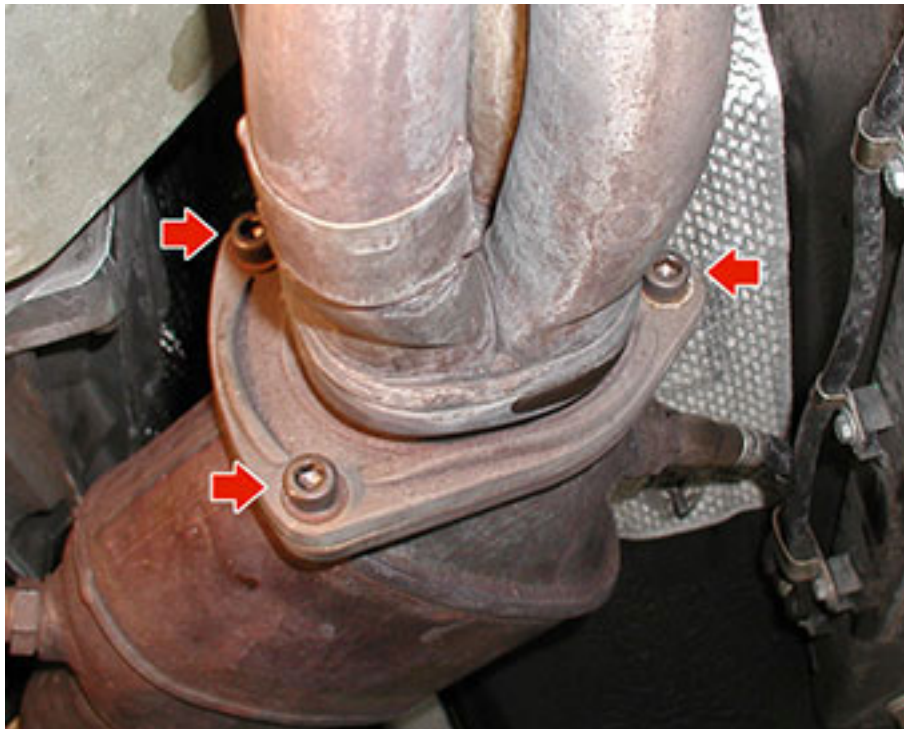

- Fit the engine oil filter heat shield and tighten the upper retaining screws.



- Lubricate the oil filter surfaces using engine oil
- Fit the new oil filter, screwing it on manually.



- Tighten the screws that secure the rigid engine oil line from the pump.

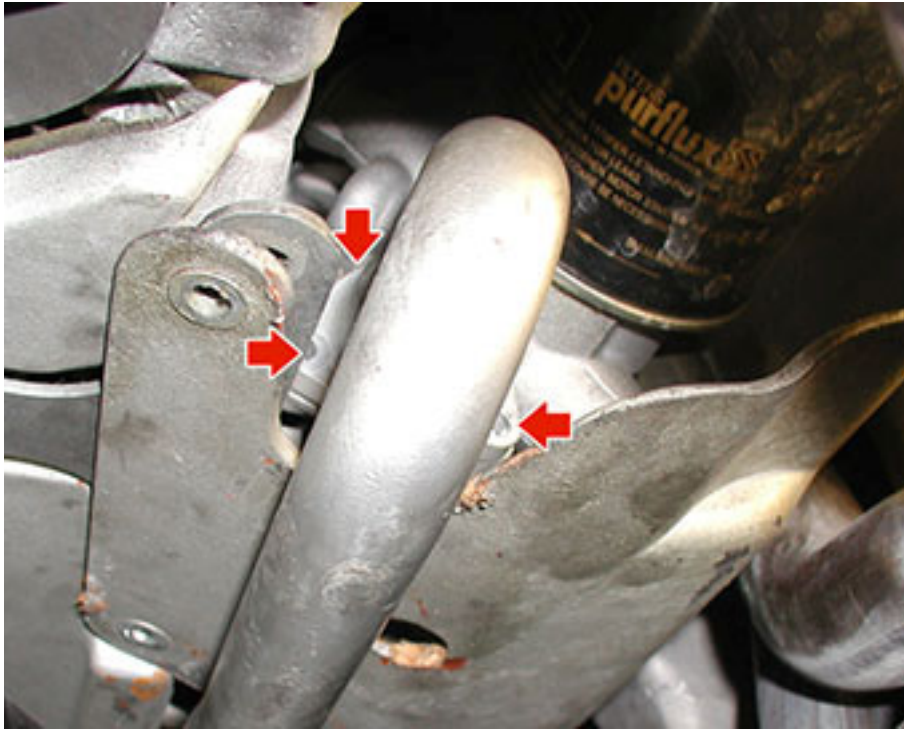

- Tighten the retaining screws of the engine oil filter heat shield.

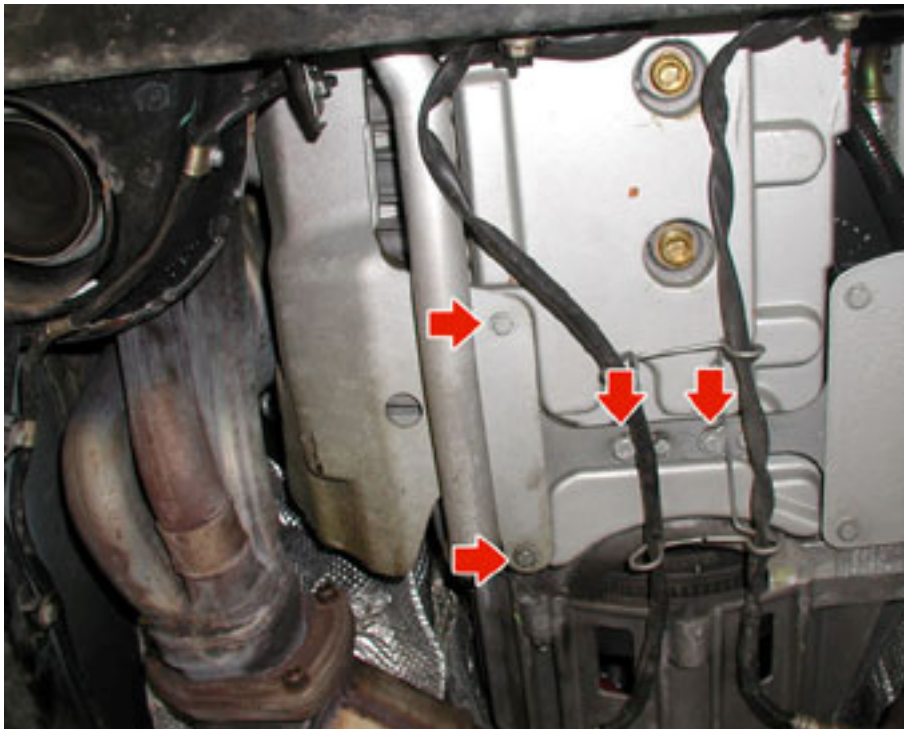

- Secure the pneumatic valve tightening the bracket screws.
- Fit the engine compartment fuse box mount.
- Fit the engine compartment fuse box cover.
- Secure the engine compartment fuse box cover.
- Connect the negative terminal of the battery.
- Fill the engine oil tank.



- Start the engine, keeping it idling.
 - Wait for the electric fans to start up at least once (engine temperature approximately 90°C).
 - Stop the engine.
 - Check the engine oil level, then top it up to the **MAX** notch marked on the dipstick.
 - Fit the trim panels on the engine compartment.
- After connecting the battery's negative terminal, the following self-learning operations must be carried out to ensure that certain connected devices acknowledge the system again:
 - Refer to section:
 - Component self-learning in the event of battery disconnection*
 - Fit the engine floor guard.
 - Engine floor guard*

ELASTIC DOWEL BLOCK ON THE RIGHT-HAND SIDE OF THE ENGINE

Removal

- Place the vehicle on the hoist.
- Remove the trim panels.



- Rotate the plastic fastening screws on the engine compartment fuse box cover by 90°, then remove the cover.



- Undo the two fastening screws on the engine compartment fuse box.



- Undo the three fastening screws and remove the engine compartment fuse box mount.



- Undo the bracket screw (1) and the rigid line screws (2).

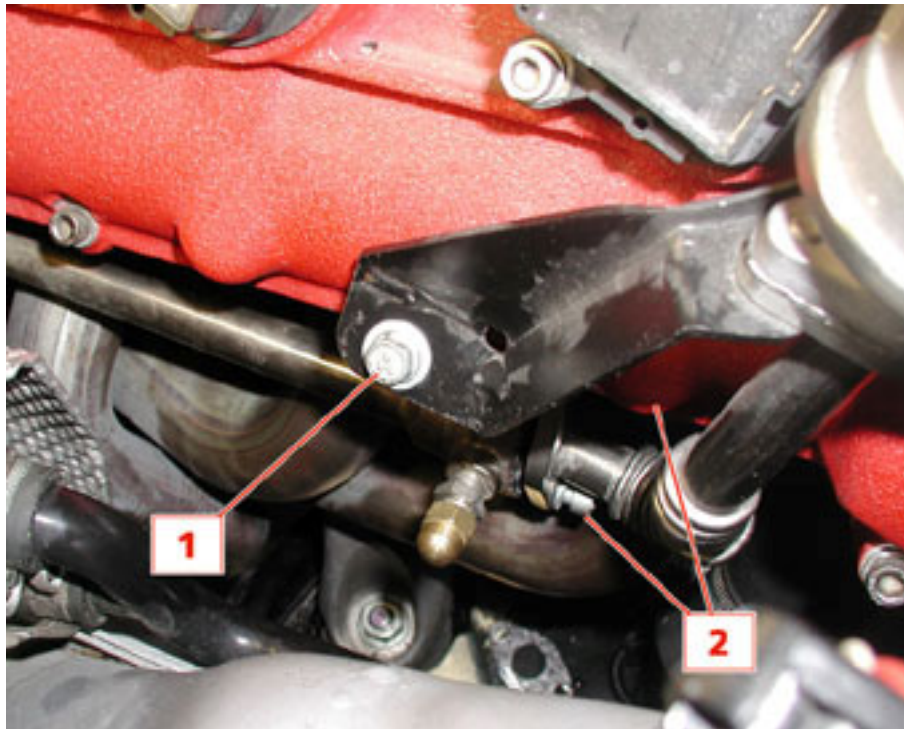

- Undo the remaining retaining screw for the pneumatic valve bracket.



- Remove the floor guard beneath the engine.

Engine floor guard

- Place a pan under the engine oil tank cap to collect the oil.
- Unscrew the cap **(1)** and wait until all the engine oil has drained out.
- When the oil has drained out, screw the oil tank cap back on.



- Undo the retaining screws of the engine oil filter heat shield.

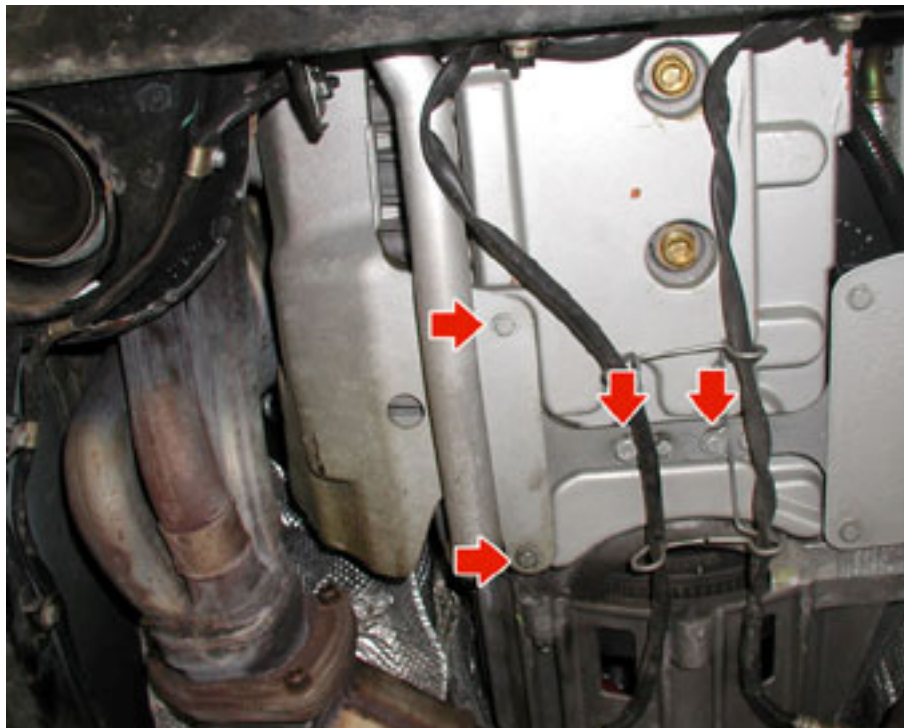

- Undo the screws that secure the rigid engine oil line from the pump.

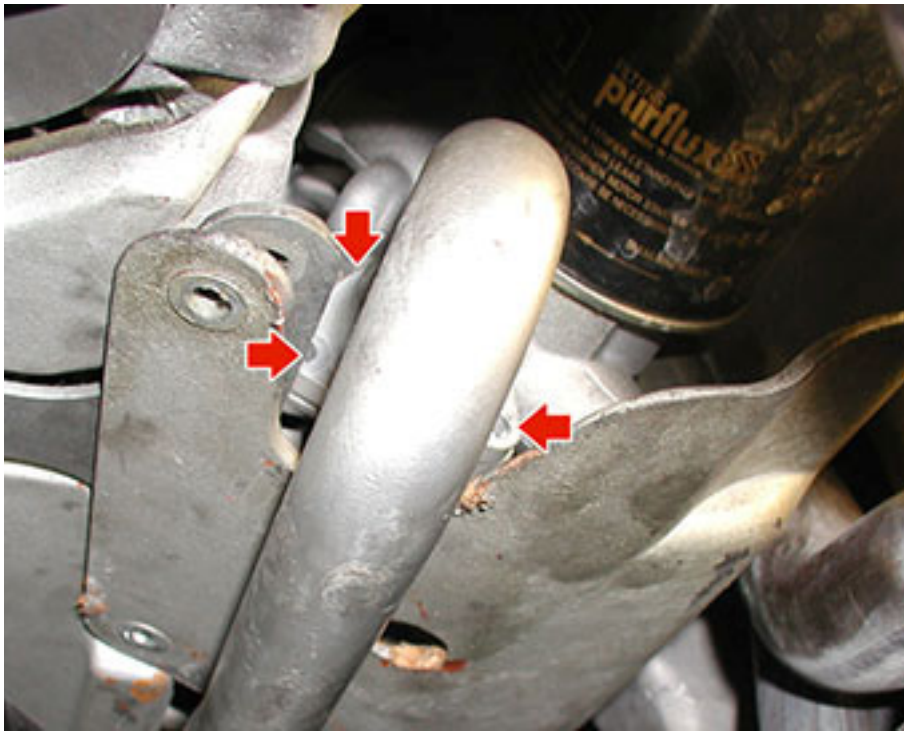

- Using a generic tool, unscrew and remove the oil filter.



- Undo the remaining two upper screws and remove the heat shield of the engine oil filter.



- Undo the screws securing the catalytic converter to the exhaust manifold.

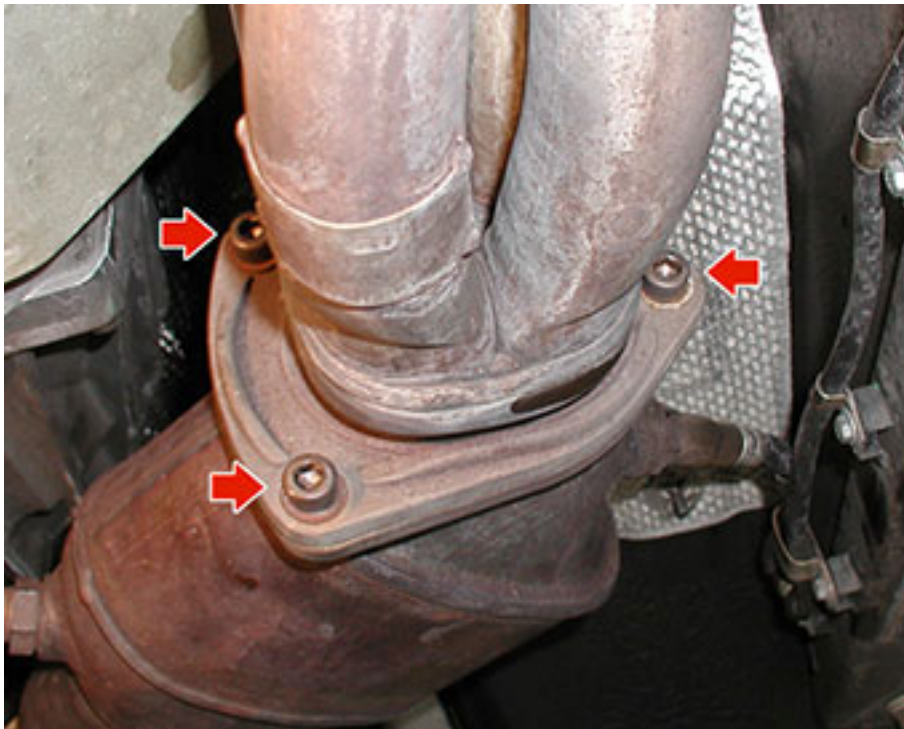

- Unscrew the nuts fastening the exhaust manifold to the cylinder head.
- Remove the RH exhaust manifold by slipping it off the stud bolts.



- View of the flange which attaches the exhaust manifold to the cylinder head.



- Unscrew the nut that secures the RH engine mount to the relevant dowel block.



- Place a hydraulic supporting and lifting device **(1)** under the engine so as to work in safety.



- Undo the retaining screws that secure the RH engine mount **(1)** (see next figure) to the crankcase, except for the retaining screw **(2)** (see next figure) which must only be loosened.



- The retaining screws **(1)** are easily accessible, while the retaining screw **(2)** needs to be accessed with a special wrench.

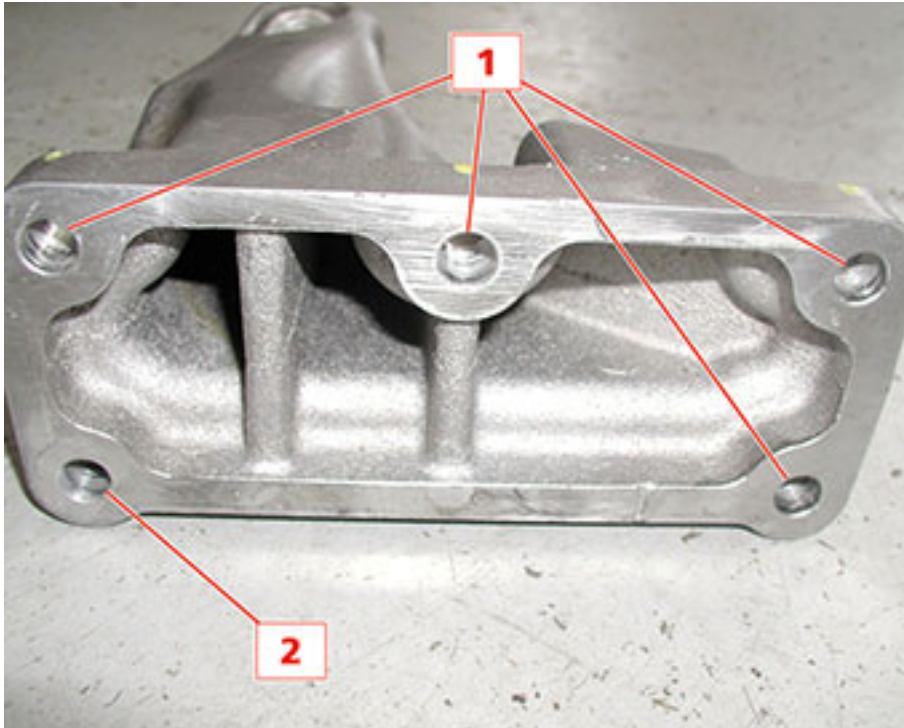

- Turn the RH engine mount in such a way that the fittings of the elastic dowel block can easily be accessed.



- Unscrew the nuts that secure the elastic dowel block to the engine frame.



- Lift and remove the elastic dowel block from its seat on the engine frame.



Refitting

- Check that the component is intact.
- Fit the elastic dowel block and tighten the two nuts that secure the elastic dowel block to the engine frame to a torque of **50 Nm**.

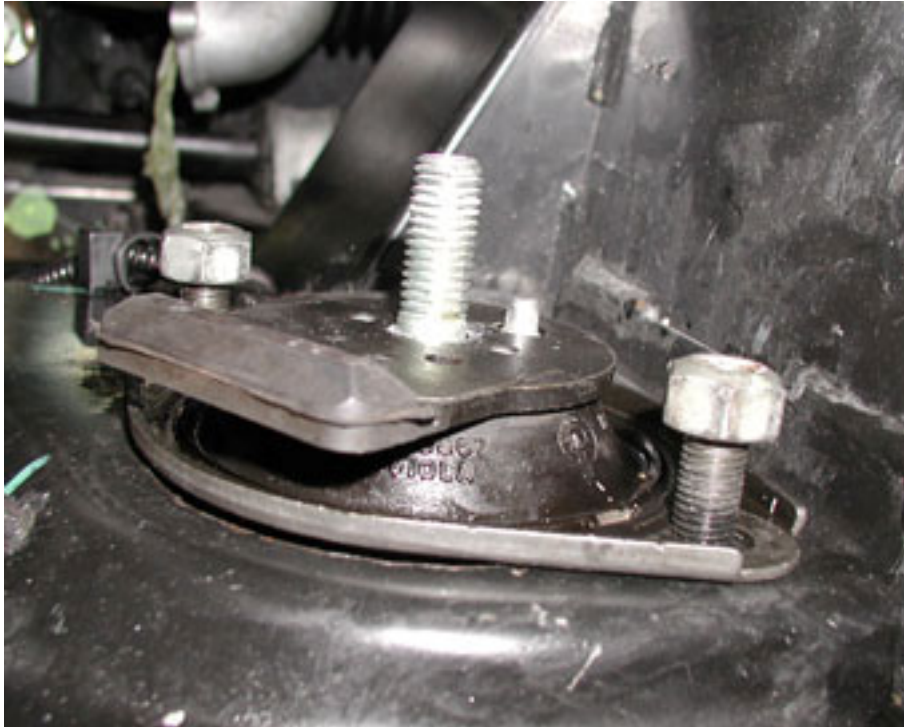

- When refitting the elastic dowel block, be careful with its orientation on the frame.
- Fit the elastic dowel block in such a way that the pin **(1)** can be coupled to the hole **(2)** on the engine mount.

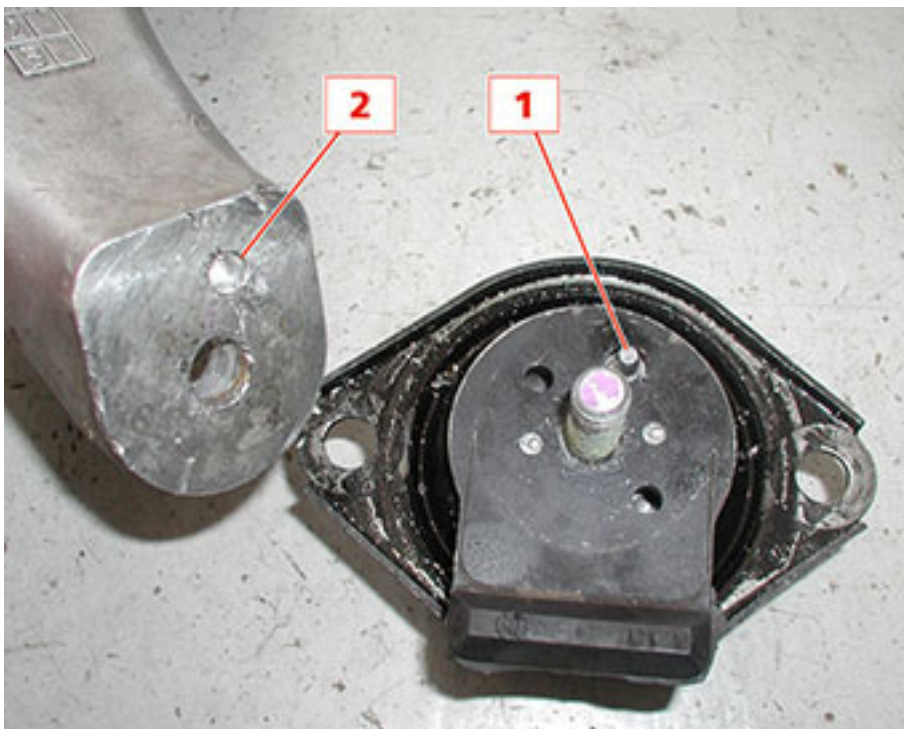

- Fit the engine mount in its seat and tighten the crankcase retaining screws to a torque of **45 Nm**.
- Tighten the nut fastening the mount to the dowel block to a torque of **120 Nm**.



- Remove the hydraulic supporting and lifting device (1) positioned previously from under the engine.



- Fit the new gasket, fit the exhaust manifold complete and tighten the fastening nuts to a torque of **25 Nm**.

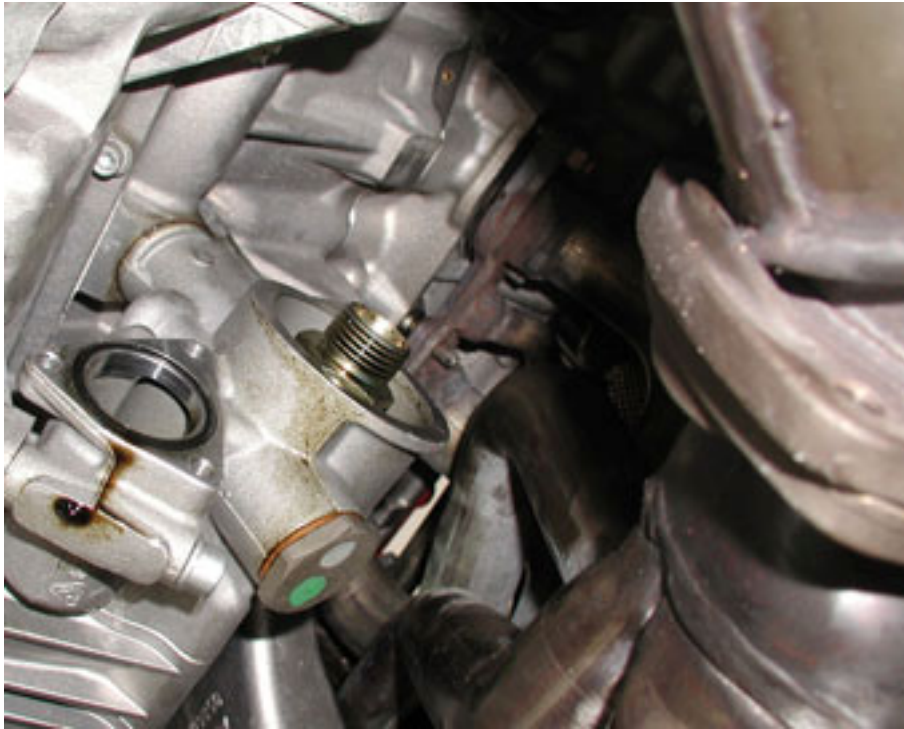

- Tighten the screws fastening the exhaust manifold to the catalytic converter to a torque of **25 Nm**.

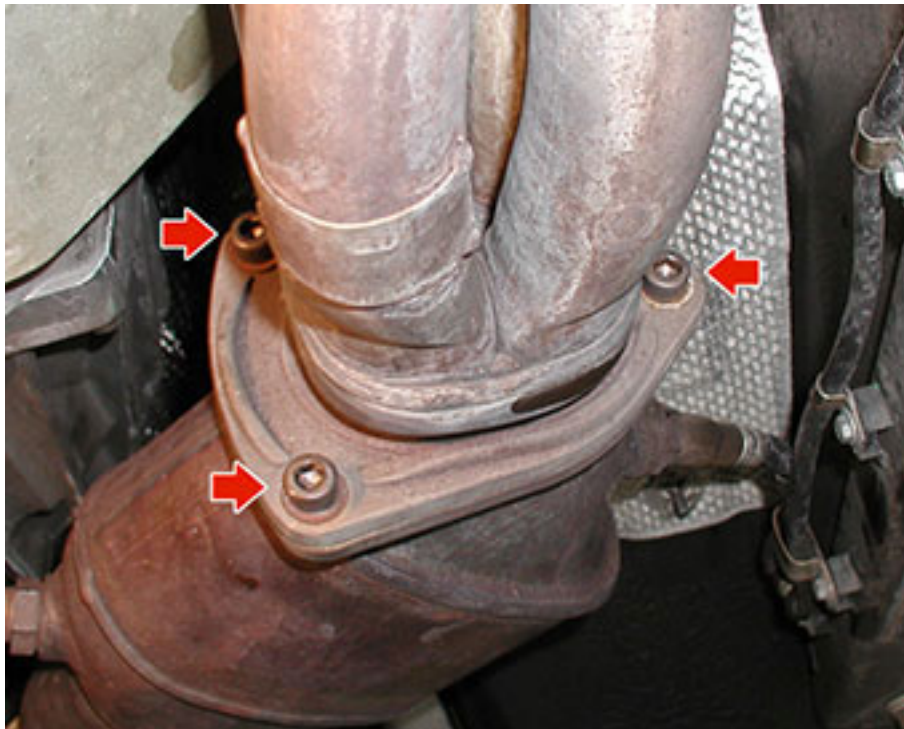

- Fit the engine oil filter heat shield and tighten the upper retaining screws.



- Lubricate the oil filter surfaces using engine oil
- Fit the new oil filter, screwing it on manually.



- Tighten the screws that secure the rigid engine oil line from the pump.

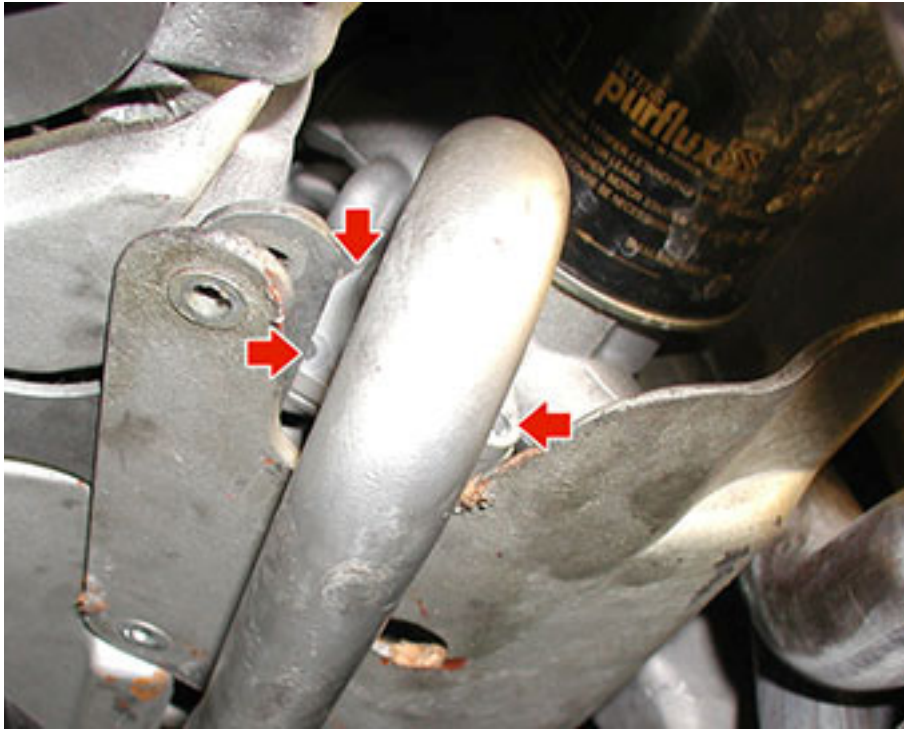

- Tighten the retaining screws of the engine oil filter heat shield.

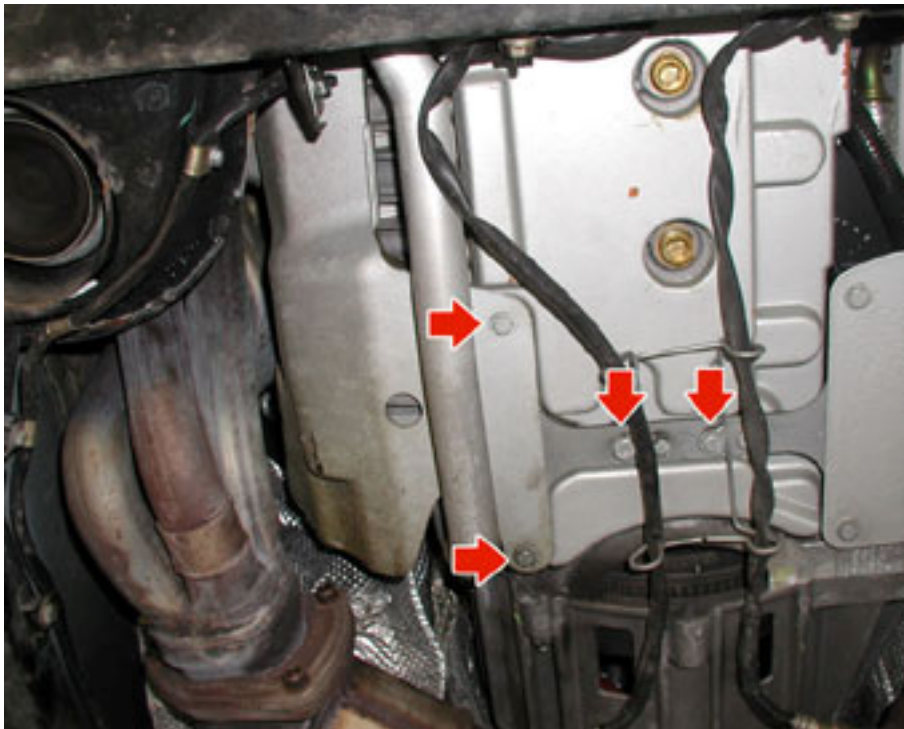

- Secure the pneumatic valve tightening the bracket screws.
- Fit the engine compartment fuse box mount.
- Fit the engine compartment fuse box cover.
- Secure the engine compartment fuse box cover.
- Connect the negative terminal of the battery.
- Fill the engine oil tank.



- Start the engine, keeping it idling.
 - Wait for the electric fans to start up at least once (engine temperature approximately 90°C).
 - Stop the engine.
 - Check the engine oil level, then top it up to the **MAX** notch marked on the dipstick.
 - Fit the trim panels on the engine compartment.
- After connecting the battery's negative terminal, the following self-learning operations must be carried out to ensure that certain connected devices acknowledge the system again:
 - Refer to section:
 - Component self-learning in the event of battery disconnection*
 - Fit the engine floor guard.
 - Engine floor guard*

LEFT-HAND SIDE ENGINE MOUNT

Removal

- Place the vehicle on the hoist.
- Remove the trim panels.



- Remove the floor guard beneath the engine.

Engine floor guard

- Undo the screws securing the catalytic converter to the exhaust manifold.

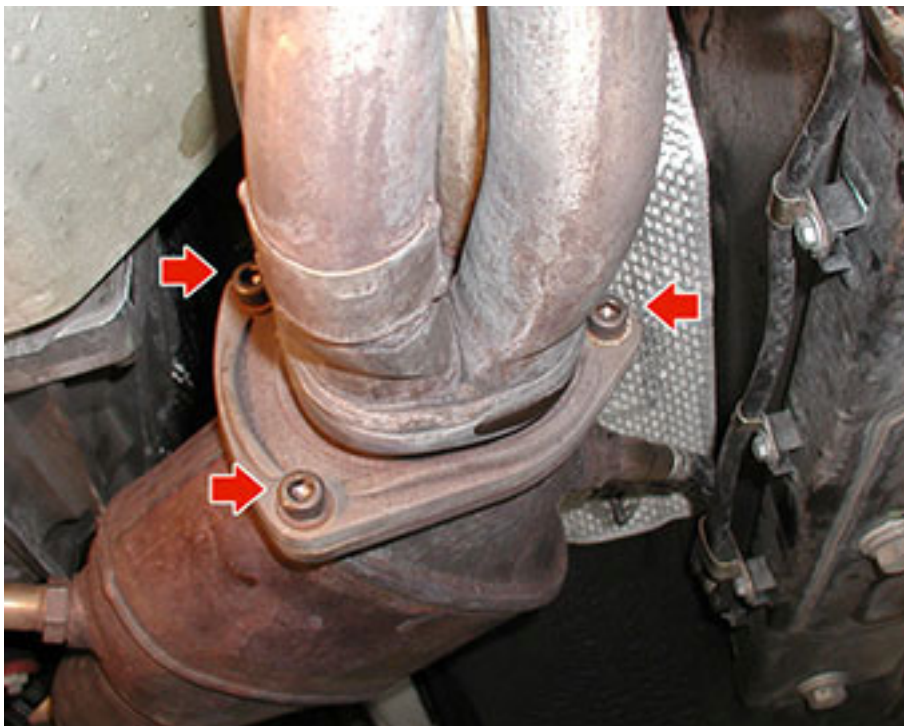

- Open the clamp and free the hydraulic steering system line.



- Remove the starter motor.
Starter motor
- Unscrew the nut that secures the mount to the dowel block.

N.B.

As this operation is difficult to carry out from the lower part of the vehicle, we recommend you perform it working from the upper part of the engine compartment, accessing the nut with a long wrench and a suitable bushing.



- Place a hydraulic supporting and lifting device **(1)** under the engine so as to work in safety.



- Undo the screws that secure the RH engine mount to the crankcase.



- All the retaining screws are easily accessible and there is no need to use any special wrench.



- Remove the LH engine mount.



Refitting

- Check that the component is intact.
- Fit the engine mount in its seat and tighten the retaining screws on the crankcase to a torque of **45 Nm**.
- Tighten the nut fastening the mount to the dowel block to a torque of **120 Nm**.



- Remove the hydraulic supporting and lifting device (1) positioned previously from under the engine.

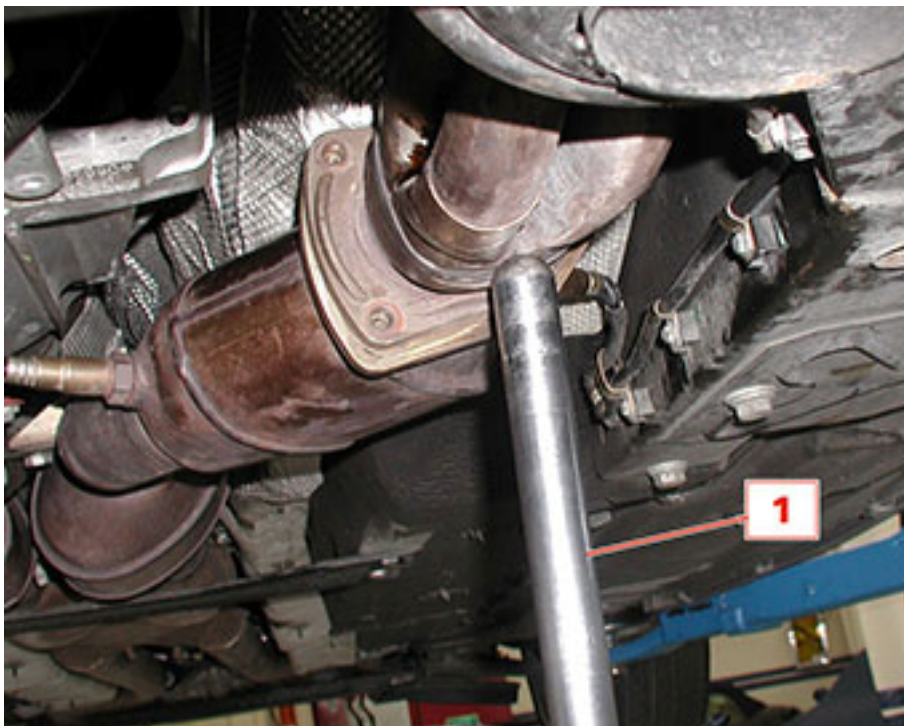

- Fit the starter motor.
Starter motor
- Secure the hydraulic steering system using the specific clamp.



- Tighten the screws fastening the exhaust manifold to the catalytic converter to a torque of **25 Nm**.

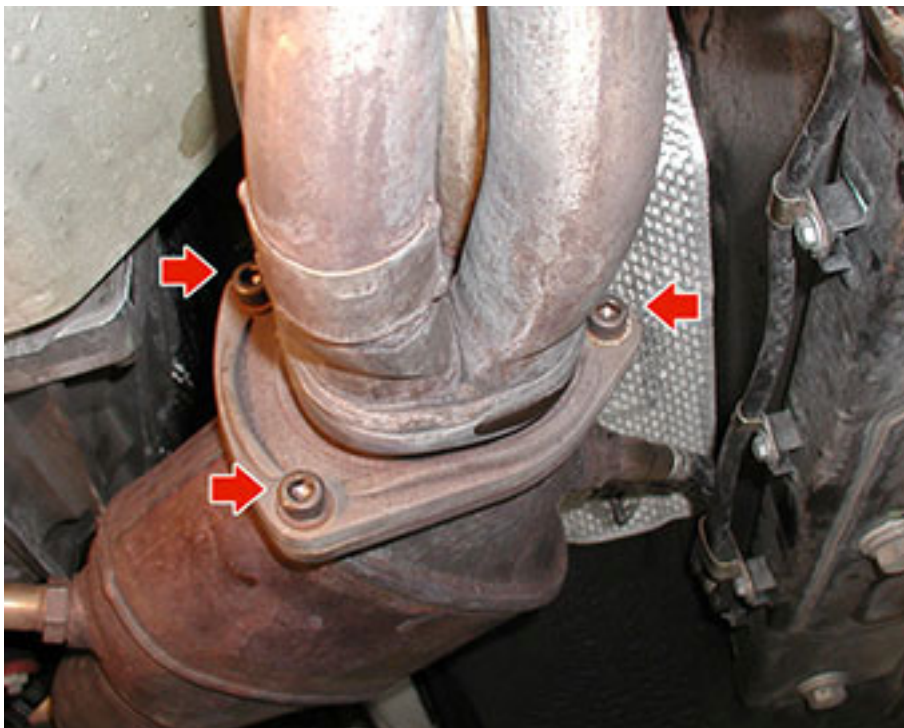

- Fit the engine floor guard.

Engine floor guard

- Fit the trim panels.
- Remove the vehicle from the hoist.

ELASTIC DOWEL BLOCK ON THE LEFT-HAND SIDE OF THE ENGINE

Removal

- Remove the LH engine mount.
Left-hand side engine mount
- Unscrew the two nuts that secure the dowel block to the frame and remove the dowel block.



Refitting

- Check that the component is intact.
- Fit the elastic dowel block and tighten the two nuts that secure the elastic dowel block to the engine frame to a torque of **50 Nm**.



- When refitting the elastic dowel block, be careful with its orientation on the frame.
- Fit the elastic dowel block in such a way that the pin (1) can be coupled to the hole (2) on the engine mount.

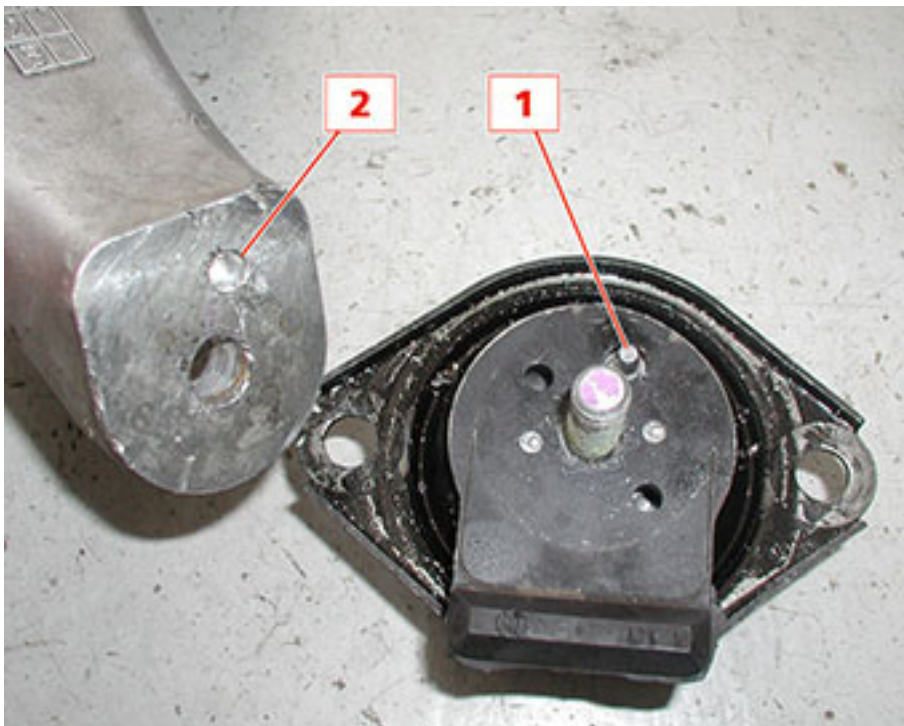

RADIATORS

Removing the radiators

- Place the vehicle on the hoist.
- After undoing the five fastening screws, remove the front grille.



- Unscrew the fastening on the buzzers, detach the electrical connections and then remove the buzzers.

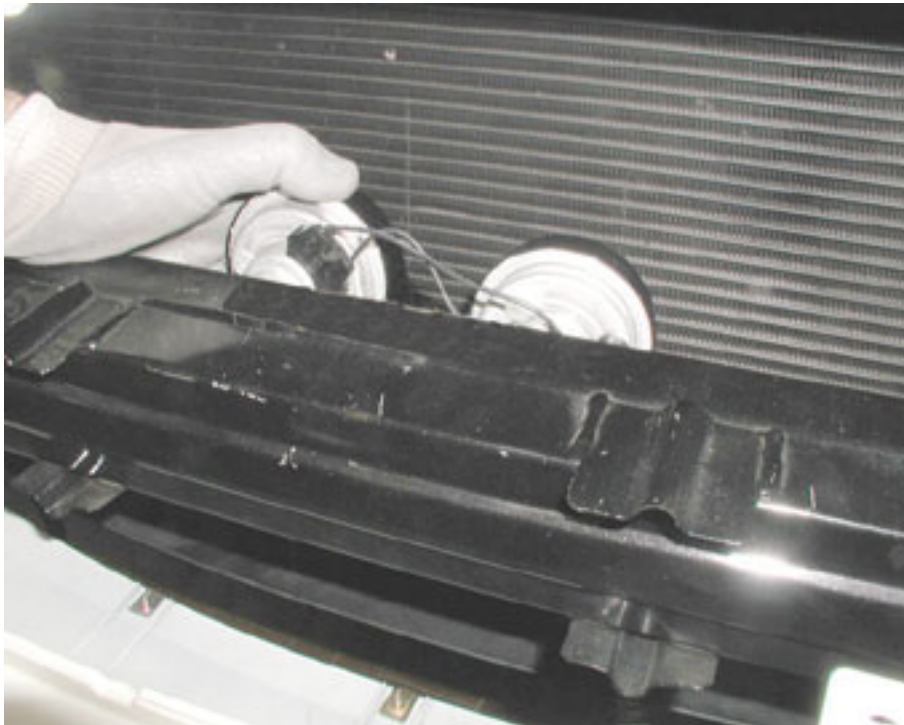

- Bleed the air conditioning system using the specific tool connected to the system's valves.

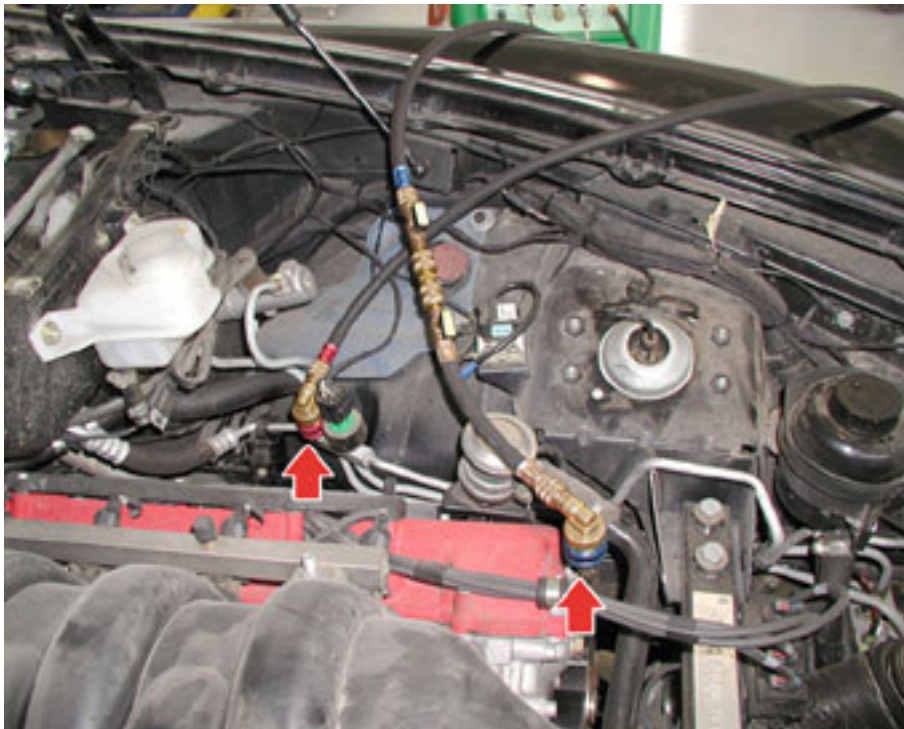

- Remove the floor guard beneath the engine
Removing-refitting the engine floor guard
- Undo the screw fastening the air conditioning system pipe to the dehydrator filter.



- Drain the system by unscrewing the relative plug.

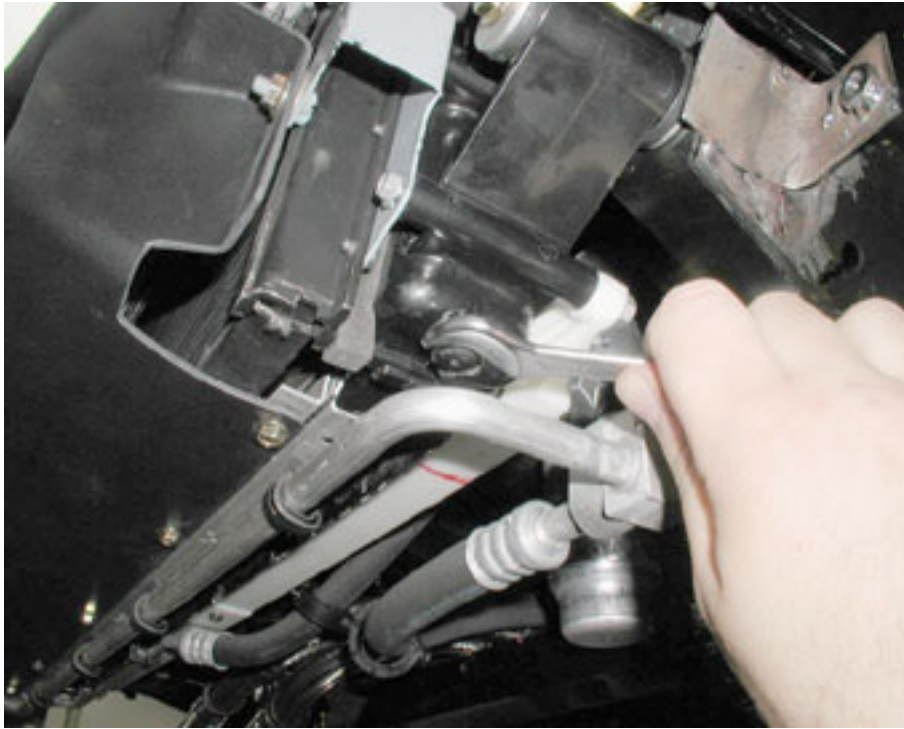

- Undo the screw fastening the air conditioning system pipe to the cooling coil.



- Detach the two cooling system fan connectors and the fan speed adjustment sensor.

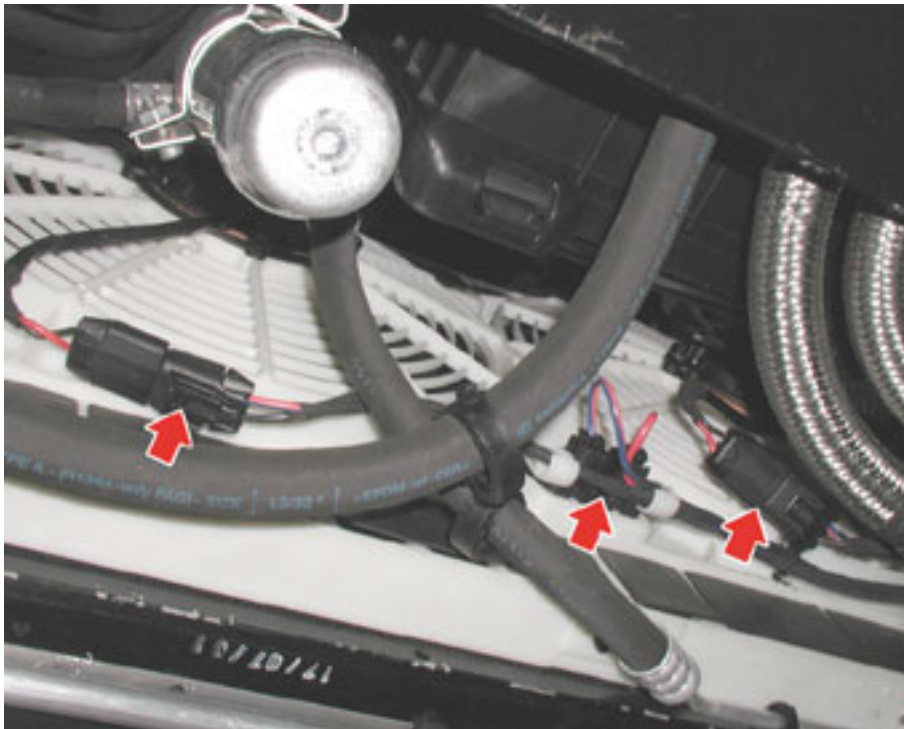

- Disengage the pipe connecting the expansion tank and the radiator.



- Undo the screw fastening the expansion tank.



- Unscrew the two upper radiator fastening nuts.



- Loosen the clamp fastening the upper sleeve then disengage it.



- Loosen the clamp fastening the lower sleeve, then disengage it.

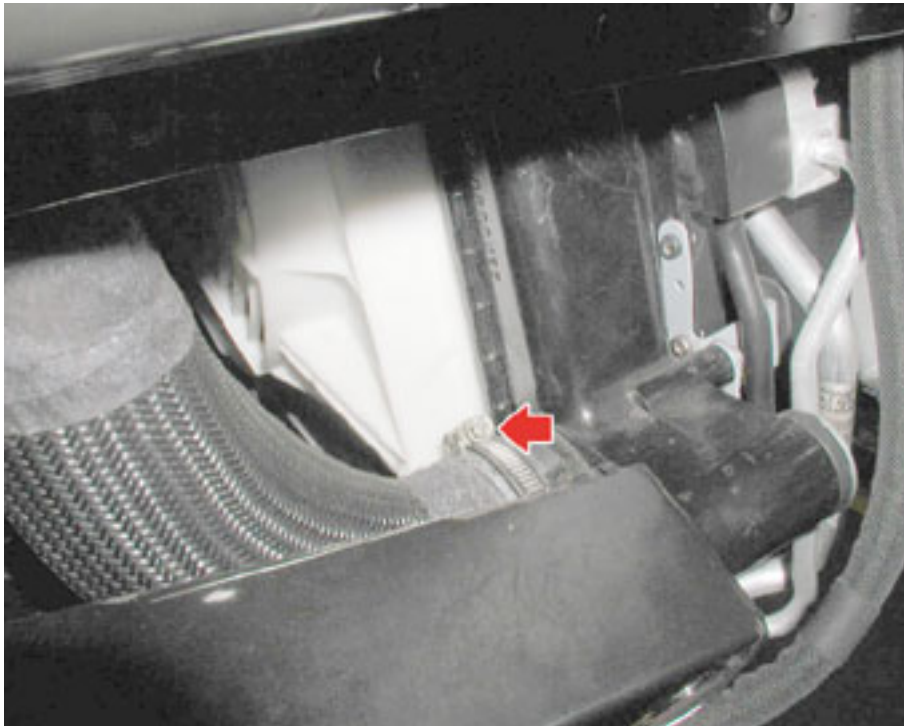

- Loosen the clamp fastening the hydraulic steering pipes, then disengage them, making sure you recover the liquid.

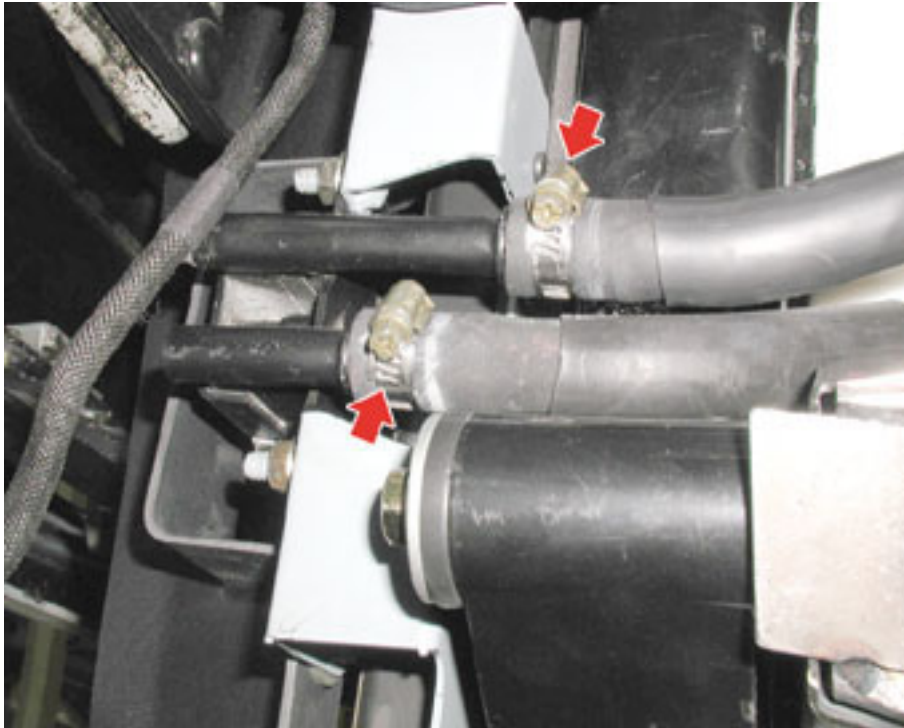

- Undo the two lower radiator fastening screws then remove them by sliding them out from the bottom.

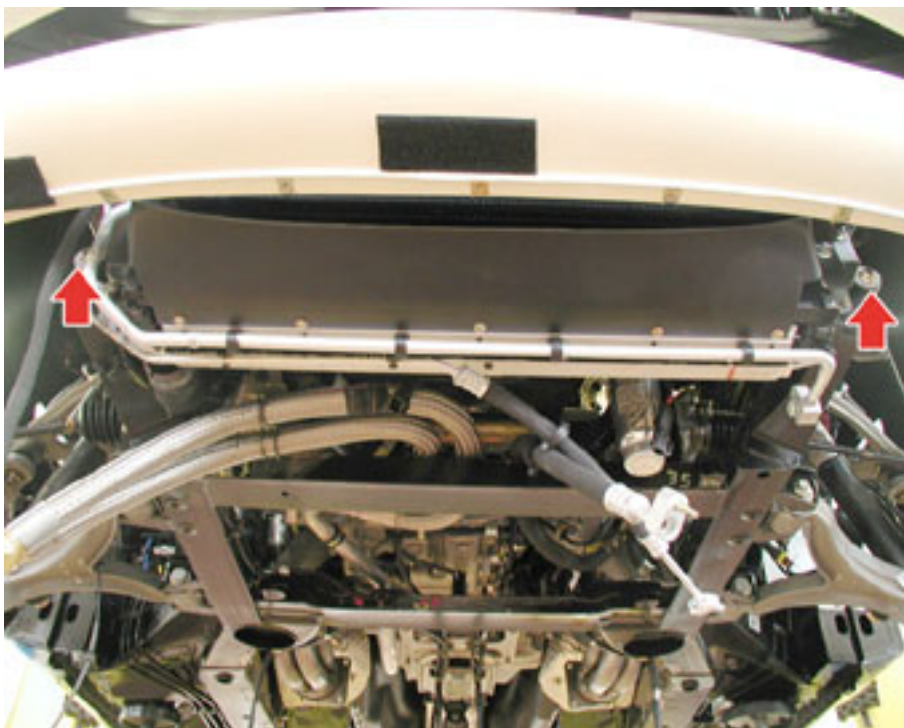

Refitting the radiators

- Fit the radiator- electric fan-condenser assembly and tighten the lower fastening screws.
- Connect the two hydraulic steering oil connection lines with the cooling system coil.
- Connect the lower and upper unions to the radiator.
- Tighten the upper fastening nuts on the radiator to a torque of **24 Nm**.



- Fit the engine coolant tank and tighten the fastening screw, then connect the pipe between the tank and the radiator
- Connect the two cooling system fan connectors and the fan speed adjustment sensor.
- Screw up the screw fastening the air conditioning system line to the cooling coil.
- Screw up the screw fastening the air conditioning system line to the dehydrator filter.
- Fit the horns and attach the electric connections.
- Fit the front grille and tighten the fastening screws.

- Connect the equipment used to fill the R134a fluid and run a vacuum cycle to remove all R134a residues or air that has entered. Upon completion of the vacuum cycle, proceed by filling the air conditioning system.



- Connect the battery's negative terminal.
- Open the engine coolant tank cap and pour in the fluid until it reaches the **MAX** notch marked on the tank.
- Working from inside the vehicle, set the maximum temperature (+32°C) for the air conditioning/heating system manually, from both the driver's and passenger control panels.

N.B.

This operation allows the engine coolant to flow in and out the heating/air conditioning system.



- Start the engine, keeping it idling.
- Wait until the electric fans start up at least once (engine temperature approximately 90°C) and the air that comes out the vents in the passenger compartment is warm.
- During this stage, the level of the coolant contained in the tank could drop below the **MIN** notch, so top it up and keep it level with the **MAX** notch.
- If you are unable to release all the air in the system, open the two breather caps positioned on the two cylinder heads (figure below).

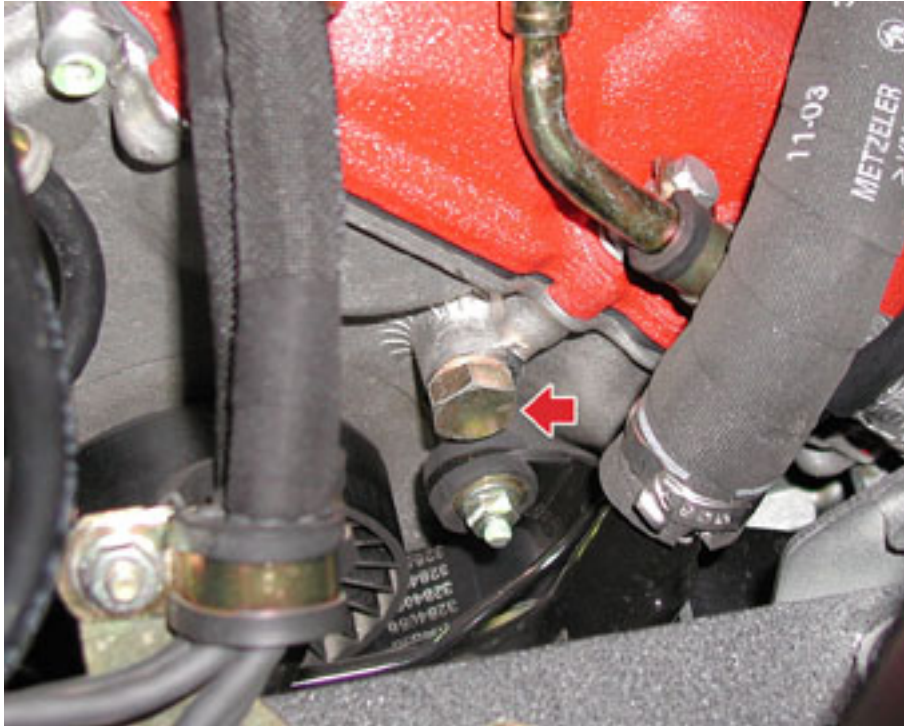

- Stop the engine.
- Check that the engine coolant is level with the MAX notch.
- Allow the engine to cool.
- Pour a suitable amount of oil into the hydraulic steering oil tank, until it reaches the MAX notch marked on the tank cap dipstick.
- The system is self-draining. Draining is carried out by turning the steering wheel as far as possible to the left, then to the right, doing this several times with the engine running and the vehicle stationary.
- Fit the trim panels on the engine compartment.

- After connecting the battery's negative terminal the following self-learning operations must be carried out to ensure that certain connected devices acknowledge the system again:
- Refer to section:

Component self-learning in the event of battery disconnection

- Fit the engine floor guard
- Removing-refitting the engine floor guard*

OIL FILTER

Detaching the oil filter

- Remove the cap and drain out the engine lubrication system oil.



- After undoing the three fastening screws, remove the guard.

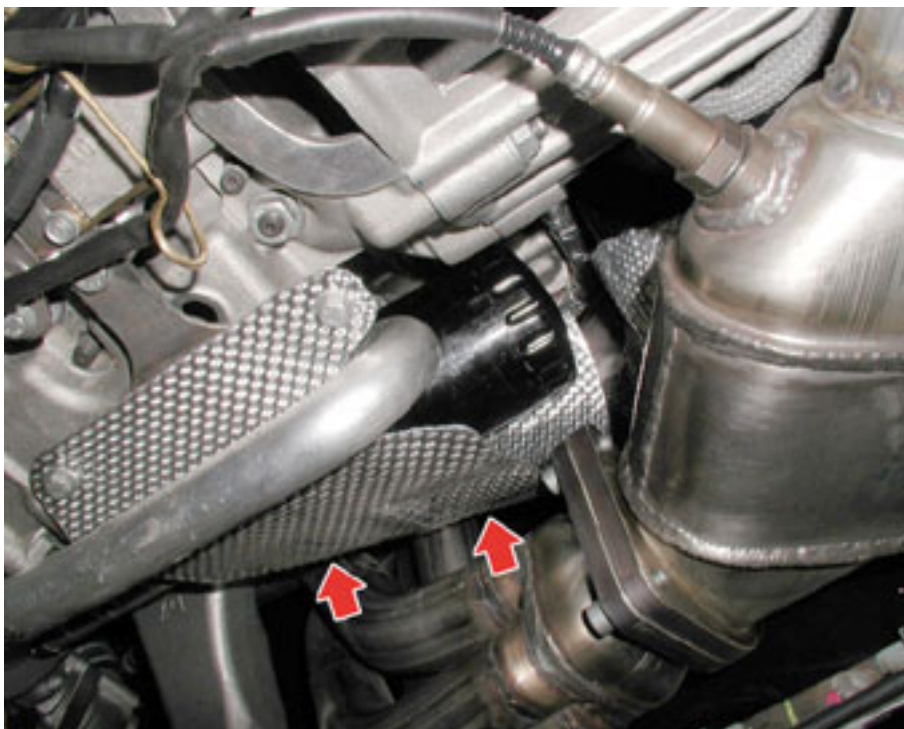

- Remove the oil filter using the relevant standard tool.

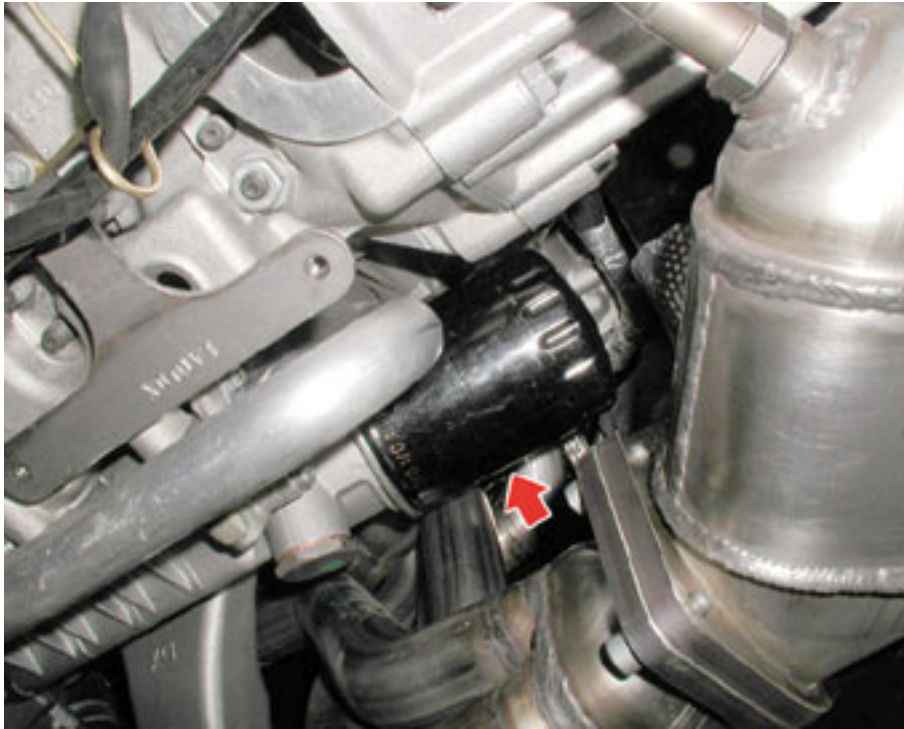

Refitting the oil filter

- Lubricate the oil filter surfaces using engine oil
- Fit the new oil filter, screwing it on manually.

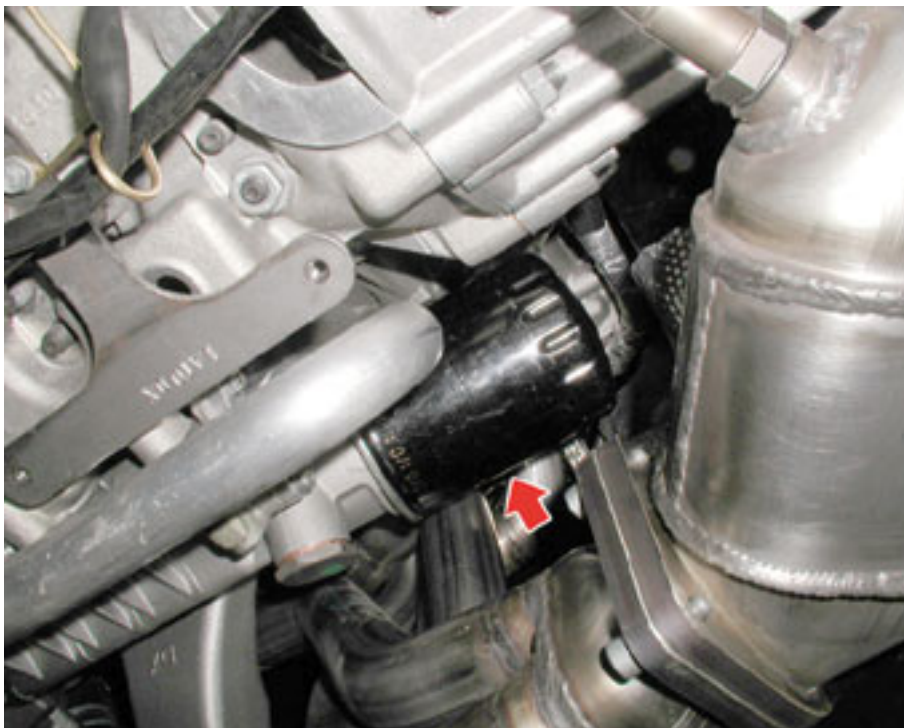

- Fit the guard on the engine oil filter.
- Connect the battery's negative terminal.
- Fill the engine oil tank.



- Start the engine, keeping it idling.
- Wait for the electric fans to start up at least once (engine temperature approximately 90°C).
- Stop the engine.
- Check the engine oil level, then top it up to the **MAX** notch marked on the dipstick.
- Fit the trim panels on the engine compartment.

- After connecting the battery's negative terminal the following self-learning operations must be carried out to ensure that certain connected devices acknowledge the system again:
- Refer to section:

Component self-learning in the event of battery disconnection

AIR FILTER

Removing-refitting the air filter

- Remove the trim guards.



- Detach the air flow meter electrical connection.



- Undo the screw fastening the air filter housing to the domes' bar.



- Remove the retaining clamp and release the two clips, then remove the air flow meter.



- After releasing the five locking clips, detach the cover from the housing.



- Extract the air filter from the relative housing.



N.B.

Before refitting the new air filter, clean the relative housing carefully.

When refitting, follow the above procedures in reverse order

WATER/ENGINE OIL PUMP

Removal

- Place the vehicle on the hoist.
- Remove the RH engine mount.
Right-hand side engine mount
- Drain the engine cooling system by unscrewing the relative cap.



- Undo the three retaining screws and detach the rigid union of the water pump line.



- Undo the screws that secure the water/oil pump to the engine crankcase and remove it.



- Use the specific tool **900027150** to undo the upper retaining screws.

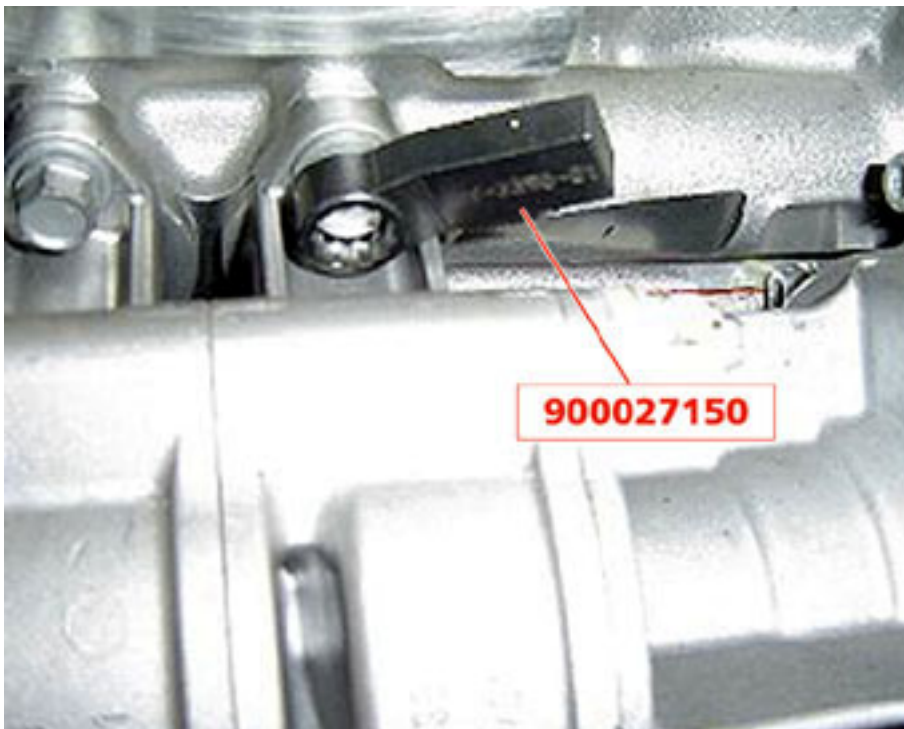

Refitting

- Check the oil-water pump to verify that there are no leakages from the draining holes.
- Check the groove on the oil/water pump shaft for wear.

N.B.

Always replace the pump OR.

- Lubricate the pump drive shaft with Molycote 1000 grease.
- Arrange the three O-Ring protection plates of tool **AV3602**.
- Fit the oil-water pump into its seat by inserting the shaft into the joint.
- Check that there are no signs of peeling of the O-rings in the area where the pumps join the crankcase. Fit the four M8x25 small headed screws to secure the unit to the crankcase, the two M8x65 screws to secure the pumps to the lower part of the crankcase and the three M8x25 screws to secure the pump to the crankcase, and at the same time remove the three plates **AV3602**.

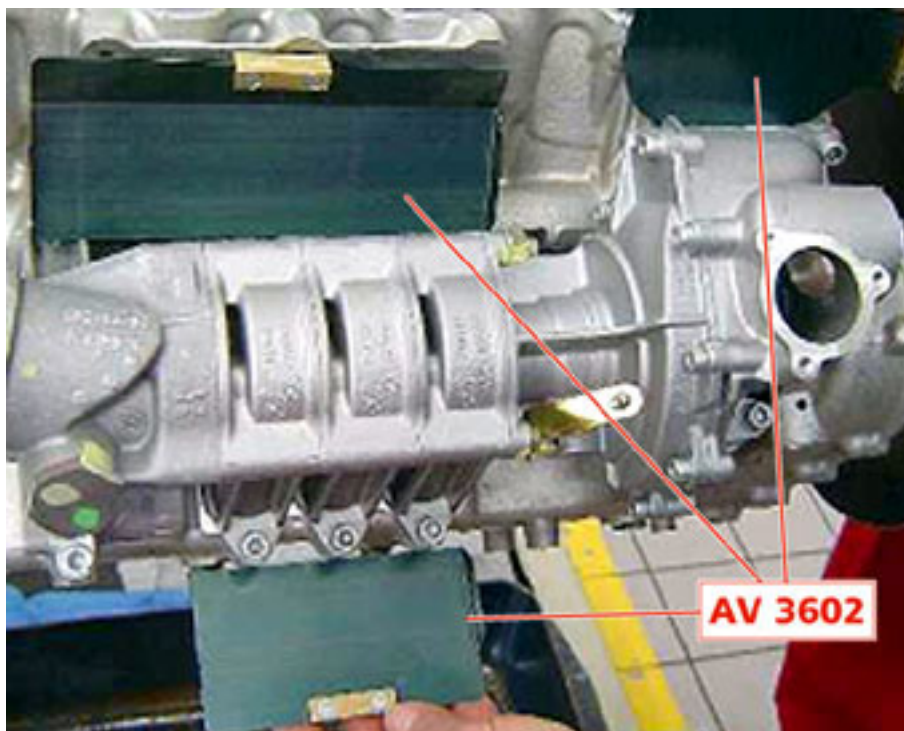

- Tighten the pump retaining screws to a torque of **25 Nm**, using tool **900027150** for the upper retaining screws.



- Connect the rigid union of the water pump line tightening the three retaining screws.

N.B.

Always replace the gasket



- Install the engine mount, right-hand side.

Right-hand side engine mount

- Open the engine coolant tank cap and pour in the fluid until it reaches the **MAX** notch marked on the tank.
- Working from inside the vehicle, set the maximum temperature (+32°C) for the air conditioning/heating system manually, from both the driver's and passenger control panels.

N.B.

This operation allows the engine coolant to flow in and out the heating/air conditioning system.



- Start the engine, keeping it idling.
- Wait until the electric fans start up at least once (engine temperature approximately 90°C) and the air that comes out the vents in the passenger compartment is warm.
- During this stage, the level of the coolant contained in the tank could drop below the **MIN** notch, so top it up and keep it level with the **MAX** notch.
- If you are unable to bleed all the air in the system, open the two breather caps positioned on the two cylinder heads (figures below).

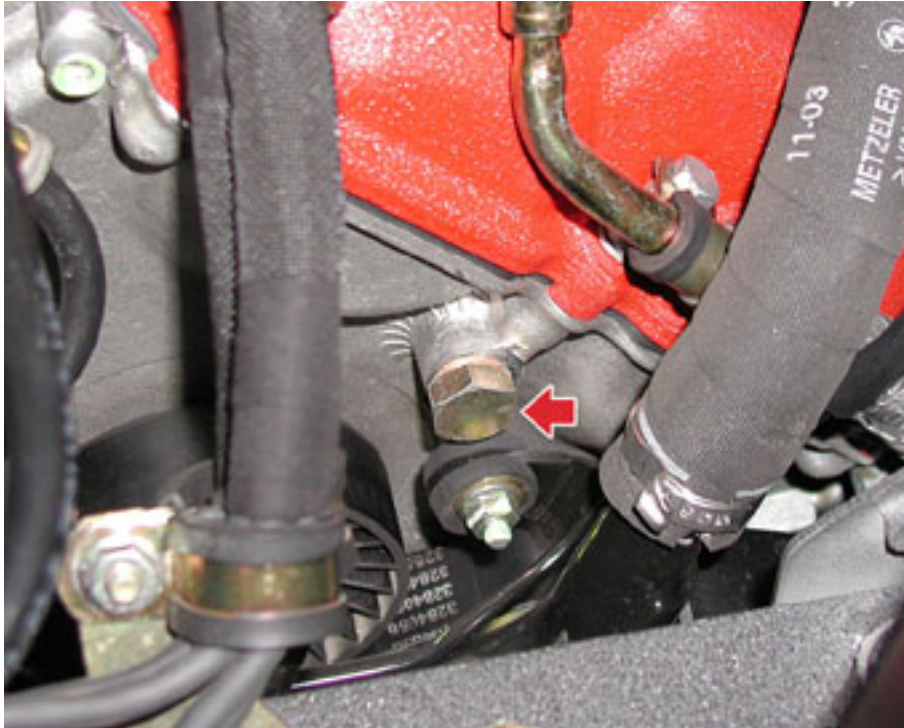

- Stop the engine.
- Check that the engine coolant is level with the **MAX** notch.
- Allow the engine to cool down.
- Fit the trim panels on the engine compartment.

TAILPIPE

Removing the tailpipe

- Place the vehicle on the hoist.
- Undo the two screws on the crossmember fastening the tailpipes and remove it. Then unscrew the clamp connecting the exhaust extension and the tailpipe.

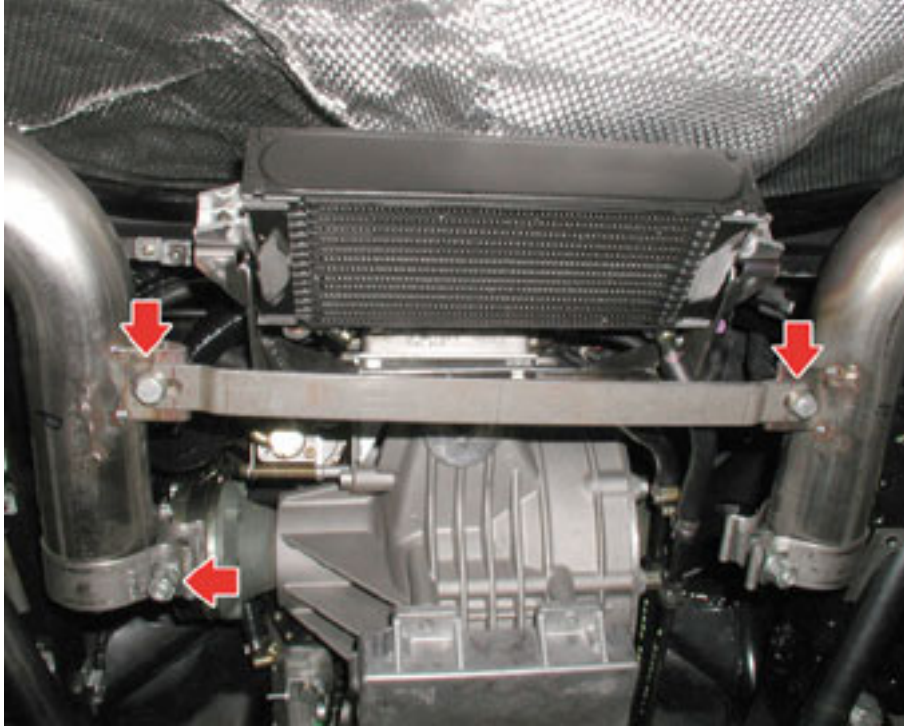

- Unscrew the two fastening screws on the front tailpipe support.

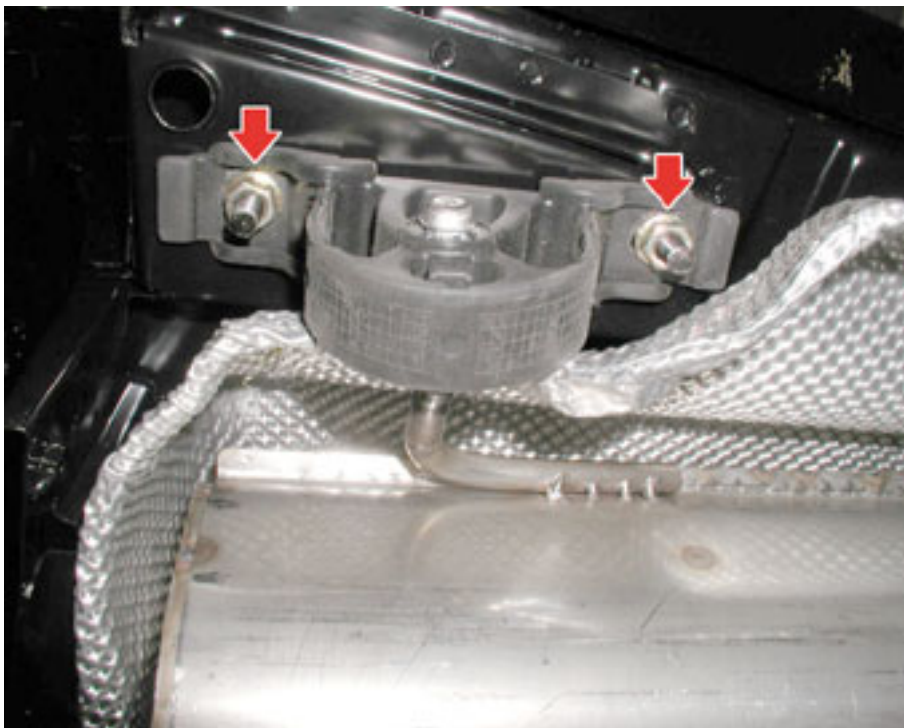

- Unscrew the two fastening screws on the rear tailpipe support then remove it, taking care not to damage the rear bumper.



Refitting the tailpipe

- Fit the exhaust tailpipes onto the exhaust extension pipes and screw on, without tightening them, all the screws and nuts fastening the mounts to the bodywork.
- Tighten the screws and the nuts fastening the mounts to the bodywork to a torque of **24 Nm**.

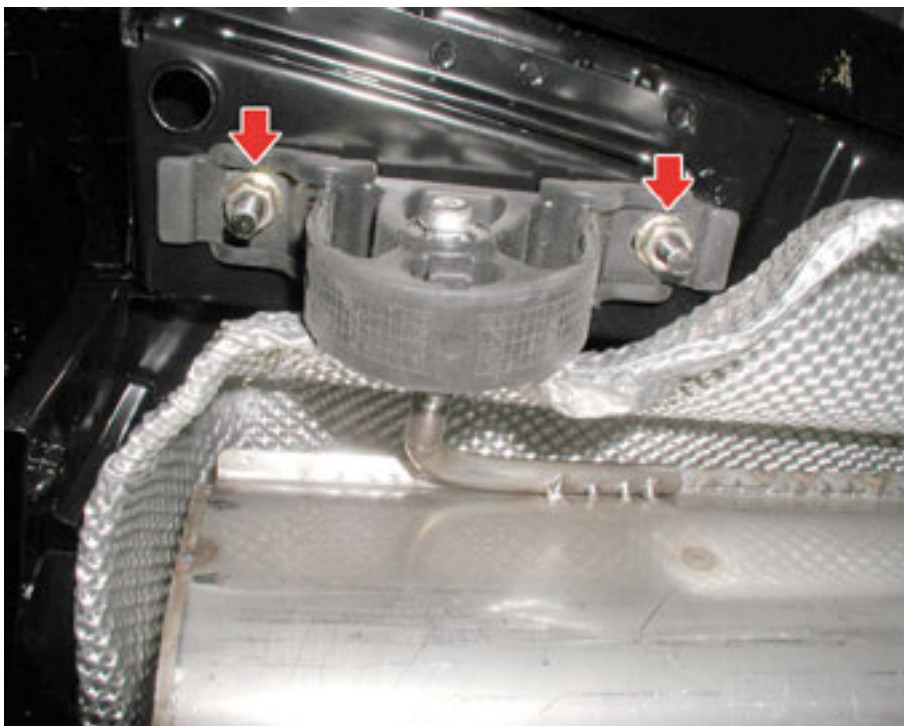

- Tighten the fastening nut on the clamp securing the tailpipe to the exhaust extension pipes to a torque of **54 Nm**.



- Fit the cross member and tighten the fastening screws.
- Remove the vehicle from the hoist.

CATALYTIC CONVERTER

Removing the catalytic converter

IMPORTANT

The procedure outlined here is followed by the procedure for the removal of the catalytic converters for the USA–CANADA version.

- Place the vehicle on the hoist.
- Undo the fastening screws on the bodywork reinforcement bracket.



- Release the front Lambda sensor wiring from the five clamps, then remove the front Lambda sensor.

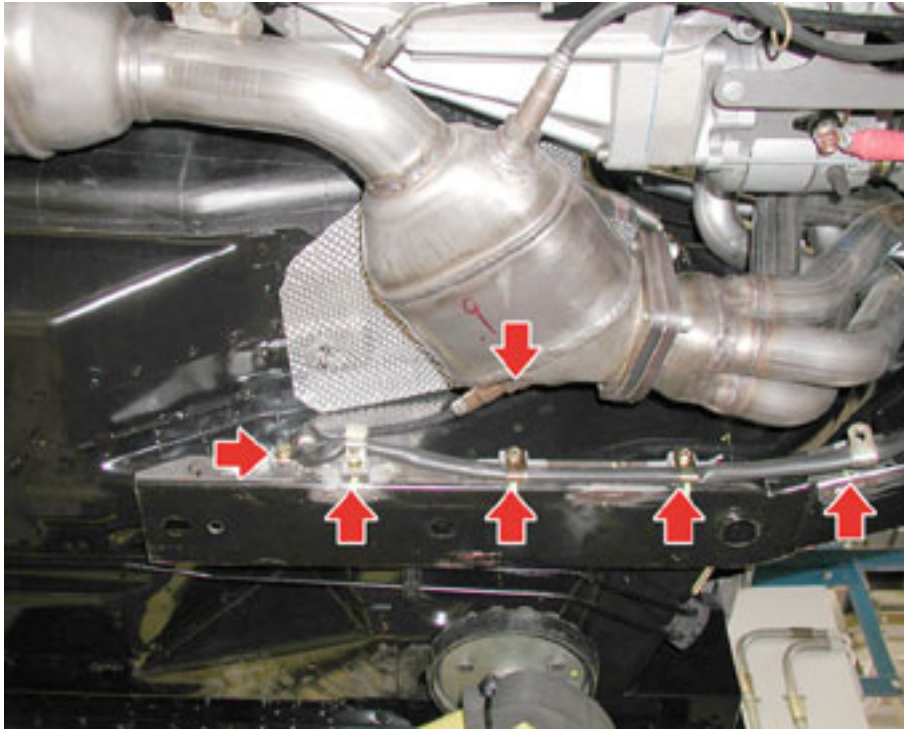

N.B.

When unscrewing the Lambda sensors, make sure the cables do not get damaged by twisting.

- Unscrew the rear Lambda sensor, then remove it.

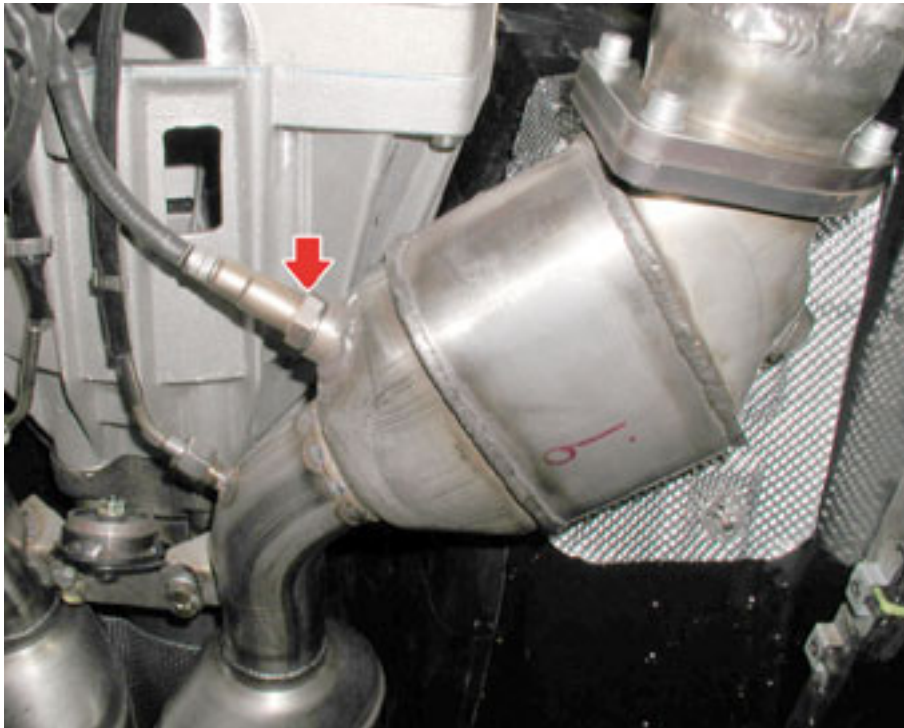

- Unscrew the two screws fastening the pipe to the central bracket



- Undo the three screws linking the exhaust manifold to the catalytic converter.
- Retrieve the gasket below.

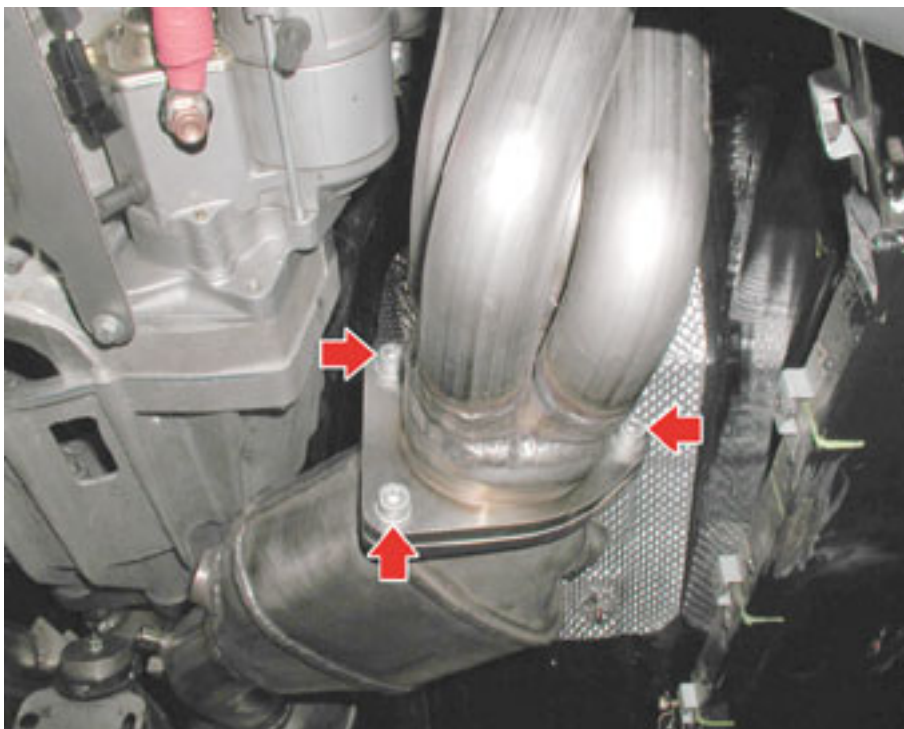

- Unscrew the clamp connecting the catalytic converters and the central silencer.

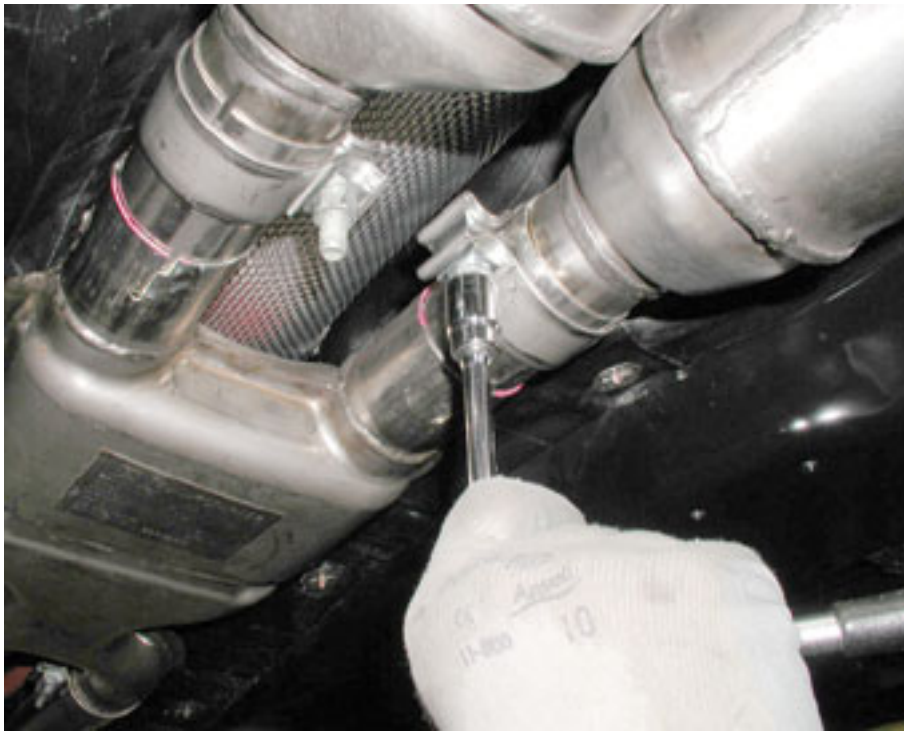

- Remove the catalytic converter concerned.

N.B.

Follow the same procedure for the remaining catalytic converter.

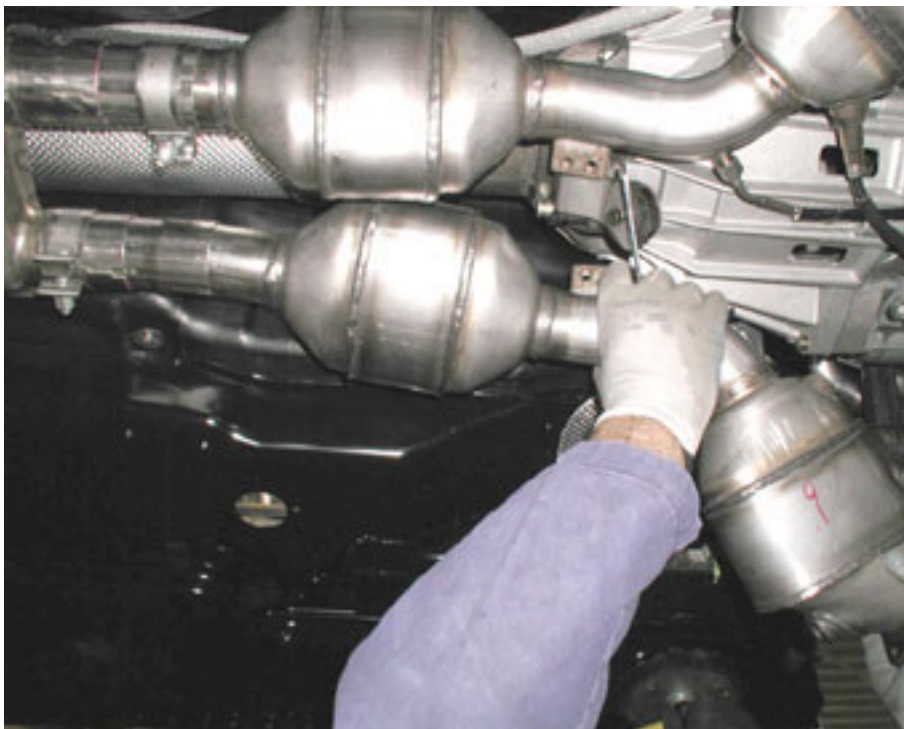

Refitting the catalytic converter

IMPORTANT

The procedure outlined here is followed by the procedure for the removal of the catalytic converters for the USA–CANADA version.

- Fit the catalytic converter removed into its seat on the central silencer and screw it in without tightening the fastening screws on the exhaust manifold flange.

N.B.

Visually inspect that the gasket located underneath the flange joining the catalytic converter and the exhaust manifold is intact and if signs of wear are found, replace it.

N.B.

The conductive gaskets must never be fitted more than once. The second time the component is fitted, they must be replaced

- Tighten the fastening nuts on the clamps securing the catalytic converter to the central silencers to a torque of **54 Nm**.

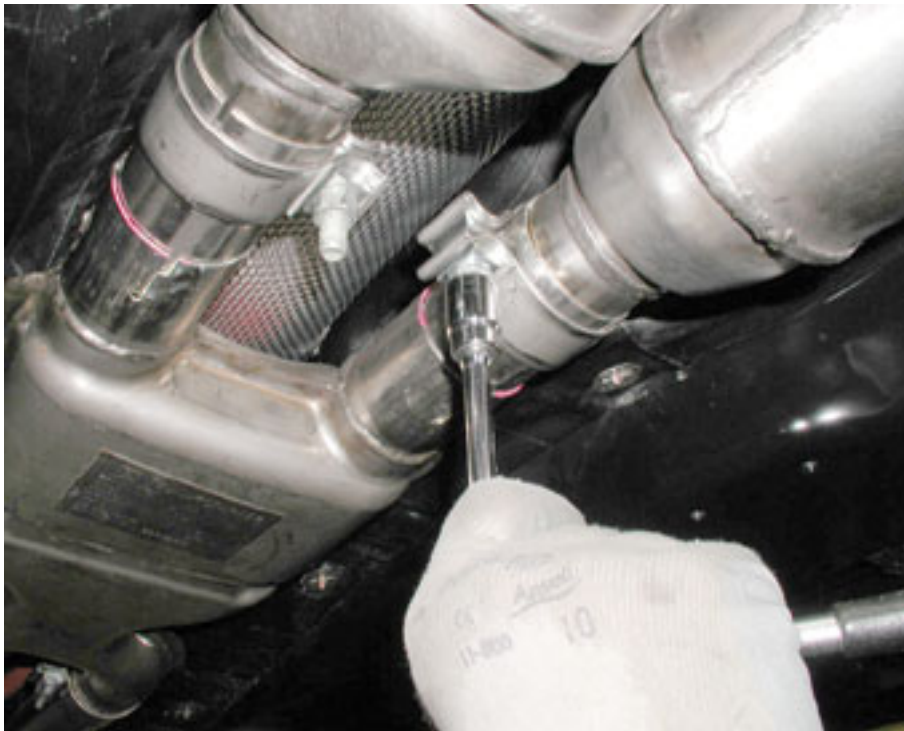

- Tighten the screws fastening the exhaust manifold to the catalytic converter to a torque of **25 Nm**.

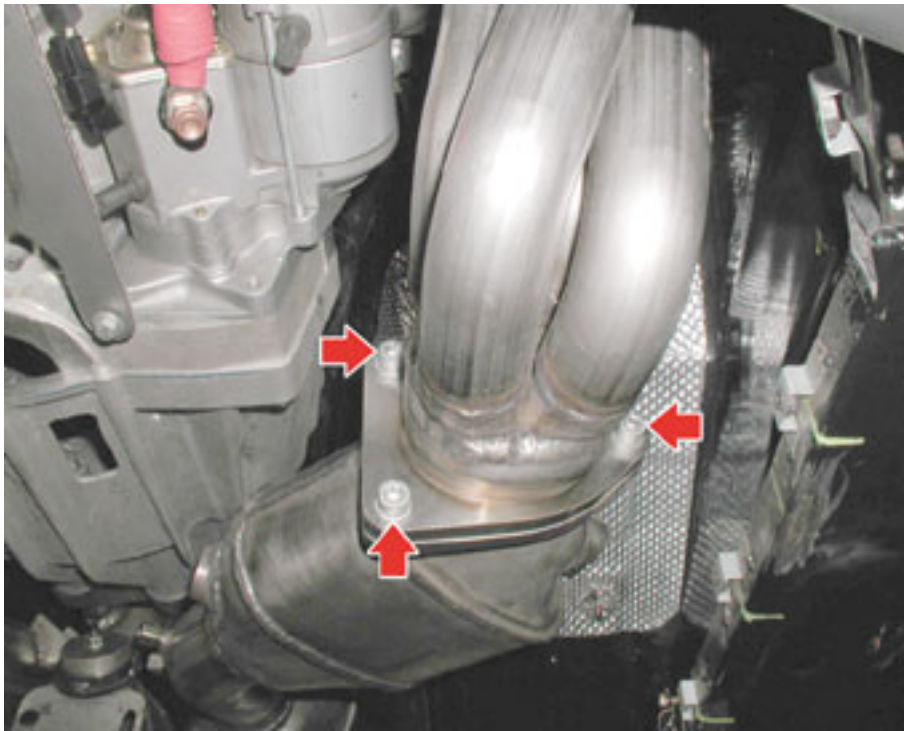

- Tighten the fastening screws on the central catalytic converter holder bracket to a torque of **25 Nm**.



- Fit the front and rear Lambda sensors, then tighten them to a torque of **50 Nm**.
- Fasten the front Lambda sensor wiring to the engine mounting frame correctly.



- Fit the bodywork reinforcement bracket and tighten the fastening screws to torque.



- Lower the hoist and remove the vehicle.

Removing the catalytic converter

IMPORTANT

The procedure below illustrates how to remove the catalytic converters for the USA–CANADA version.

USA - CANADA VERSION

- Place the vehicle on the hoist.
- Remove the exhaust tailpipes.
Tailpipe
- Remove the two exhaust extensions.
Exhaust extension pipe
- Remove the central exhaust silencer.
Exhaust silencer
- Remove the floor guard beneath the engine.
Engine floor guard
- Lower the hoist.
- Remove the trim panels.

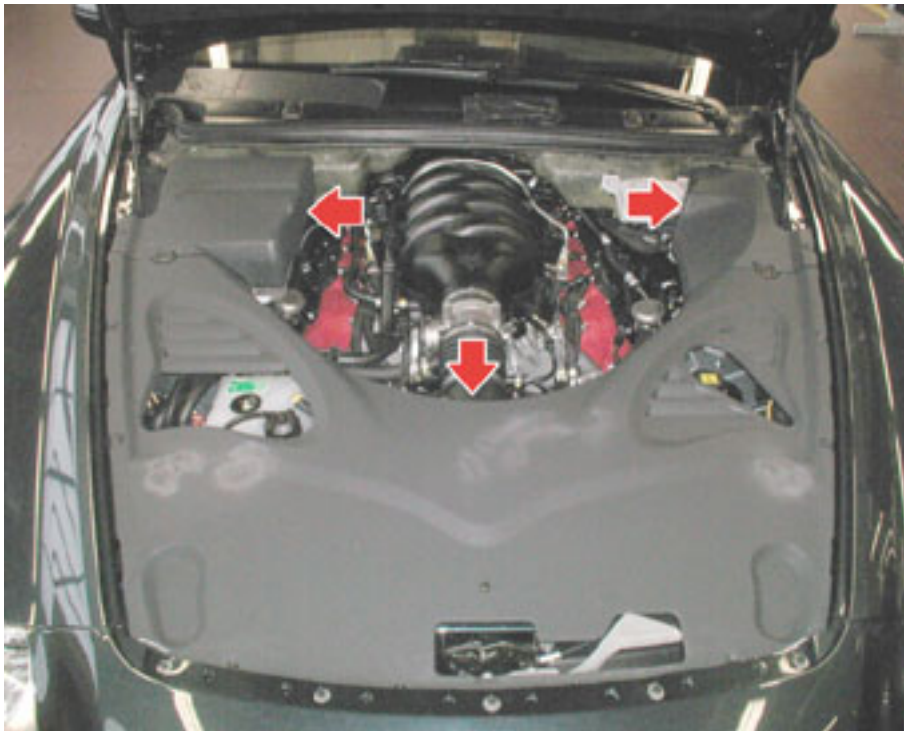

- Rotate the plastic fastening screws on the engine compartment fuse box cover by 90°, then remove the cover.



- Undo the two fastening screws on the engine compartment fuse box.



- Undo the three fastening screws and remove the engine compartment fuse box mount.



- Lift the hoist and remove the starter motor shield.



- Disconnect the electrical connector (1), undo the screws on the clamps (2) fastening the Lambda sensor wiring, then remove the lower LH Lambda sensor (3).

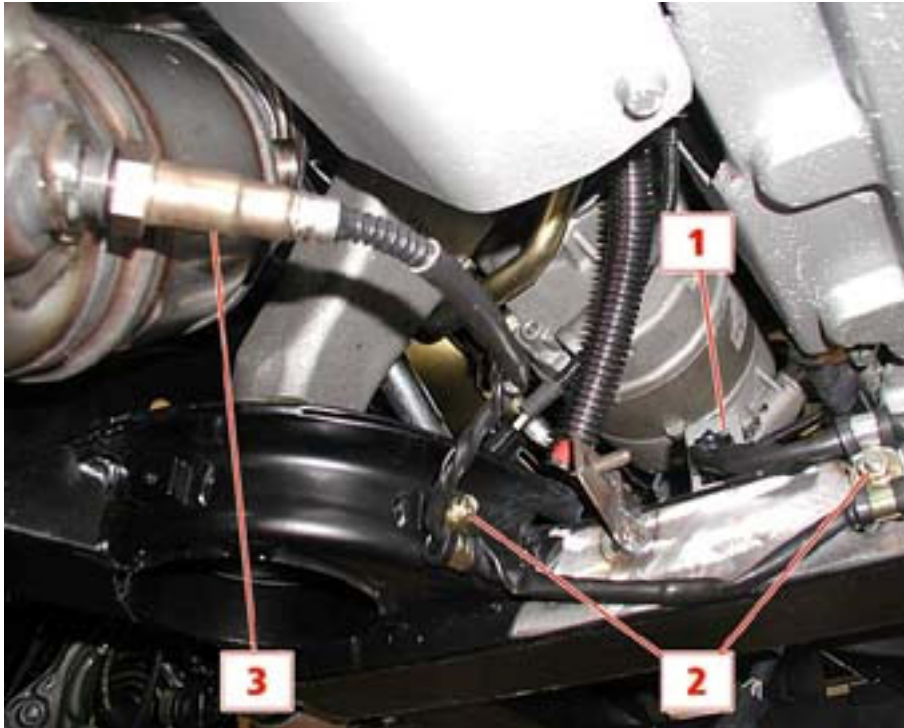

- Disconnect the electrical connector (1), undo the screws on the clamps (2) fastening the Lambda sensor wiring, then remove the lower RH Lambda sensor (3).

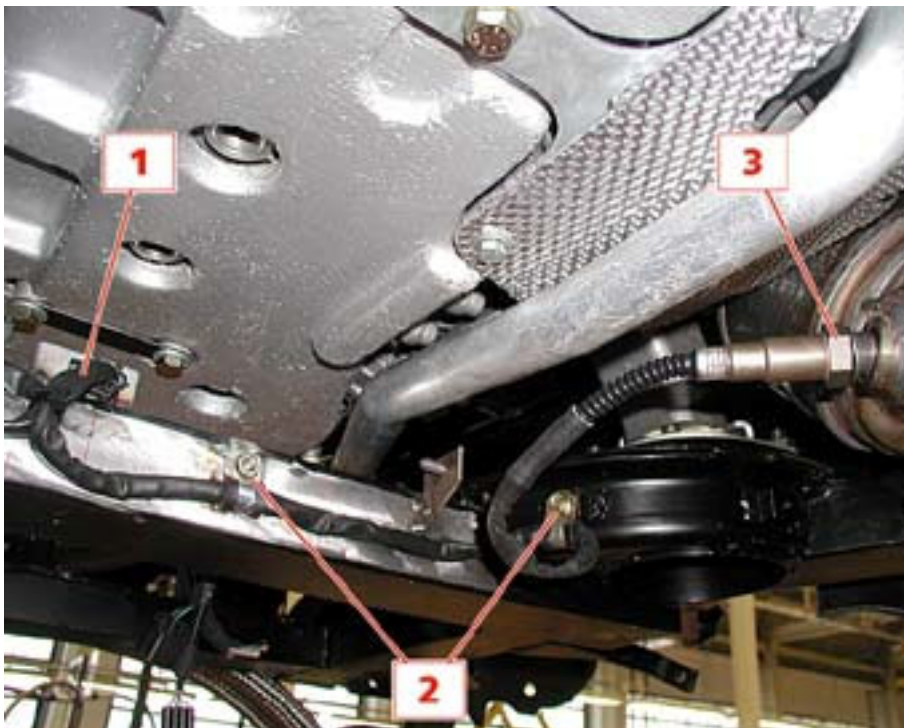

- Disconnect the electrical connector (1), undo the screws on the clamps fastening the Lambda sensor wiring, then remove the upper LH Lambda sensor (2).



- Disconnect the electrical connector, undo the screws on the clamps fastening the Lambda sensor wiring (1), then remove the upper RH Lambda sensor (2).



- Unscrew and remove the oil filter (1), then unscrew the fastening screws and remove the engine oil filter heat shield (2).

N.B

Place a container under the oil filter to collect the engine oil that is discharged. Carefully clean any surrounding components hit by the discharged engine oil.



- Working on the RH catalytic converter, prepare the wrench required to access the fastening.
- View of the fastening nuts on the RH catalytic converter.

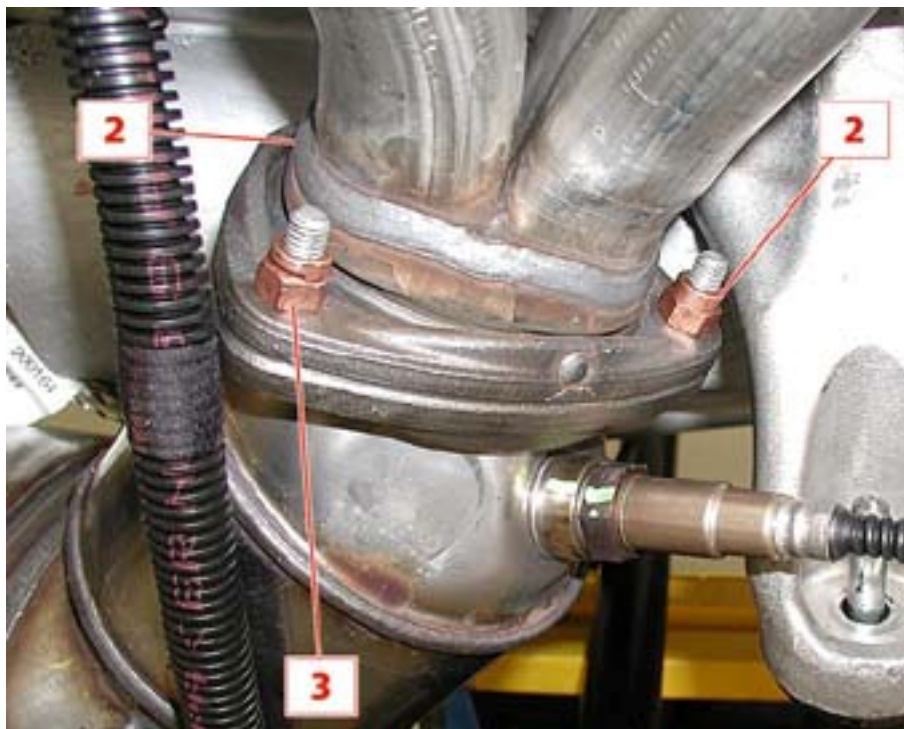

- To unscrew the nut (**1 see previous figure**), use a 3/8 ratchet wrench, connecting a 250 mm long extension, a 3/8 universal joint and 3/8 bush with diam. 13 mm to it.
- Working from the lower side of the vehicle, unscrew the nut (**1 see previous figure**) fastening the exhaust manifold catalytic converter coupling.



- To loosen the nut (**2 see previous figure**), use a 3/8 ratchet wrench, with a 3/8 bush.
- To unscrew the nut (**2 see previous figure**), completely use a 1/4 ratchet wrench, with 1/4 bush.
- Working from the lower side of the vehicle, unscrew the nut (**2 see previous figure**) fastening the exhaust manifold catalytic converter coupling.



- Lower the hoist.
- To loosen the nut **(3)** use a 3/8 ratchet wrench, two 250 mm long extensions, a straight 120 mm long extension and a 120 mm long 8° jointed extension with a 3/8 bush with diam. 13 mm.
- Working from the lower side of the vehicle, unscrew the nut **(3)** (see previous figure) fastening the exhaust manifold catalytic converter coupling.



- View of the points at which the RH catalytic converter is fixed to the LH exhaust manifold.

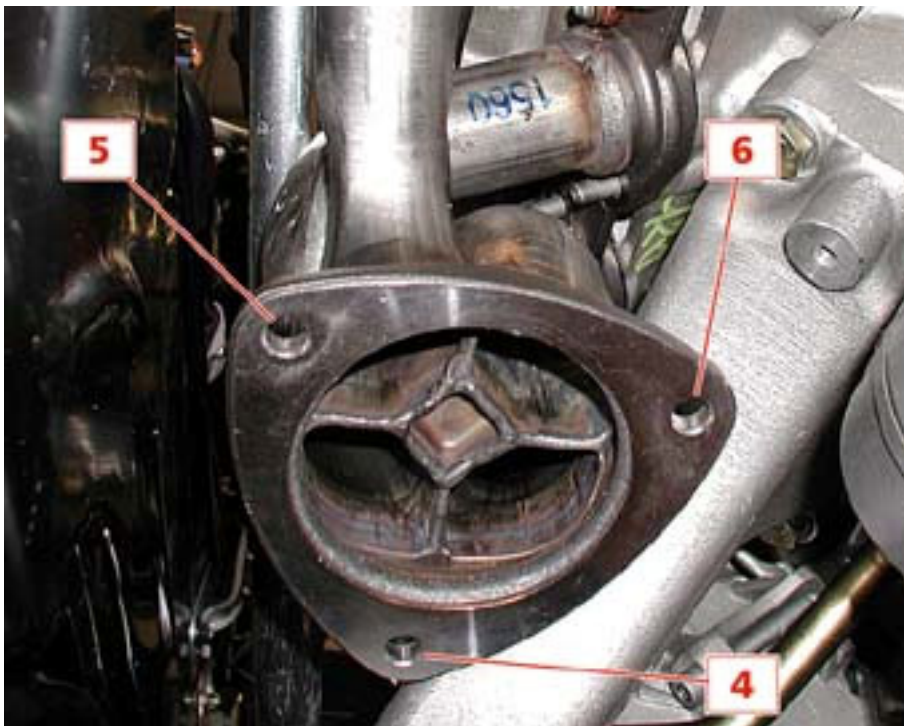

- Keep the hoist in the lowered position.
- To unscrew the nuts **(4)** and **(5)** use a 3/8 ratchet wrench, two 250 mm long extensions and a 120 mm long 8° jointed extension with a 3/8 bush with diam. 13 mm.
- Working from the upper side of the vehicle, unscrew the fastening nuts **(4)** and **(5)** on the exhaust manifold catalytic converter coupling.

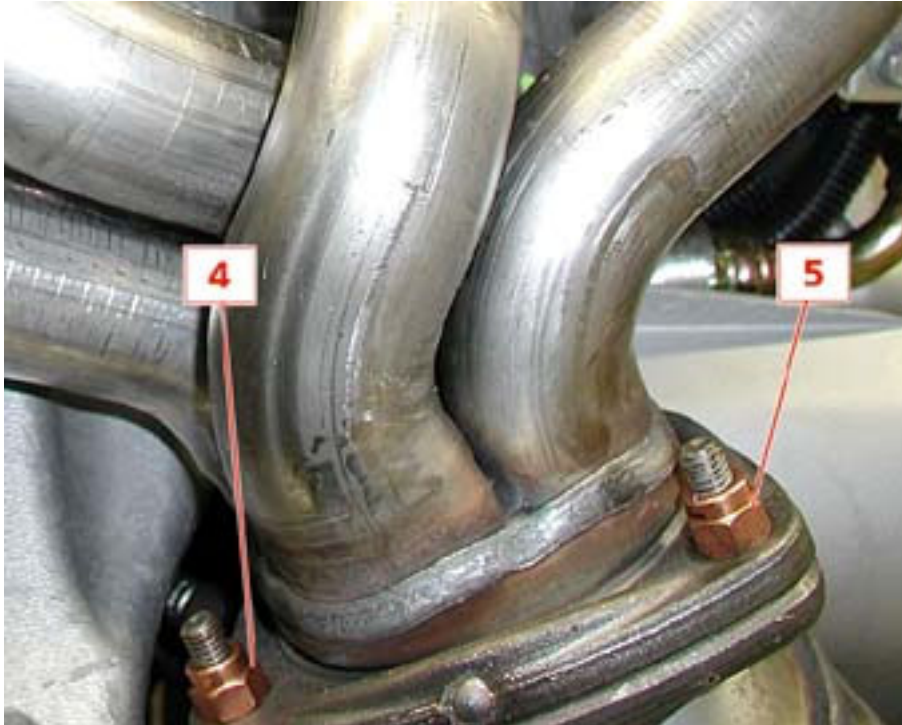

- Lift the hoist.
- Using 13 mm wrench, unscrew the nut **(6)** fastening the LH catalytic converter coupling to the relative manifold.

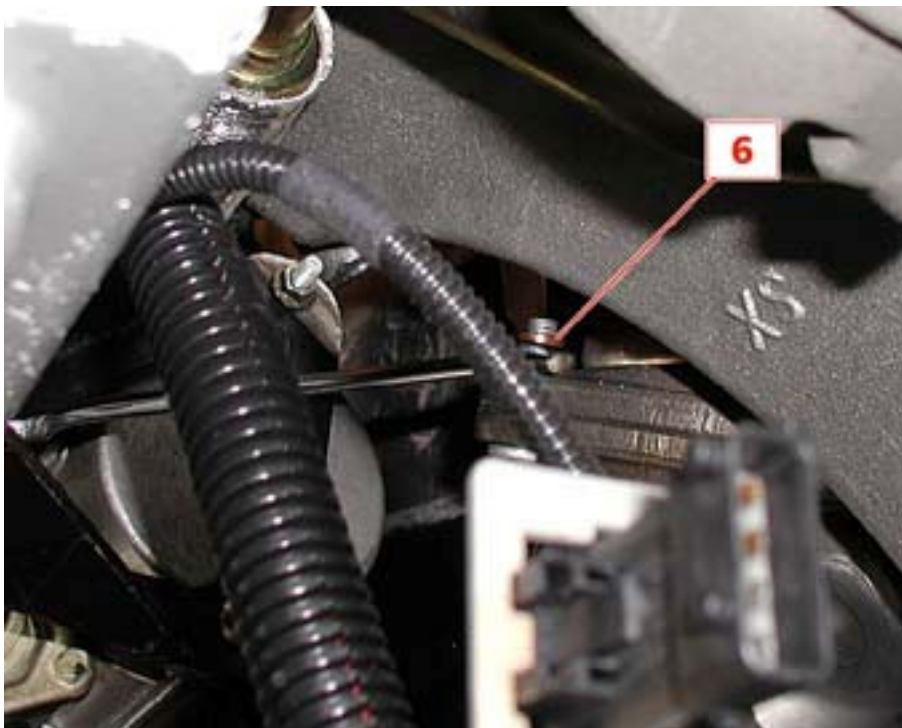

- Undo the screws fastening the catalytic converters onto the central mount.



- Remove the two catalytic converters from the lower part of the vehicle.



Refitting the catalytic converter

IMPORTANT

The procedure below illustrates how to fit the catalytic converters for the USA-CANADA version.

- **USA - CANADA VERSION**
- Fit the two catalytic converters into their seats on the exhaust manifolds.
- Fit the screws fastening the catalytic converters onto the central mount, then tighten to a torque of **25 Nm**.



- Using the same wrenches as instructed for the removal, screw in the fastening nuts **(1)**, **(2)**, **(3)**, **(4)**, **(5)** and **(6)** those fastening the catalytic converters to the relative manifolds, remembering to tighten them to a torque of **25 Nm**.

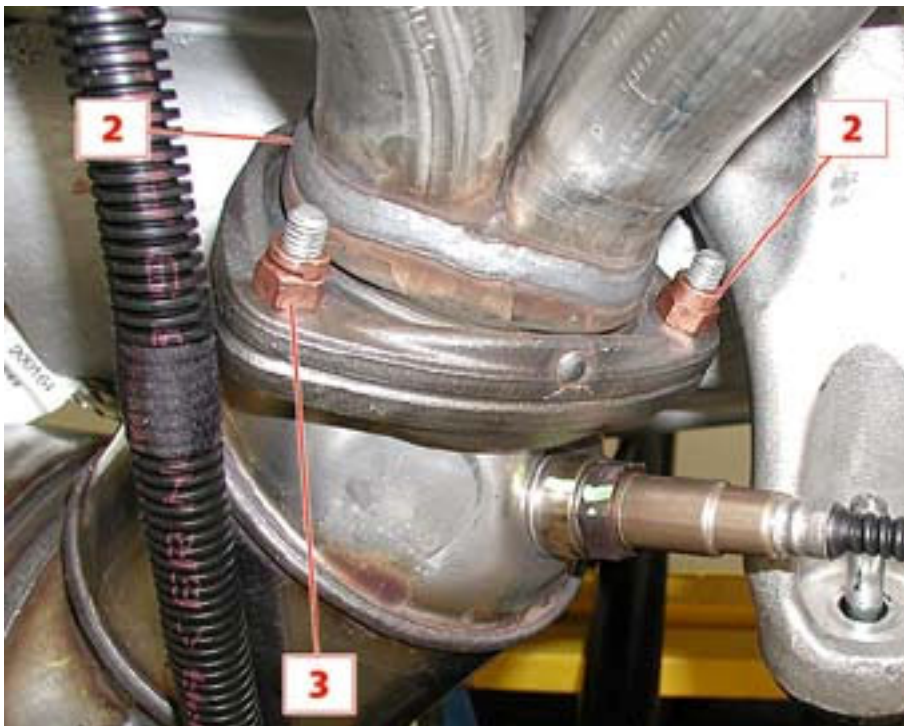

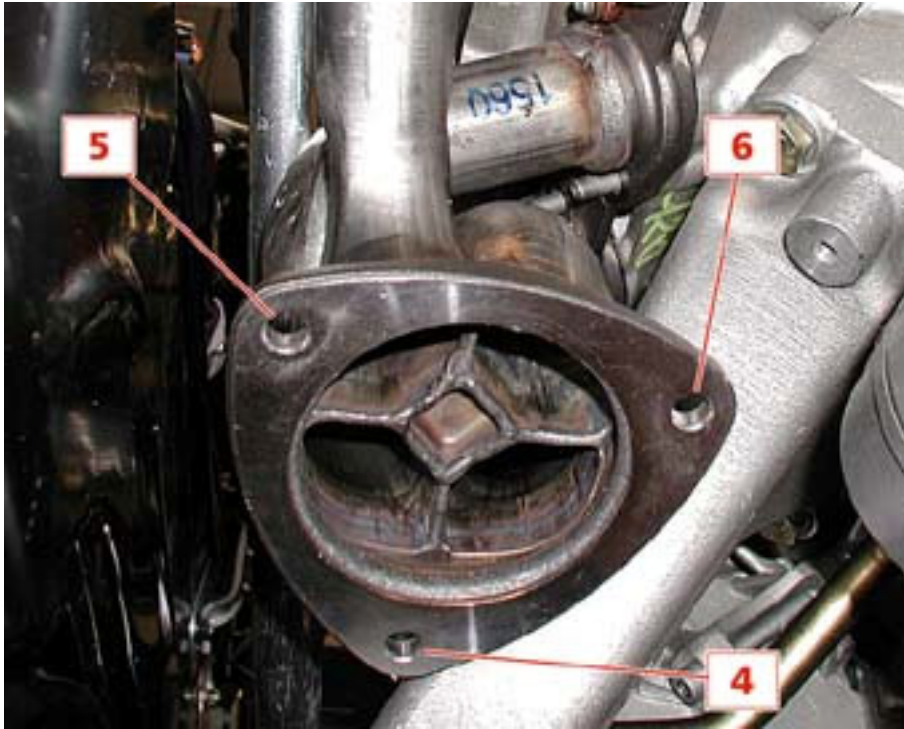

- Tighten the new oil filter(1) manually, then fit the engine oil filter heat shield (2).



- Fit the four Lambda sensors into their seats on the catalytic converters, tightening them to a torque of **50 Nm**, then wire up the electrical connections and fasten the wiring with the relative clamps.



- Fit the starter motor shield.



- Fit the engine compartment fuse box holder.



- Fit the engine compartment fuse box



- Fit the engine compartment fuse box cover.



- Fit the trim panels.

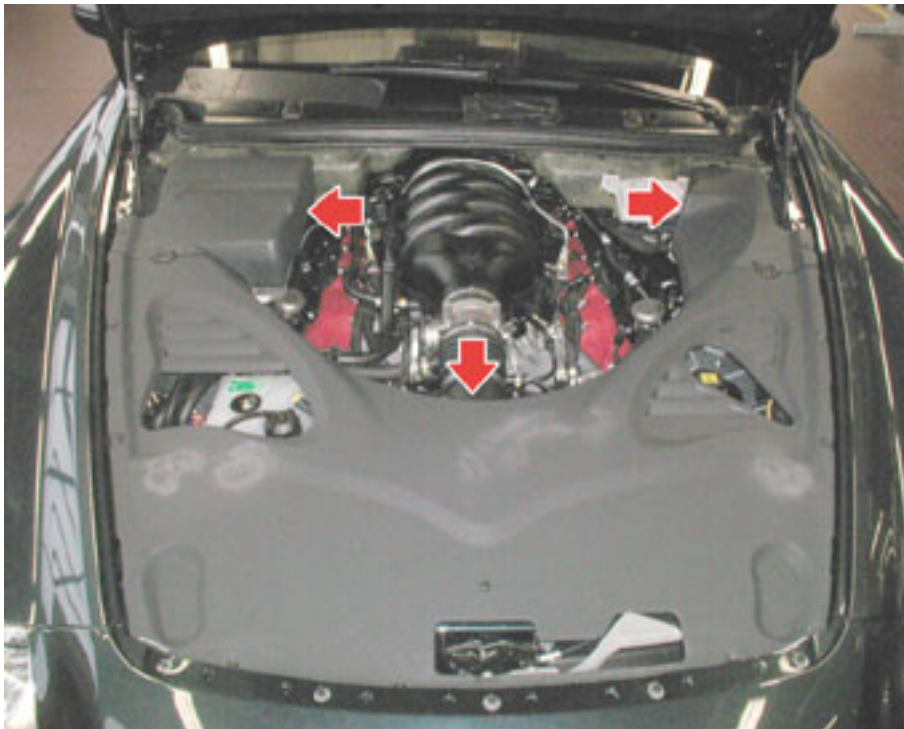

- Carry out the engine floor guard refitting procedure.

Engine floor guard

- Carry out the central exhaust silencer refitting procedure.

Exhaust silencer

- Carry out the refitting procedure for the two exhaust extension pipes.

Exhaust extension pipe

- Carry out the refitting procedure for the exhaust tailpipes.

Tailpipe

- Top up the oil in the engine oil tank (using the prescribed oil) to the MAX level on the dipstick.
- Remove the vehicle from the hoist.

CENTRAL SILENCER

Removing the central silencer

IMPORTANT

The procedure outlined here is followed by the procedure for the removal of the central catalytic converters for the USA –CANADA version.

- Place the vehicle on the hoist.
- Remove both the catalytic converters.
- Removing-refitting the catalytic converter*
- Unscrew the two clamps connecting the exhaust extension pipes and the central silencer, then remove it.

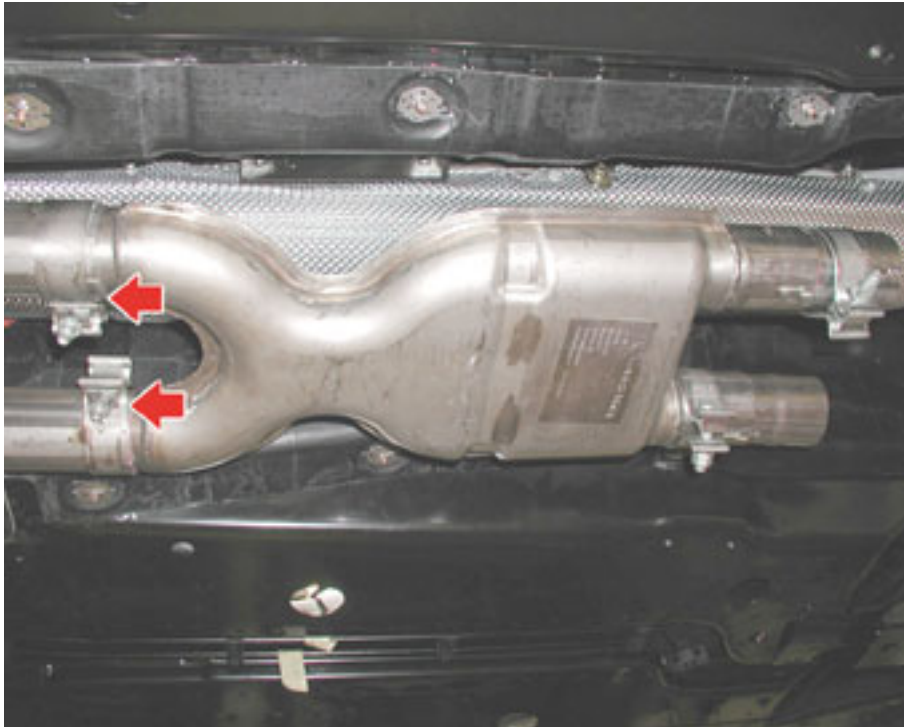

Refitting the central silencer

Fit the central silencer on the catalytic converter and tighten the fastening nuts on the clamps securing the silencers to the exhaust extension pipes to a torque of **54 Nm**



Removing the central silencer

IMPORTANT

The procedure below illustrates how to remove the central silencer for the USA-CANADA version

USA - CANADA VERSION

- Place the vehicle on the hoist.
- Remove the exhaust tailpipes.

Tailpipe

- Remove the two exhaust extensions.

Exhaust extension pipe

- Unscrew the two linking clamps between the central silencer and the catalytic converters, then remove the central silencer.



Refitting the central silencer

- Fit the central silencer on the catalytic converter and tighten the fastening nuts on the clamps to a torque of **54 Nm**.



EXHAUST EXTENSION PIPE

Removing the exhaust extension pipe

IMPORTANT

Further to the procedure described herein, we will describe the procedure for removing the exhaust extension pipes for the USA-CANADA version.

- Place the vehicle on the hoist.
- Remove both the catalytic converters.
Removing-refitting the catalytic converters
- Remove the central silencer.
Removing-refitting the central silencer
- Before removing the guard for the exhaust extension pipes, undo the fastening screws (five for the left-hand shield, two for the right-hand shield), then unscrew the clamp connecting the exhaust extension and the tailpipes.



- Unscrew the two fastening screws on the support, then extract the line.

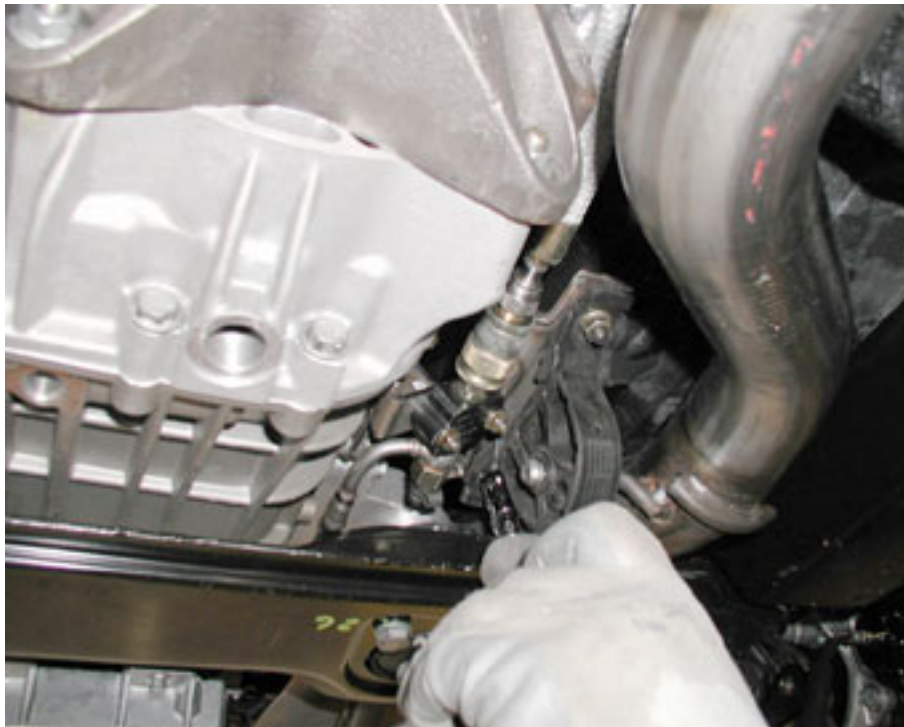

Refitting the exhaust extension pipe

- Fit the extension for the exhaust line into the rear silencers and tighten the screws fastening the mounts to the bodywork.
- Tighten the nut securing the tailpipe fastening clamp to the exhaust extension pipes to a torque of **54 Nm**.



- Tighten the screws fastening the mounts to the bodywork to a torque of **24 Nm**.



- Fit the central silencer.
Removing-refitting the central silencer
- Fit both catalytic converters.
Removing-refitting the catalytic converters
- Remove the vehicle from the hoist.

Removing the exhaust extension pipe

IMPORTANT

The procedure below illustrates how to remove the exhaust extension pipes for the USA-CANADA version.

USA - CANADA VERSION

- Place the car on the hoist.
- Remove the exhaust tailpipes.

Tailpipe

- Undo the fastening screws and remove the heat guard on the left-hand exhaust line.



- Undo the fastening screws and remove the heat guard on the right-hand exhaust line.

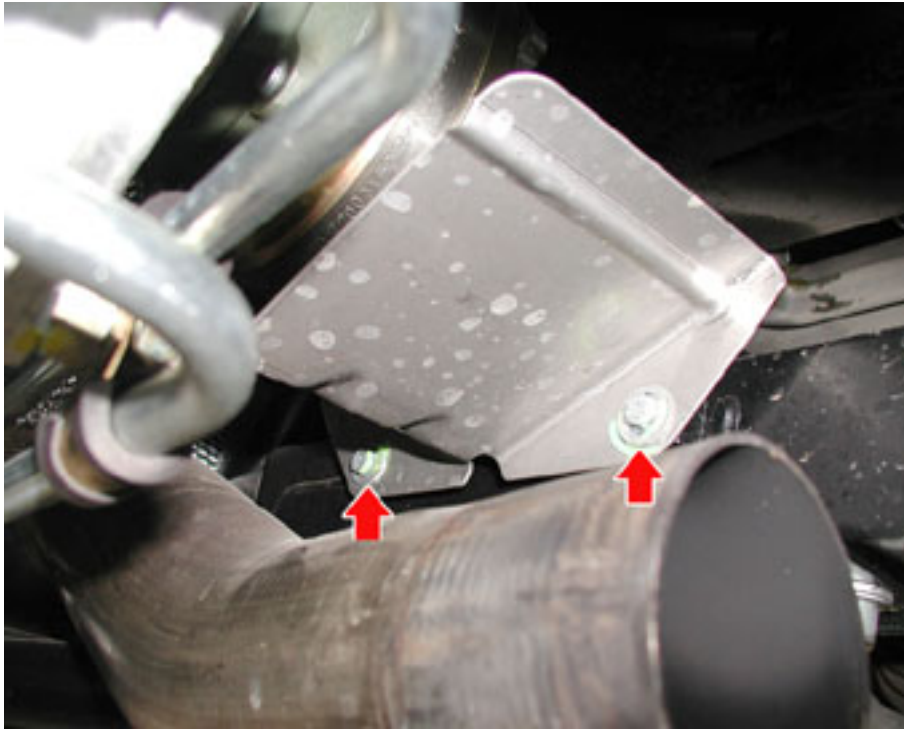

- Unscrew the nuts fastening the mount for the right-hand exhaust extension to the bodywork.
- Carry out the same operation for the left-hand exhaust extension by undoing the screws fastening the extension pipe to the bodywork.



- Unscrew the two nuts fastening the metal clamps joining the exhaust tailpipes and central silencers.



- Remove the two exhaust extensions.



Refitting the exhaust extension pipe

- Fit the exhaust tailpipes on the central silencers and tighten the fastening nuts on the fastening clamps to a torque of **54 Nm**



- Tighten the screws fastening the mounts to the bodywork to a torque of **24 Nm**.



- Fit the exhaust tailpipes.
Tailpipe
- Remove the vehicle from the hoist.

ELECTRO-INJECTORS

Removing the electro-injectors

- Disconnect the battery's negative terminal.
- Remove the trim panels.



- To remove the electro-injectors positioned on the right-hand side, proceed as follows.
- Remove the complete windscreen wiper unit.

Removing-refitting the windscreen wiper unit

- Rotate the plastic screws fastening the engine compartment fuse box cover by 90°, then remove the cover.



- Undo the two fastening screws on the engine compartment fuse box.



- Unscrew the three fastening screws, and remove the engine compartment fuse box mount.

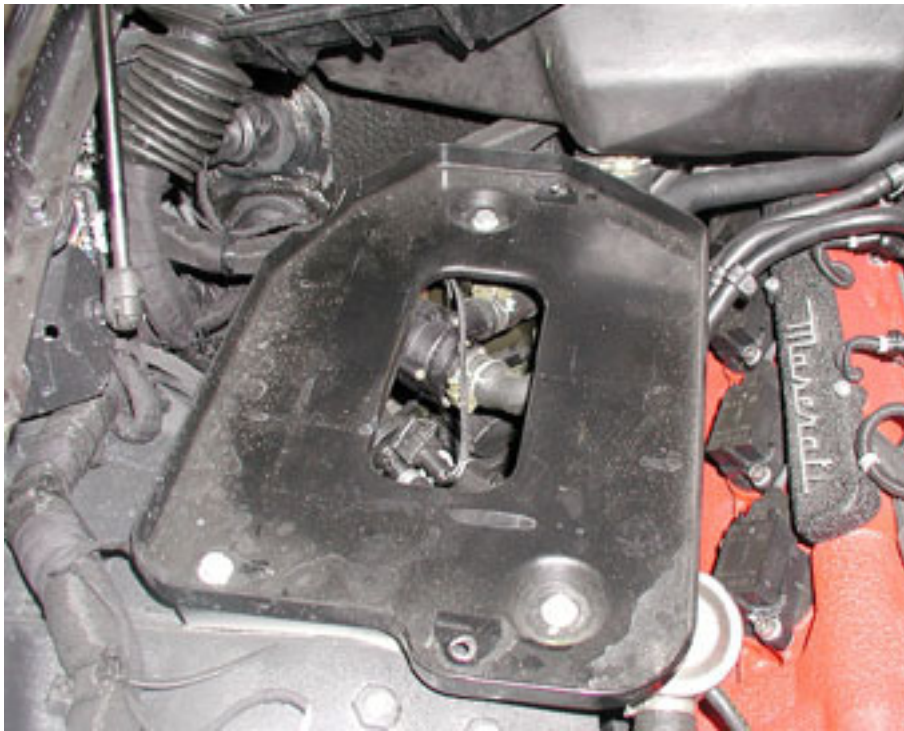

- Open the fastening clamps on the anti-evaporation / engine oil and fuel vapor recirculation system piping.



- Release the rigid fuel pipe from the two fastening clips.

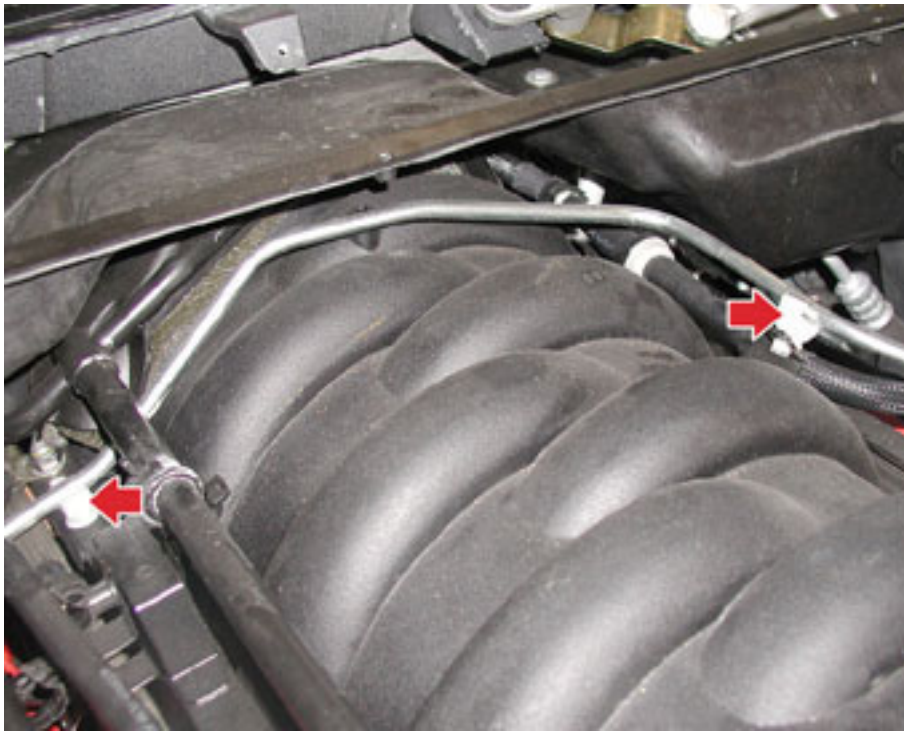

- Unscrew the fuel line union on the injector manifold.



- Unscrew the fastening nuts on the bracket and remove it.



- Unscrew the brake oil tank fastening screws.



- Detach the electrical connection.



- Undo the screws fastening the connected devices' pan underneath the windscreen.



- Undo the screws fastening the left-hand connected devices' pan underneath the windscreen and remove the pan.



- Detach the electro-injectors' electrical connections.



- Unscrew the fastening nuts on the fuel manifold.



- Remove the fuel manifold, complete with electro-injectors.



- With the fuel manifold on the bench, remove the clip and separate the electro-injector from the fuel manifold.



To remove the electro-injectors located on the left-hand side, proceed as follows.

- Unscrew the fuel line union, open the clamp and release the brake servo vacuum line.



- Unscrew the two fastening nuts on the bracket and remove it, opening the other two clamps fastening the brake servo vacuum line (not shown).



- Unscrew the two fastening nuts on the fuel connector and detach the electro-injectors' electrical connections.



- Remove the fuel manifold, complete with electro-injectors.



- With the fuel manifold on the bench, remove the clip and separate the electro-injector from the fuel manifold.



Refitting the electro-injectors

- To fit the electro-injectors positioned on the left-hand side, proceed as follows:
- Fit the fuel manifold, complete with electro-injectors, attach the electric connections and tighten the two fastening nuts to a torque of 15 Nm.



- Fit the bracket in the seat, connect the vacuum line to the two clamps (not shown) located near the shield, fully tighten the fastening nuts and secure the vacuum line with the last remaining clamp.



Tighten the fuel line union to a torque of **30 Nm**, and restrain the fuel line with the specific clip.



- To fit the electro-injectors positioned on the right-hand side, proceed as follows.
- Fit the electro-injectors on the fuel manifold, then mount the fuel manifold, tightening the nuts to a torque of **15 Nm**.



- Connect the electro-injectors' electrical connections.



- Fit the connected devices' pan underneath the windscreen and tighten the left-hand fastening screws fully.



- Tighten the screws fastening the right-hand connected devices' pan underneath the windscreen fully.



- Attach the electrical connection.



- Fit the brake oil tank and fully tighten the fastening screws.



- Fit the bracket and screw up the fastening nuts.



- Tighten the fuel line union on the injectors manifold to a torque of **30 Nm**.



- Restrain the rigid fuel pipe with the two fastening clamps.

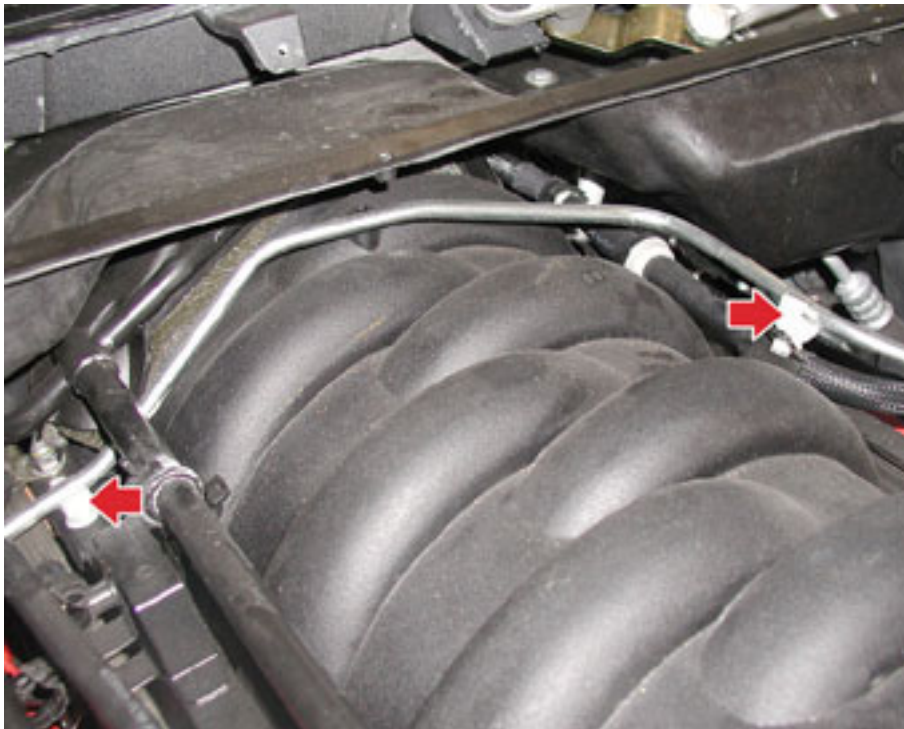

- Restrain the anti-evaporation / engine oil and fuel vapour recirculation system piping using the clamps indicated.



- Fully tighten the three fastening screws on the engine compartment fuse box.



- Fully tighten the two fastening screws on the engine compartment fuse box.



- Fit the fuse box cover and rotate the plastic screws by 90°.



- Fit the complete windscreen wiper unit.

Removing-refitting the windscreen wiper unit

- Connect the battery's negative terminal, turn the key to the ON position and perform a visual check to ensure there are no leaks from the injectors.
- Fit the engine compartment trim covers (this operation is the same for both procedures).



- After connecting the battery's negative terminal the following self-learning operations must be carried out to ensure that certain connected devices recognize the system again:
- Refer to the section:

Component self-learning in the event of battery disconnection

BATTERY

Disconnecting-reconnecting the battery

- Remove the right-hand internal flap.



- Remove the five fastening screws on the rear covering panel, then remove it.



- After removing the spare wheel housing cover, unscrew the covering panel's six fastening screws and remove it.



- Remove the right-hand cover, releasing the upper fastening button first.



- Unscrew the two fastening nuts on the battery's retaining bracket.

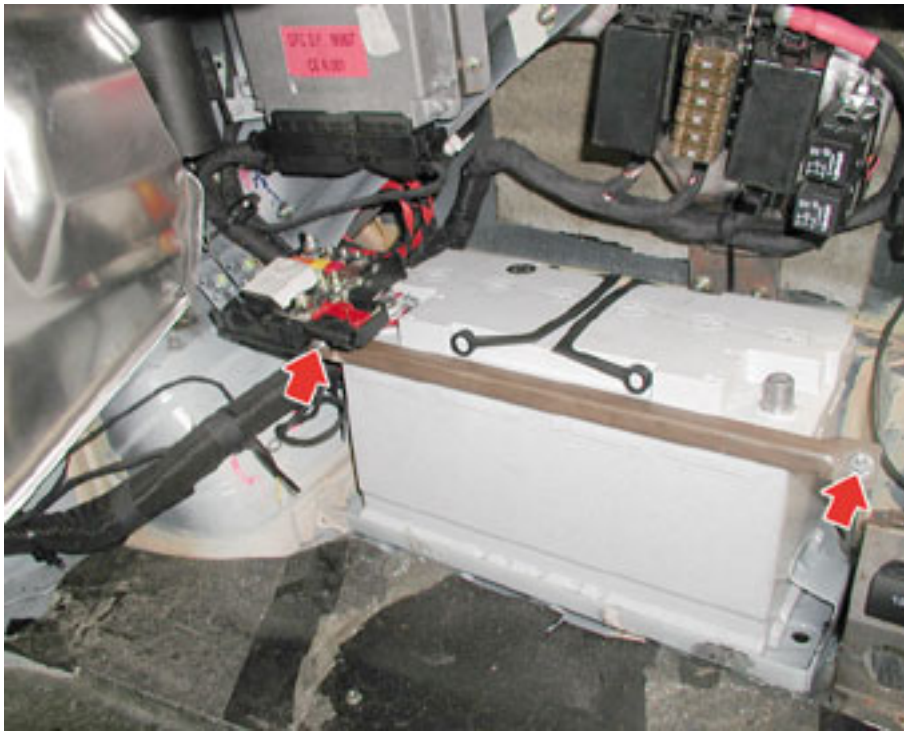

- Disconnect the battery's terminals.



When refitting, follow the above procedures in reverse order

- After connecting the battery's negative terminal the following self-learning operations must be carried out to ensure that certain connected devices recognize the system again:
- Refer to the section:
Component self-learning in the event of battery disconnection

STARTER MOTOR

Removing the starter motor

- Place the car on the hoist.
- Disconnect the battery's negative terminal.
- Lift the car, undo the three fastening screws and remove the starter motor guard.

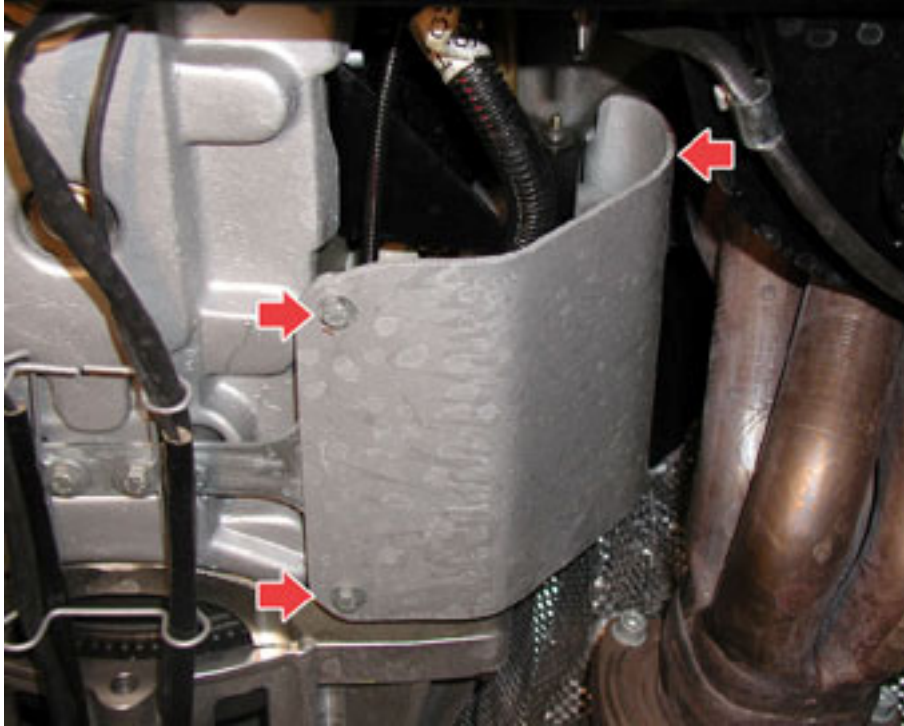

- Lift the rubber guard and unscrew the nut fastening the starter motor power supply cable, then detach the electrical connection.

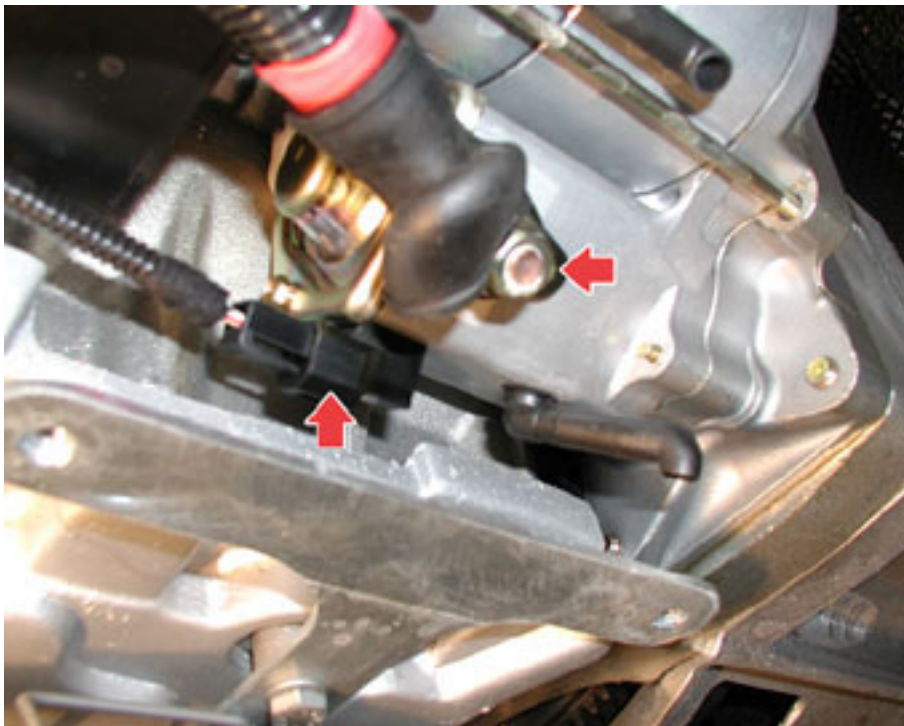

- Undo the screws fastening the starter motor reinforcing bracket.

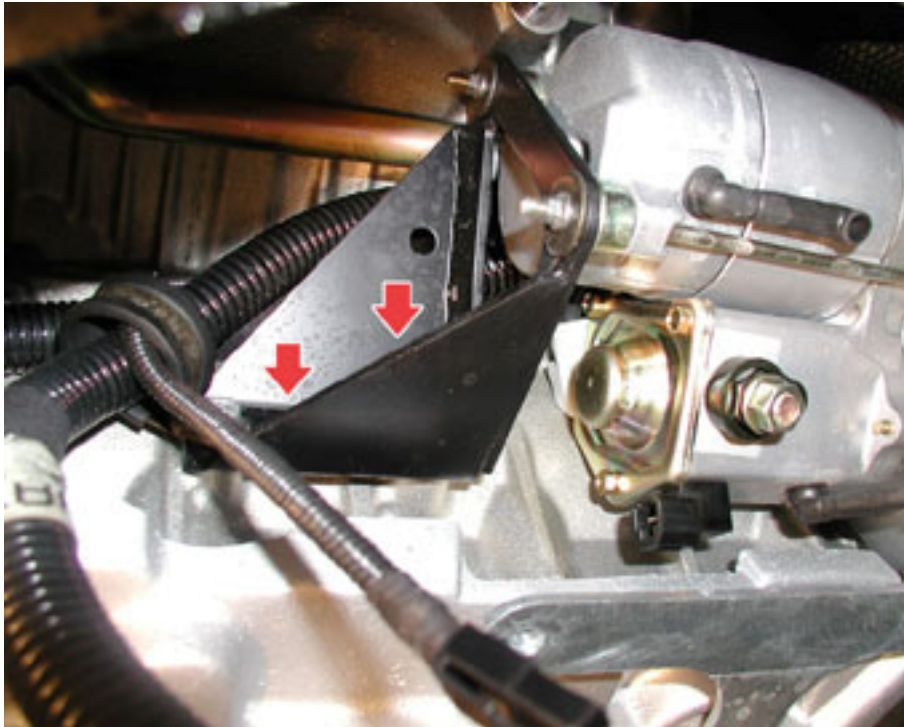

- Undo the three fastening screws on the starter motor.



- Remove the starter motor.



Refitting the starter motor

- Fit the starter motor and tighten the three fastening screws to a torque of **24 Nm**.



- Tighten the two screws fastening the reinforcing bracket to the gearbox to a torque of **7.4 Nm**.



When refitting, follow the remaining procedures in reverse order

- After connecting the negative battery terminal, the following self-learning operations are necessary to ensure certain connected devices acknowledge the system again:
- Refer to section:

Component self-learning in the event of battery disconnection

FUEL TANK

Removing the fuel tank

- Disconnect the battery's negative terminal.
- Remove all the luggage compartment trim panels.

Luggage compartment trim panels

N.B.

Before working on the tank, make sure it is either empty or that there is a small amount of fuel in it. Suck the fuel out of the tank using suitable suction equipment and protections, in compliance with the safety regulations currently in force, DO NOT SMOKE AND DO NOT USE NAKED FLAMES

- Undo the screws and the fastening nuts and remove the protective guard for the fuel tank.

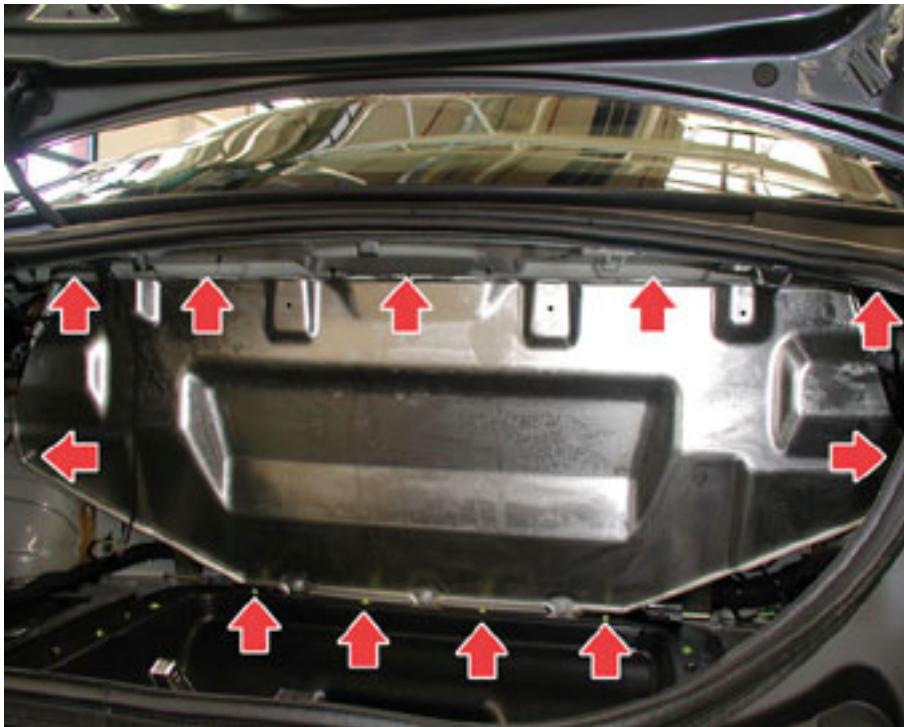

- Detach the quick coupling for the recirculation system from the fuel tank.



- Detach the electrical connection for the fuel tank wiring.



- Undo the screws fastening the tank wiring to the bodywork.



- Open the flap, undo and remove the fuel filler neck cap from its seat.



- Undo the four fastening screws on the filler neck.



- Disconnect the flexible section of the fuel tank filler pipe.



- Undo the screw, disconnect the earth cable, then remove the fuel filler pipe.

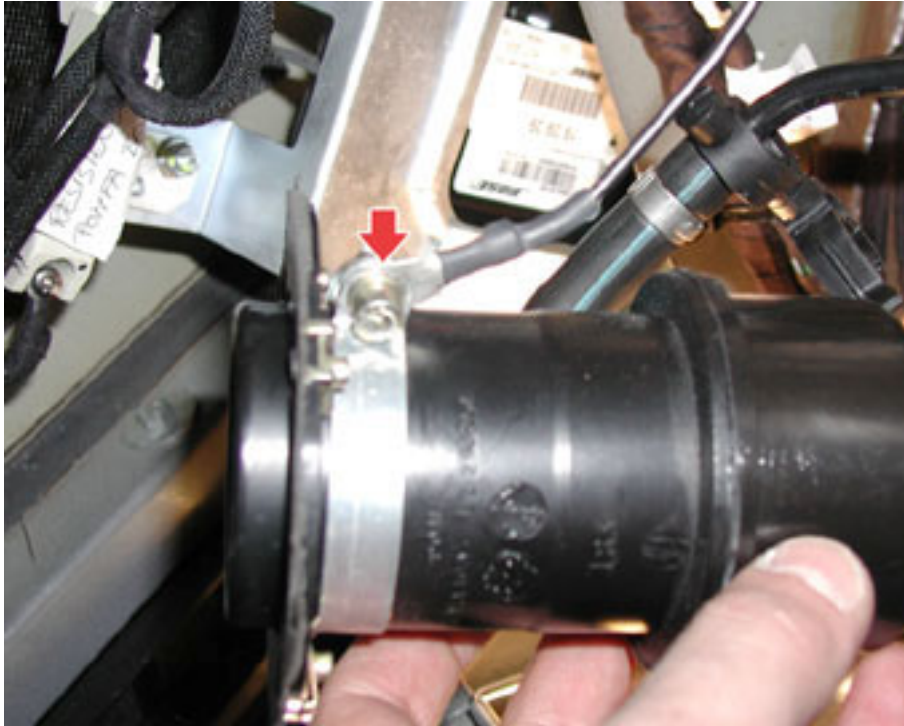

ALL VERSIONS EXCEPT USA- CANADA

- Disconnect the two anti-evaporation system pipes from the active carbon filter.



USA - CANADA VERSION

- Disconnect the connection (1), detach the piping from the quick coupling (2), then undo the screws (3) fastening the diagnosis pump to the fuel tank.



USA - CANADA VERSION

- Lift the anti-evaporation system filter, disengaging the lower rubber couplings (1) from the bodywork, then remove the pump-filter assembly (2).

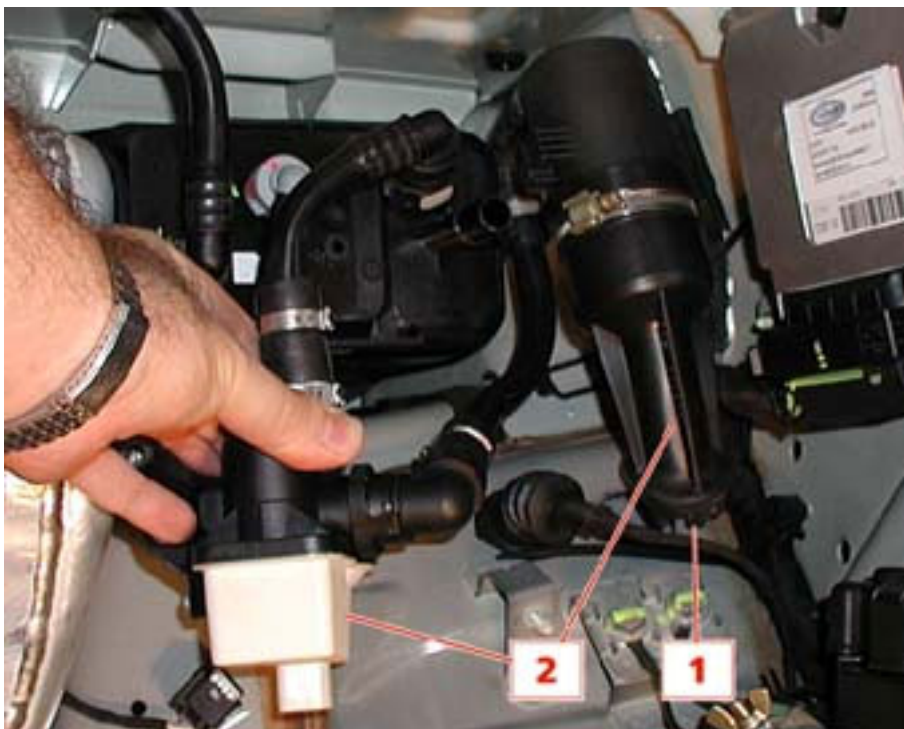

USA - CANADA VERSION

- Detach the quick coupling on the anti-evaporation piping.



ALL VERSIONS

- Undo the two fastening screws on the tank retaining brackets.



- Move the fuel tank backwards and disconnect the breather pipe from the ventilation valve.

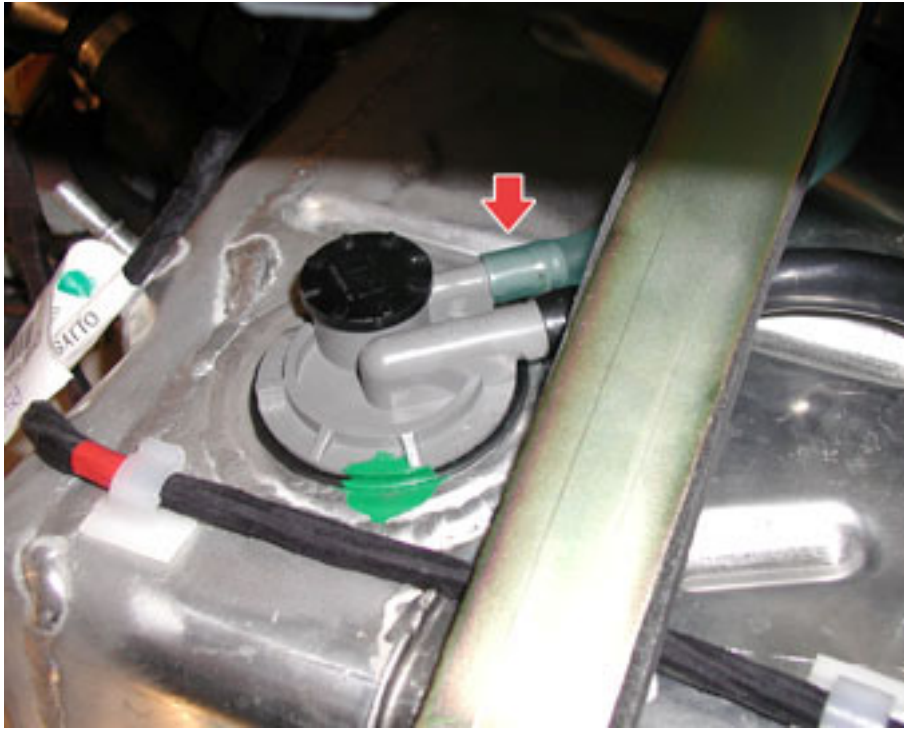

- Disconnect the delivery pipes from both the motor-driven fuel pumps.

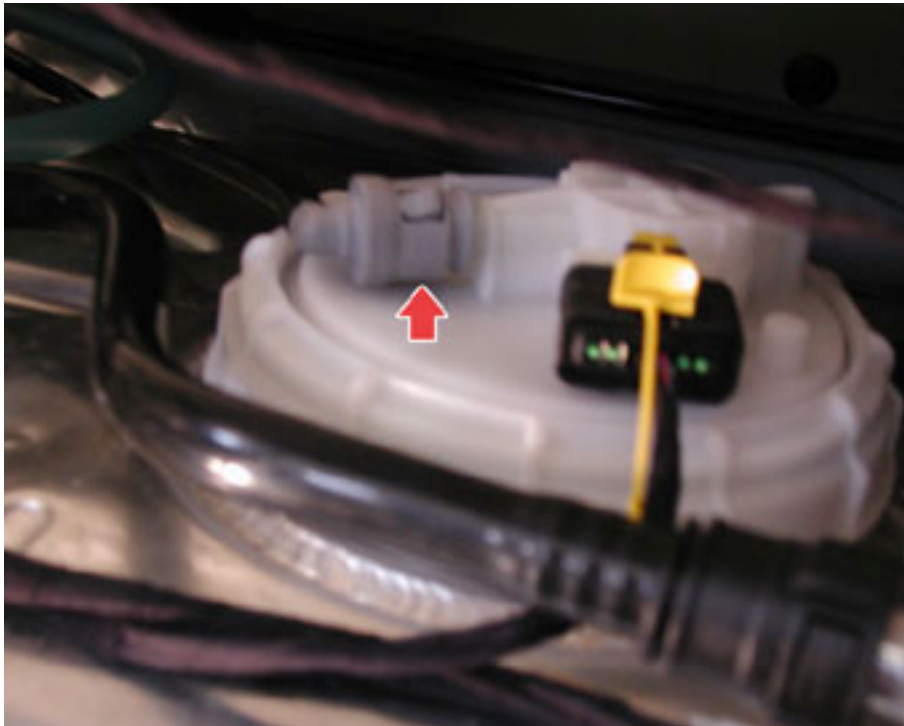

- Remove the fuel tank, taking care not to damage the cable bundle secured to the floor, near the base of the said tank.



Refitting the fuel tank

- If you have to replace the tank, you will need to remove the following components, referring to this service manual for each individual operation.

Motor-driven fuel pump pan assemblies

Anti-evaporation system

- If you refit the tank just removed, clean and wash it out carefully.
- Fit the fuel tank in the luggage compartment and position it in its seat, then connect the two quick couplings on the fuel lines.
- Connect the breather pipe from the ventilation valve.
- Tighten the two fastening screws on the tank retaining brackets to a torque of **12 Nm**.



ALL VERSIONS EXCEPT USA- CANADA

Connect the two anti-evaporation system pipes to the active carbon filter.

USA - CANADA VERSION

- Fit the diagnosis pump, complete with the filter.

ALL VERSIONS

- Fit the fuel filler pipe, connect to the earth cable and tighten the relative screw.
- Undo the screw, disconnect the earth cable, then remove the fuel filler pipe.

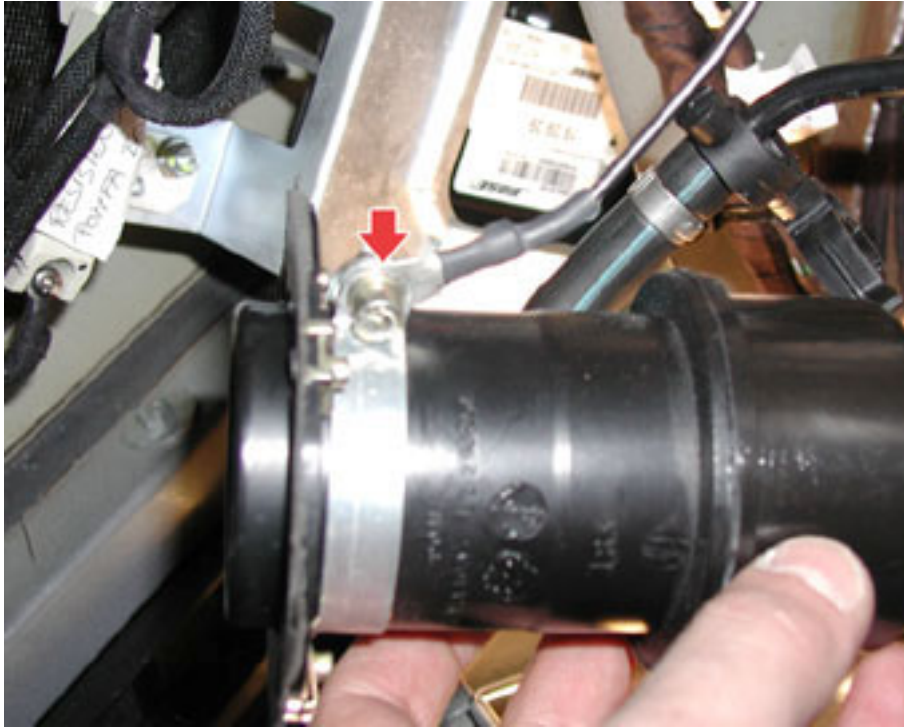

- Connect the flexible section of the fuel filler pipe to the fuel tank.
- Tighten the four fastening screws on the filler neck to a torque of no more than **1.3 Nm**.



- Fit the fuel filler neck cap and close the flap..
- Tighten the screw fastening the tank wiring to the bodywork.
- Attach the fuel tank wiring's electrical connection.
- Connect the quick coupling for the recirculation system to the fuel tank.
- Fit the fuel tank's protective guard and tighten the nuts and the fastening screws to a torque of **7.4 Nm**.

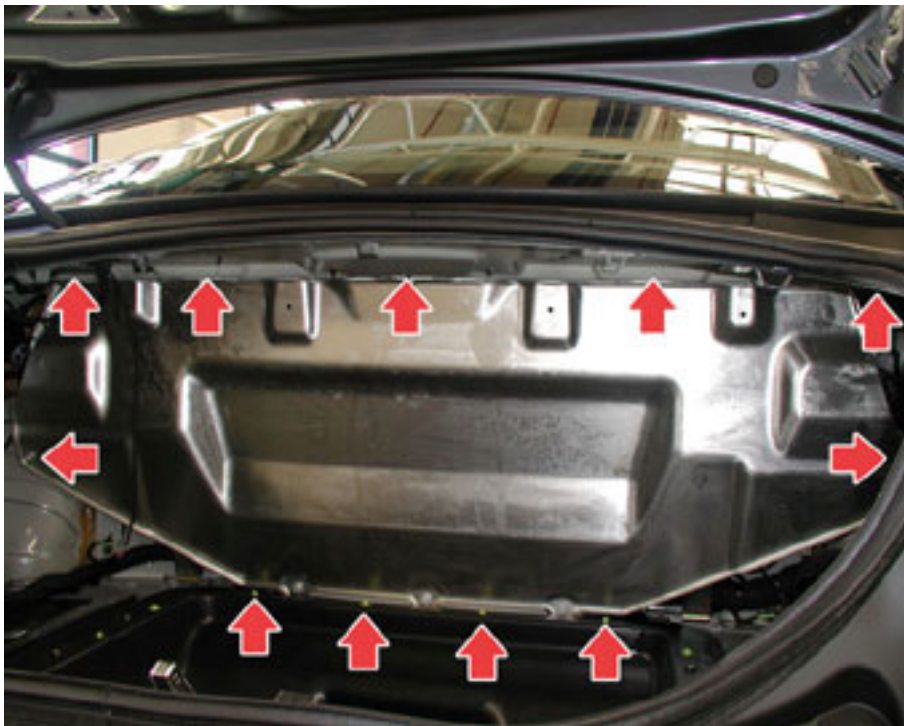

- Carry out all the refitting operations for all the luggage compartment trim panels.

Luggage compartment trim panels

- Disconnect the battery's negative terminal.
- After connecting the negative battery terminal, the following self-learning operations must be carried out to ensure certain connected devices acknowledge the system again:
- Refer to section:

Component self-learning in the event of battery disconnection

MOTOR-DRIVEN PUMP PAN ASSEMBLY

Detaching the motor-driven pump pan assembly

- Remove all the luggage compartment trim panels.
Luggage compartment trim panels
- Remove the fuel tank
Fuel tank
- Detach the electrical connection for the motor driven pump.

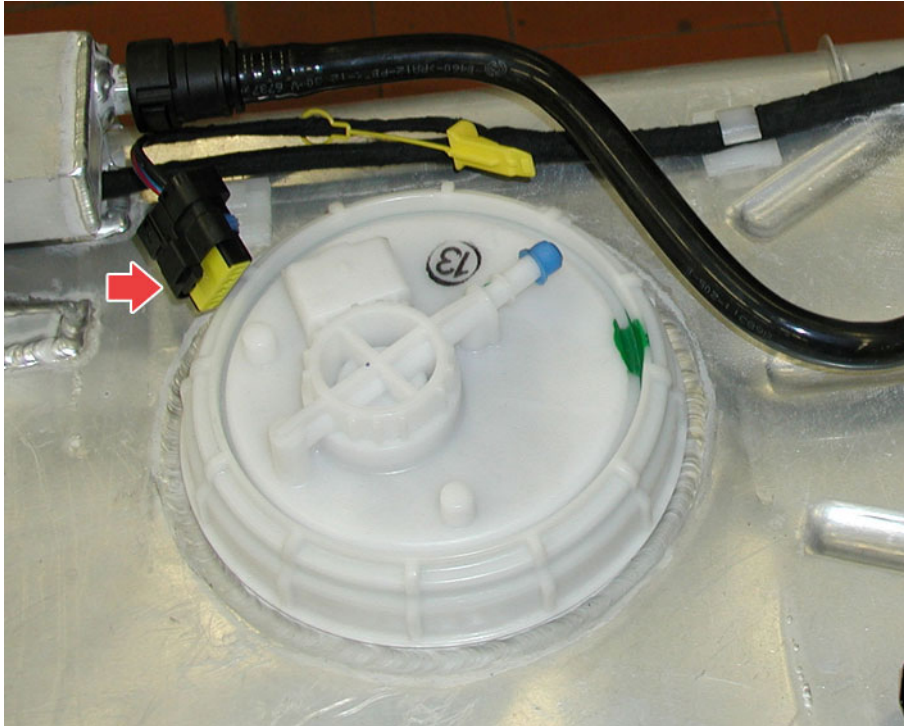

- Using the specific tool **900026390**, undo the locknut and remove the motor-driven pump pan.

N.B.

Carry out the same procedure for the remaining motor-driven pump.



Refitting the motor-driven pump pan assembly

- Fit the motor-driven pump pan assembly, aligning the reference tab on the motor-driven pump with the seat on the tank.
- Tighten the locknut manually and, using tool **900026390**, tighten it to a torque of **60 Nm**.



- Refit the fuel tank

Fuel tank

- Refit all the luggage compartment trim panels.

Luggage compartment trim panels

ANTI-EVAPORATION SYSTEM

Component removal

- Below is an explanation of the removal and refitting operations for the anti-evaporation system components which require the removal of the fuel tank; The following procedure outlines the component removal and refitting operations (specific for the USA-CANADA MARKET) which do not require the removal of the fuel tank.

Fuel tank

- To remove the ventilation valves, proceed as follows.
- Disconnect the quick coupling on the ventilation valve line.



- Rotate the ventilation valve anticlockwise by 90° degrees and remove it from the tank.



- Disconnect the quick coupling on the line connecting the tank with the decanter and unscrew the two nuts fastening the active carbon filter brackets.

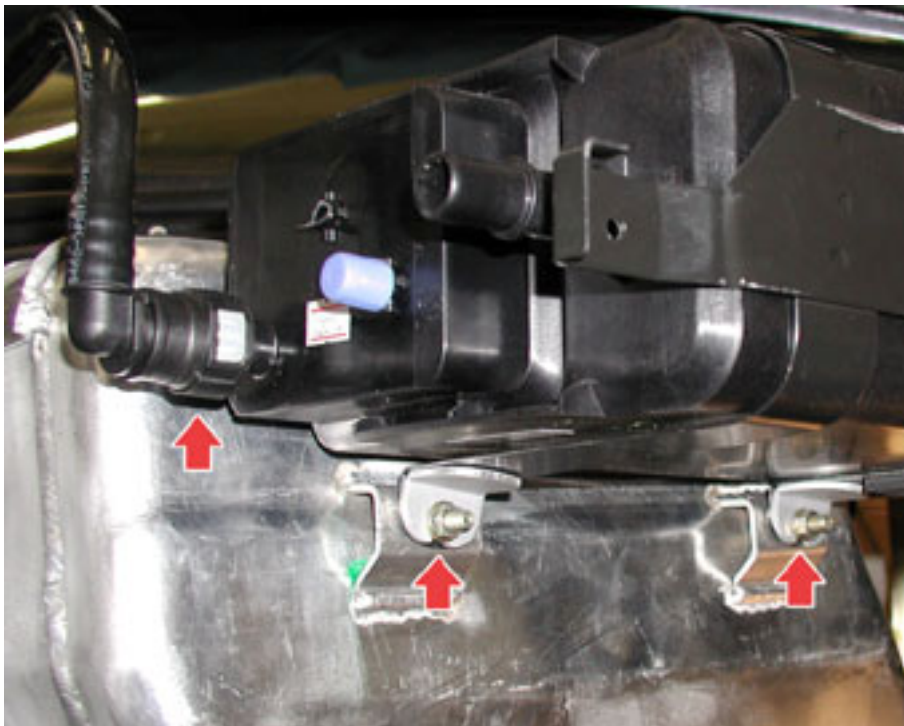

- Release the fastening brackets from the stops on the upper section of the fuel tank.

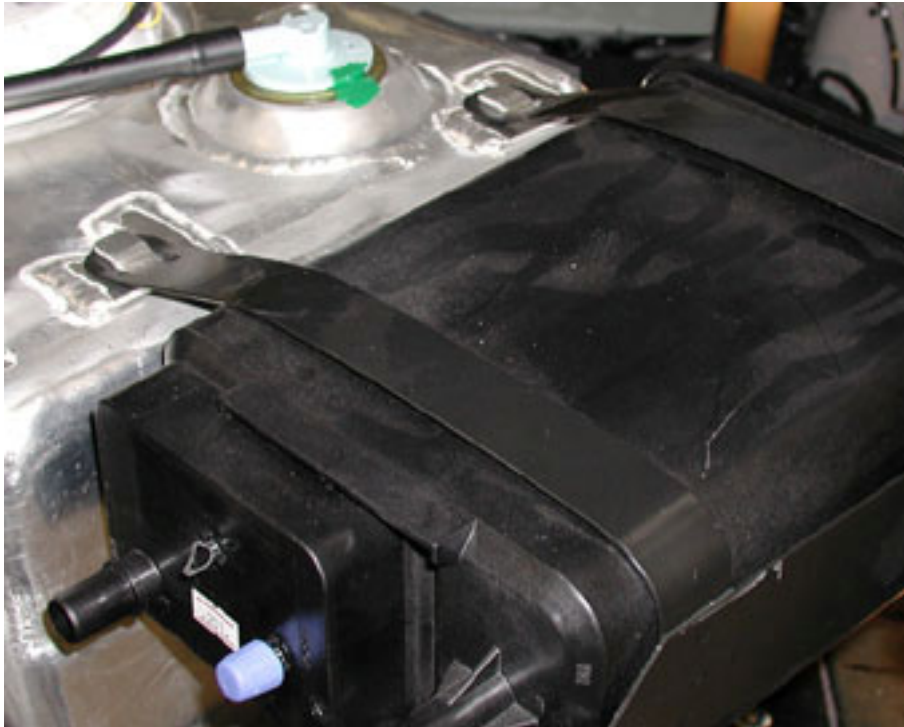

- Remove the active carbon filter.



- To remove the fluid decanter, proceed as follows.
- Disconnect the three quick couplings on the lines, undo the three fastening screws and remove the decanter from the fuel tank.



Component fitting

- To fit the fluid decanter, proceed as follows.
- Fit the decanter, placing the earth cable on the fastening shown, and tighten the three fastening screws.
- Connect the three anti-evaporation system pipes.



- To fit the active carbon filter, proceed as follows.
- Fit the active carbon filter and secure the fastening brackets to the stops on the upper section of the fuel tank.



- Tighten the brackets' fastening nuts to a torque of 8.5 Nm and connect the quick coupling on the line leading to the decanter.

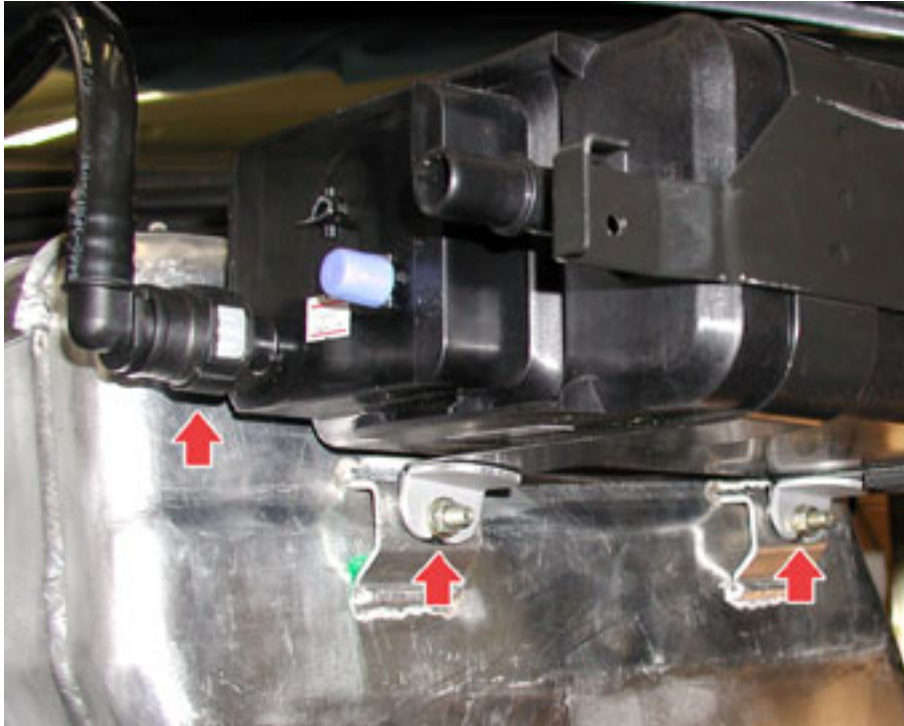

- To fit the ventilation valves, proceed as follows.
- Fit the two ventilation valves in their seat.



- Rotate clockwise by 90° degrees and secure the ventilation valve to the tank.



- Connect the quick coupling for the ventilation valve line to the decanter.



- Refit the fuel tank.
Fuel tank

USA - CANADA VERSION

Removing - refitting the diagnosis pump

- Disconnect the battery's negative terminal.
- Remove all the luggage compartment trim panels.

Luggage compartment trim panels

N.B.

Before working on the tank, make sure it is either empty or that there is a small amount of fuel in it. Suck the fuel out of the tank using suitable suction equipment and protections, in compliance with the safety regulations currently in force, DO NOT SMOKE AND DO NOT USE NAKED FLAMES

- Undo the screws and the fastening nuts and remove the protective guard for the fuel tank.

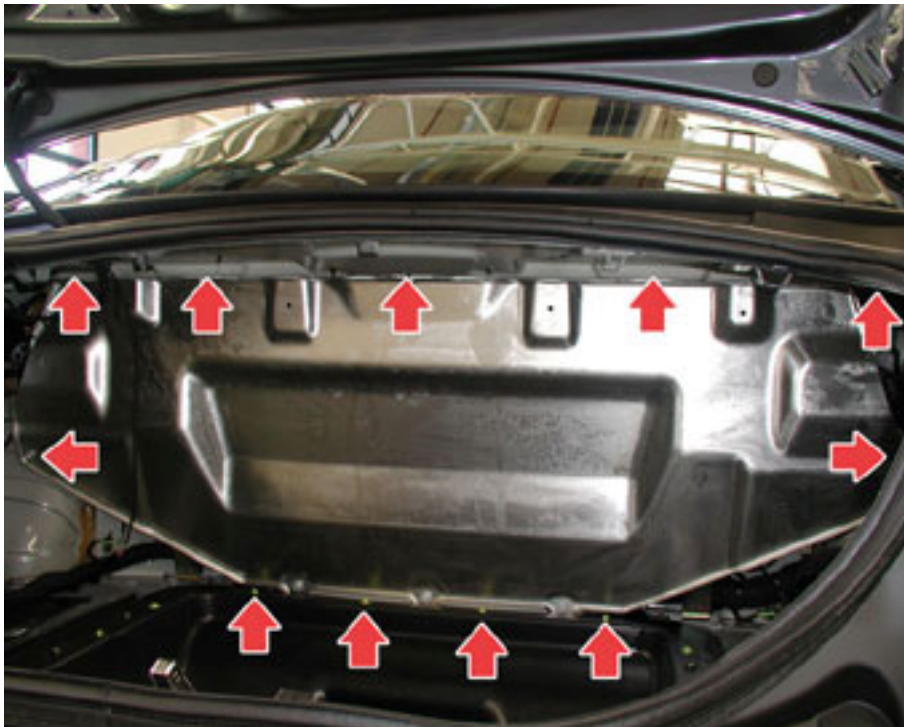

- Detach the connection (1), disconnect the piping from the quick coupling (2), disconnect the piping (3), undo the fastening screws (4) and remove the diagnosis pump.



When refitting, follow the above procedures in reverse order

USA - CANADA VERSION

Diagnosis pump filter replacement

- Disconnect the battery's negative terminal.
- Remove all the luggage compartment trim panels.

Luggage compartment trim panels

N.B.

Before working on the tank, make sure it is either empty or that there is a small amount of fuel in it. Suck the fuel out of the tank using suitable suction equipment and protections, in compliance with the safety regulations currently in force, DO NOT SMOKE AND DO NOT USE NAKED FLAMES

- Undo the screws and the fastening nuts and remove the protective guard for the fuel tank.

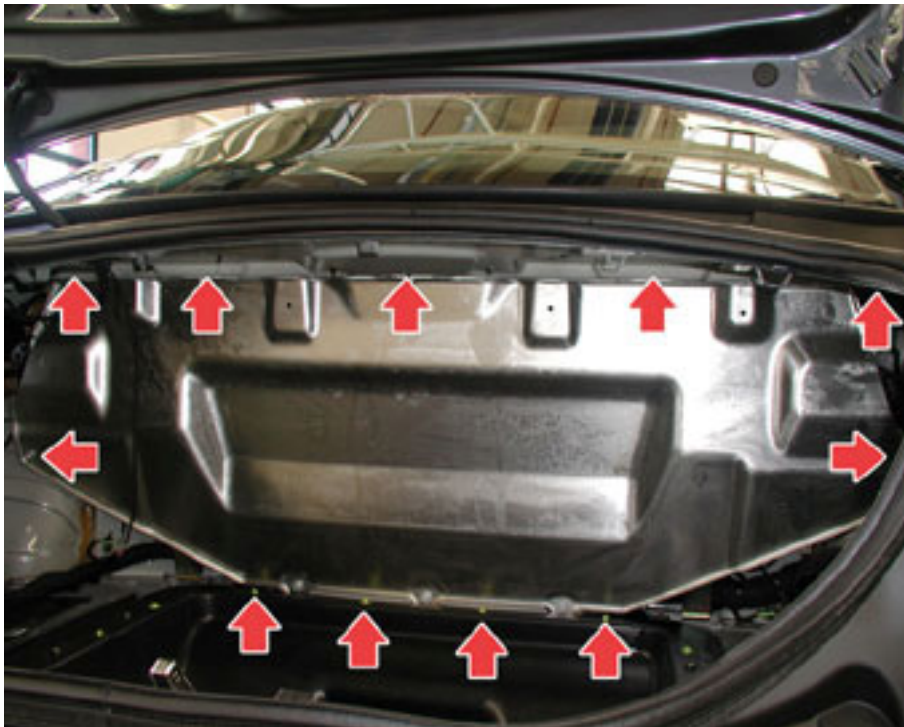

- Lift the anti-evaporation system filter, disengaging the lower rubber couplings (1) from the bodywork, then remove the pump-filter assembly (2).

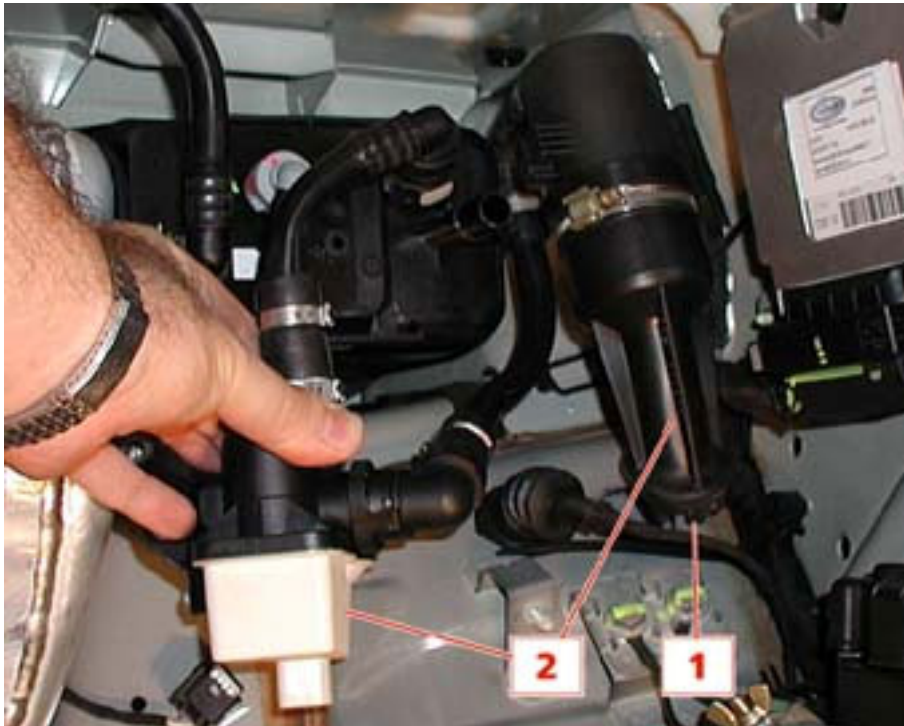

- With the assembly on the bench, disconnect the piping (1) from the filter, open the clamp (2) and remove the diagnosis pump filter (3).



- To ensure the best possible system operation, the diagnosis pump filter must be replaced every 50,000 km.



When refitting, follow the above procedures in reverse order

REPLACING THE ACCELERATOR PEDAL

Removing-refitting the accelerator pedal

- Disconnect the battery's negative terminal.
- Undo the three screws fastening the accelerator pedal to the vehicle's floor.



- Detach the electrical connection on the accelerator pedal potentiometer, then remove the accelerator pedal.



When refitting, follow the above procedures in reverse order

- After connecting the battery's negative terminal the following self-learning operations must be carried out to ensure that certain connected devices recognize the system again:
- Refer to section:

Component self-learning in the event of battery disconnection

SPARK PLUGS

Removing the spark plugs

- Disconnect the battery's negative terminal.
- Remove the trim panels.



- Remove the complete windscreen wiper unit.

Removing-refitting the windscreen wiper unit

- Rotate the plastic screws fastening the engine compartment fuse box cover by 90°, then remove the cover.



- Undo the two fastening screws on the engine compartment fuse box.



- Unscrew the three fastening screws, and remove the engine compartment fuse box mount.



- Undo the two fastening screws on the brake fluid tank.



- Detach the electrical connection.



- Undo the screws fastening the connected devices' pan underneath the windscreen.



- Undo the screws fastening the left-hand connected devices' pan underneath the windscreen and remove the pan.



- Undo the fastening screws and remove the electric wiring cover (operation to be carried out on both cylinder heads)



- Undo the fastening screws on all the ignition coils for the left-hand and right-hand cylinder heads



- Remove the ignition coils.



- Using a specific wrench, remove all the spark plugs.



Refitting the spark plugs

- Using a specific wrench and a torque wrench, tighten all the spark plugs to a torque of **10 Nm**.



- Fit all the ignition coils and tighten the fastening screws to a torque of **10 Nm**.



- Fit the electrical wiring cover, apply Loctite 242 to the screws and tighten them to a torque of **7 Nm**.

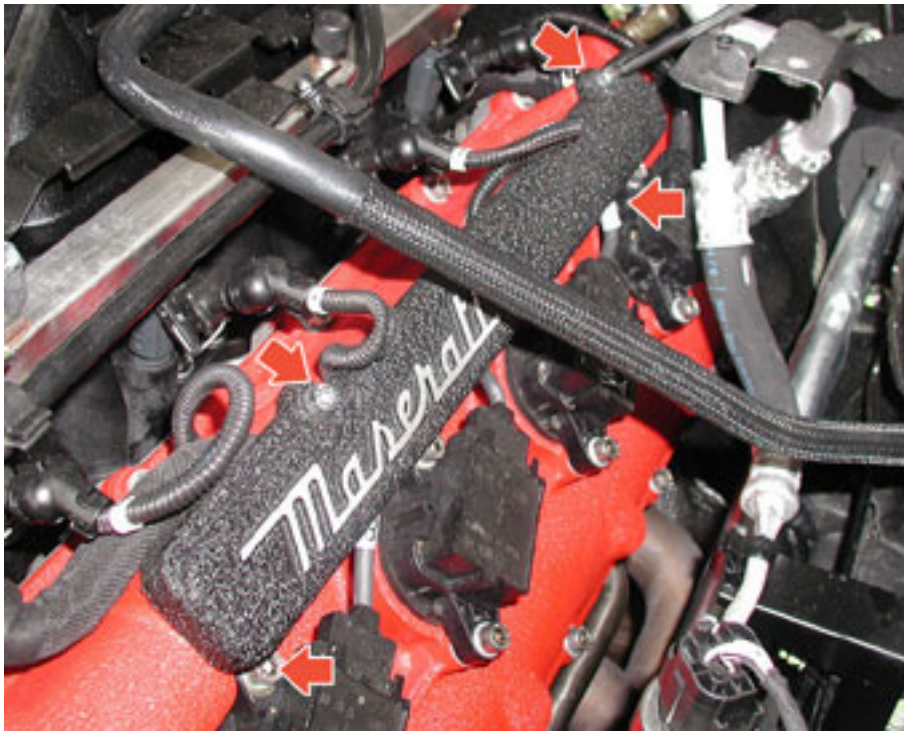

- Fit the connected devices' pan underneath the windscreen and tighten the left-hand fastening screws fully.



- Tighten the screws fastening the right-hand connected devices' pan underneath the windscreen fully.



- Attach the electrical connection.



- Tighten the two fastening screws on the brake fluid tank fully



- Fit the engine compartment fuse box mount and tighten the three fastening screws fully.



- Fit the engine compartment fuse box mount and tighten the three fastening screws fully.



- Fit the fuse box cover and rotate the plastic screws by 90°.



- Fit the complete windscreen wiper unit.
Removing-refitting the windscreen wiper unit
- Fit the engine compartment trim panels.



- After connecting the battery's negative terminal the following self-learning operations must be carried out to ensure that certain connected devices recognize the system again:
- Refer to section:
Component self-learning in the event of battery disconnection

IGNITION COILS

Removing the ignition coils

- Disconnect the battery's negative terminal.
- Remove the trim panels.



- To remove the ignition coils on the right-hand side , proceed as follows:
- Rotate the plastic screws fastening the engine compartment fuse box cover by 90°, then remove the cover.



- Undo the two fastening screws on the engine compartment fuse box.



- Unscrew the three fastening screws, and remove the engine compartment fuse box mount.



- Loosen the clamp screw and remove the water drainage pipe from the trim panel underneath the windscreen.



- Undo the fastening screws on all the right-hand cylinder head's ignition coils, remove them from the spark plugs seats, and undo the fastening screws on the electrical wiring cover and remove it.



- Undo the two screws and the fastening nut on the wiring brackets.



- Detach the four electrical connectors and remove the ignition coils located on the right-hand cylinder head.



- To remove the left-hand ignition coils, proceed as follows:
- Undo the two fastening screws on the brake fluid tank.



- Undo the fastening screws and remove the electrical wiring cover.



- Undo the fastening screws on all the left-hand cylinder head's ignition coils, and remove them from the spark plugs seats.

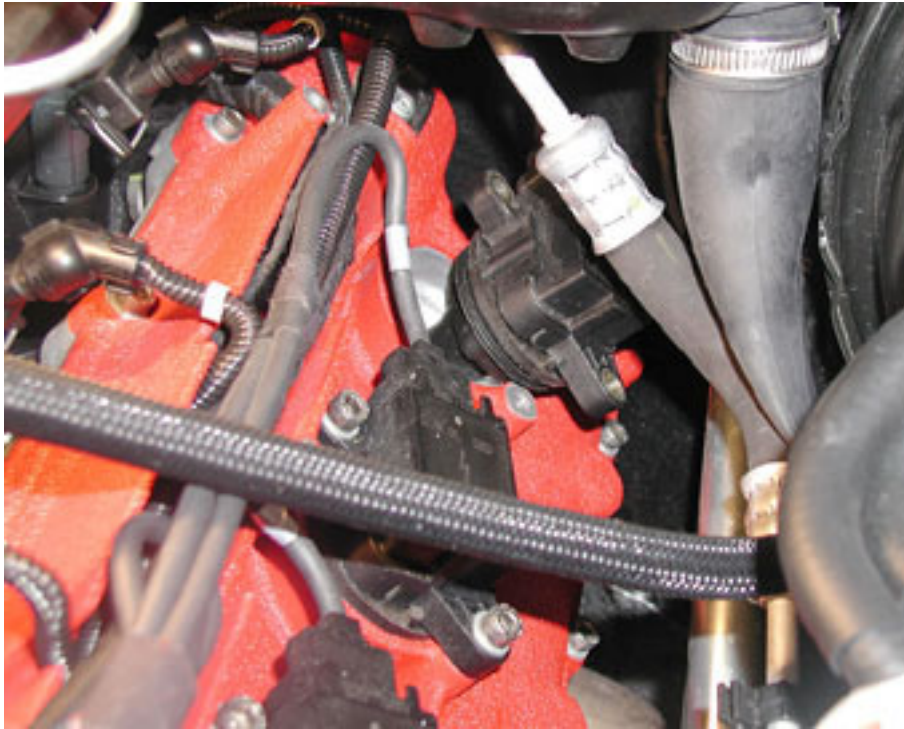

Undo the screws on the two wiring brackets.



- Undo the fastening screw on the wiring bracket, disconnect the four electrical connectors and remove the ignition coils located on the left-hand cylinder head.



Refitting the ignition coils

- To refit the left-hand ignition coils, proceed as follows:
- Fit all the ignition coils and tighten the fastening screws to a torque of 10 Nm.



- Attach the four electrical connectors and tighten the fastening screw on the wiring bracket fully.



- Tighten the fastening screws on the two wiring brackets fully.



- Fit the electrical wiring cover, apply Loctite 242 to the screws and tighten them to a torque of 7 Nm.



- Tighten the two fastening screws on the brake fluid tank fully.



- To fit the left-hand ignition coils, proceed as follows:
- Fit the ignition coils positioned on the right-hand cylinder head and attach the four electric connectors.



- Fit the coils, tighten the fastening screws to a torque of 10 Nm; fit the electric wiring cover, apply Loctite 242 to the screws and tighten them to a torque of 7 Nm.



- Tighten the two fastening screws and the fastening nut on the wiring bracket fully.



- Fit the water drainage pipe from the trim panel underneath the windscreen and secure it by tightening the relative clamp.



- Fit the engine compartment fuse box mount and tighten the three fastening screws fully.



- Fit the engine compartment fuse box mount and tighten the fastening screws fully.



- Fit the fuse box cover and rotate the plastic fastening screws by 90°.



- Fit the engine compartment trim panels.

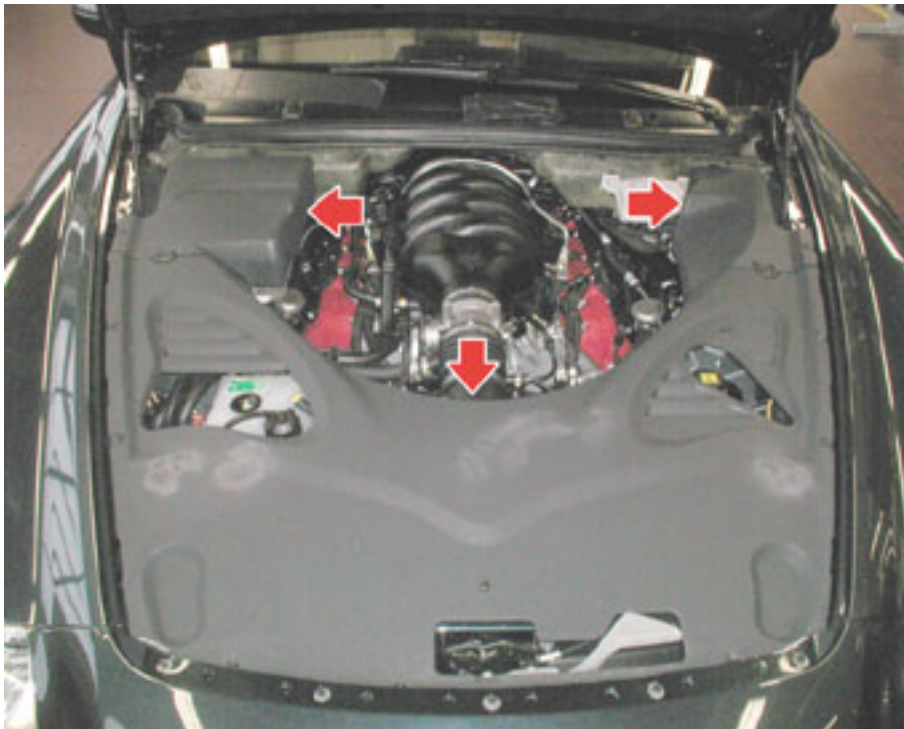

- After connecting the battery's negative terminal the following self-learning operations must be carried out to ensure that certain connected devices recognize the system again:
- Refer to section:
Component self-learning in the event of battery disconnection

ALTERNATOR

Removing the alternator

- Place the vehicle on the hoist.
- Remove the electro-injectors from the engine.

Removing-refitting the electro-injectors

- Remove the belt controlling the engine auxiliary devices.

Removing-refitting the engine auxiliary devices' control belt

- Disconnect the blow-by system line from the right and left-hand cylinder heads.



- Disconnect the anti-evaporation system line from the intake manifold and the coolant recirculation line.



- By means of the tear-clamp, separate the throttle body from the intake manifold.



- Undo the screws fastening the intake manifold to the right-hand cylinder head.



- Undo the screws fastening the intake manifold to the left-hand cylinder head.



- Lift the intake manifold.



- Disconnect the two lines and remove the intake manifold.



- Remove the protection for the alternator power supply cable.

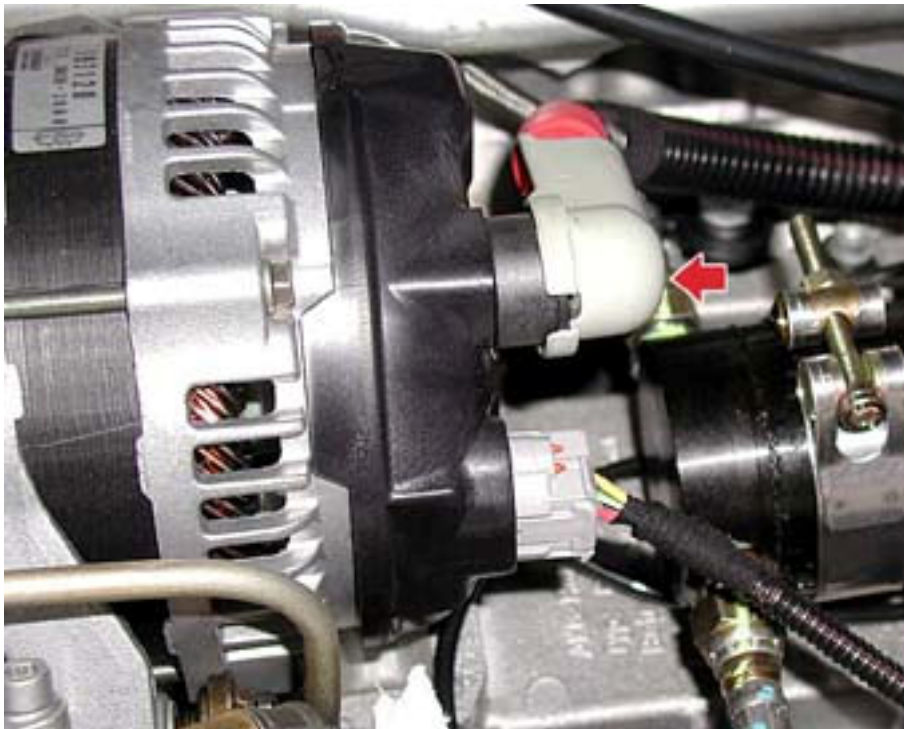

- Unscrew the fastening nut and disconnect the power supply cable, then disconnect the electrical connection.



- Undo the fastening screw on the blow-by line bracket.

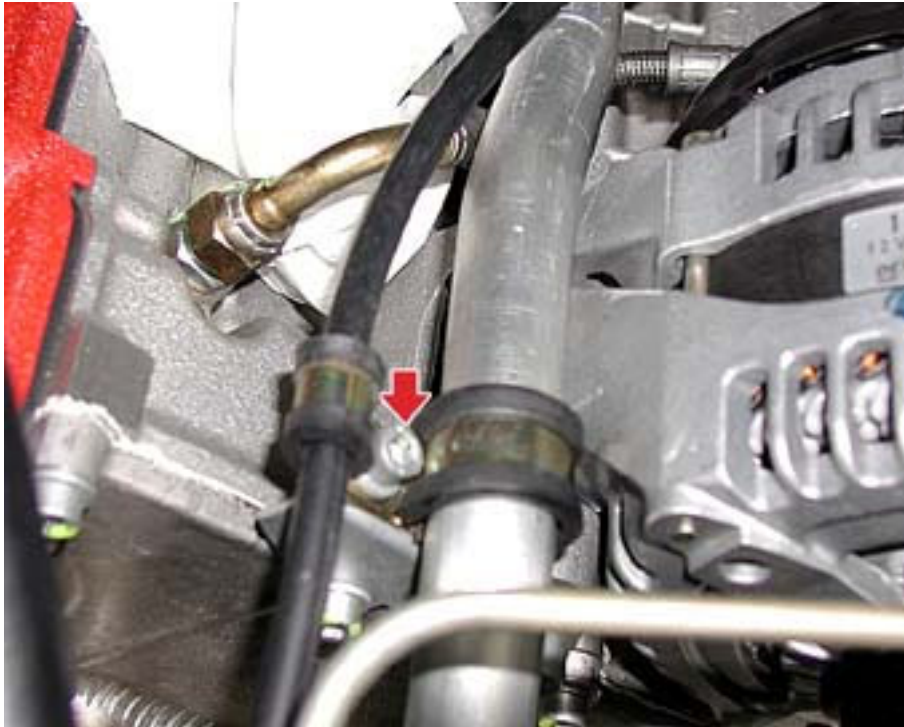

- Undo the two fastening screws on the alternator.



- Loosen the coolant line union on the cylinder head.



- Loosen the fastening nuts on the bracket, and then loosen the left-hand threaded adjusting pin on the alternator.



- Rotate the alternator until it is released from its seat, taking care not to damage the engine coolant's recirculation pipeline and the blow-by pipe, then remove the alternator.



Refitting the alternator

- Fit the alternator in its seat between the two cylinder heads.
- Tighten the fastening nuts on the alternator bracket.
- Tighten the coolant line union on the cylinder head and clean the surrounding area to remove the coolant filtered by the cylinder head.

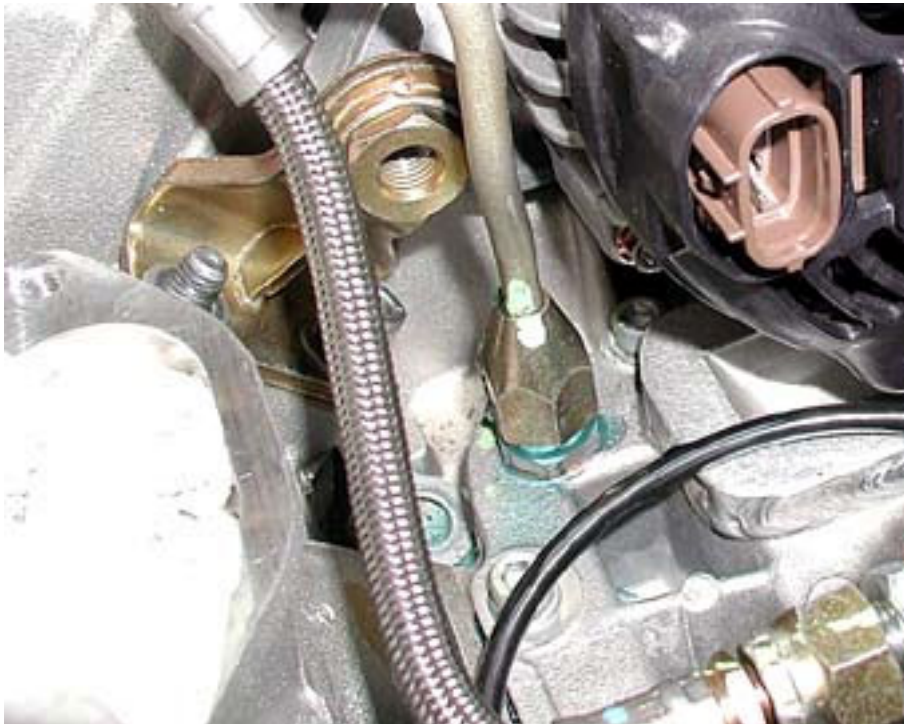

- Check the hole on the alternator and the relative centring pin are aligned, then apply Loctite 242 to the nut threads and tighten them to a torque of **10 Nm**.
- Apply Loctite 242 to the thread on the centring pin and tighten it so that it is flush with the bracket.



- Tighten the fastening screws on the alternator to a torque of **49 Nm**.



- Tighten the fastening screw on the blow-by line bracket.

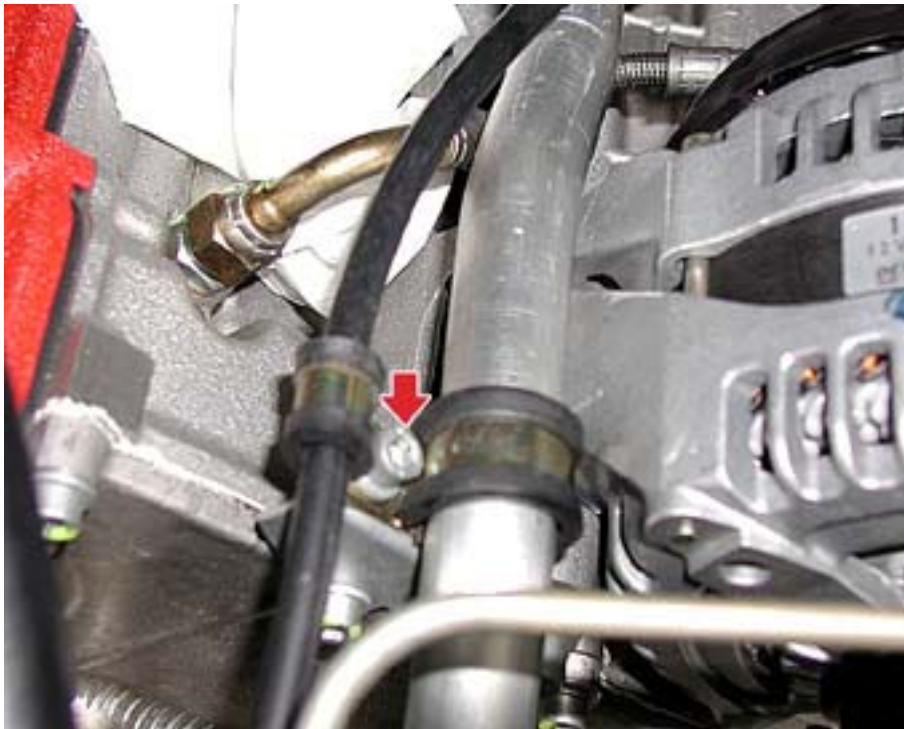

- Connect the power supply cable and secure it with the fastening nut, then attach the electrical connection.
- Position the power supply cable protection guard.



- Check the gaskets on the intake manifold lines are intact. As a rule, they should be replaced every time the manifold is removed.



- Fit the intake manifold and connect the vacuum and recirculation pipes.
- Tighten all the fastening screws on the intake manifold to a torque of **10 Nm**.



When refitting, follow the remaining procedures in reverse order to those outlined for the removal.

- Fit the belt controlling the engine auxiliary devices.
Removing-refitting the engine auxiliary devices' control belt
- Carry out the refitting operation for the electro-injectors.
Removing-refitting the electro-injectors
- Remove the car from the hoist.

ENGINE AUXILIARY DEVICES' CONTROL BELT

Removing-refitting the engine auxiliary devices' control belt

- Place the vehicle on the hoist.
- Remove the floor guard beneath the engine
Removing-refitting the engine floor guard
- Remove the trim guards.



- Detach the electrical connection on the air flow meter and release the two clips from the air filter housing.

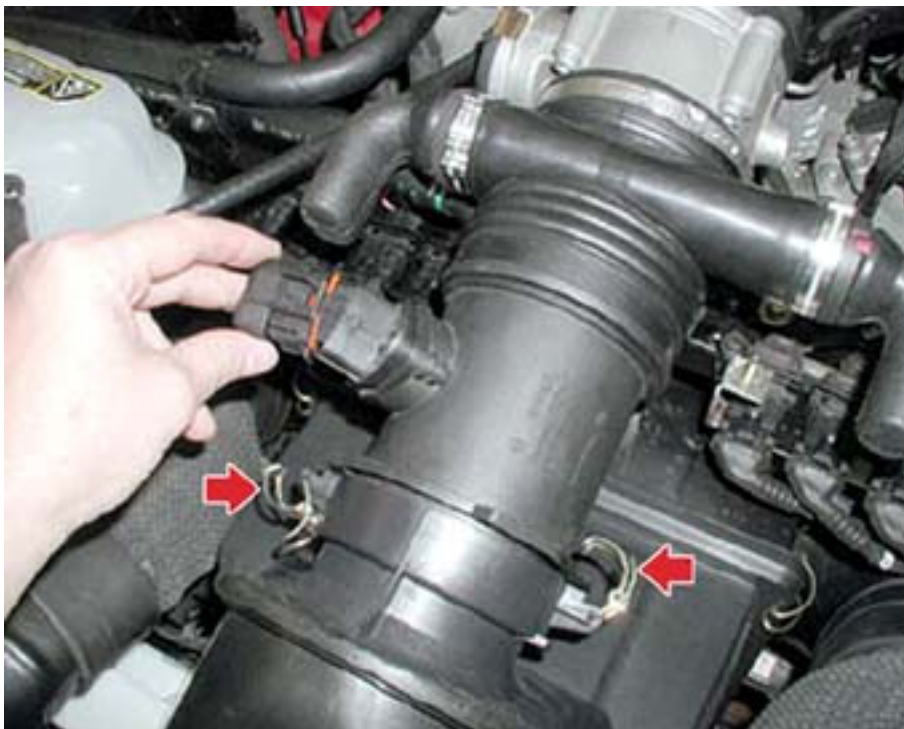

- Remove the air flow meter fastening clamp.



- Remove the air flow meter.



- Remove the two cold air intake lines.



- Release the clips fastening the cover to the air filter housing.



- Remove the cover and take out the air filter.



- Undo the screw fastening the air filter housing to the dome bar.



- Remove the air filter housing.



- Unscrew the two upper nuts on the guard for the engine auxiliary devices' control belt.



- Lift the hoist and unscrew the two lower nuts on the guard for the engine auxiliary devices' control belt .

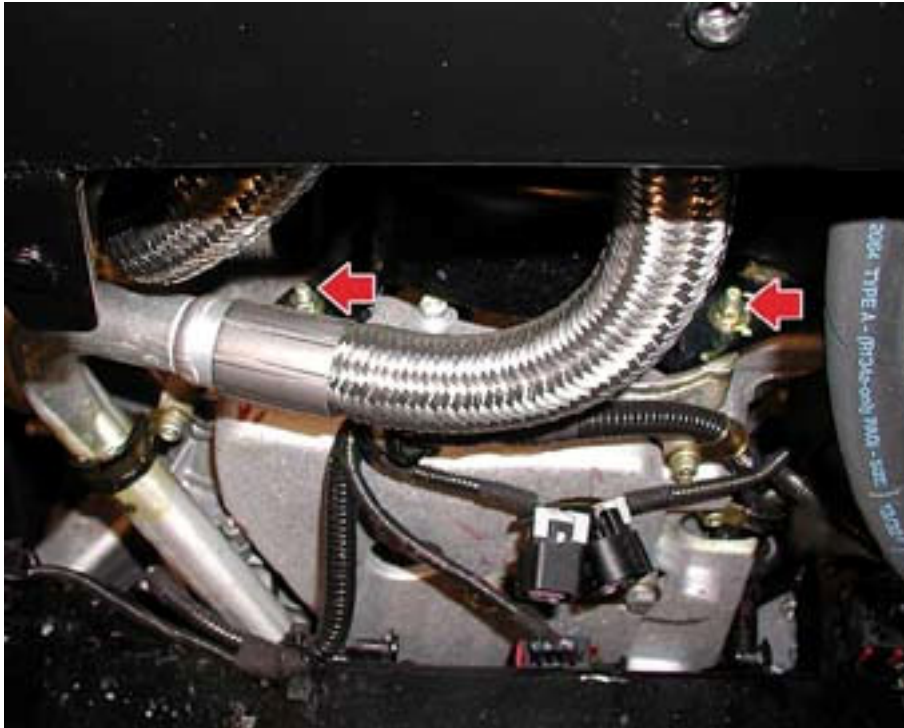

- Lower the hoist and remove the guard for the engine auxiliary devices' control belt.



- Using a wrench, rotate the automatic tensioning device clockwise and remove the engine auxiliary devices' control belt.



Refitting the engine auxiliary devices' control belt

- Fit the engine auxiliary devices' control belt onto the pulleys, then rotate the automatic tensioning device anticlockwise, insert the belt underneath the device's pulley and release the device slowly.



N.B.

The tensioning device is automatic and, by means of a preloaded spring, it is capable of tensioning the belt correctly during its fitting and of automatically recovering the slack created during standard operation. No tension check is therefore necessary.

CAUTION

Do not let the belt come into contact with oil or solvents that could alter the elasticity of its rubber material, with a consequent reduction in grip potential. Also check that there are no cracks or cuts on the belt and, if any are found, replace the belt.

When refitting, follow the remaining procedures in reverse order and, in addition, clean the air flow meter and the filter housing thoroughly to prevent the infiltration of impurities which could impair the operation of the air flow meter's sensor.

INTAKE MANIFOLD

Removing the intake manifold

- Place the vehicle on the hoist.
- Remove the electro-injectors from the engine.

Removing-refitting the electro-injectors

- Disconnect the blow-by system line from the right and left-hand cylinder heads.



- Disconnect the anti-evaporation system line from the intake manifold and the coolant recirculation line.



- By means of the tear-clamp, separate the throttle body from the intake manifold.



- Undo the screws fastening the intake manifold to the right-hand cylinder head.



Undo the screws fastening the intake manifold to the left-hand cylinder head.



- Lift the intake manifold.



- Disconnect the two lines and remove the intake manifold.



Refitting the intake manifold

- Check the gaskets on the intake manifold lines are intact. As a rule, they should be replaced every time the manifold is removed.



- Fit the intake manifold and connect the vacuum and recirculation pipes.
- Tighten all the fastening screws on the intake manifold to a torque of **10 Nm**.



When refitting, follow the remaining procedures in reverse order to those outlined for the removal.

- Refit the electro-injectors.
- Removing-refitting the electro-injectors*
- Remove the vehicle from the hoist.

EXHAUST MANIFOLDS

Detaching the exhaust manifolds

- Place the vehicle on the hoist.

IMPORTANT

The procedure outlined here is followed by the procedure for the removal of the exhaust manifolds for the USA-CANADA version.

- Remove the floor guard beneath the engine.

Engine floor guard

- Remove the exhaust tailpipes.

Removing-refitting the tailpipe

- Unscrew the two rear Lambda sensors on the catalytic converters and release the cables from the central fastening bracket.

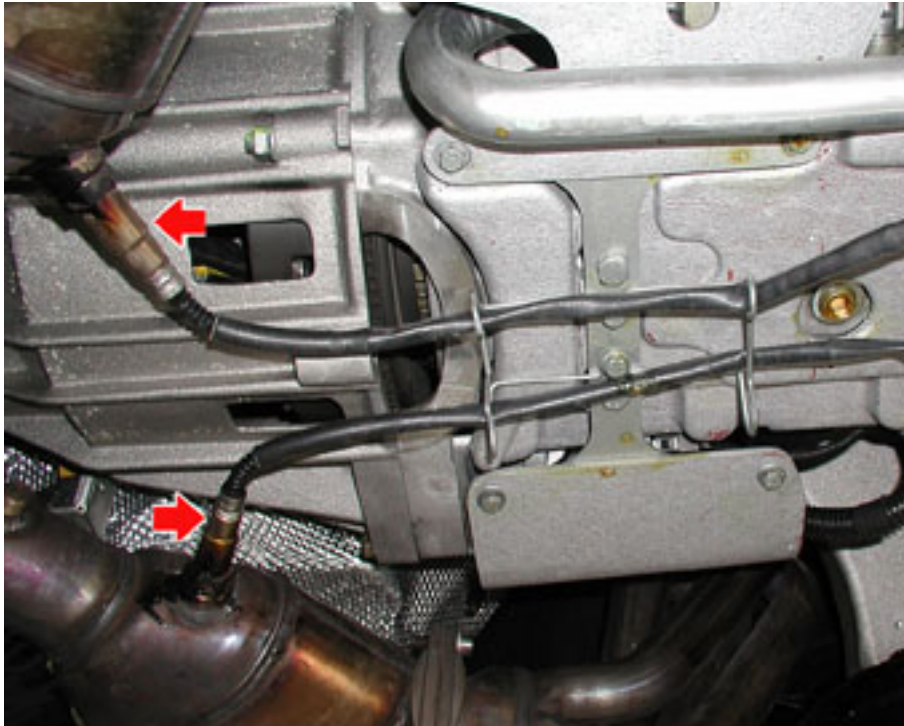

- Undo the wiring fastening screws, then unscrew the Lambda sensor from the left-hand catalytic converter.

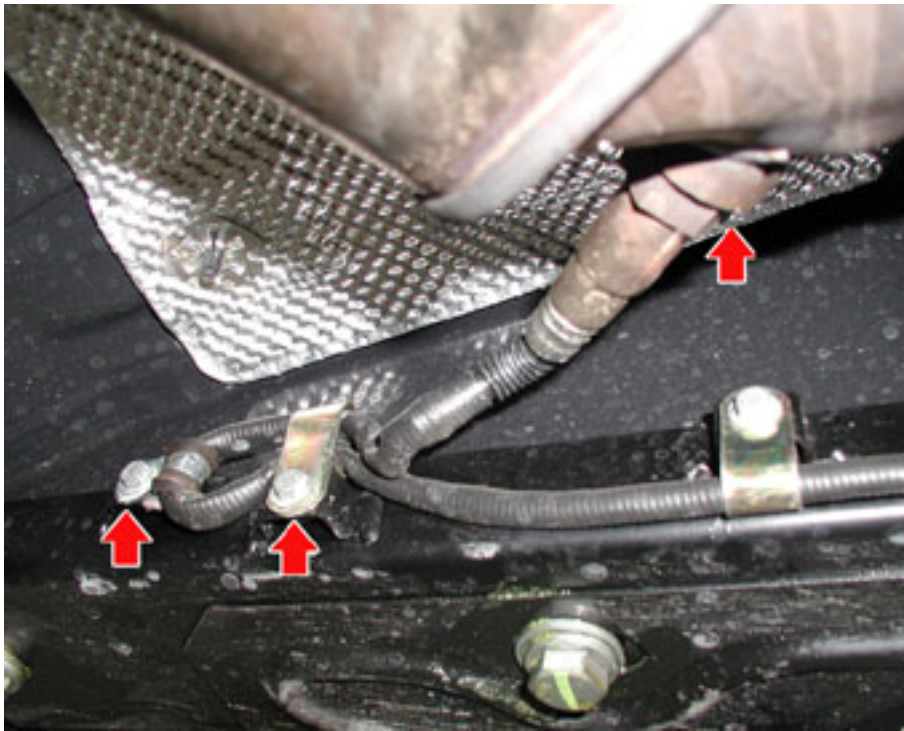

- Undo the wiring fastening screws, then unscrew the Lambda sensor from the right-hand catalytic converter.

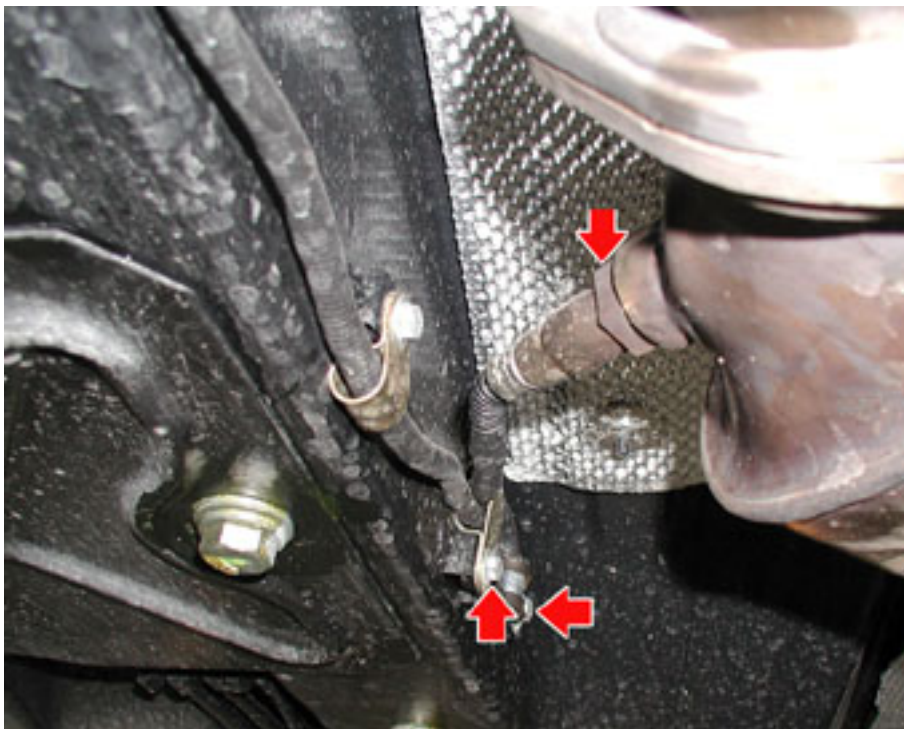

- Unscrew the fastening nuts on the central catalytic converter mount.

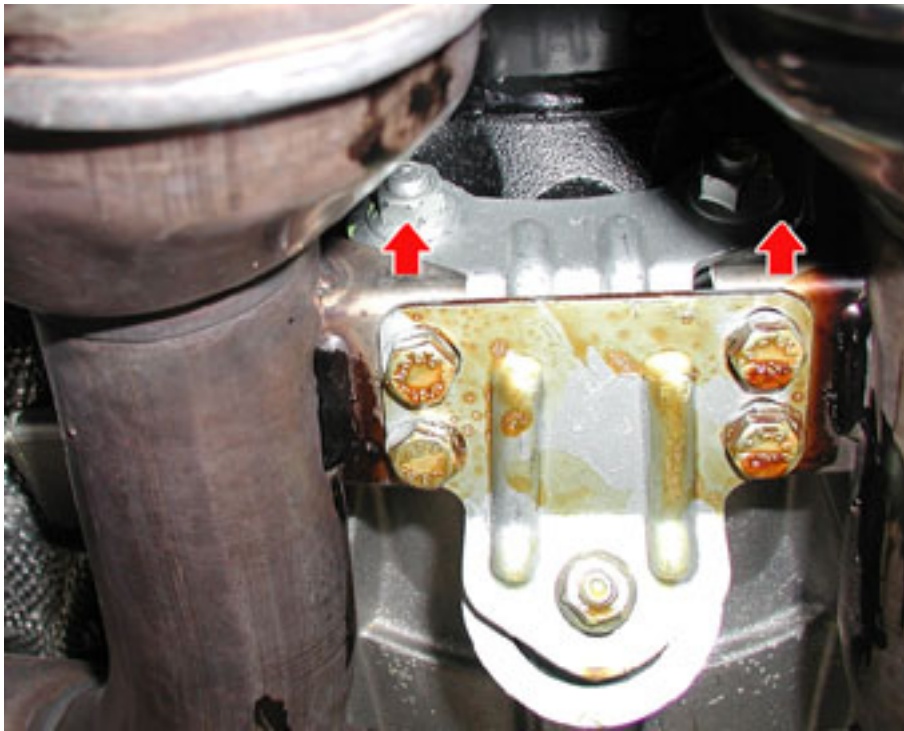

- Unscrew the six screws fastening the catalytic converter to the relative manifolds.

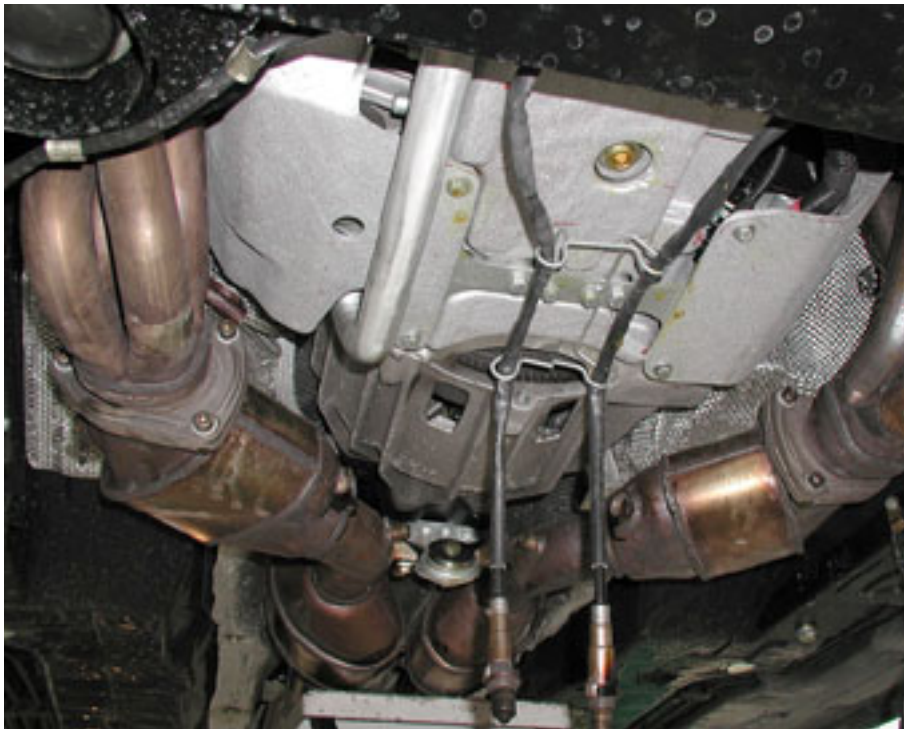

- Position a hydraulic support beneath the catalytic converter/ central exhaust silencer assembly, lower it slowly, then remove the catalytic converters together with the central exhaust silencers.
- Retrieve the catalytic converter conductive gaskets.



- Remove the trim guards.



- Disconnect the air hose from the rigid line.

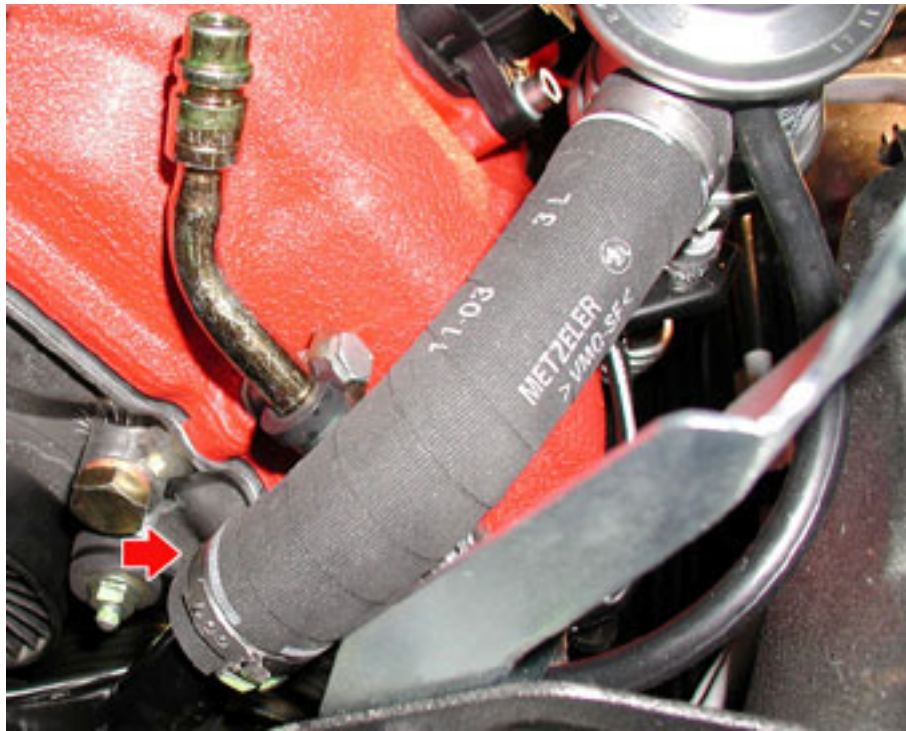

- Disconnect the vacuum pipe from the valve.

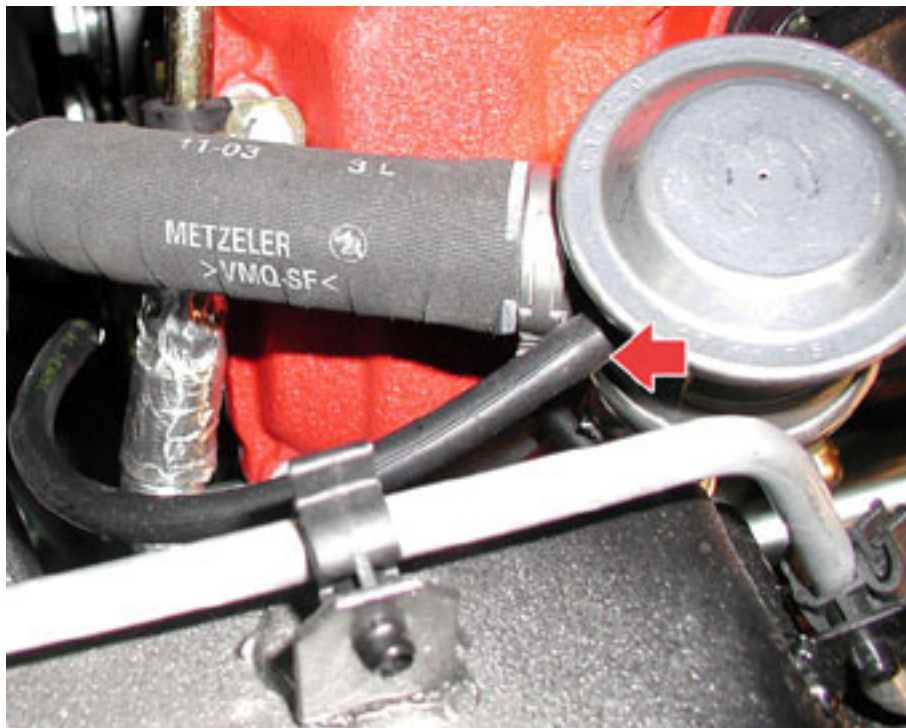

- Undo the front fastening screw on the valve supporting bracket.



- Undo the rear fastening screw on the valve supporting bracket.

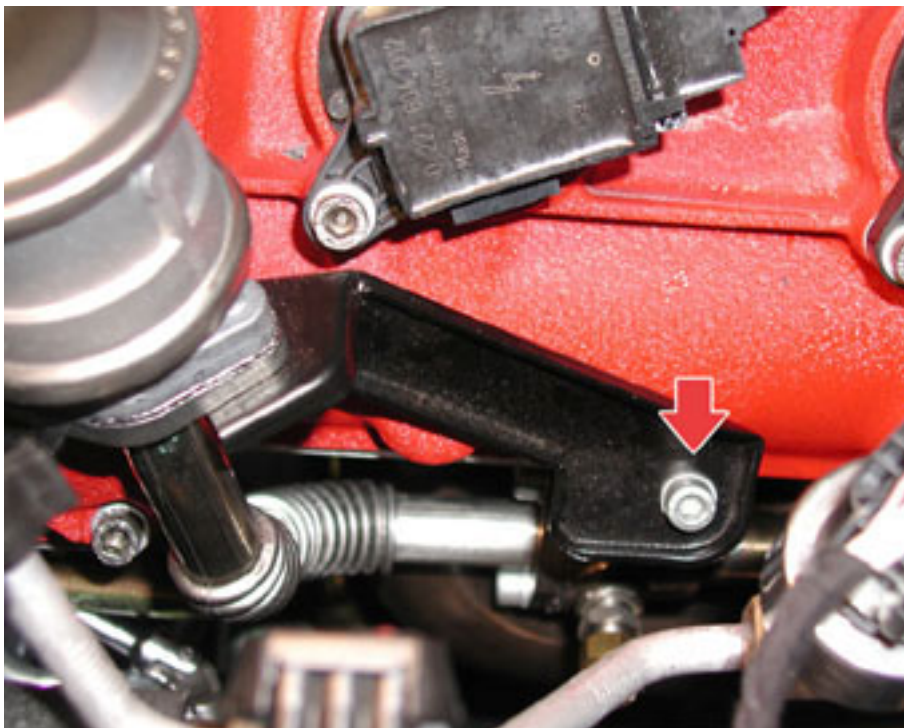

- Unscrew and remove the complete union, unscrewing it from the rigid line.

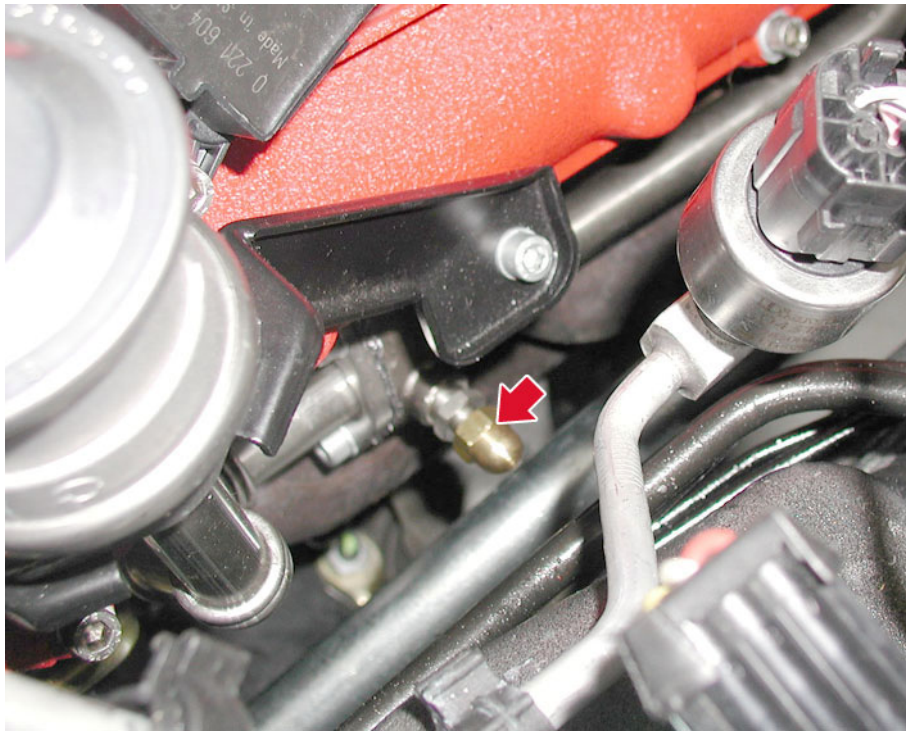

- Lift the hoist and undo the fastening screws, then remove the starter motor's metal guard.



Undo the screw fastening the steering column to the box, then separate them.



- Unscrew the nuts fastening the exhaust manifold to the cylinder head.



- View of the points at which the exhaust manifold is fastened to the cylinder head.



- Release the manifold from the stud bolts and remove it, taking care not to damage the secondary air system's pneumatic valve.
- Retrieve the exhaust manifold gasket.



N.B.

This procedure also applies to the other exhaust manifold, provided that you remember to remove the engine compartment fuse box and relative mount before working on the manifold.

Refitting the exhaust manifolds

- Fit the new gasket, fit the exhaust manifold complete with the pneumatic valve and tighten the fastening nuts to a torque of **25 Nm**.



- Tighten the screw fastening the steering column and steering box to a torque of **25 Nm**.



- Fit the metal guard on the starter motor and tighten the three fastening screws.
- Tighten the whole union on the rigid line.
- Tighten the screws fastening the pneumatic valve mounting bracket to the cylinder head.
- Connect the air vacuum pipe to the valve and to the rigid line.
- Fit the trim guards.
- Using a hydraulic support positioned underneath the catalytic converter/central exhaust silencer assembly, position the catalytic converters in their seat together with the central exhaust silencers.

N.B.

Visually inspect that the gasket located underneath the flange joining the catalytic converter and the exhaust manifold is intact and if signs of wear are found, replace it.

N.B.

The conductive gaskets must never be fitted more than once. The second time the component is fitted, they must be replaced

- Fit the conductive gaskets.



- Tighten the screws fastening the exhaust manifold to the catalytic converter to a torque of **25 Nm**.

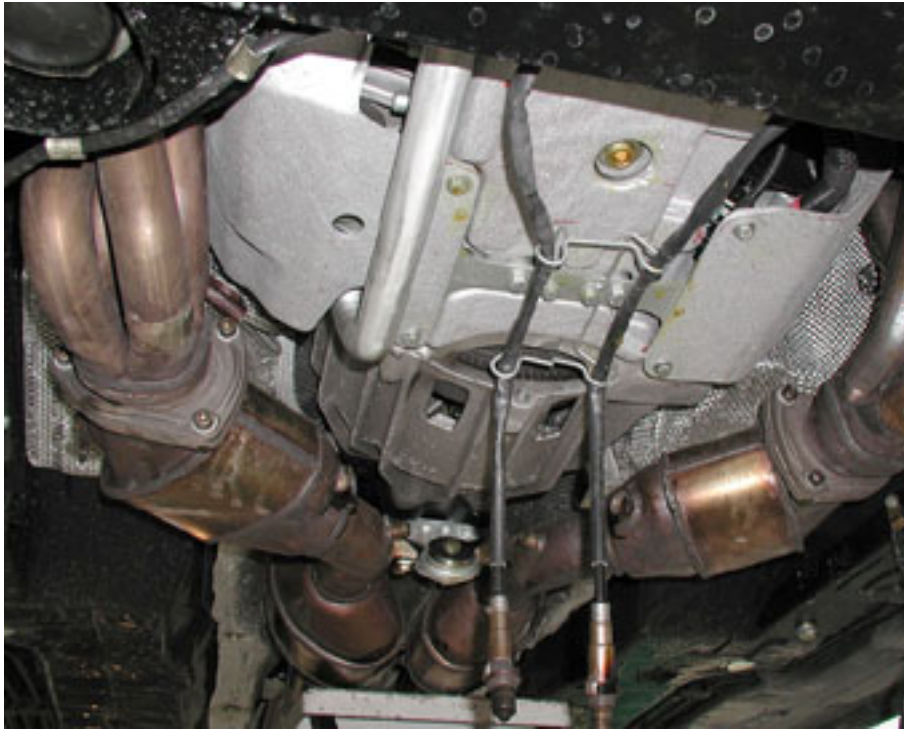

- Tighten the fastening nuts on the central catalytic converter mount.

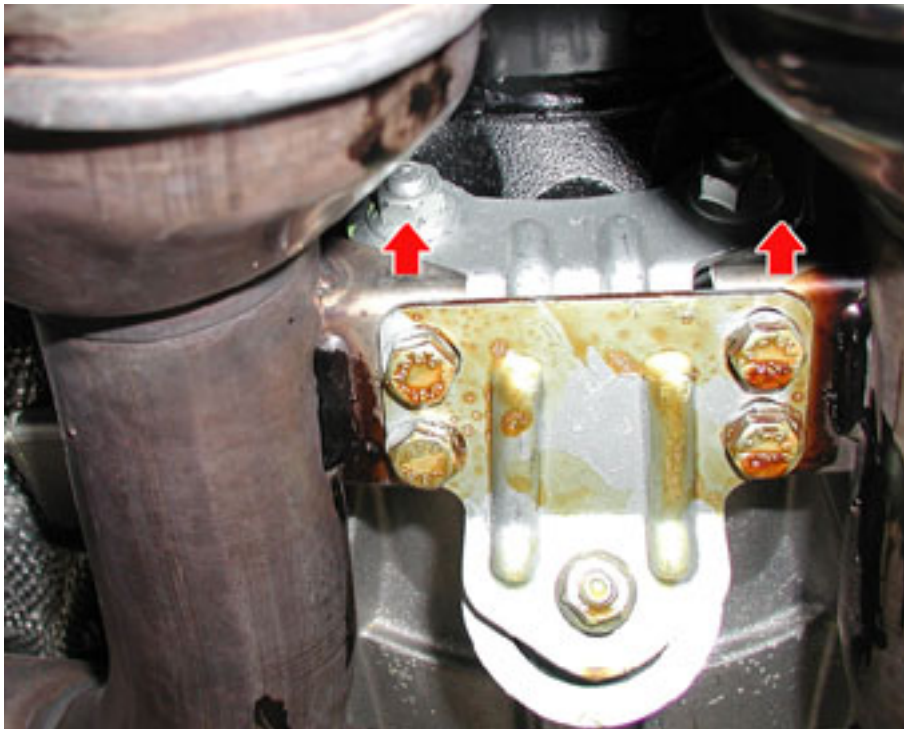

- Fit all the Lambda sensors, then tighten them to a torque of **50 Nm**.
- Suitably secure the front Lambda sensor wiring to the engine frame.

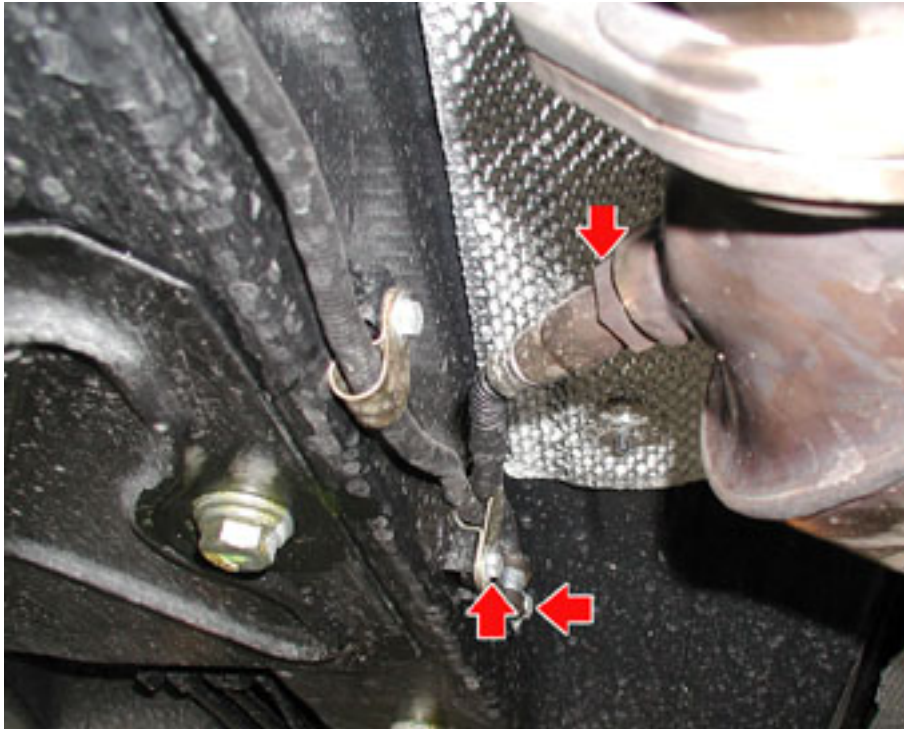

- Proceed by refitting the exhaust tailpipes.
Removing-refitting the tailpipe
- Remove the floor guard beneath the engine.
Engine floor guard

Detaching the exhaust manifolds

IMPORTANT

The procedure below illustrates how to remove the catalytic converters for the USA–CANADA version.

- **USA - CANADA VERSION**

- Place the vehicle on the hoist.
- Remove the exhaust tailpipes.

Tailpipe

- Remove the two exhaust extensions.

Exhaust extension pipe

- Remove the central exhaust silencer.

Exhaust silencer

- Remove the floor guard beneath the engine.

Engine floor guard

- Remove both catalytic converters.

Catalytic converters

- Unscrew and remove the union **(1)**, undo the two screws **(2)** and separate the rigid secondary air piping.

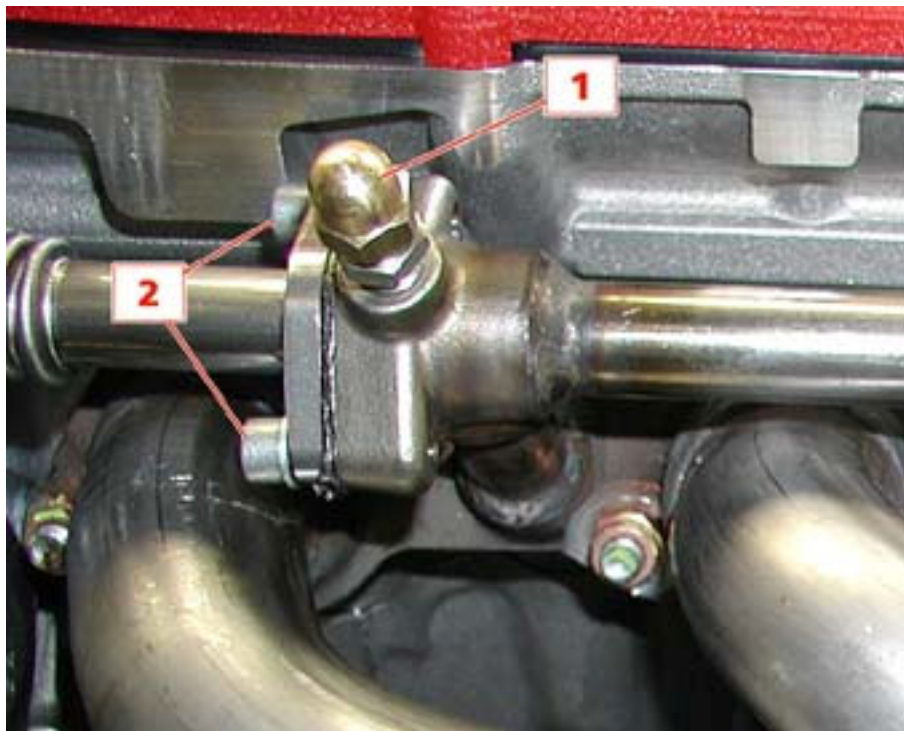

- Undo the screw fastening the steering column to the box, then separate them.



- Working from the top, for the RH manifold, using a ratchet connected to an **USAG 236 3/8 TS** type extension with a length of **75mm** or a **BETA 910 AN/75** extension, unscrew the two fastening nuts indicated.
- Using the same wrenches, lift the hoist and unscrew the same fastening nuts on the LH manifold.

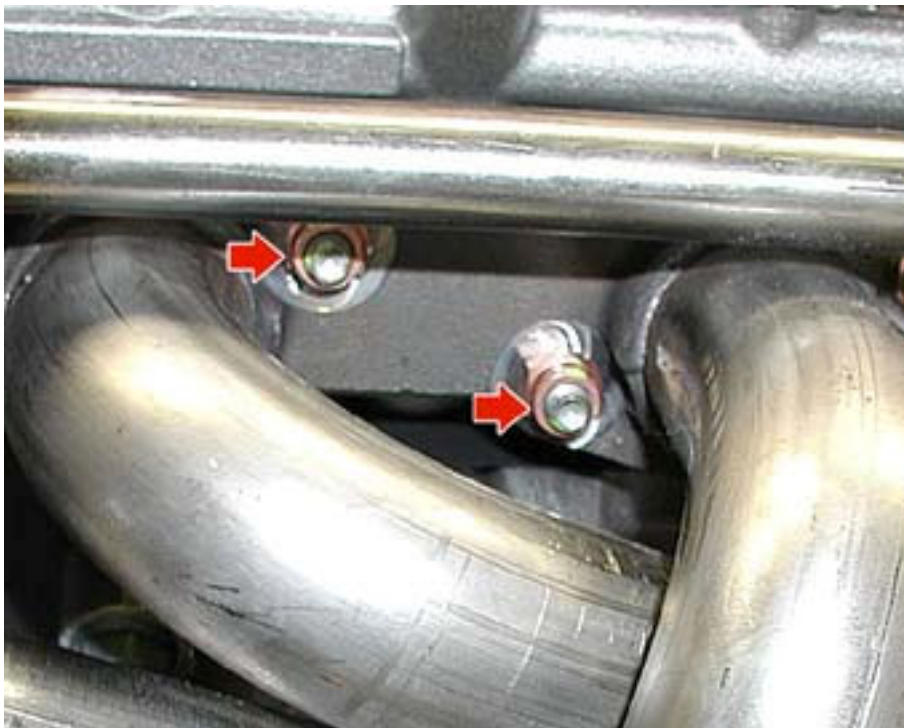

- Keeping the hoist lifted, unscrew the remaining nuts fastening the exhaust manifolds to the heads, then remove them.
- Retrieve the exhaust manifold gaskets.



Refitting the exhaust manifolds

IMPORTANT

The procedure below illustrates how to fit the exhaust manifolds for the USA-CANADA version

USA - CANADA VERSION

- Fit the new exhaust gaskets onto the stud bolts on the cylinder heads.
- Fit the two exhaust manifolds and tighten the fastening nuts accessible from lower part of the vehicle.



- Lower the hoist and tighten the two nuts accessible from the top of the RH exhaust manifold.

N.B

The fastening nuts on the exhaust manifolds must be tightened to a torque of 25 Nm.



- Tighten the screw fastening the steering column and steering box to a torque of 25 Nm.



- Fit the union **(1)**, and tighten the two screws **(2)** on the rigid secondary air piping coupling flange.

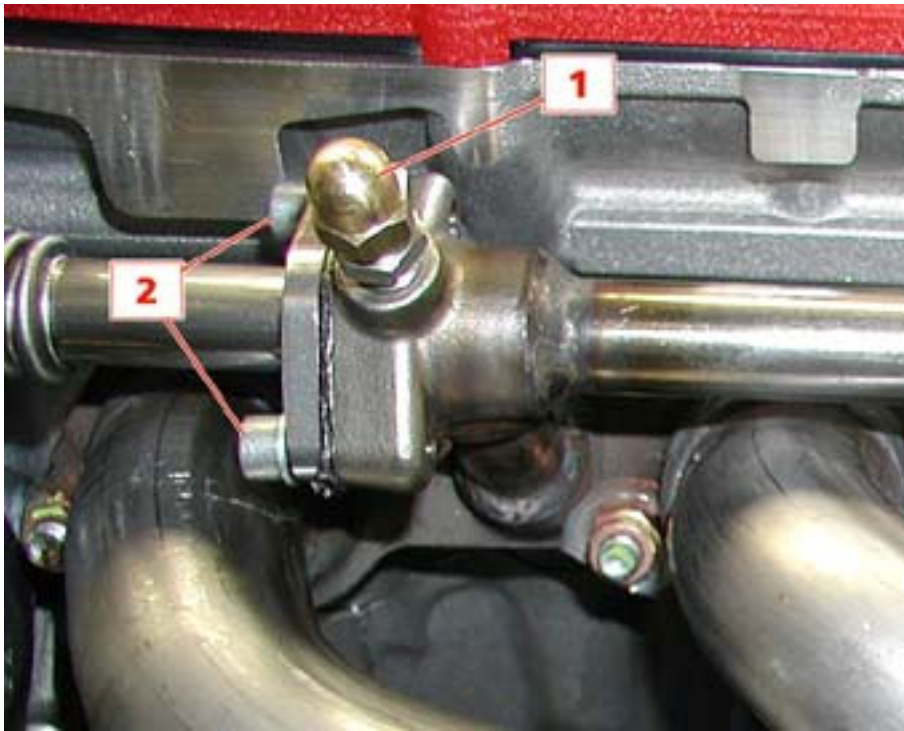

- Fit both catalytic converters.
Catalytic converters
 - Fit the engine floor guard.
Engine floor guard
 - Fit the central exhaust silencer.
Exhaust silencer
 - Fit the two exhaust extension pipes.
Exhaust extension pipe
 - Fit the exhaust tailpipes.
Tailpipe
- Remove the car from the hoist.

ENGINE REMOVING

- Position the engine, without the clutch, onto the support stand **AV2023** , fixing it with the support tool **900026310**.
- Open the two fastening clamps **(1)** of the vapour recirculation line.



- Remove the clamp **(1)** and disconnect the vapour recirculation line from the tappet cover of the right-hand cylinder bank.



- Remove the clamp **(1)** and disconnect the vapour recirculation line from the tappet cover of the left-hand cylinder bank.
- Remove the complete line from the engine.



- Disconnect the flexible hose from the rigid pipe.



- Unscrew the nut (1) and remove the flexible hose (2) complete with fastening clamp. Unscrew the nut (3) and remove the line support bracket (4).

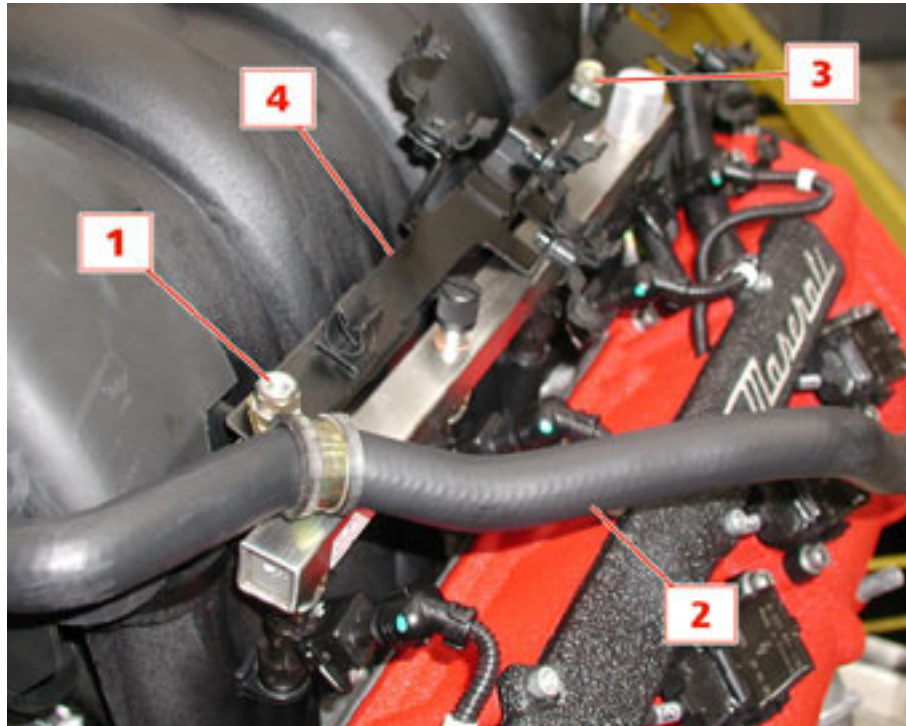

- Unscrew the nuts (1), detach the electrical connectors of the electro-injectors (2) and remove the fuel manifold complete with electro-injectors (3).

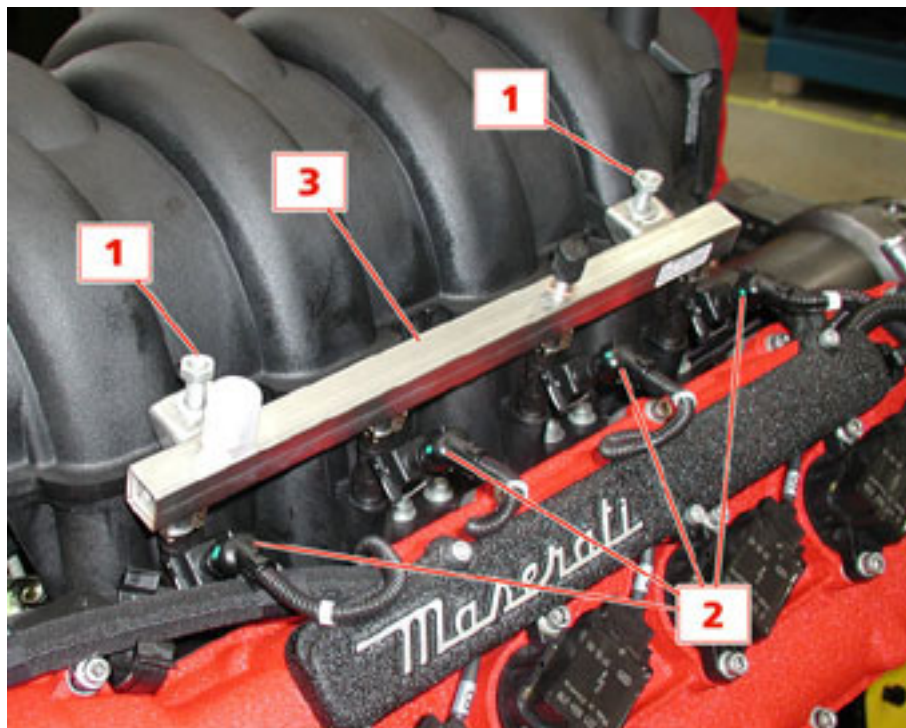

- Disconnect the wiring from the motor driven throttle.

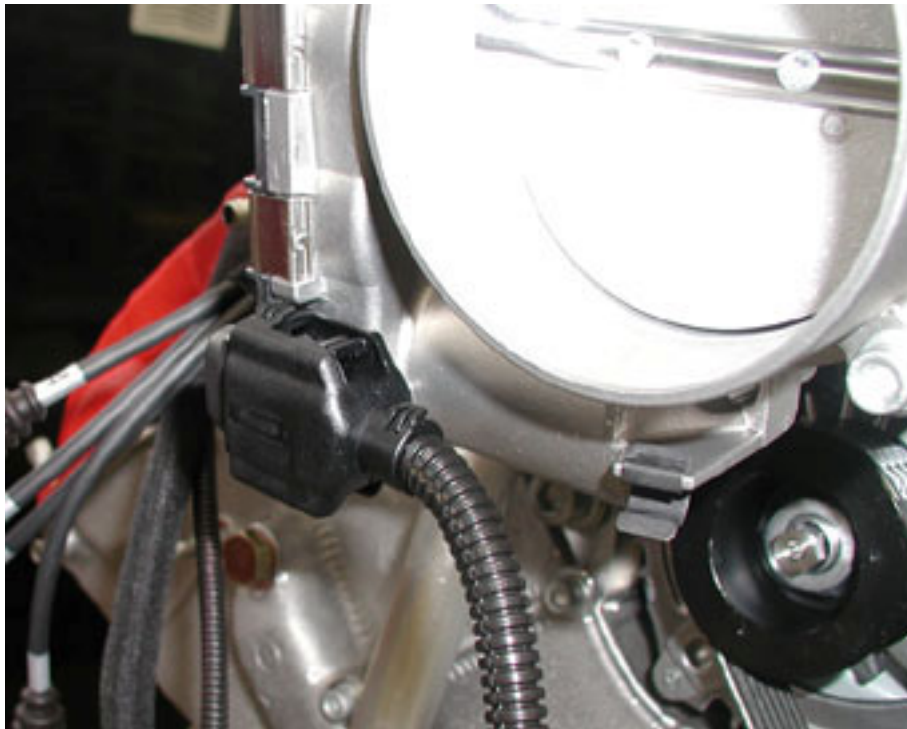

- Unfasten the bolts on the intake manifold.



- Remove the intake manifold by lifting it upwards.



- Remove the gaskets on the intake ducts.



- Fit the tools **AV3332**, securing them with two nuts to avoid allowing foreign bodies to enter the cylinders.



- Remove the wiring covers.



- Detach the ignition coil connectors, check that all wires are identified in order to position them correctly during the reassembly stage.



- After having detached the solenoid valve connection in the timing variator, move the coil wiring and the injector wiring.



- Remove the retaining clamps, detach the connection on the water temperature sensors and move the wiring on the clutch side.



- Remove the battery-generator wire.



- Disconnect the wiring on the air conditioning system compressor.



- Detach the connections on the alternator and remove the wiring.



- Detach the connections on the detonation sensors, the timing sensors and the revolution sensor on the supporting bracket.



CAUTION

Check that the sensors on each wire correspond, consulting the electric system manual if necessary.

- Unscrew the injection wiring's seven retaining clamps.



- Remove the engine wiring's earth connection.



- Take away the engine wiring.



- Undo the retaining screws and remove the engine mounting brackets.

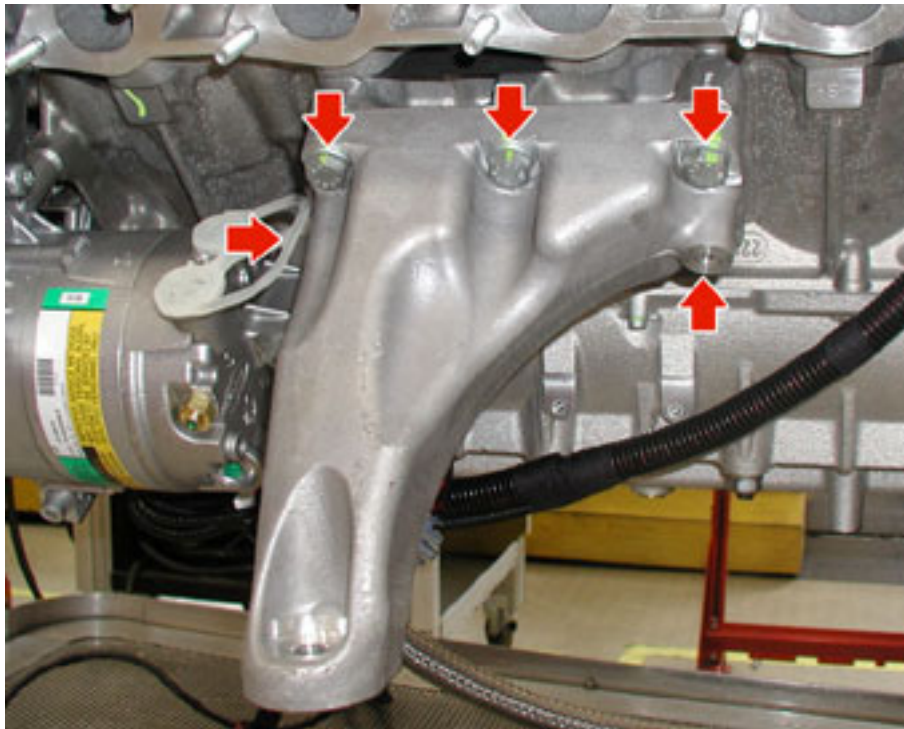

- Remove the starter motor.



- Loosen the poliV belt by turning the tensioner and, holding the tensioner back, slide the belt off the pulleys and remove it.



- Undo the screws fastening the air conditioning system compressor and then remove it.



- Remove the **6 mm** screw from the hydraulic steering pump using the holes on the pulley.



- Unfasten the two **8 mm** screws and remove the pump.



- Open the clamps on the heads' water outputs and remove the entire connecting pipe.



- Take the bearing out of the clutch shaft support using the extracting tool **95972714**.



- Fit the tool **900026560** for locking the crankshaft.



- Remove the torsion damper Once the fastening screw has been removed, the damper can be taken out by hand.

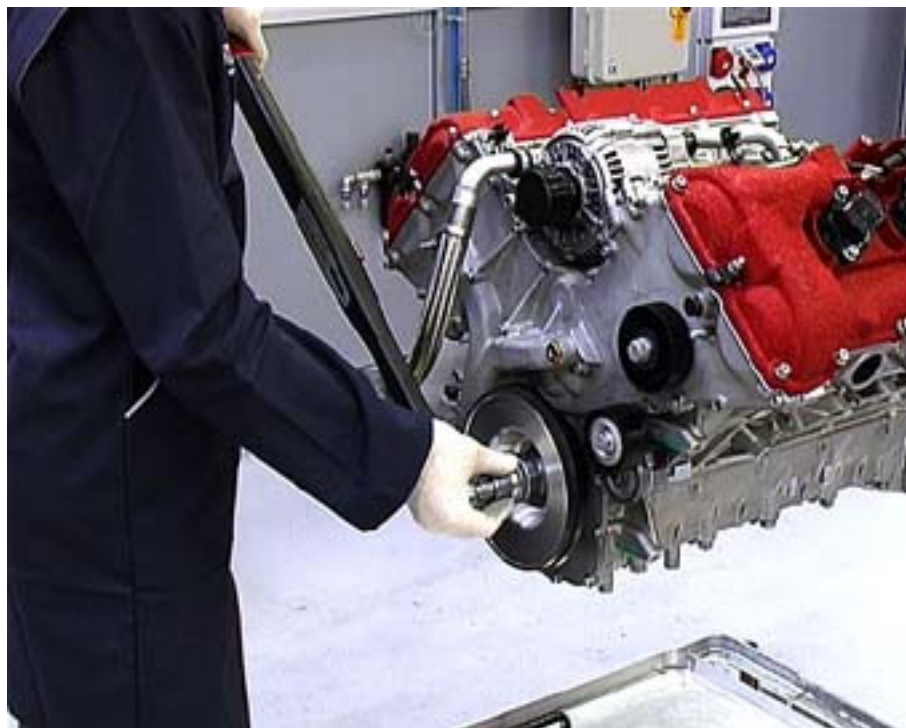

- Remove the tool **900026560** for locking the crankshaft.



- Remove the belt tensioner, undoing the 8mm fastening screw.



- Remove the fixing bracket for the pipe which runs from the exchanger to the oil tank.



- Remove the pipe running from the exchanger to the oil tank, unscrewing the **36 mm** nut.



- Undo the two screws fastening the alternator and remove it by moving it upwards.



- Remove the ignition coils by unfastening the two retaining screws.



- Extract the retaining seeger ring from the timing variator's wire guide.



- Place the connectors for the timing (rh and lh), revolution (rh) and detonation (four) sensors into their housings on the support bracket.

CAUTION

Check that the sensors on each wire correspond, consulting the electric system manual if necessary.

N.B.

If necessary, remove the timing sensors (Figure 2).



- To remove the tappet covers, the stud bolt supporting the wiring and the fourteen perimetral socket head screws must be unfastened.



- Lift the cover, taking care to slide out the solenoid valve wire on the timing variator.



- Remove the two fastening screws from the left-hand bank belt tensioner.



- Remove the screws from the cover.



- Using a screwdriver, separate the front cover from the engine.

N.B.

Keep the gasket located between the upper edge of the housing and the left-hand belt tensioner.



- Keep the upper gasket and remove the cover (**Figure 1**).

N.B.

The lower gasket remains attached to the cover: remember to keep it for future assembly (**Figure 2**).

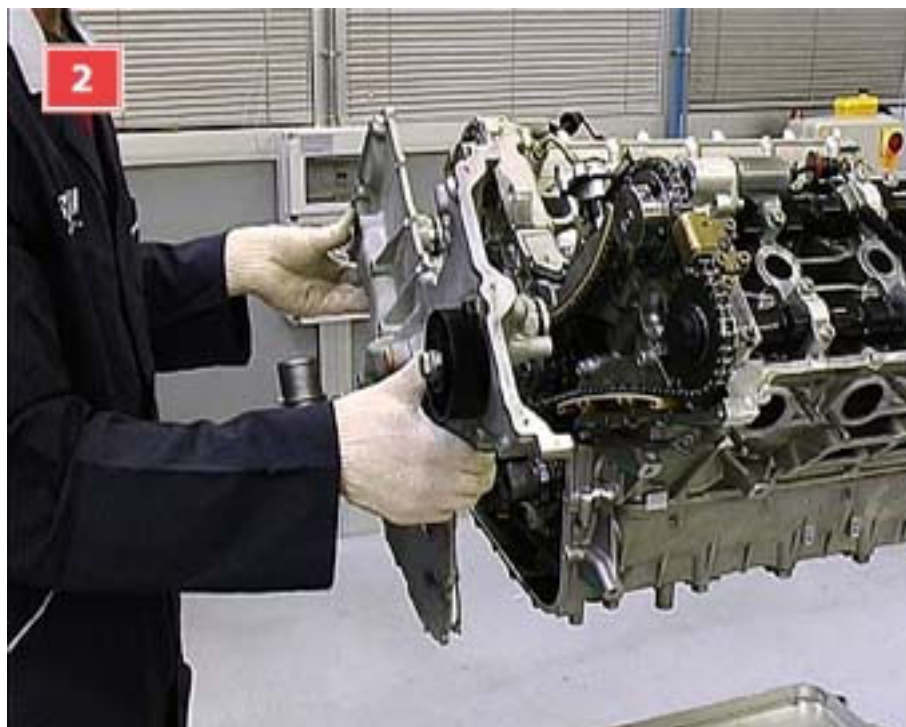

- Remove the mechanical tensioner from the oil-water pump chain.



- Remove the fixed shoe.

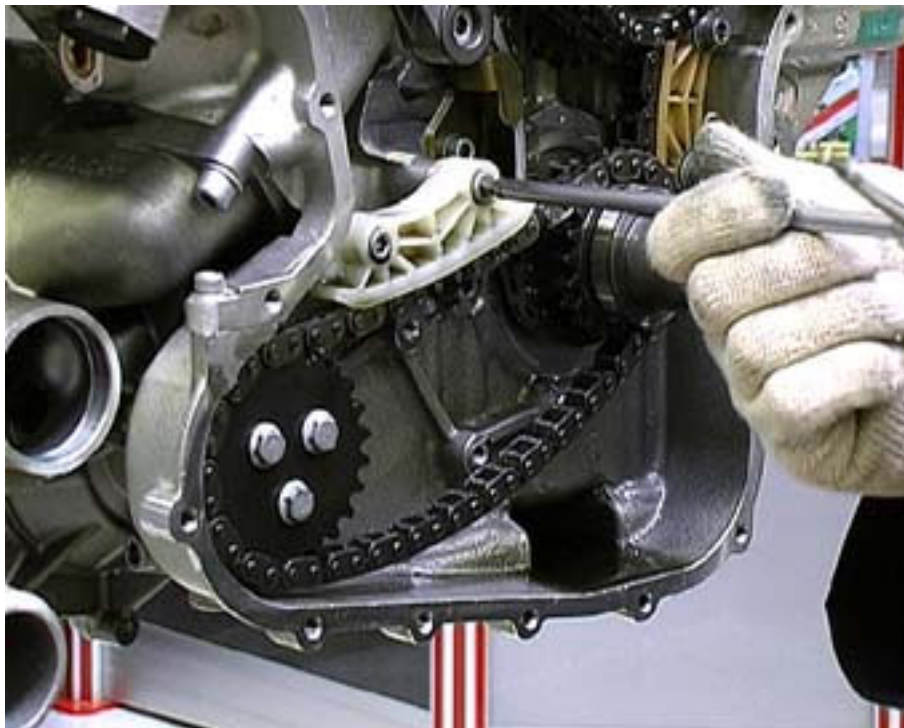

- Undo the screws on the pump's toothed control wheel and remove it along with the chain.

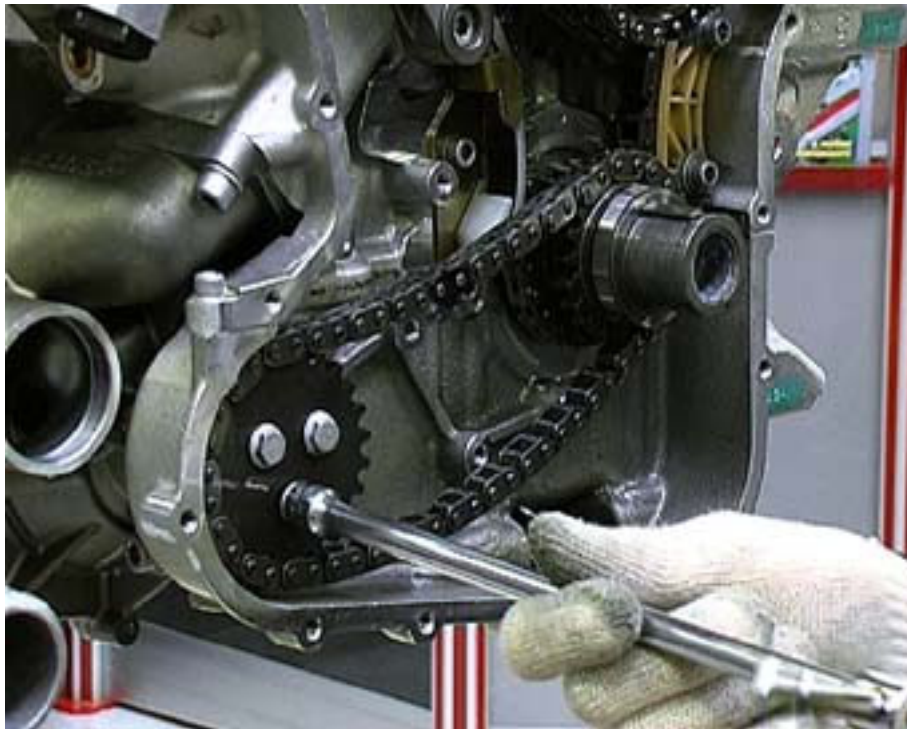

- Undo the screws which fix the oil-water pump to the crankcase.



- Move the oil-water pump backwards by hitting it lightly with a rubber hammer, and then remove it.

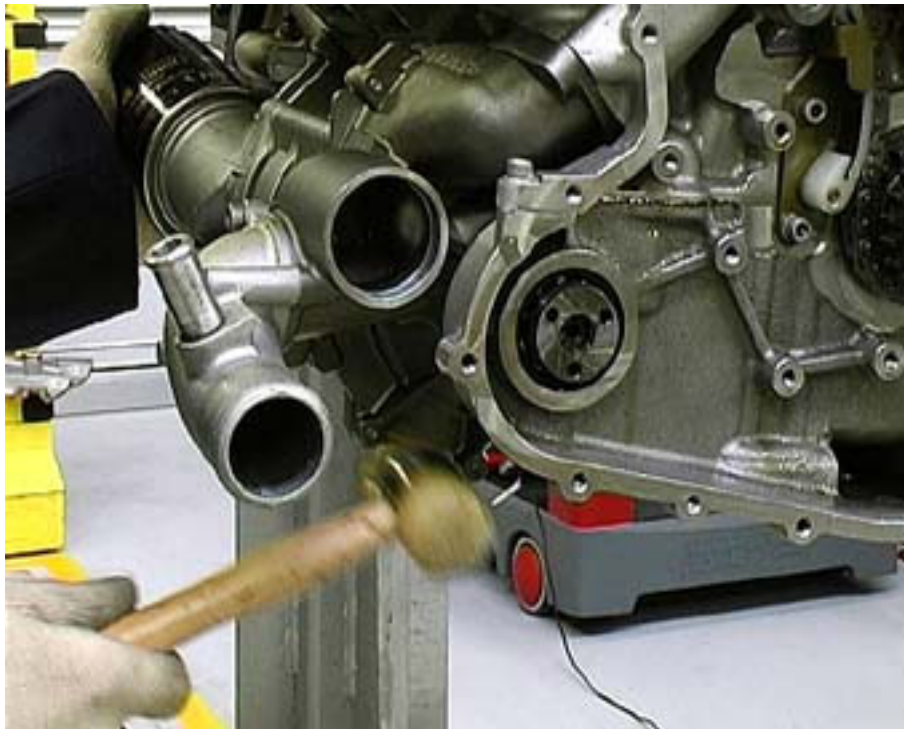

- After removing the pump, check through the three inspection holes that there are no leakages or spills.

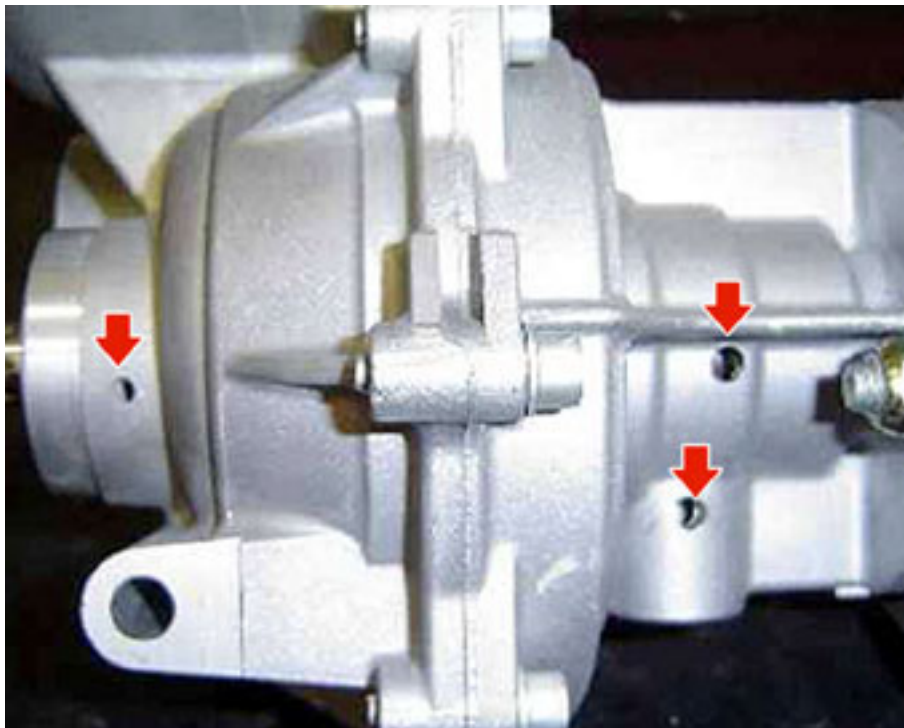

- Remove the tensioners from the timing chains (**Figure 1 and 2**).



- Remove the upper fixed shoes.



- Remove the timing system's movable shoes.



- Remove the exhaust camshaft screw, countering the rotation with a wrench inserted into the special hexagon machined on the shaft.



N.B.

If it is necessary to keep the same timing, mark the toothed wheels and the chains(Figure 1 and 2) at the correct point.

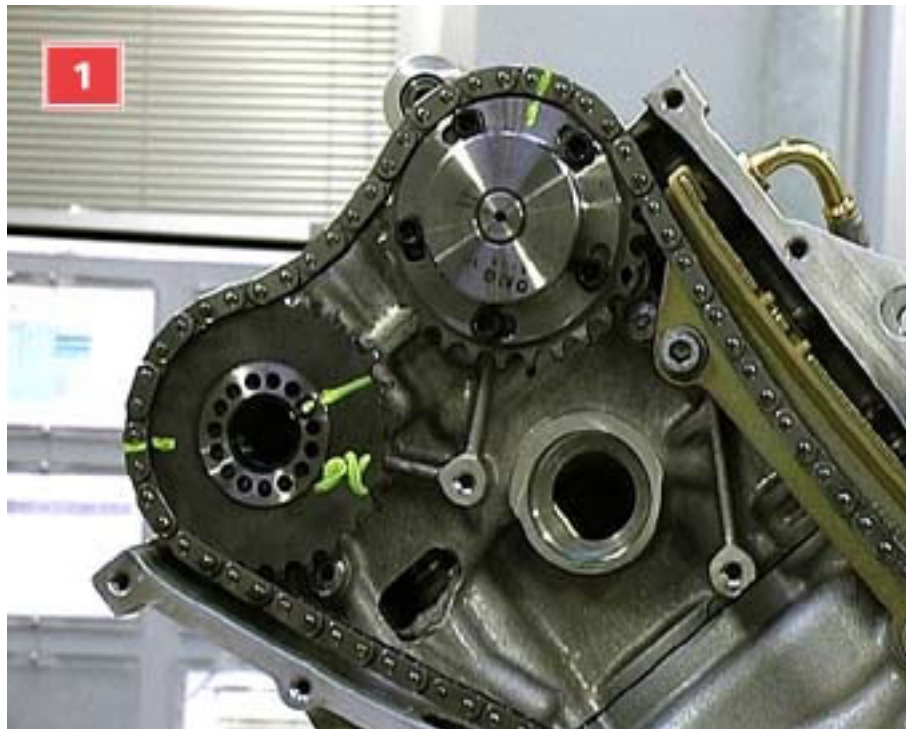

- Proceed with removing the chains, sliding the toothed wheels off the exhaust camshafts (**Figure 1**).

N.B.

Keep the centring dowel (Figure 2).



- Remove the timing chain's fixed shoes.



- Remove the transmission axle's mechanical tensioner and the fixed shoe.



- Take the seeger ring and the relative shim off the transmission axle.



- Slide out the toothed wheels, paying attention to the roller cages on the transmission axle.



- Remove the transmission axle, paying attention to the grommet.



- Remove the union pipes leading from the oil accumulator to the heads.



- Unfasten the retaining nuts on the camshaft caps.



- Remove the oil filter.

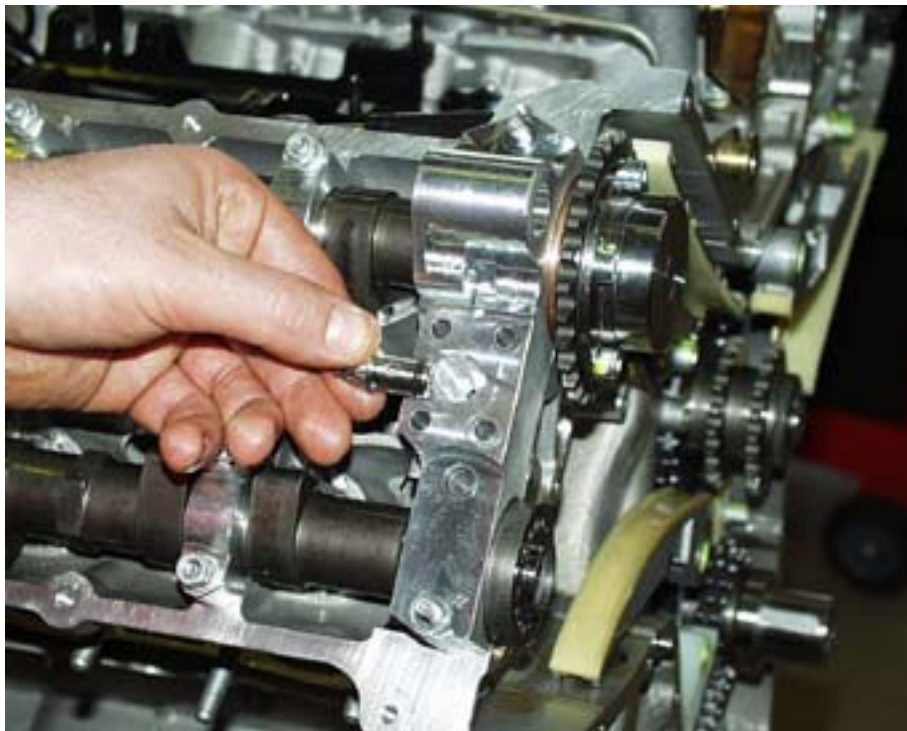

- Remove the screws which fasten the timing variator oil pump onto the left-hand bank intake camshaft.
- Remove the caps checking that the reference number is stamped on them.



- Remove the exhaust camshaft and then the intake camshaft.

N.B.

In this last stage, be sure to recover the timing variator tabs.



- If necessary, remove the continuous timing variator using tool **900027020**, provided for this purpose.



- Using a magnet, take the valve buckets out of their seats, checking their reference numbers.



- Unscrew the ten head fastening nuts.



- Remove the heads using a rubber hammer if necessary.



- Remove the head gaskets.



- Unscrew the RPM sensor.



- Proceed with the removal of the sub-crankcase by unfastening the perimetral screws.



- Unfasten the nuts on the sub-crankcase stud bolts.



- Move the sub-crankcase away by hitting it lightly with a hammer and then remove it completely.



- Remove the crankshaft oil seal.



- Fit the tool **AM105786** onto the crankshaft and rotate the shaft in order to gain access the connecting rod bolts easily.



- Loosen the connecting rod caps and move them away by hitting them lightly with a hammer. Remove the bolts by hand and take off the caps.



- Remove the crankshaft and the bearings (**Figure 1**) taking care not to drop the crankshaft's central support shimmings (**Figure 2**).

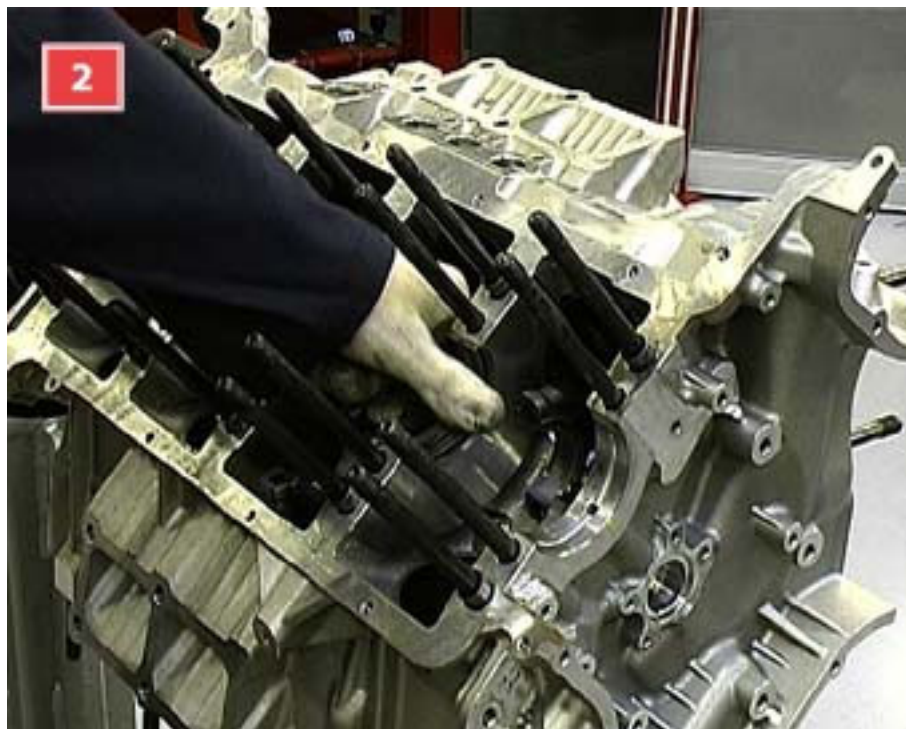

- Remove the pistons.



- Remove the oil nozzles underneath the pistons.



- Remove the cylinder liners using the tool **900026610**.



- Remove the oil pressure sensor, the revolution sensor.



- Unscrew the four anti-detonation sensors.

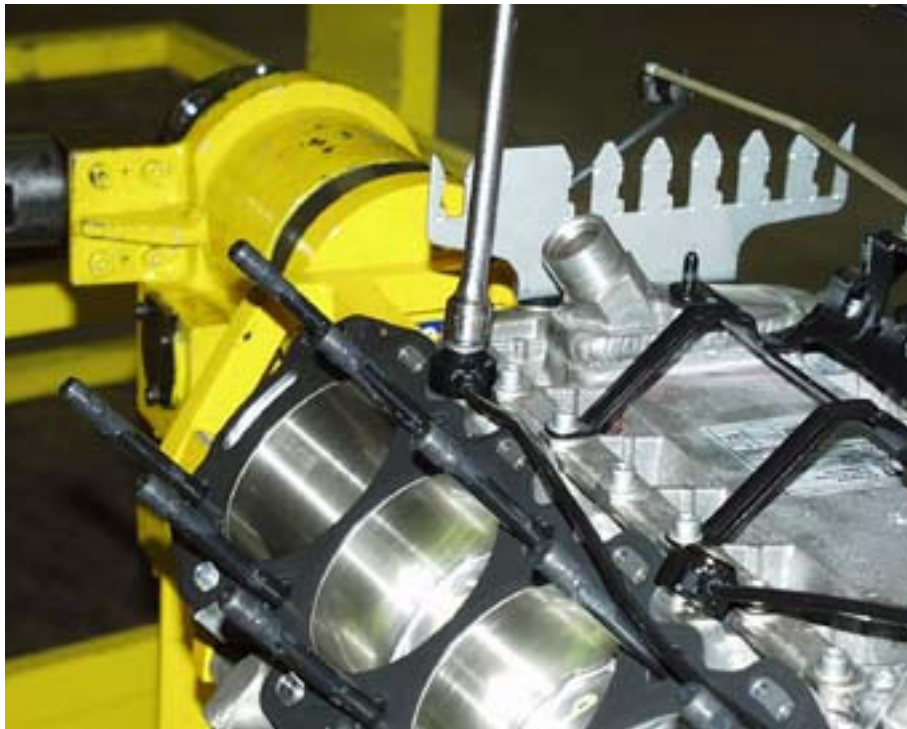

- Remove the oil accumulator for the variators.



- Remove the heat exchanger.



FITTING AND TIMING THE ENGINE

In order to install the cylinder liners, the crankcase must be heated up in an oven. The crankcase must be completely bare.

The chokes for the pressurised oil delivered to the heads have different diameters and are fitted on both cylinder banks. Each choke is fitted on a check valve. Upon each

overhaul, it is essential to check that this valve is clean and that it works properly. The crankcase is removed using an extracting tool, while for reassembly it is interference fitted.

Using tool **AV3605** (not illustrated) loosely fit the choking dowels.

N.B.

During the reassembly stage, check that the oil choking dowels on the heads are installed correctly: the dowel with a 5.5mm internal diameter is found on the left-hand bank (Fig. 1), while that with a 3mm internal diameter is found on the right-hand bank (Fig. 2).





- After checking the dimensions of the cylinder liners and the respective seats in the upper crankcase, check that the cylinder liner resting surfaces are perfectly clean, then measure the liner protrusion with respect to the crankcase as follows:
- Fit the cylinder liner to be installed turned upside down on the crankcase.
- Using the specific tool equipped with dial gauge with DTI plunger **CS0102916** measure the protrusion of the cylinder liner from the crankcase, checking that it falls within the **0.001÷0.05 mm** value range.
- If necessary, try the various liners in the various seats so as to obtain the correct coupling.
- It is important that the protrusion is uniform for all the cylinder liners on each bank.
- After coupling the various cylinder liners to the respective seats, number them in order to prevent a coupling error during assembly.



- Heat the bare crankcase in an oven for about 60 minutes to a temperature of 40-50°C, and cool down the cylinder liners to a temperature of -15 to -20°C putting them in a freezer or liquid nitrogen.
- When the specified temperatures for the crankcase and the cylinder liners have been reached, fix the crankcase on the support tool and proceed with installation as follows.
- Position the O-rings on the cylinder liners and lubricate them with engine oil.



- Insert the cylinder liners in the crankcase, carefully respecting the coupling order established when checking the protrusion, and take care that the two adjoining faces of the upper edge, between the various cylinder liners, do not interfere with each other.
- To fully bed in the cylinder liner, evenly tap on its perimeter with a rubber hammer.
- The cylinder liners must be fitted within two minutes from taking the crankcase out of the oven.
- Check once again that the total cylinder liner protrusion for each cylinder bank is between **0.01 and 0.05 mm**.



- If the cylinder liners are not replaced, but the same ones are reinstalled in their seats, always check the protrusion of the coupling edge with respect to the crankcase, in order to make sure that there are no faults.
- Make sure that there is no interference between the adjoining faces of the upper edge.



- When installing the water/oil heat exchanger, it is advisable to visually inspect the conditions of the radiator core. Thoroughly clean the part to assure maximum heat dissipation in operating conditions.
- To check that there is no leakage or spillage, before installing the heat exchanger, perform a pressure test by immersing it in a container of water, plugging one of the two inlets and blasting in air from the other inlet.

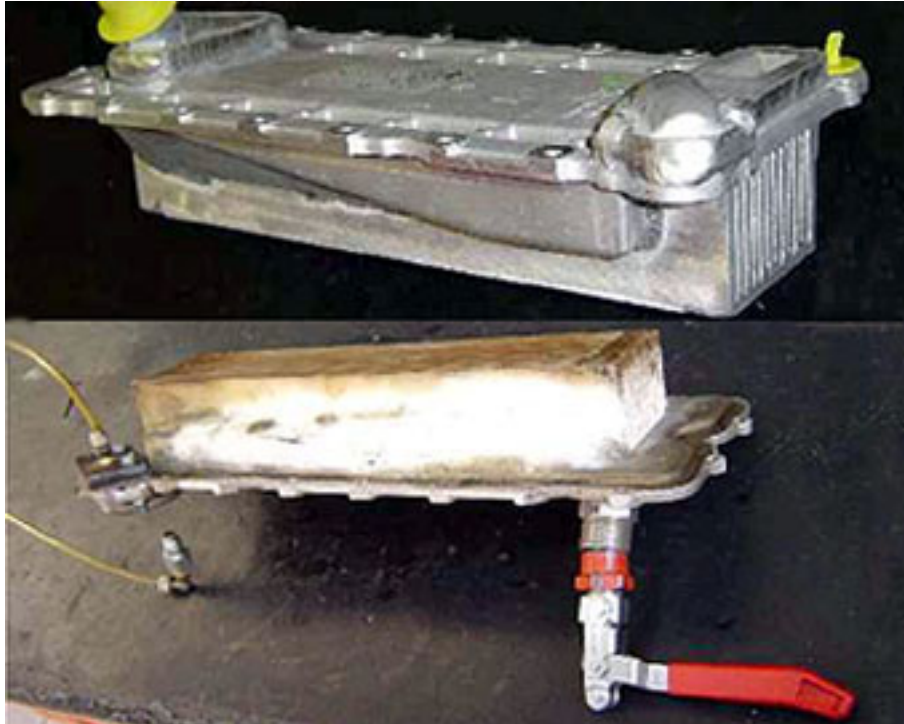

- If the centring dowels (1) for the Ø 6 heat exchanger on the crankcase are damaged or have been removed, you must use tool **900026300** together with tool **900027010**.

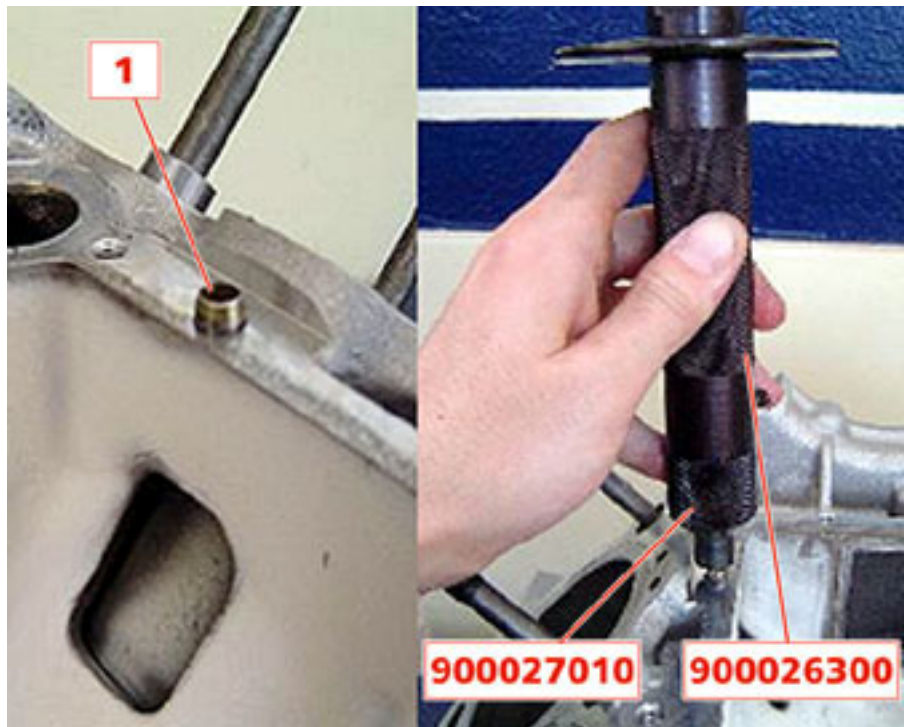

- Position the heat exchanger.



- Always replace the adhesive gasket of the heat exchanger.

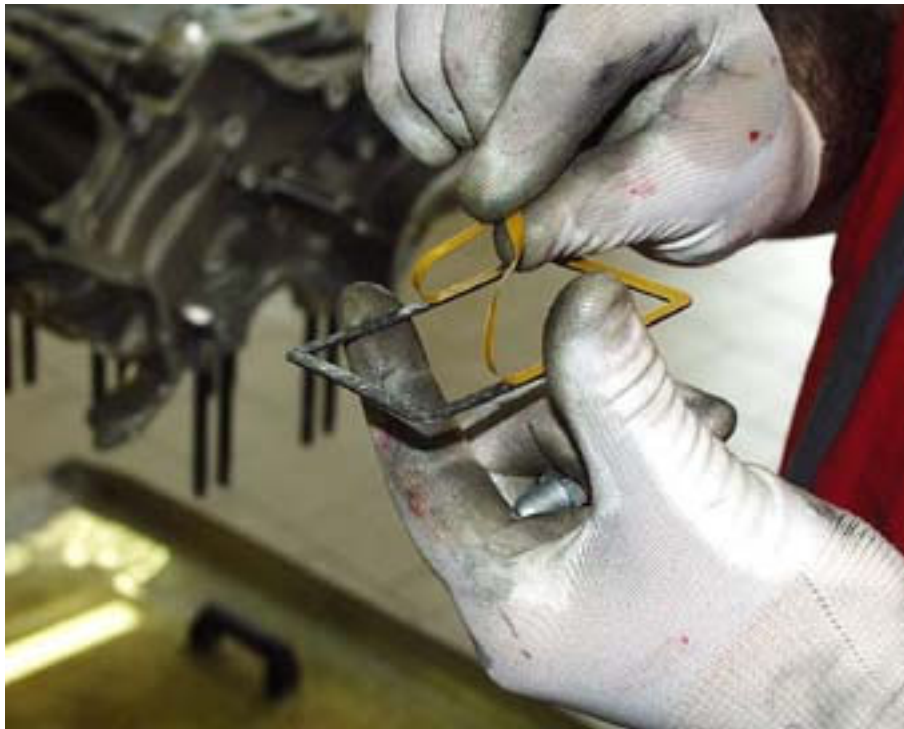

- Properly fit the gasket on the heat exchanger.



- Install the sealing gasket (1) between the heat exchanger and the crankcase and position the heat exchanger.



- Fit the accumulator mount.



- Fit the air bleeding union for the water cooling circuit and tighten it to a torque of **15Nm**.



- Fit the accumulator mount and tighten it with the exchanger to a torque of **10 Nm**.

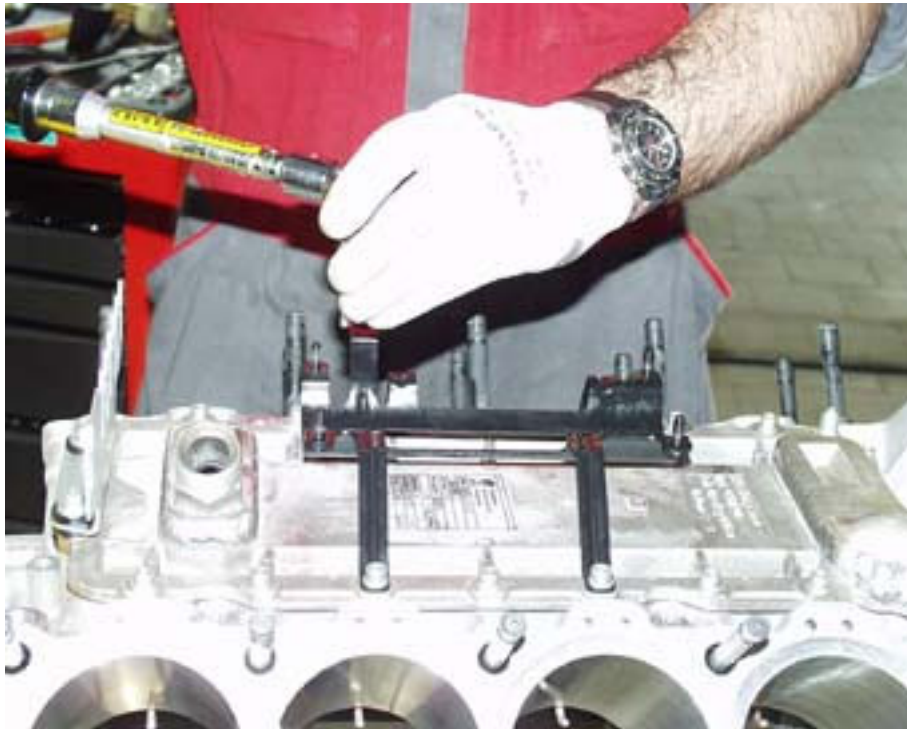

- Fit the four anti-detonation sensors and tighten them to a torque of **20 Nm**.



- Fit the rpm sensor and tighten it to a torque of **8 Nm**.



- Fit the oil accumulator for the variators.



- Fit the oil pressure sensor taking care not to damage the rpm sensor cable and tighten it to a torque of **40 Nm**.



- After having applied a thin layer of Loctite 242 on the oil nozzles, install and tighten them to a torque of **3 Nm**.



- Position the piston sealing segments in the direction shown in Figure **(A)** with the openings of the first **(1)** and the second **(2)** sealing segment at **180°** between them, as shown in Figure **(B)**.



- (1) = Upper sealing segment opening
- (2) = Central sealing segment opening

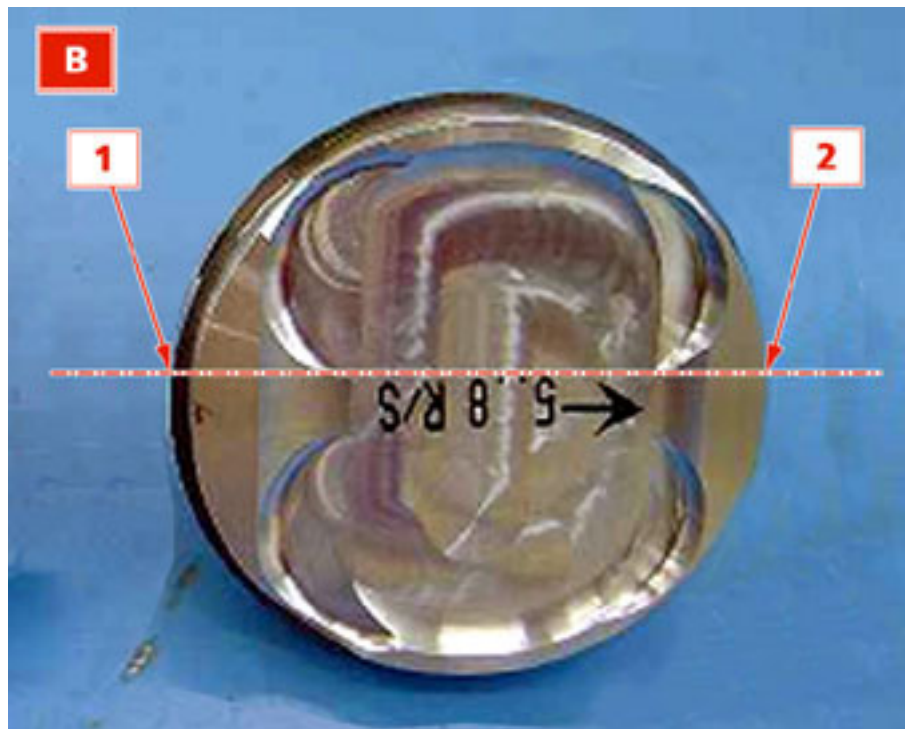

There is no specific fitting direction for the oil scraper ring, nonetheless, take care at the joint of the internal clip: do not position it near the opening of the upper and lower rings.



- Mount the connecting rod on the piston, taking care that the mark on the lower part of the connecting rod is positioned on the piston exhaust side.

IMPORTANT

After every removal, replace the pin stop rings. The connecting rod caps match the respective connecting rods. An identification number is printed on both the connecting rod and the connecting rod cap.



- Lubricate the piston skirt and the cylinder liner with engine oil.



- Fit the half-bearings into their seats on the connecting rod and the cap.



UNIT OF MEASURE mm		CRANKPIN	CRANKPIN
		CONNECTING ROD SEAT	CONNECTING ROD SEAT
SEAT YIELD= 0.008		47.129 – 47.135 CLASS X	47.136 – 47.142 CLASS Y
CRANKSHAFT CRANKPIN	43.630 – 43.637 CLASS X	YELLOW 1.727 – 1.732 YELLOW 1.727 – 1.732	GREEN 1.732 – 1.737 GREEN 1.732 – 1.737
CRANKSHAFT CRANKPIN	43.621 – 43.629 CLASS X	GREEN 1.732 – 1.737 GREEN 1.732 – 1.737	BROWN 1.737 – 1.742 BROWN 1.737 – 1.742
THE CLEARANCES ARE CALCULATED AT A REFERENCE TEMPERATURE OF 20°C			

- Insert the piston into the dummy cylinder liner, so that the lower part of the skirt comes out slightly (**Figure 1**).
- Loosely fit the piston on the cylinder liner, taking care to observe the correct direction, then push it firmly in.

IMPORTANT

When fitting the piston, take care that the piston offset is set as in Figures 2, 3 and 4.



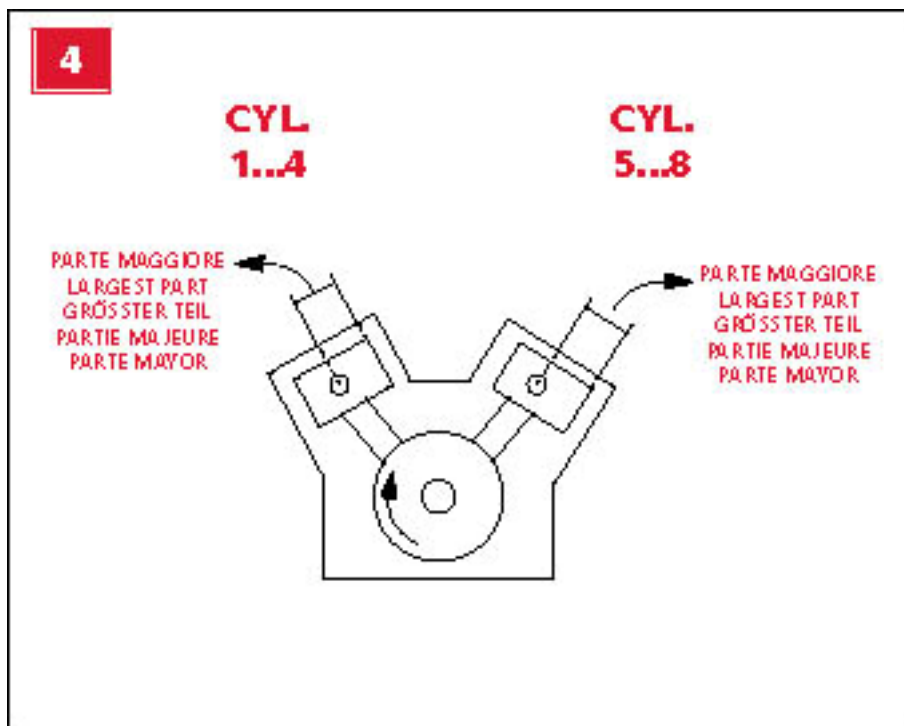

- Position all the pistons at the top dead centre before proceeding with the installation of the crankshaft, so as to avoid interference.



- Fit the bearings on the crankcase lubricating them with oil.



- Choose the main bearings according to the instructions on the table.

UNIT OF MEASURE mm		MAIN BEARING JOURNALS	MAIN BEARING JOURNALS
		CRANKCASE SEAT	CRANKCASE SEAT
SEAT YIELD= 0.035		66.675 – 66.681 CLASS A	66.682 – 66.688 CLASS B
CRANKSHAFT MAIN BEARING JOURNALS	58.994 – 59.000 CLASS A	BLUE 3.843 – 3.848 BLUE 3.843 – 3.848	GREEN 3.848 – 3.853 GREEN 3.848 – 3.853
CRANKSHAFT MAIN BEARING JOURNALS	43.621 – 43.629 CLASS X	YELLOW 3.848 – 3.853 YELLOW 3.848 – 3.853	GREEN 3.853 – 3.858 GREEN 3.853 – 3.858
THE CLEARANCES ARE CALCULATED AT A REFERENCE TEMPERATURE OF 20°C			

- Abundantly lubricate the half-bearings.

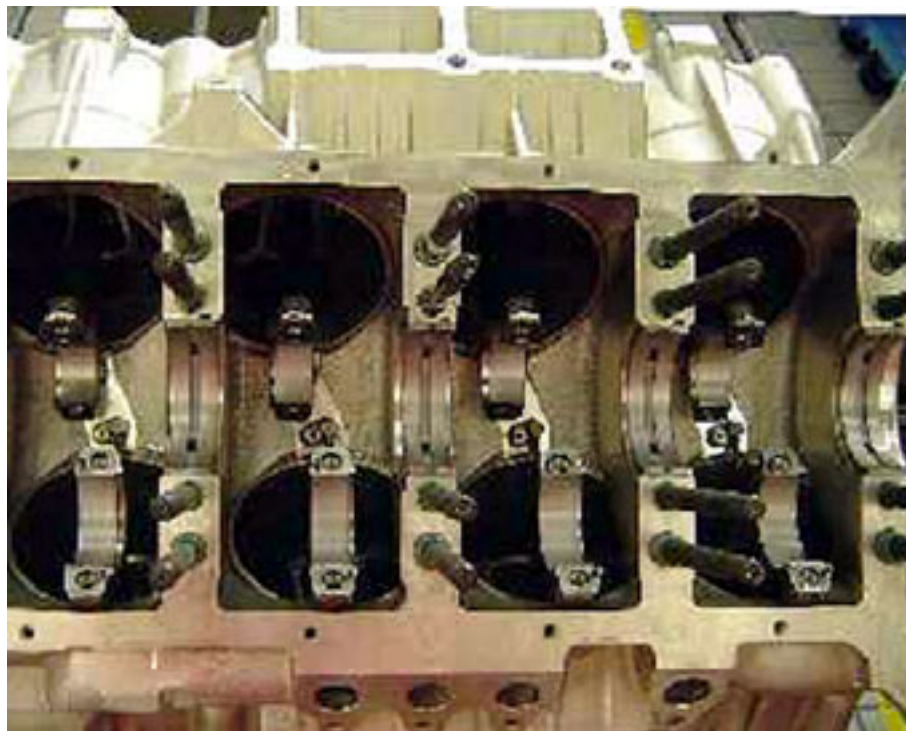

- Fit the crankshaft on its mounts.



- After having thoroughly lubricated the components, fit the connecting rod caps.

N.B.

- Be sure that the two marks on the connecting rod and the connecting rod big end are on the same side during the assembly procedure.



- Apply Molykote 1000 grease on the connecting rod tightening screws.



- After having closed them by hand first, tighten all the screws to a torque of **15 Nm**, then use a 60° tightening angle so as to obtain a torque of **55±10 Nm**.



N.B.

If the required torque is not attained after having applied the tightening angle, the entire procedure must be repeated.

IMPORTANT

Every time the connecting rod screws are tightened, use a new set of screws.

- Fit the shims for the lower central crankshaft mount, being careful with the installation direction: the side with the two lubrication grooves must face the crankshaft shoulder. These shim rings help defining the axial play of the crankshaft. Different shims are available (standard, 1st allowance, 2nd allowance) depending on the type of coupling to be achieved.
- **A** – Upper crankcase shim
- **B** – Lower crankcase shim

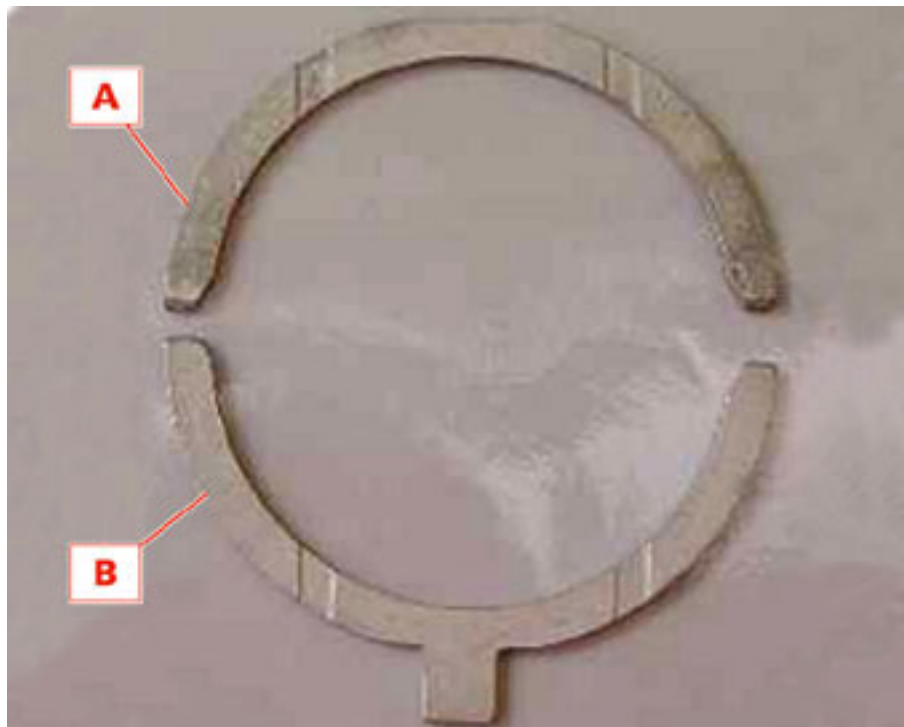

- Insert the upper central mounting shims, following the correct installation direction by turning the rounded part facing outwards.

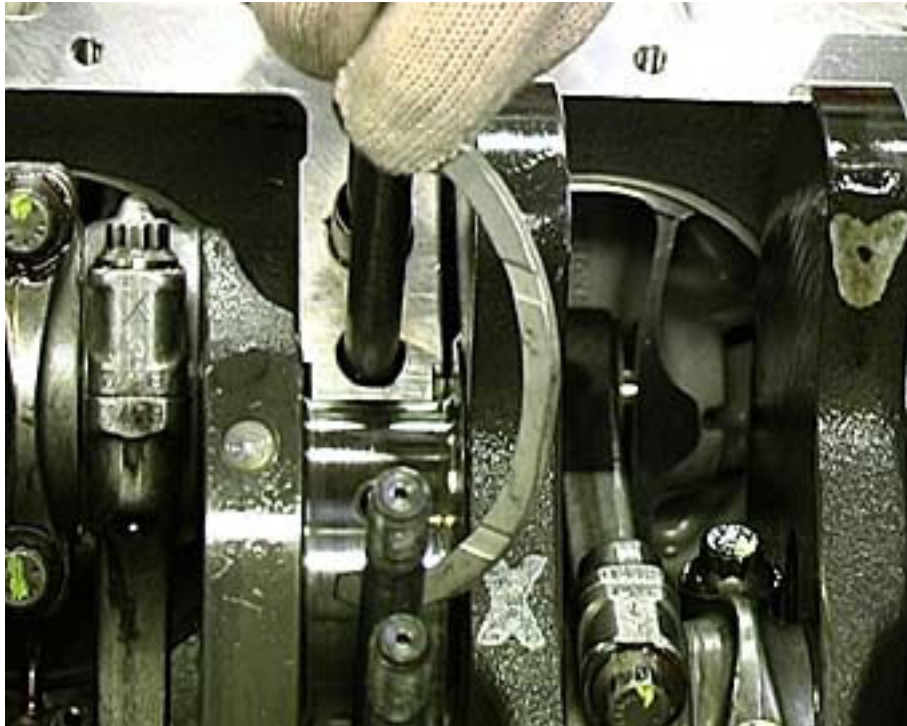

- Use the special tool (thickness 20-30) to check that the axial play of the connecting rods falls within the values **0.20-0.25 mm**.



- Put the silicon sealing compound Loctite 518 along the perimeter of the engine crankcase.



- Prepare the lower part of the engine crankcase by fitting the bearings and the lower central mounting shims, respecting the fitting direction, i.e. with the rounded part facing outwards.

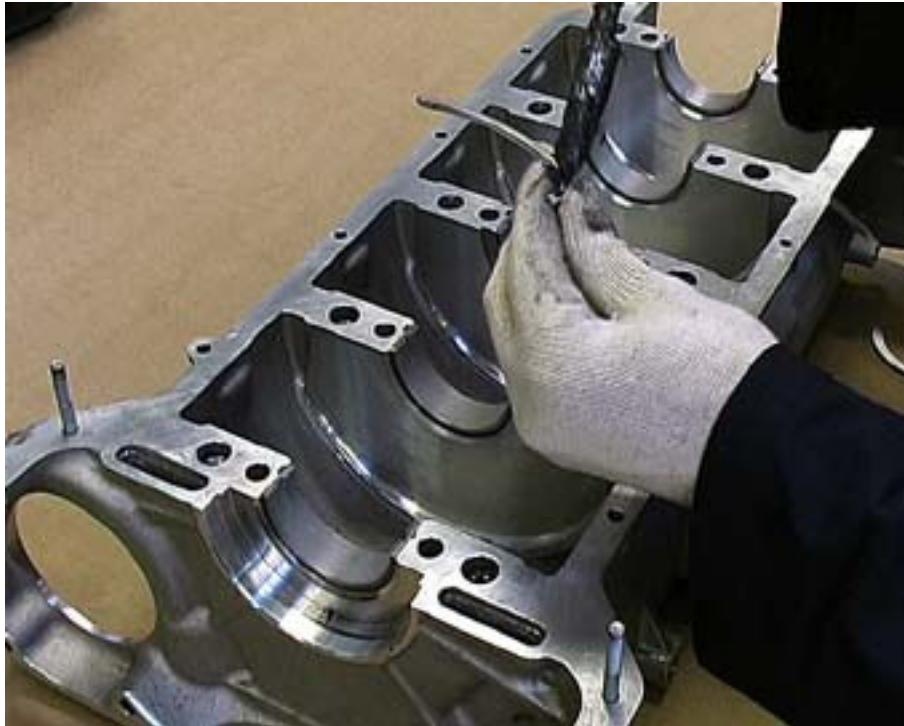

- Fit the lower part of the crankcase on the engine crankcase.

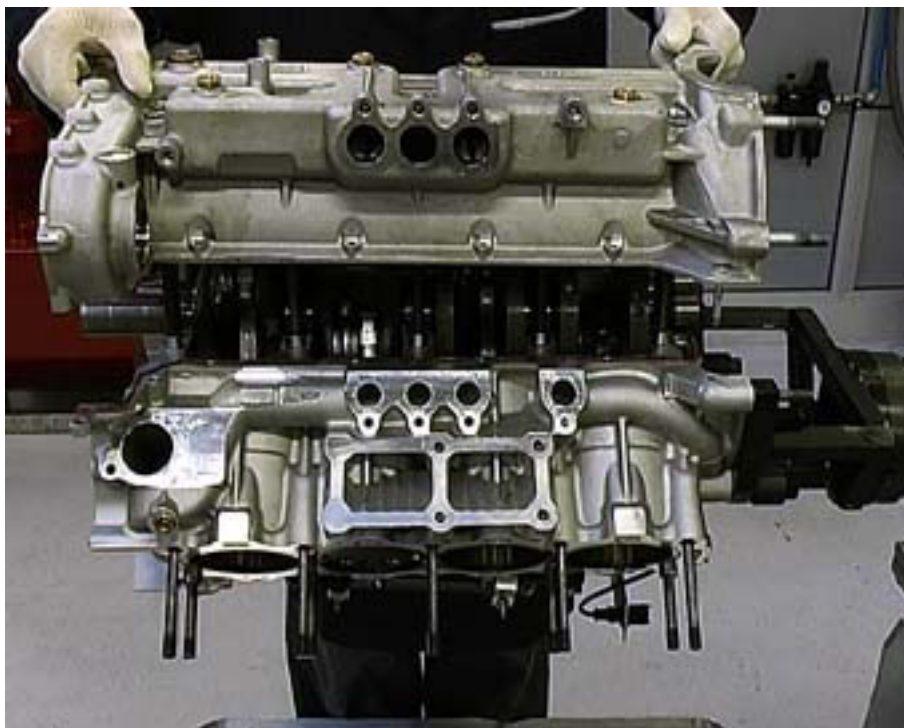

- Lubricate the tie-rods and the relative washers with Molycote 1000 grease, then loosely fit the nuts onto the stud bolts, checking that the stamped part is facing outwards.



- Tighten the nuts to a pre-load of **30Nm** for the inner nuts and **25 Nm** for the outer ones. Finally, tighten the internal ones to a torque of **60 Nm** and the external ones to a torque of **55 Nm**. During the procedure check that the shaft turns freely.



- Observe the tightening sequence.

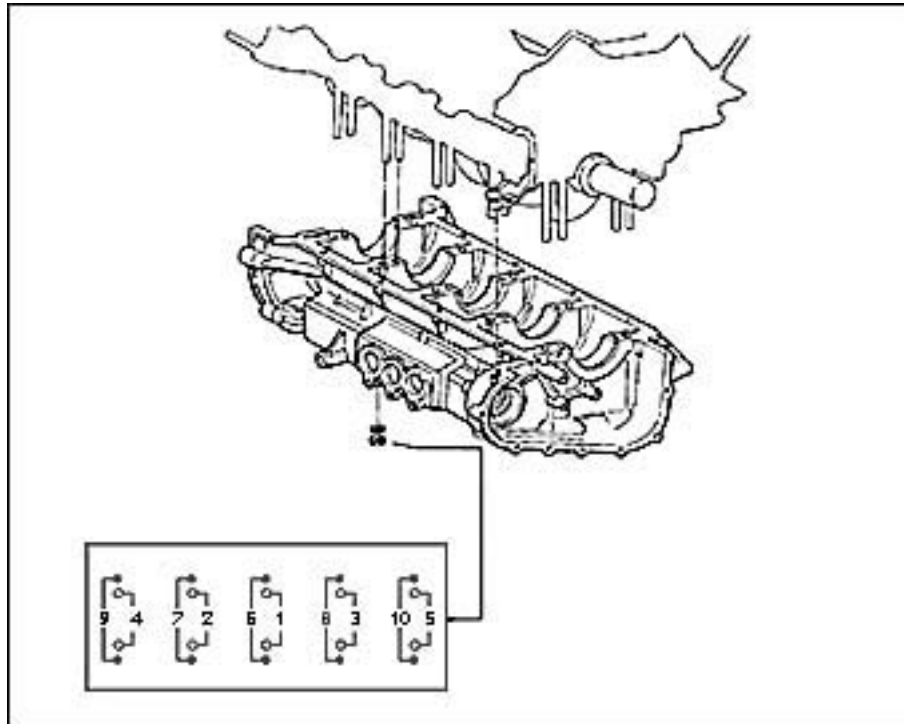

- Fit the 6mm screws onto the crankcase perimeter and the small hexagonal fastening nuts for the 2 stud bolts on the clutch side, tightening them to the a torque of **10 Nm**.



- Insert the oil seal for the crankshaft into its seat on the clutch side, using the specific tool.



- Fit tool **AM105786** for crankshaft rotation and check the shaft end float using a dial gauge. The value must fall between **0.08** and **0.18 mm**. After completing the check, it is recommended to position piston number 1 at the top dead centre.

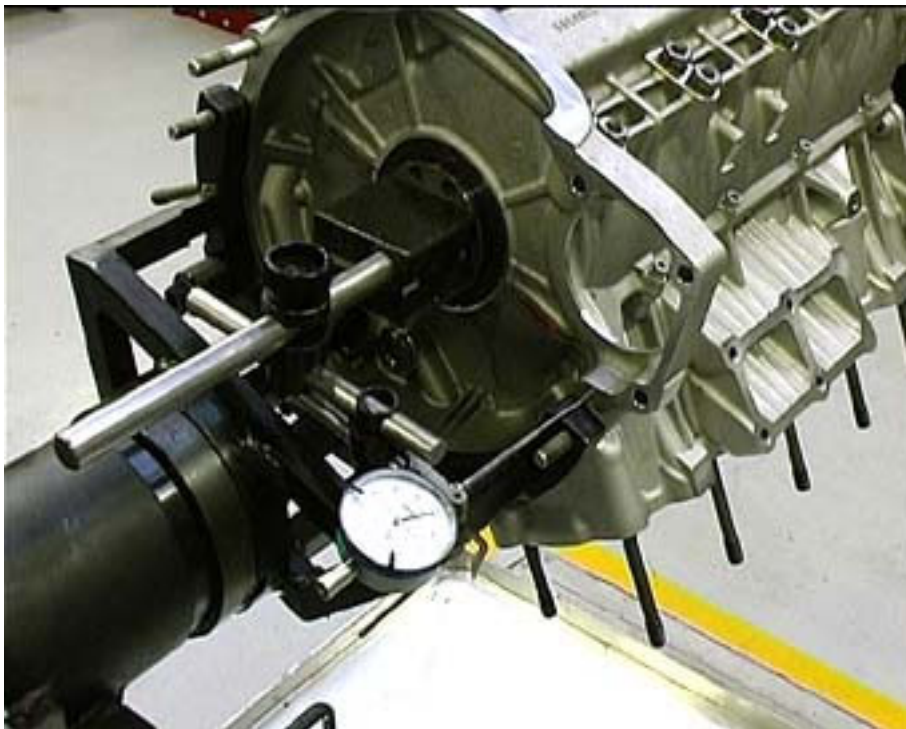

- If the head centring bushings have been damaged or removed, you must refit them using punch **900026300** equipped with tool **900027000**.

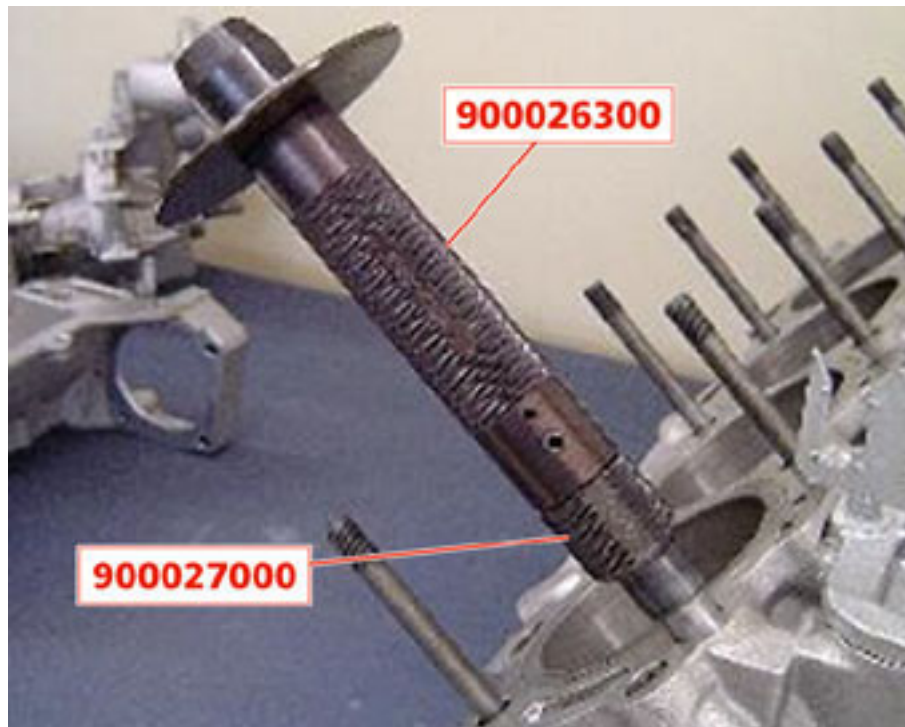

- Position the head gaskets, making sure that they are intact.

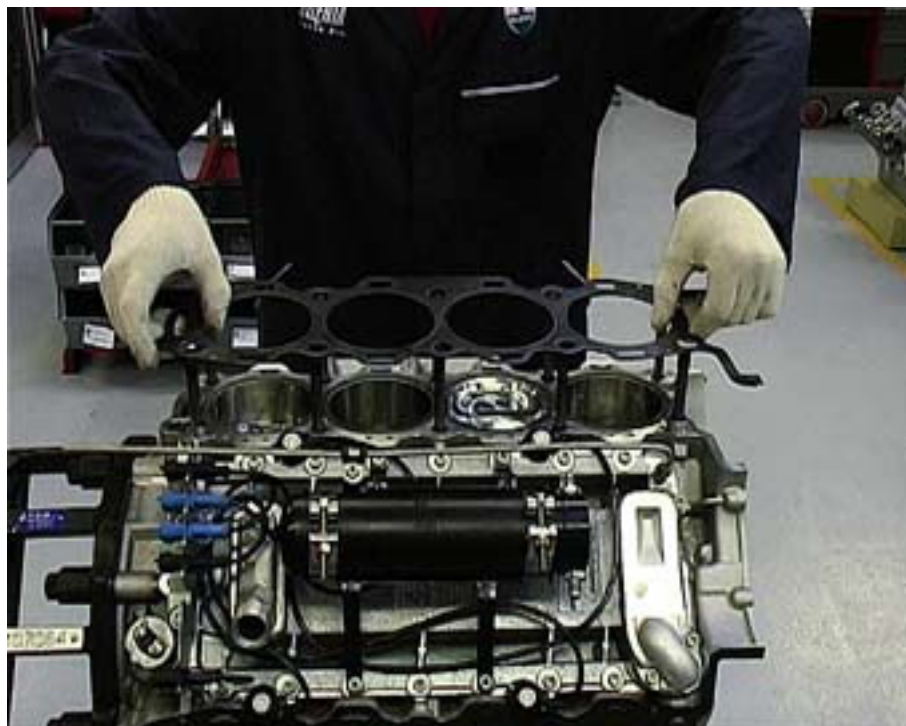

- It is advisable to apply a small amount of silicone **CAF4** on the ends of the head gaskets, on the timing side.

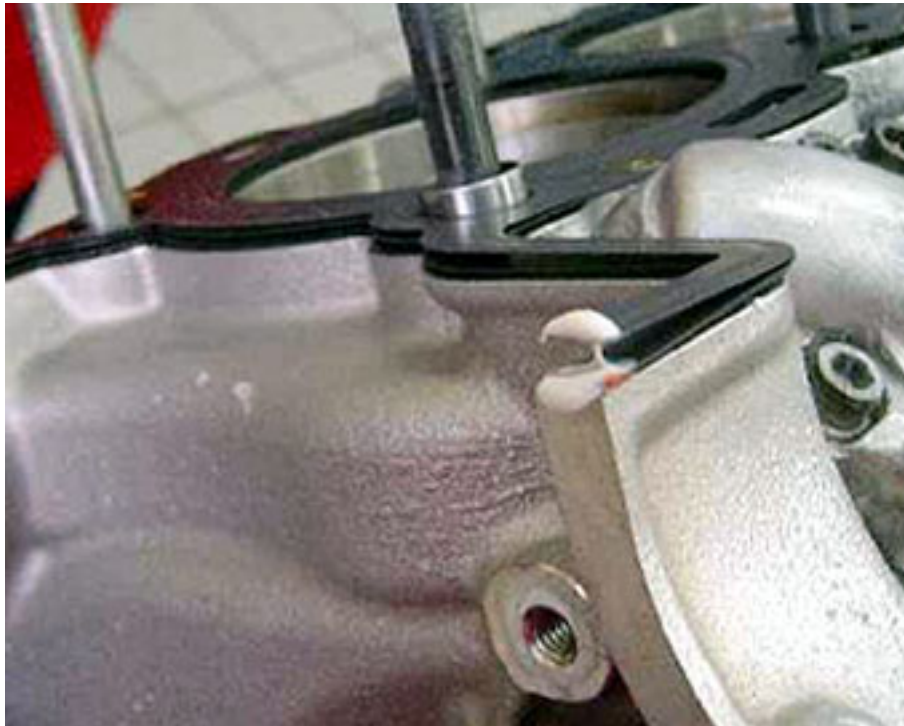

N.B.

Before fitting the engine head, turn the crankshaft in such a way that all the pistons are positioned below the TDC. To do this, you must rotate the crankshaft until the tab on the crankshaft (timing side) is positioned as shown in the figure.

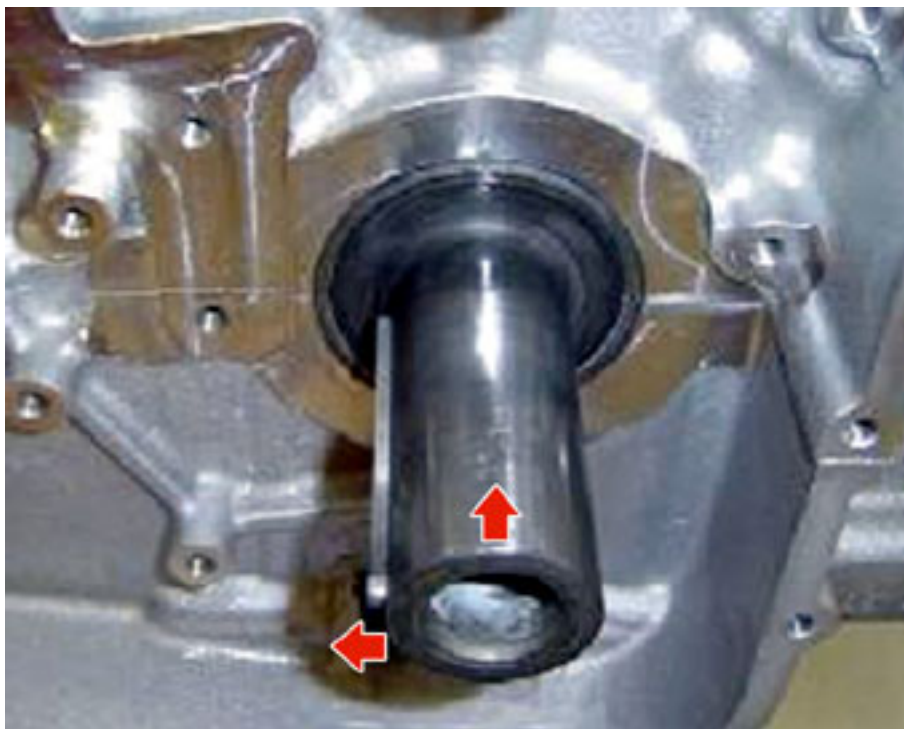

- Grease the threading of the crankcase stud bolts and the resting surfaces of the head fastening nuts.



- Grease the stud bolts with **MOLYCOTE 1000**.



- Position the heads.



- Loosely fit the nuts with the relative washers, suitably greased with MOLYCOTE 1000.



- Apply a pre-load equal to **60Nm**.

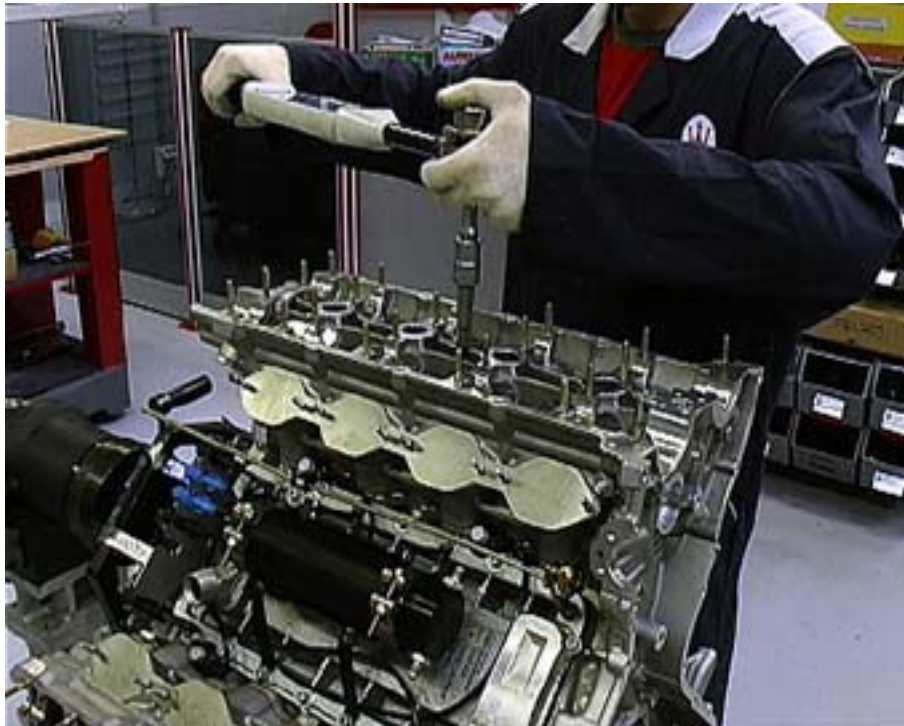

- Turn a further **90°** so as to obtain a torque of **80±10 Nm**; if the desired torque is not obtained, the operation must be repeated.



- Observe the tightening sequence.

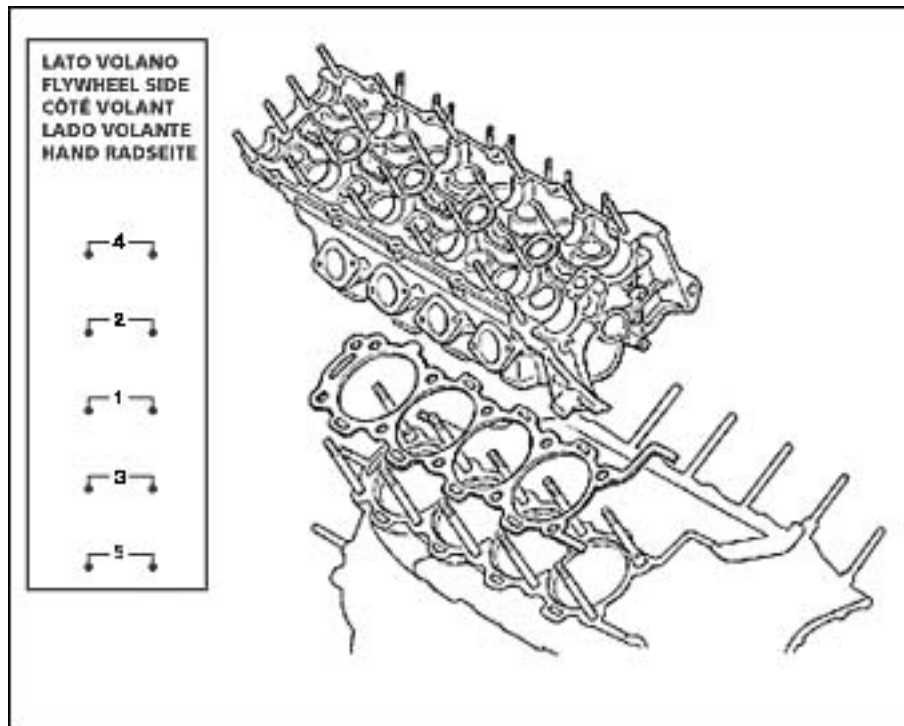

- Position the valve buckets.

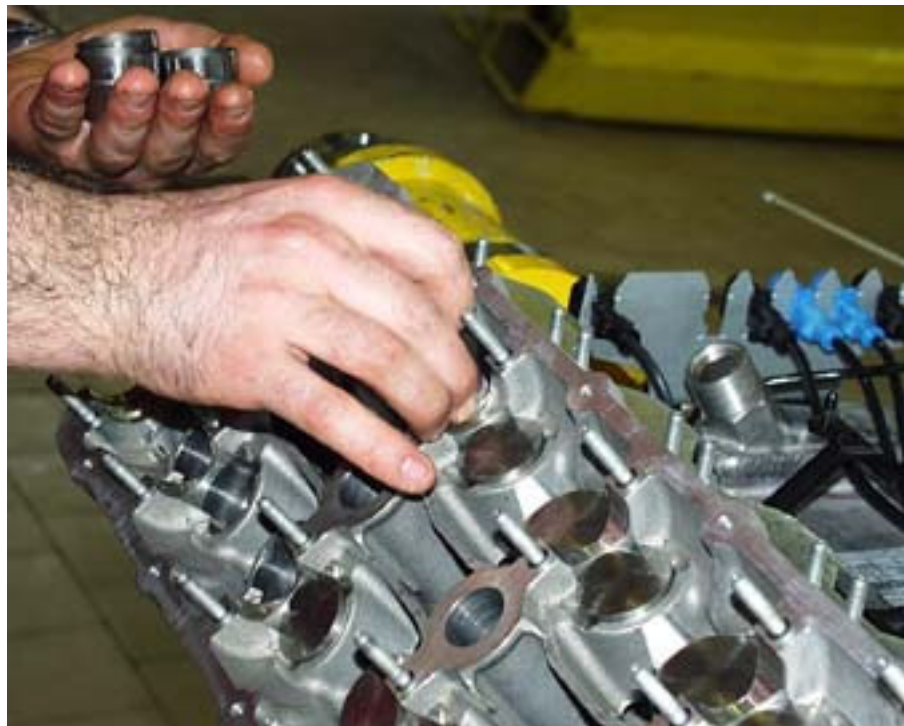

- Lubricate the camshaft mounts on the head.
- Make sure that the grommets are duly fit on the seat of the oil pump timing variators.



- Position the intake camshaft on the head, fitting the timing variator tab and positioning the oil pump timing variators in their seats.



- Position the exhaust camshaft and proceed with fitting the camshaft caps tightening them to a torque of **9 Nm** (the two nuts and the Allen screw of the first cap must be tightened to a torque of **10 Nm**).



- Position the protection filter (if it was removed) for the variator pressure control valve using tool **900026990**. Carry out this operation on both engine heads.



- Position the two 70x1.78 O-rings for the timing variator bushing. Perform this operation on both engine heads

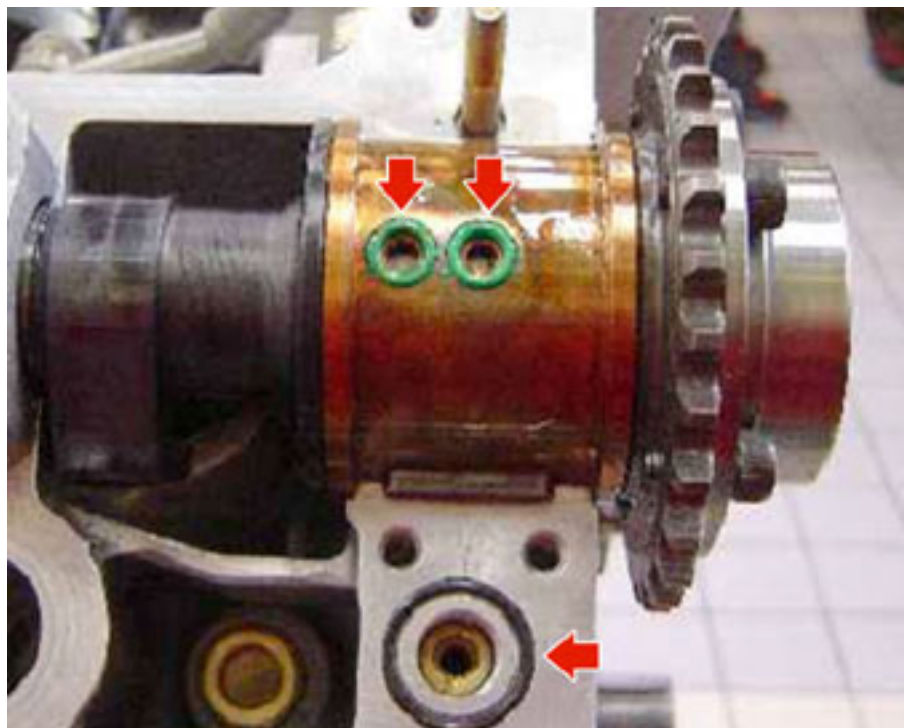

- Fasten the oil pump timing variators tightening the four Allen screws on the left-hand head and on the relative cap.



- Fit the timing variator solenoid valve, lubricate the mount and tighten the retaining screw to a torque of **10 Nm**.



- Fit the grommet for the timing control transmission mount into its seat.



- Fit the timing control transmission mount, tightening the fastening screws with Loctite 242 to a torque of **6 Nm**.



- If the pump assembly shaft bearing has been removed, refit it following the procedure described.
- Position the bearing centring template **900027040**.

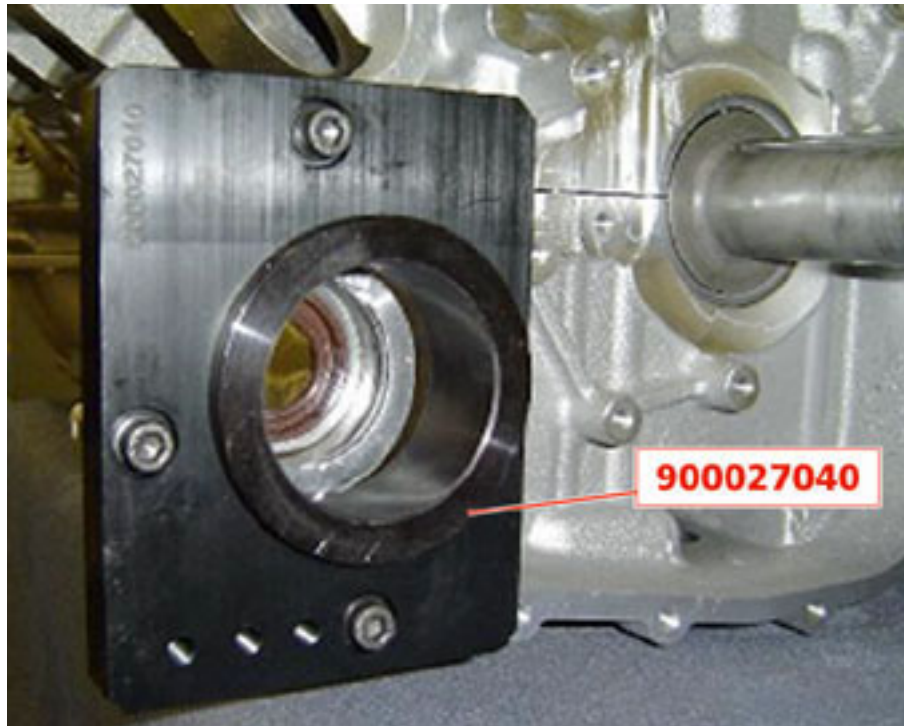

- Place the Ø 25-47x12 ball bearing on the fitting punch.



- Insert the punch into the template and bed in the bearing by tapping it with a plastic hammer.
- Subsequently check that the bearing has been fitted correctly.



- Fit the water/oil pump drive shaft in its seat.



- Using tool **900027030**, fit the pump drive shaft into place.

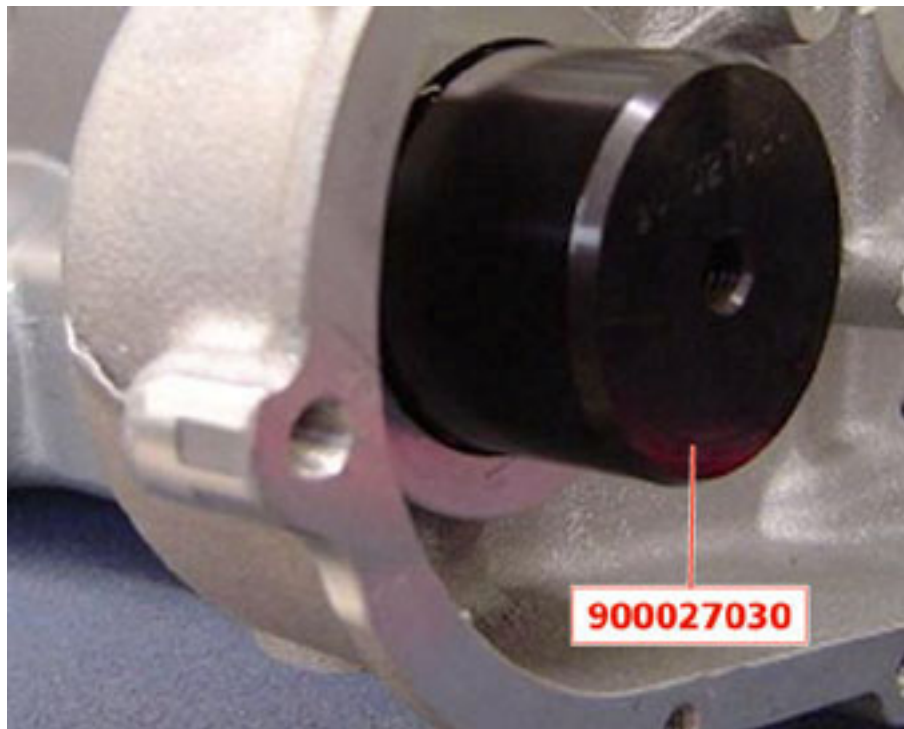

- Check the condition of the oil-water pump verifying that there is no leakage from the draining holes.



- Check the wear condition of the groove on the oil/water pump shaft.

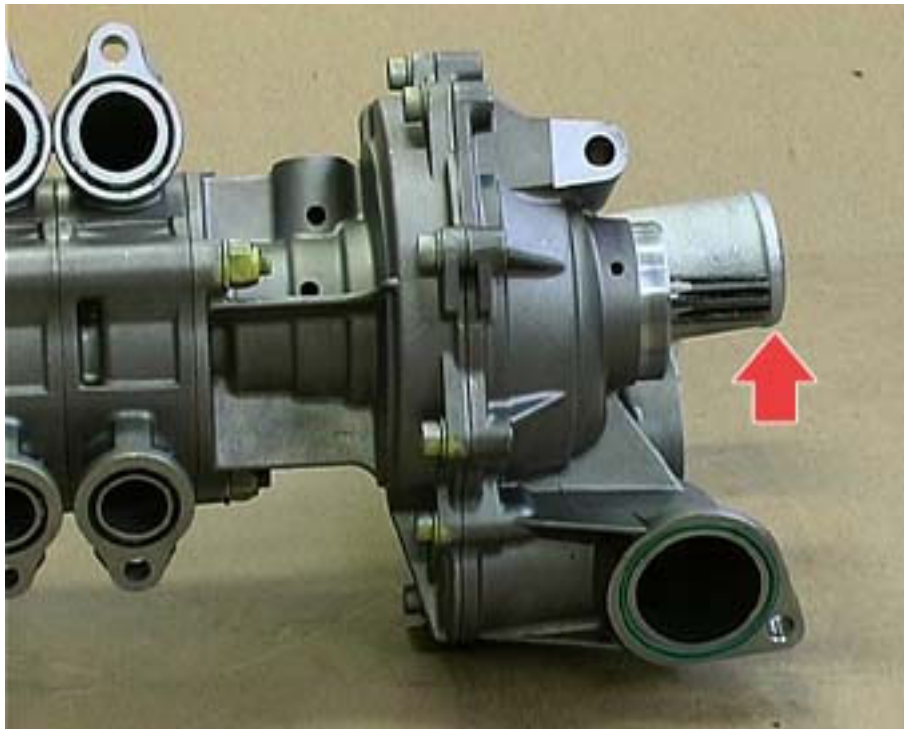

- Fit the balancing ring (1) and relevant Seeger ring (2) on the drive shaft (pump side).
- Fit the O-ring (3) (Figures 1 and 2) in the drive shaft seat.

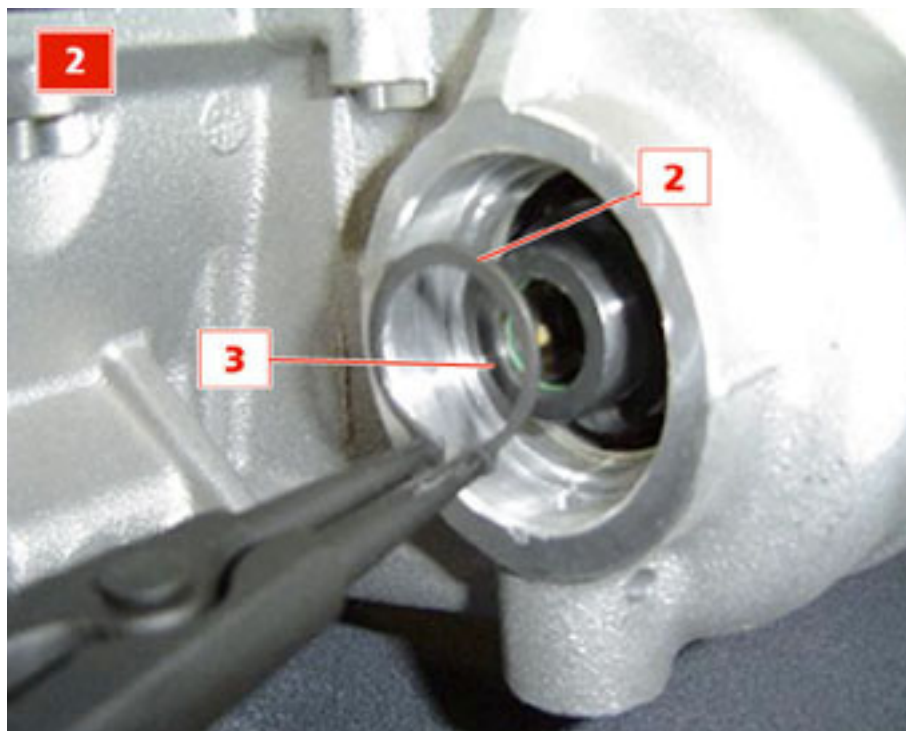
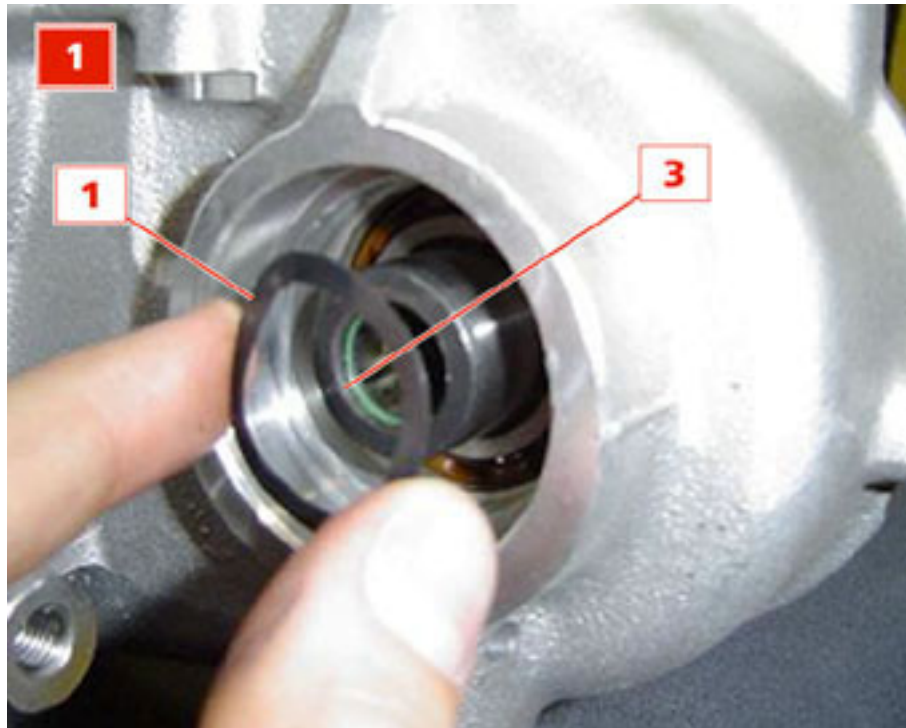

- Arrange tool **900027050** on the pump drive shaft to fit the oil seal.



- Fit the oil seal.



- Use the special punch to fit the grommet in its seat. Subsequently fit the balancing ring and the see ger ring which retains the bearing on the timing side.

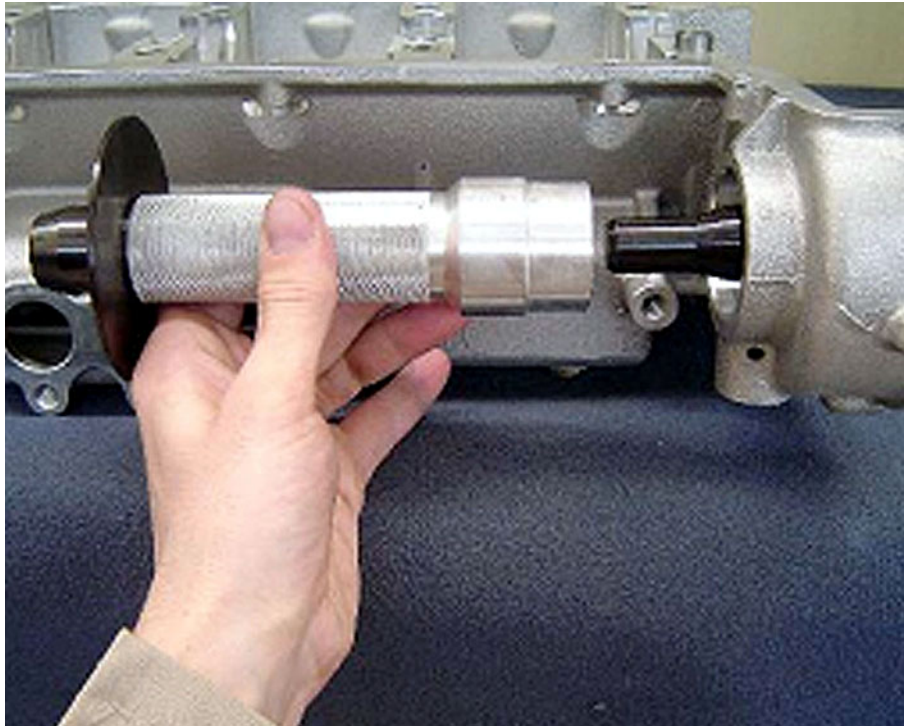

- Subsequently fit the balancing ring and the see ger ring which retains the bearing on the timing side.



- Lubricate the driving joint seat with Molykote 1000 grease.



N.B.

Always replace the pump OR.

- Lubricate the pump drive shaft with Molycote 1000 grease.
- Arrange the three O-Ring protection plates of tool **AV3602**.
- Fit the oil-water pump into its seat by inserting the shaft into the joint.
- Check that there are no signs of peeling of the O-rings in the area where the pumps join the crankcase. Fit the four M8X25 small headed screws to secure the assembly to the crankcase, the two M8X65 screws to secure the pumps to the lower part of the crankcase, and the three M8X25 screws to secure the pump to the crankcase, and at the same time remove the three plates **AV3602**.

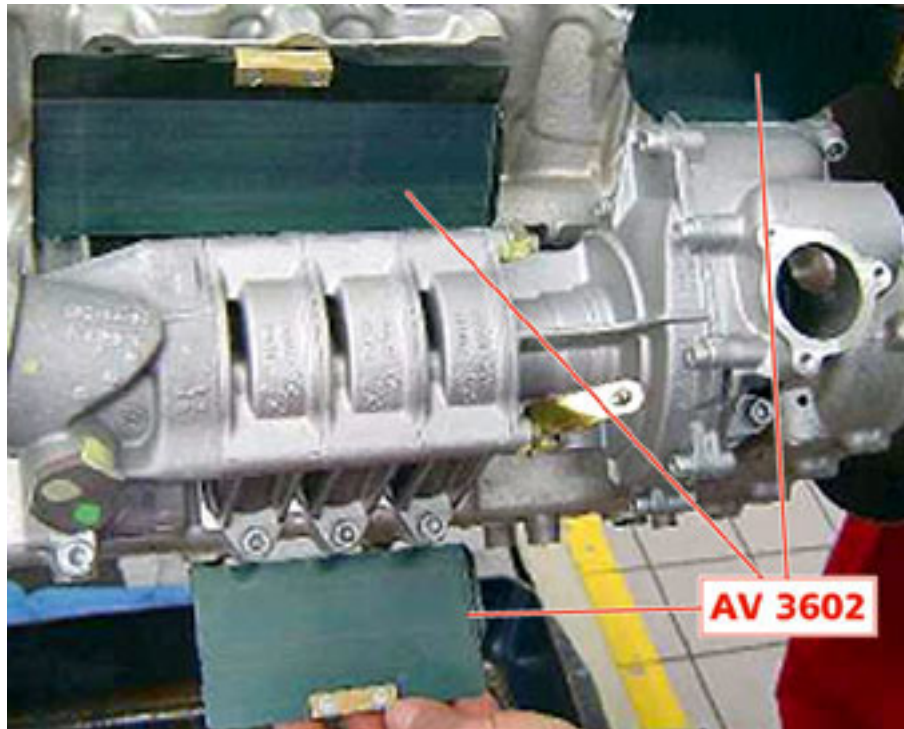

- Tighten the pump fastening screws to a torque of **25 Nm**.



- To fit the screws housed in the upper part of the pump assembly, use tool **900027150**.
- Use a torque wrench to tighten to a torque of **25 Nm**.



IMPORTANT:

The tightening torques for the chain runners are 10 Nm for the 6mm screws and 25 Nm for the 8mm screws.

- Install the mechanical tensioner for the transmission axle.



- Fit the transmission chain - toothed wheel unit onto the shaft using tool **AV3311**.



- Install the fixed runner and fit the shoulder, the balancing ring, the elastic pin and the Seeger ring.



- Install the fixed runner for oil-water pump control.



- Position the auxiliary pump chain on the toothed wheel for oil-water pump control and engage it with the crankshaft toothed wheel.



- Fasten the toothed wheel for oil-water pump control onto the oil-water pump driving joint, and tighten the fastening screws to a torque of **23 Nm**.

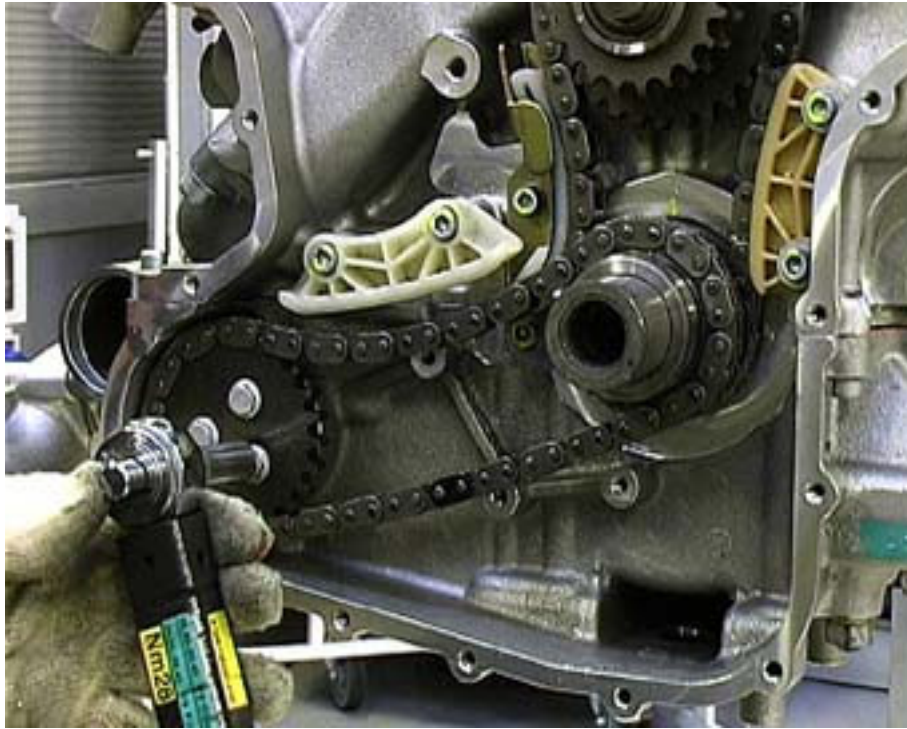

- Install the pump axle mechanical tensioner, tightening the fastening screws to the prescribed torque.

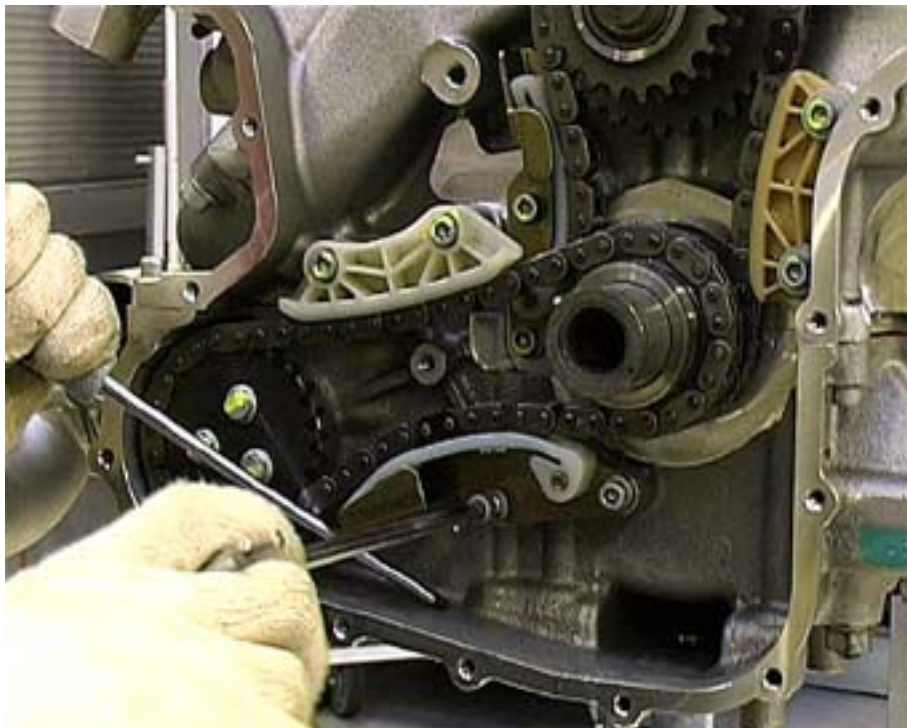

- Fit the elastic pin onto the transmission axle, insert the triple gearing shoulder support and the balancing ring.
- Fix the assembly with the see ger ring provided.

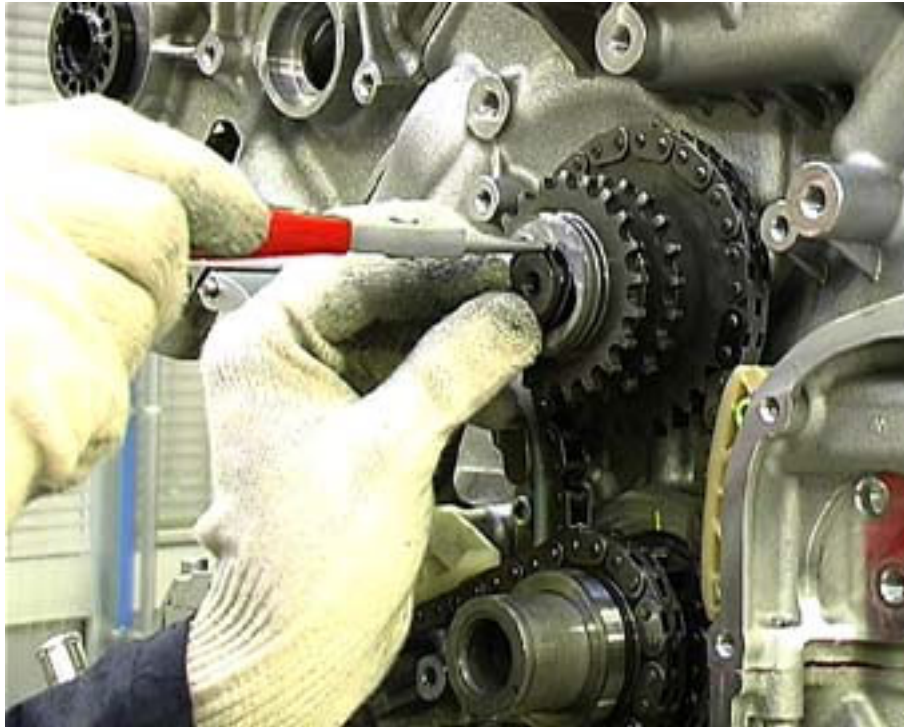

- Fit the fixed runners and the timing chain tensioners tightening them to the specified torque of **25 Nm**.
N.B.
To facilitate subsequent fitting of the camshaft drive chain, it is advisable to keep the two retaining screws of the RH fixed chain tensioner runner loose.

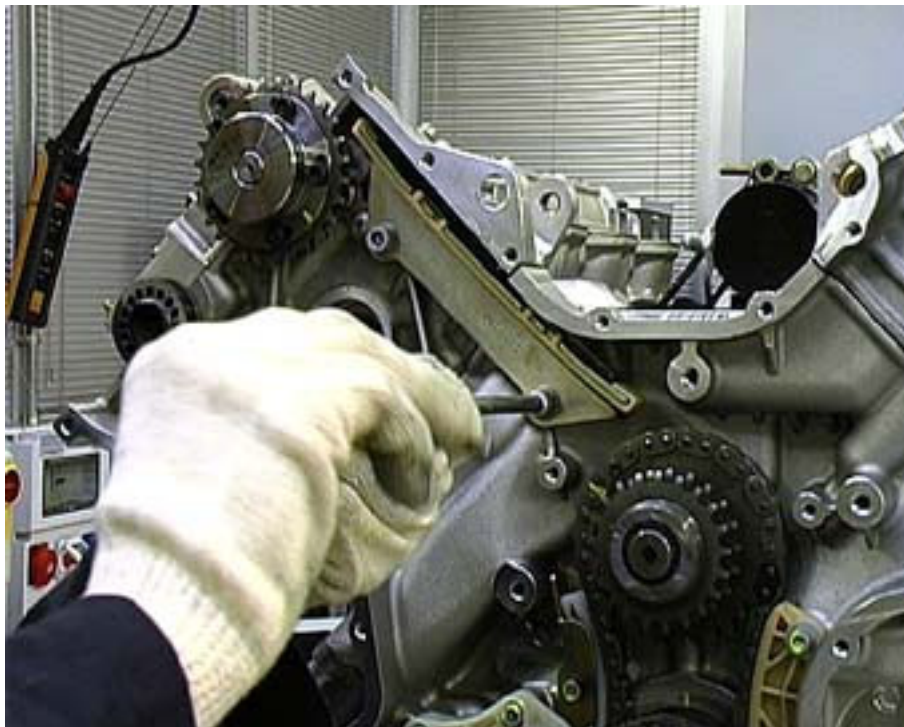

- Position the crankshaft so that the small wrench is at 45°, in order to prevent damaging the valves.



- Turn the camshafts of the two cylinder banks in such a way that the references at the ends of the shafts match the marks on the respective fixing caps. Lock the camshaft rotation.
- Having previously positioned all the pistons below the TDC, there is no risk of interference between the valves and the pistons during operation of the timing camshafts.

•

N.B.

Depending on the version, the camshafts may be differently machined so as to allow rotation during timing. The part number identifying the spare part is the same, but there may be a hexagon on the camshaft for positioning a fixed wrench, or an opening machined to host a wrench, or a hole to position a cylindrical punch.

IMPORTANT

At this point in the assembly procedure, the engine timing must be checked or restored.

- Move the camshafts to align the reference marks on the heads with those on the shafts themselves (Figures 1, 2 and 3).

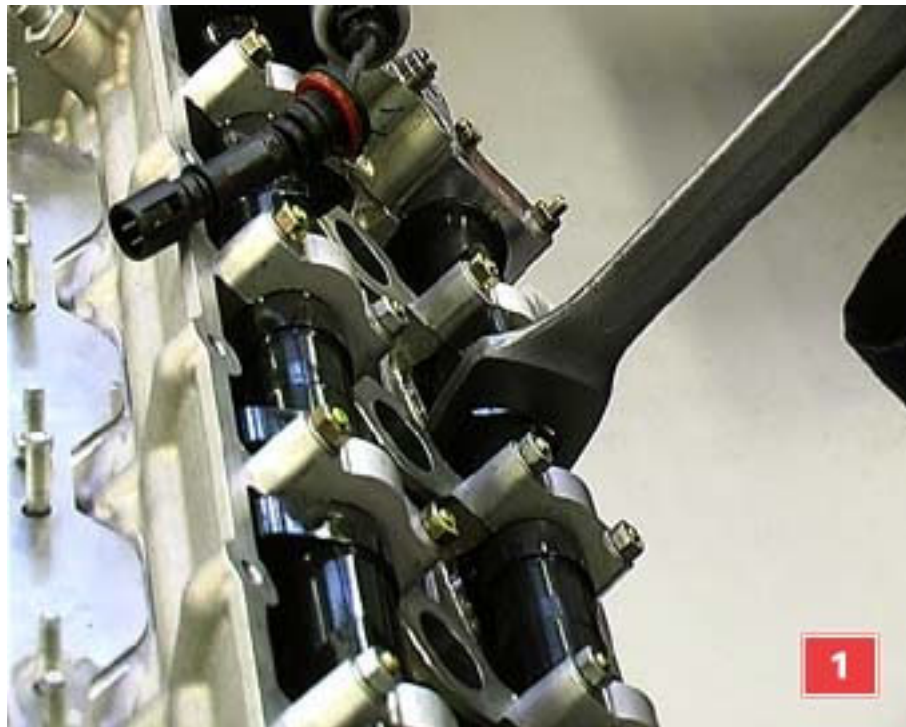

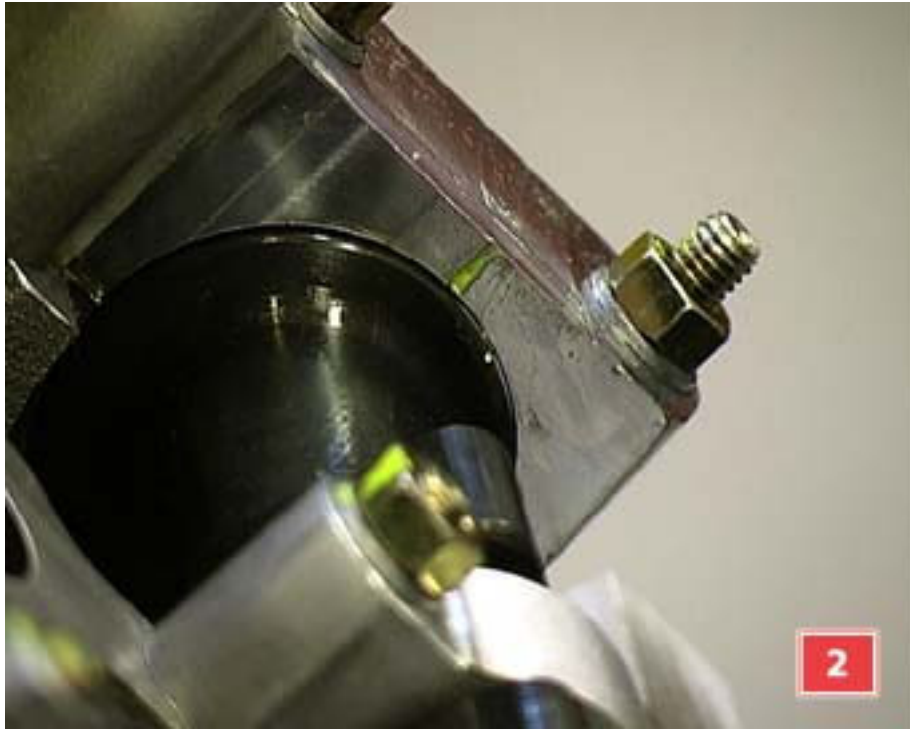

- Fit the centesimal dial gauge with its holder **CS104488**, screwing it into the spark plug hole of the first cylinder.
- Position the goniometer and turn the crankshaft until reaching the **TDC**



- Position the camshaft drive chain on the right-hand cylinder bank. Position the chain on the innermost gear of the crankshaft.

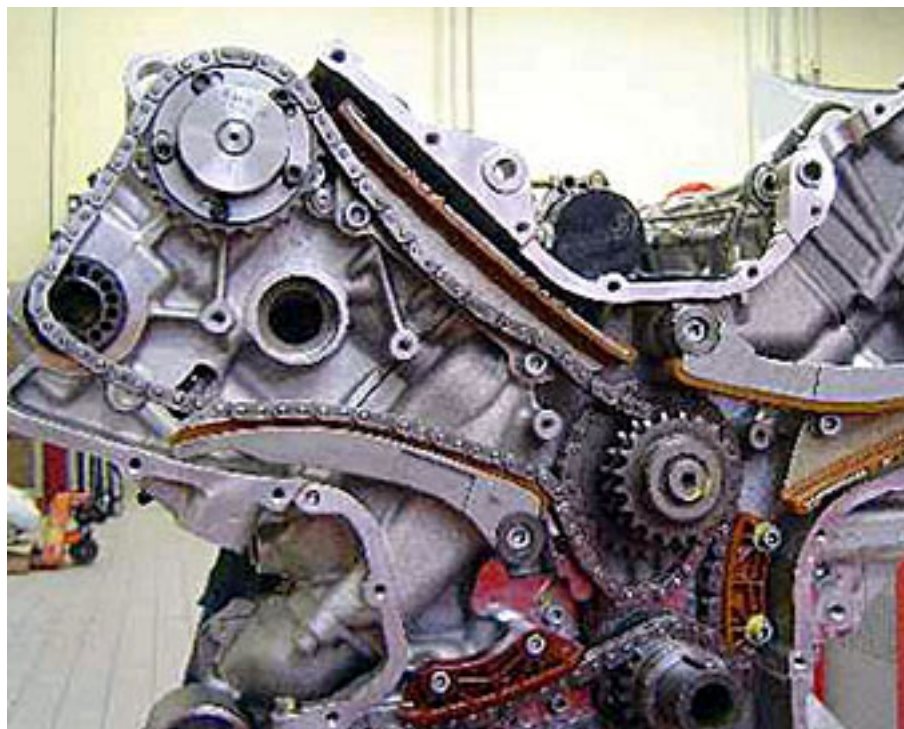

- When fitting the chain, loosen the screws on the timing variator of the right-hand and left-hand cylinder bank.
- Position the adjustment slots in the centre of the available adjustment range, so that play can be recovered during timing adjustment. Tighten at least two retaining screws on the variator.
- After positioning the timing chain on the engine, tighten the two retaining screws of the right-hand fixed chain tensioning runner to a torque of **25 Nm** using a torque wrench.



- Fit the gearwheel for the exhaust camshaft. Position the centring dowel into the first free hole available, after coupling the gearwheel onto the camshaft.



- Check that the pointer of the dial gauge fitted on the holder **CS104488** always indicates the TDC position.



- Fit the hydraulic chain tensioner and use a torque wrench to tighten to a torque of **70 Nm**.

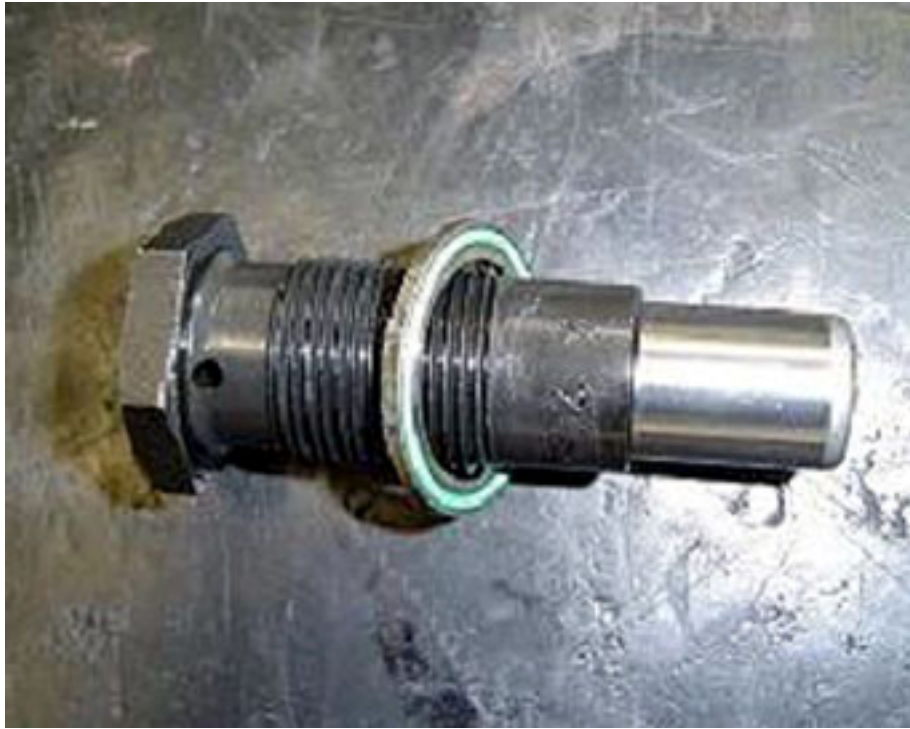

- Repeat the operation for the left-hand cylinder bank.
- When the assembly procedures have been completed, check the TDC position with the dial gauge.



- Screw down by hand, without tightening, the two retaining screws for the exhaust camshaft gearwheels.



- Position the hydraulic chain tensioner together with the gasket on the left-hand cylinder bank using two screws with washers.
- Use a torque wrench to tighten the two screws to a torque of 10 Nm.
- Use a torque wrench to tighten the tensioner screw to a torque of 40 Nm

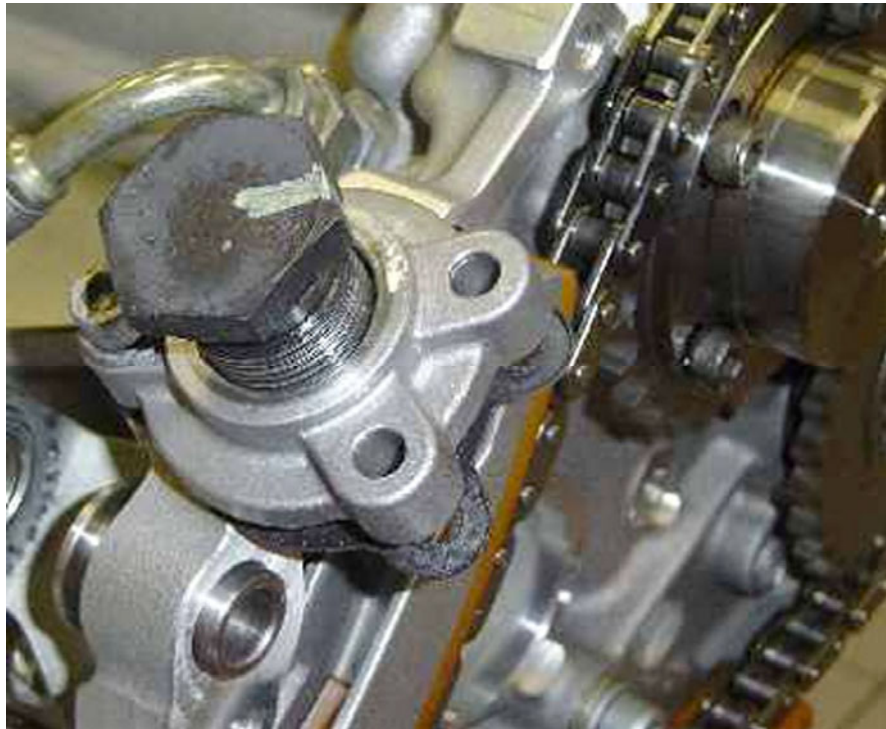

- Release the camshafts.
- Turn the engine anticlockwise and check that there is no interference.



ADJUSTING THE INTAKE SHAFT TIMING

- Turn the engine anticlockwise and position the first piston at the TDC. Make sure that the dial gauge is on zero.
- Place a support for the magnetic base of the dial gauge holder on the right-hand engine head.
- position a magnetic base with a long-rod centesimal dial gauge.
- Turn the engine clockwise positioning the intake cam immediately before the opening ramp. In this condition, the hydraulic tappet is still in the rest position.
- Position the dial gauge plunger above the tappet of an intake valve. The dial gauge rod must be as perpendicular as possible to the tappet surface.



- Reset the dial gauge that measures the movement of the intake tappet.
- Go back to the TDC position and check the dial gauge previously reset. In this position (TDC), the intake valves of the first cylinder have already started their travel. Therefore, carefully check the position on the dial gauge positioned on the tappet.
- Turn the crankshaft **15°** beyond the TDC. This corresponds to a piston stroke of **1.75 mm** beyond the TDC.
- Check that the tappet downstroke (begun before the TDC) and hence the intake valve upstroke is **0.59±0.08 mm**.
- Should the values measured in these conditions be out of tolerance, hold the crankshaft still, loosen the screws on the timing variator and turn the intake camshaft until obtaining the desired intake valve upstroke. For this reason, as described earlier, it is advisable to get ready for the timing procedure by positioning the variator adjustment slots in the centre of the angular adjustment.
- Check the timing again.
- Use a torque wrench to tighten the previously loosened screws that secure the variator to a torque of **15 Nm**, after applying Loctite 242.



Intake data summary.

Beginning before TDC **15°± 1**

End after TDC **66°± 1**

ADJUSTING THE EXHAUST SHAFT TIMING

- Turn the engine clockwise and position the first piston at the TDC with the camshafts balanced (exhaust closed and intake open). Make sure that the dial gauge is on zero.
- Position the dial gauge plunger on the tappet of an exhaust valve. The dial gauge rod must be as perpendicular as possible to the tappet surface.
- Reset the dial gauge that measures the movement of the exhaust tappet.
- Turn the crankshaft clockwise until an exhaust valve is closed.
- Check that the tappet downstroke and hence the exhaust valve upstroke is **0.57 ± 0.08 mm**



- Should the values measured in these conditions be out of tolerance, hold the crankshaft still, move the centring dowel anticlockwise or clockwise (depending on whether you wish to delay or advance the shaft) until obtaining the desired timing value.
- Fit the retaining dowel **(1)** in the hole immediately after or before the centring dowel, whatever is easier.

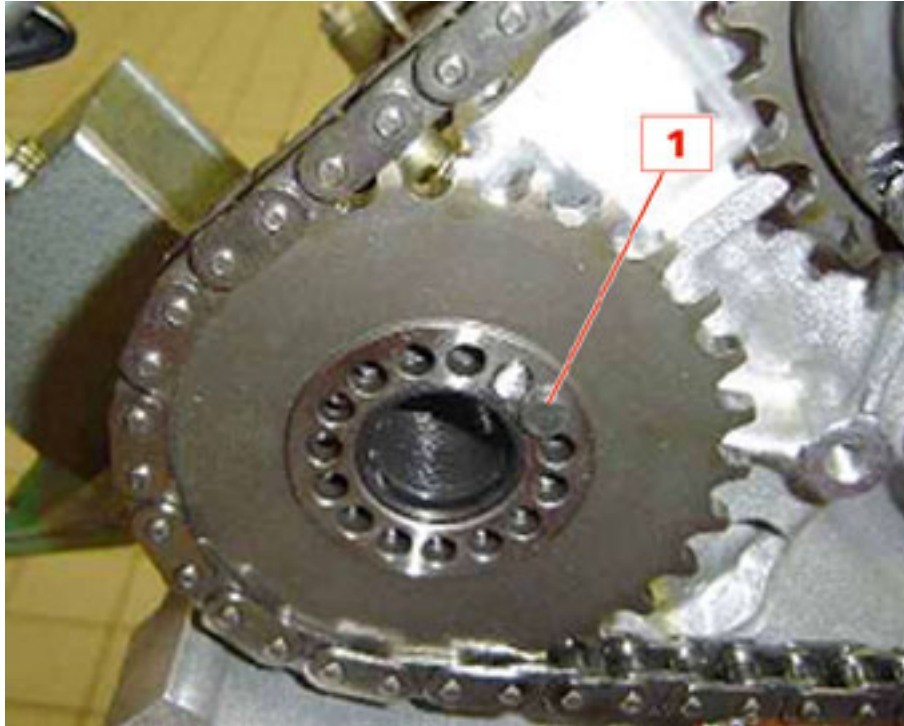

- To complete the operation, fix the exhaust camshaft gearwheel.

N.B.

Use engine oil to lubricate the thread and underhead of the retaining screw on the exhaust camshaft and the toothed ring gear.

- Tighten the retaining nut with sealing washer to a torque of **200 Nm**.
- During the procedure, lock the camshaft by working on the handling hexagon in such a way as not to load the timing belt.
- Perform the same procedure for the left-hand cylinder bank, positioning the dial gauge holder in the seat of the spark plug of cylinder number 8.



N.B.

After adjusting the timing, it is advisable to perform an OIL PRESSURE TEST, introducing pressurised engine oil through the oil filter union at a pressure of 5-6 bar. In this way, you can check the lubrication of the camshaft seats, hydraulic chain tensioners, tappets and central transmission pin.

Exhaust data summary.

Beginning before BDC $15^{\circ} \pm 1$
End $0^{\circ} \pm 1$

- Fit the upper runner and tighten the retaining screws to a torque of **10 Nm**



- With the aid of short stud bolts, position the gaskets on the crankcase.



- Lubricate the seats of the cooling circuit grommets.



- Fit tool **900026590** onto the crankshaft, in such a way that the oil seal will not be damaged when the cover is installed.



- Install the front crankcase cover.



- Replace the stud bolts together with the fastening screws.



- Tighten the front cover screws to a torque of **10 Nm**.



- Fit the belt tensioner paying particular attention to the position of the reference pin, and tighten to a torque of **25Nm**.



- Fit tool **900026560** to lock the crankshaft rotation.



- Position the torsion damper on the shaft and tighten the fastening screw with Loctite 242 to a torque of **450 Nm**.



- Fit the hydraulic steering pump, tightening the front screw to a torque of **10 Nm (Figure 1)** and the rear screw to a torque of **25 Nm (Figure 2)**.



- Secure the air-conditioning system compressor by tightening the screws to a torque of **25 Nm**.



- Insert the bushings to fasten the alternator onto the crankcase.



- Fit the alternator by tightening screw **A** to a torque of **49Nm** and screw **B** to a torque of **59 Nm**.

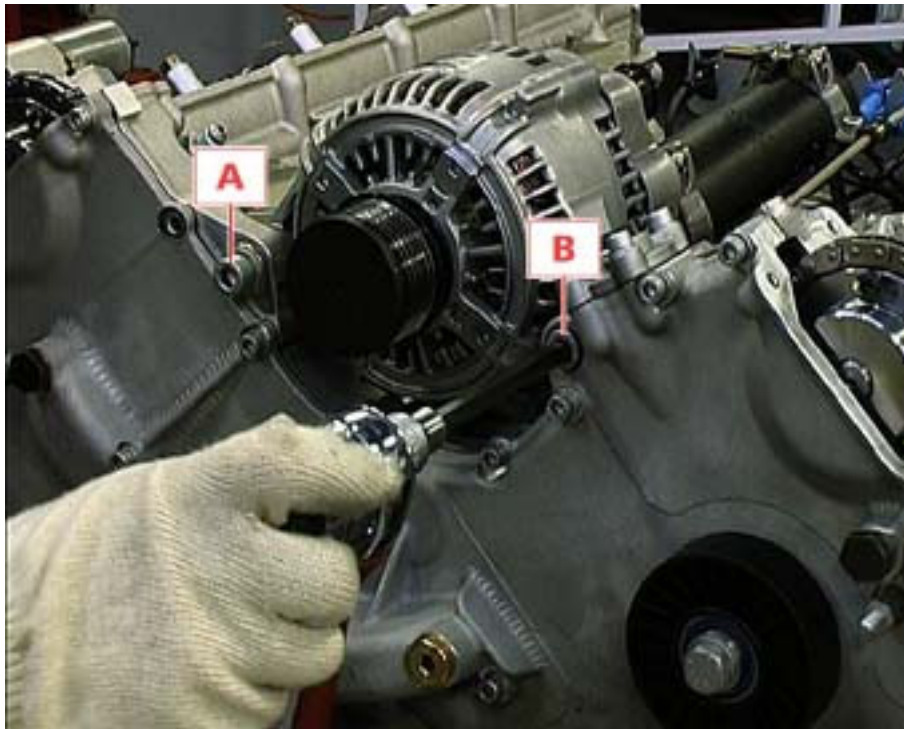

- Turn the movable tensioner and fit the multifunctional belt.



- Fit the engine mounting brackets and tighten the retaining screws to a torque of **53 Nm**.

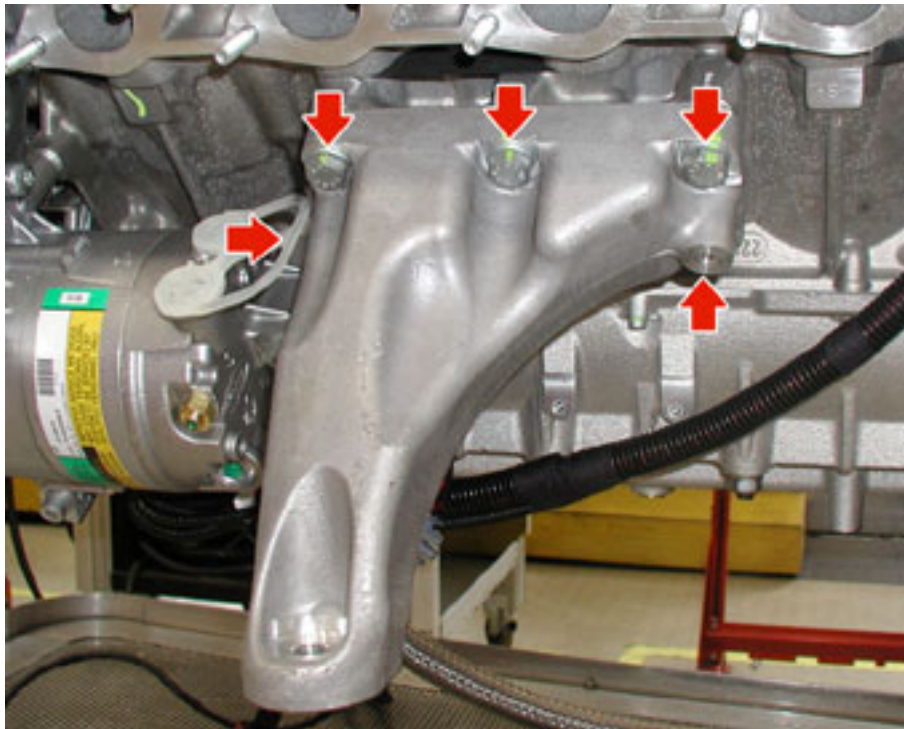

- Install the starter motor, tightening the fastening screws to a torque of **14 Nm**.



- Fit the spark plugs after having lubricated the threading with Champion 2612 grease.



- Fit the tappets' cover remembering to arrange the head gaskets and the spark plug tube gaskets beforehand. Insert the timing variator connector through the specific hole.



- Working from the middle outwards, tighten the closing screws to a torque of **10 Nm**.



- Fit the Seeger ring for the cable guide of the timing variator valve using tool **AV3333**.



- Fit the ignition coils (**Figure 1**) and tighten the retaining screws to a torque of **10 Nm** (**Figure 2**).

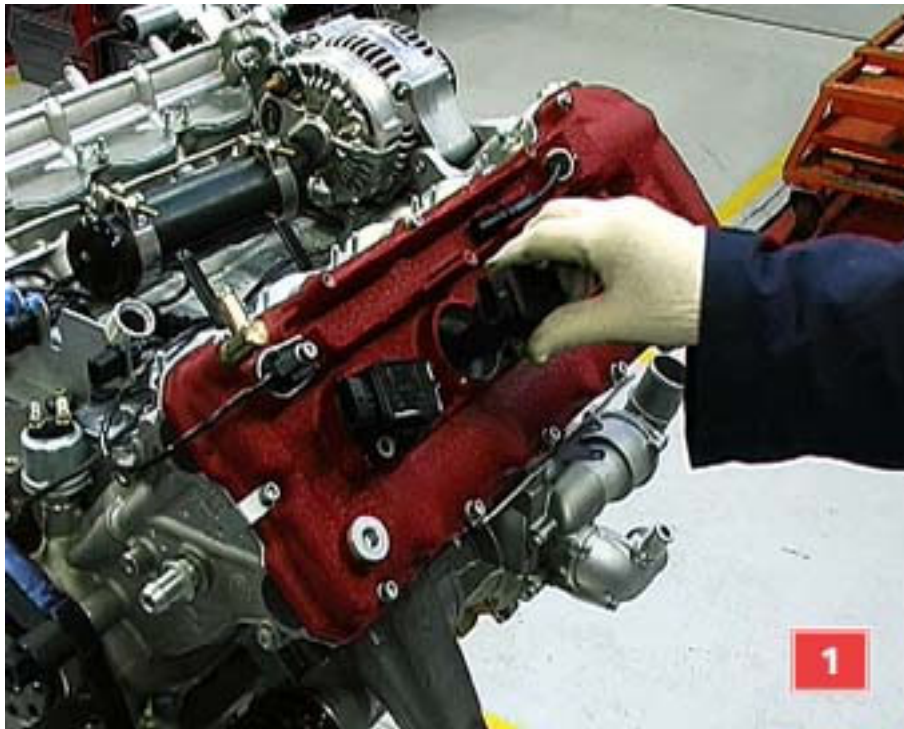

- Working from their housings on the support bracket, take out the connectors of the timing sensors (RH and LH), the rpm sensor (RH) and the detonation sensors (four).

CAUTION

Check that the sensors on each wire match, consulting the electric system manual if necessary.



- Install the tubes which run from the accumulators to the timing variator solenoid valves.

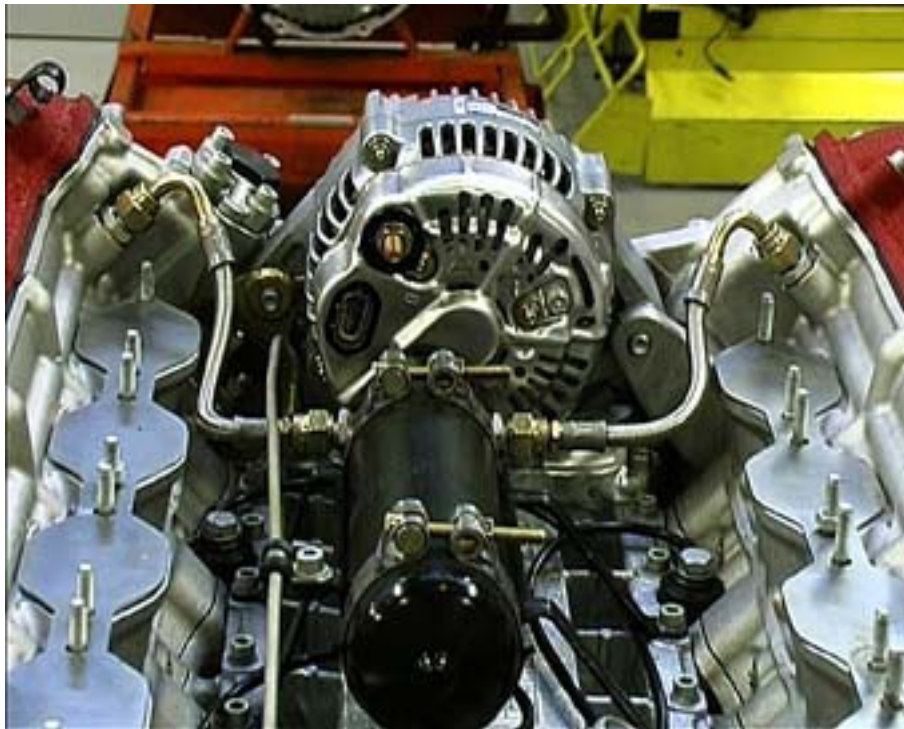

- Fit the tube which runs from the exchanger to the tank. Fit the fastening nut onto the exchanger and secure the retaining bracket.



- Complete the procedure by tightening the nut on the exchanger to a torque of **75 Nm**.

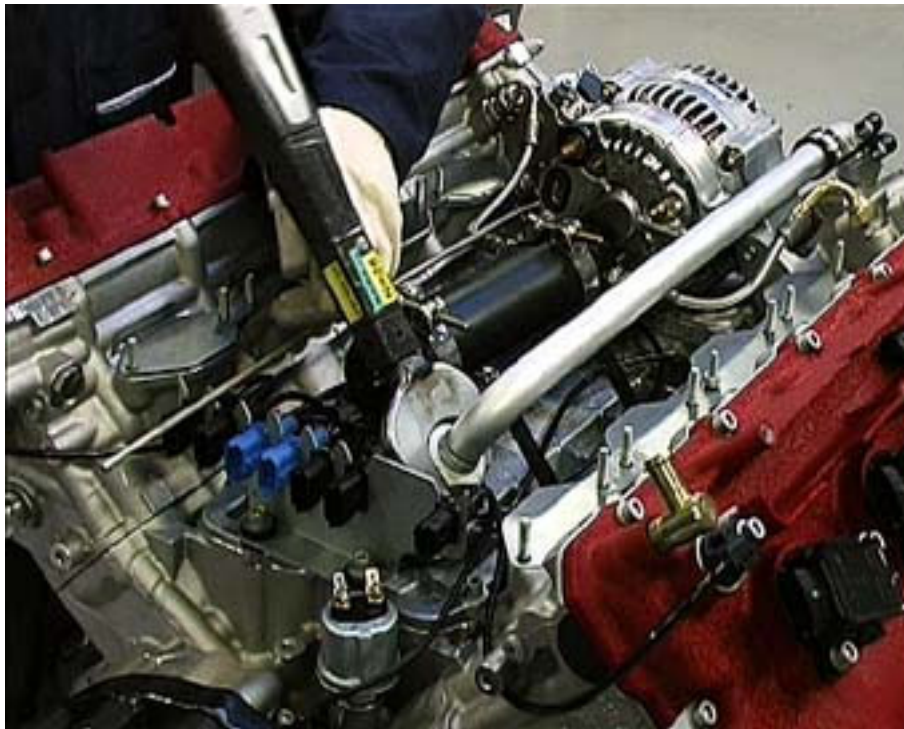

- Secure the service wire onto the alternator and tighten it to a torque of **10 Nm**.



- Using a clamp, secure the injection cable onto the right-hand head.



- Using a clamp, secure the wiring leading to the head coils and the wiring leading to the injectors and the fuse box.



- Fit the connector onto the alternator.



- Secure the earth terminal onto the crankcase, tightening the fastening screw to a torque of **25 Nm**.

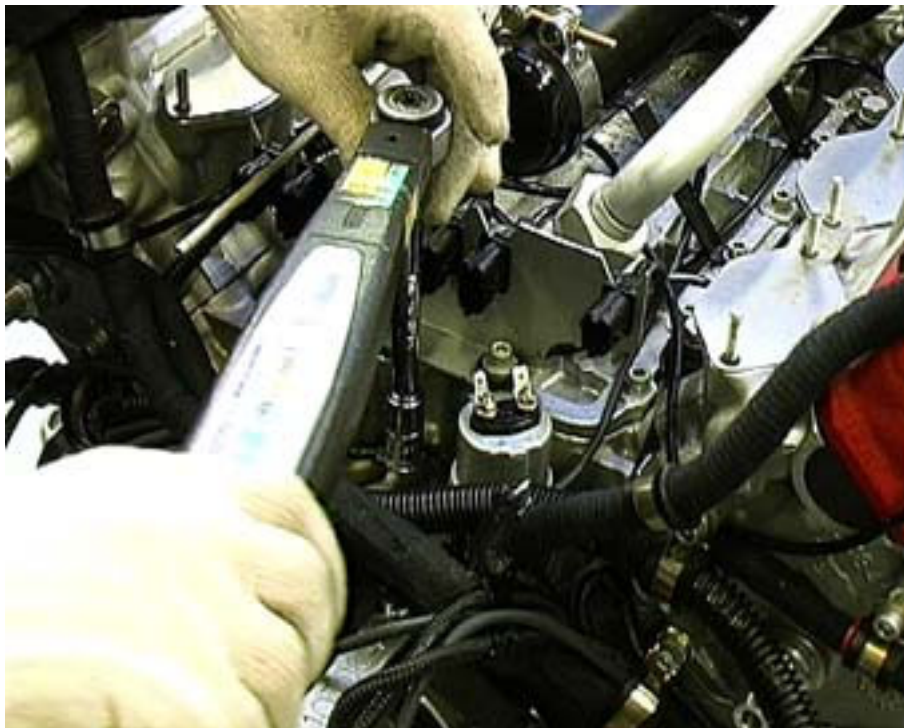

- Attach the connectors to the wiring support bracket.



- Connect the oil pressure sensor.



- Secure the wire which leads to the A/C compressor and to the starter motor.



- Remove the tools **AV3332** protecting the intake ducts and position the gasket on the manifolds.



- Position some pins (1) in the holes on the ends of the intake ducts for reference and centring of the intake manifold.



- Position the intake manifold, centring it on the duct's stud bolts.



- Remove the pins used for centring .
- Tighten the bolts to a torque of **10 Nm**.



- Connect the wiring leaving from the motor-driven throttle.

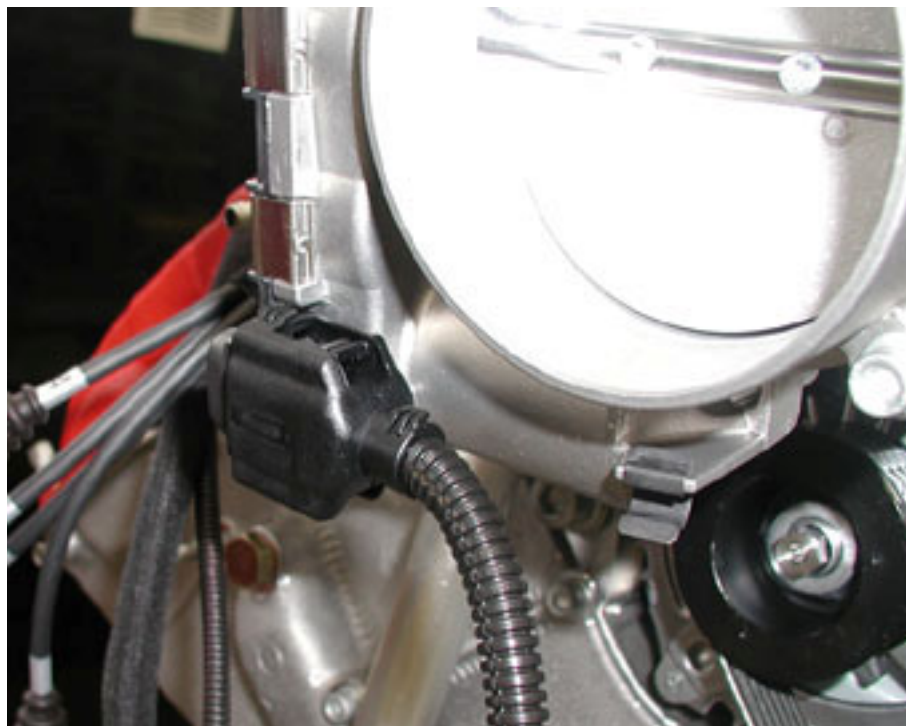

- Before refitting, replace the seal of the electro-injectors.



- Fit the fuel manifold complete with electro-injectors (1).
- Attach the electrical connectors of the electro-injectors (2) and tighten the nuts (3) to a torque of 15 Nm.

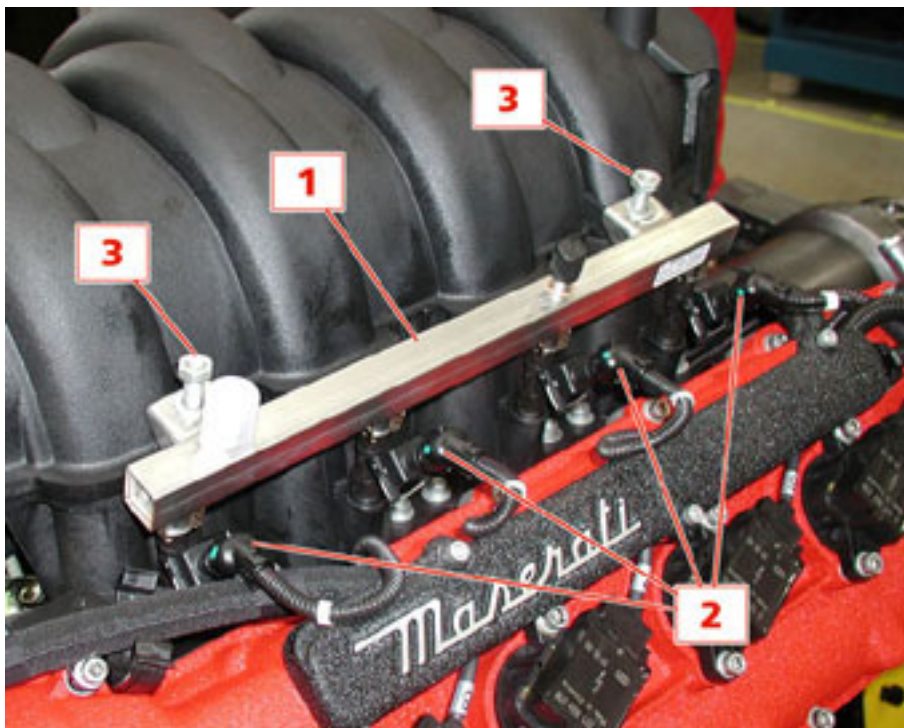

- Connect the flexible hose to the rigid pipe.



- Fit the line support bracket (1) and connect the flexible hose (2) complete with fastening clamp; screw on the nut (3).
- Tighten the nut (4) of the line support bracket.

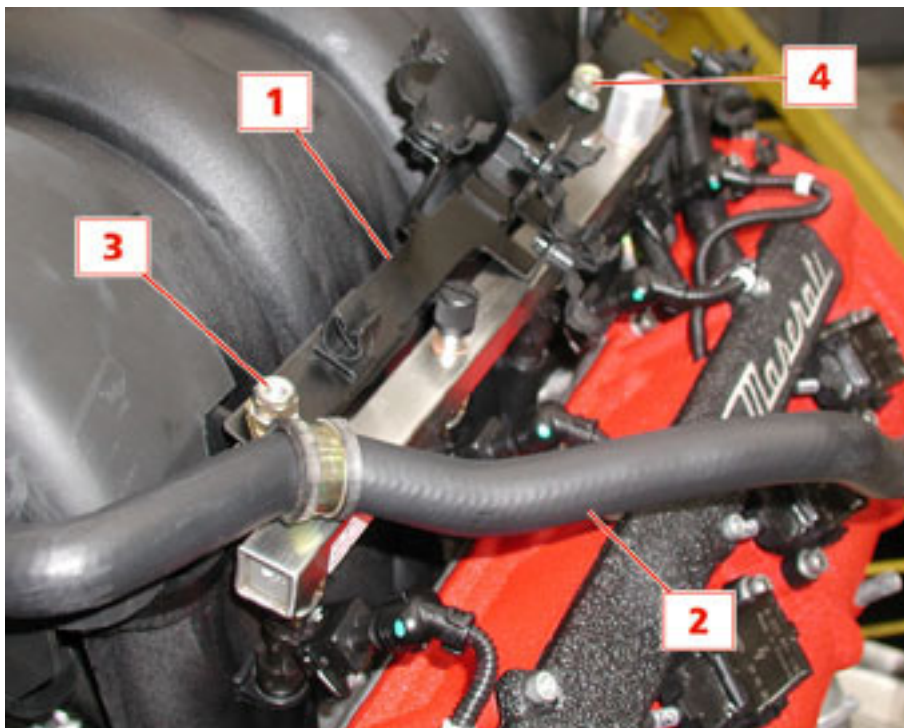

- Connect the vapour recirculation line (1) to the tappet cover of the left-hand cylinder bank.

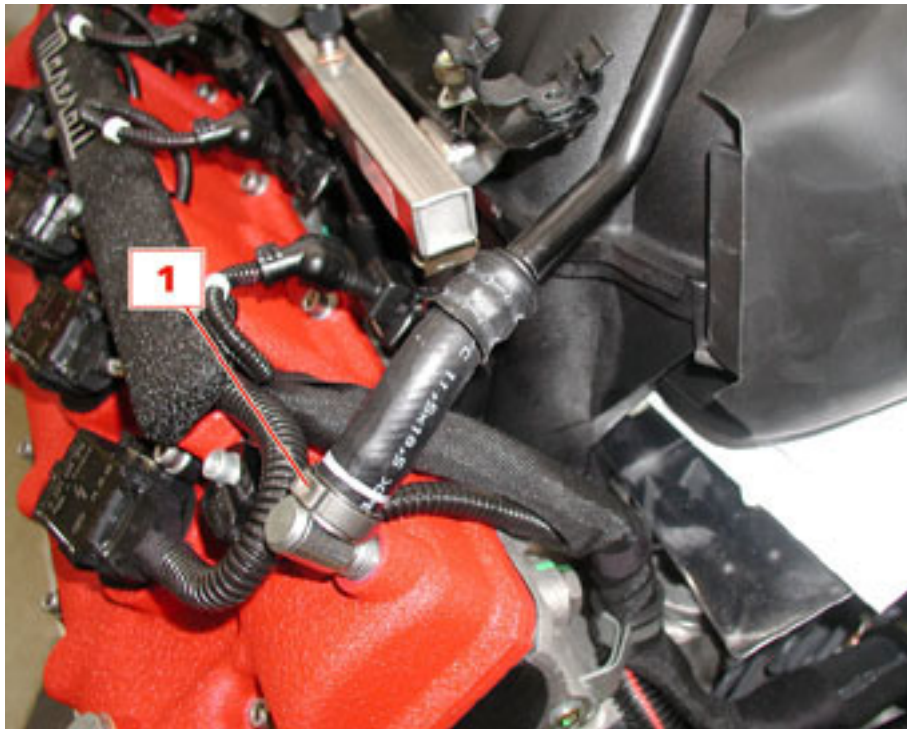

- Connect the vapour recirculation line (1) to the tappet cover of the right-hand cylinder bank.

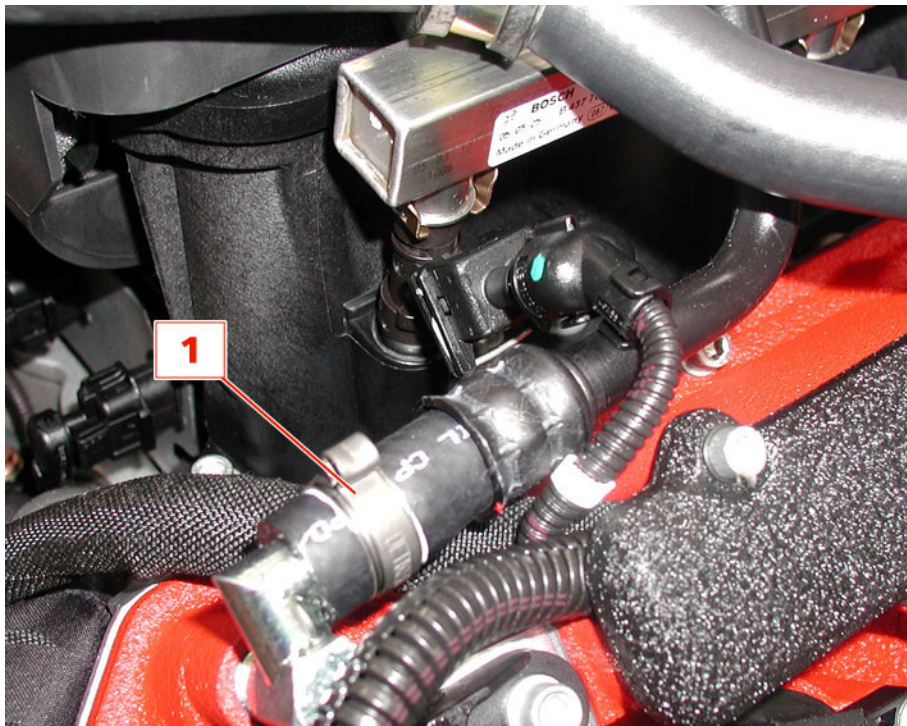

- Lock the two fastening clamps (1) of the vapour recirculation line.



- Using tool 900026550, insert the clutch shaft support bearing.



IMPORTANT

Once the engine assembly procedure is complete, check that the wiring is correctly positioned, consulting the electric system manual if necessary.

DIMENSIONAL CHECKS

Checking the camshaft dimensions

- Check that the main bearing journals and the cams do not show scoring or excessive wear.



- Measure the main bearing journals with the micrometer.



- The dimensions measured must fall within the indicated values (**Figure 1 e 2**)..

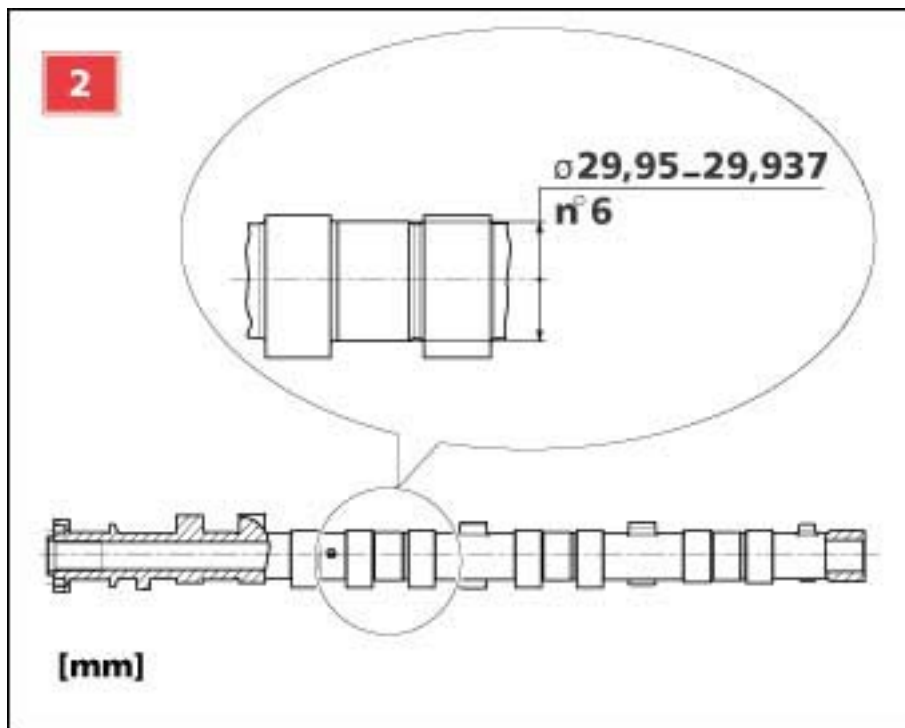
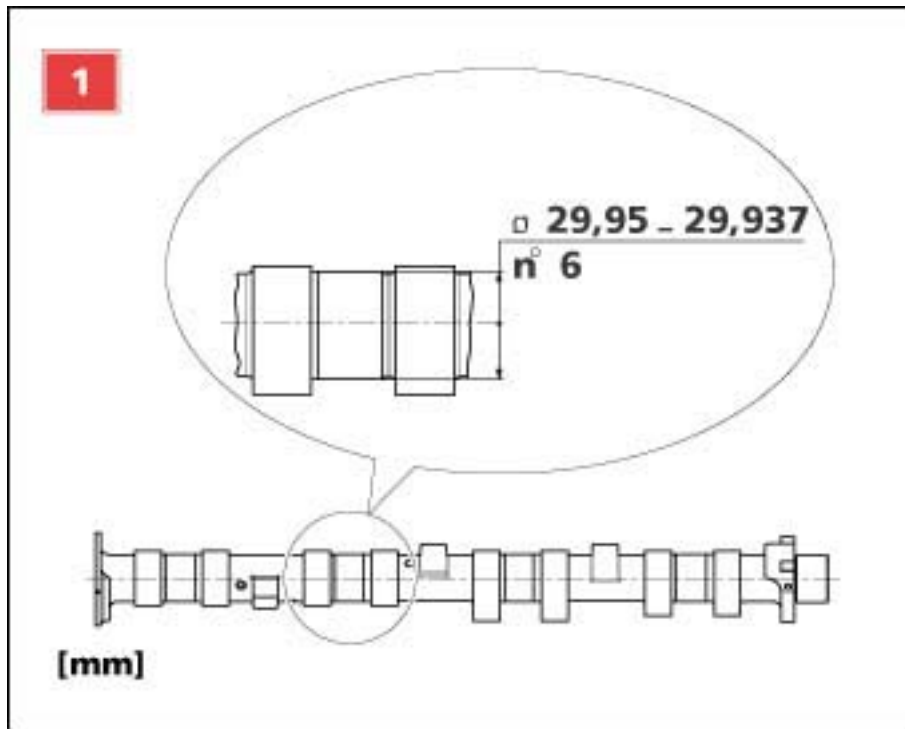

N.B.

To check the coaxial factor of the main bearing journals, a checking plane is required.

- Place the camshaft on the indicated tool. **AV3135**.
- Reset the dial gauge on the main bearing journal to be examined and rotate the shaft checking the dial gauge indication.
- The coaxial factor error detected must be lower than the prescribed value.



- Repeat the operation for the marked journals.

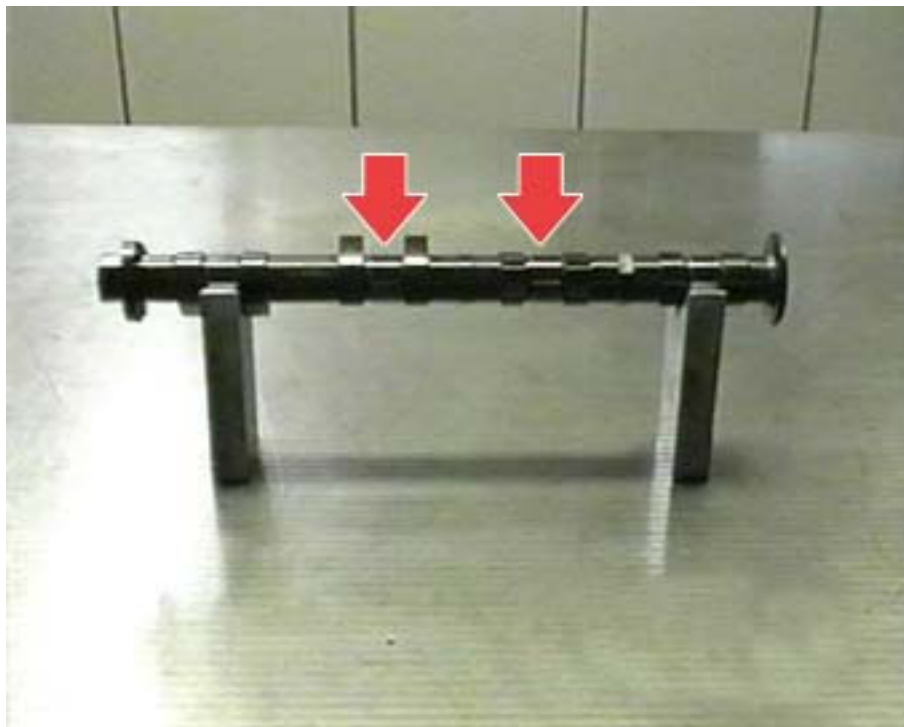

Piston dimensional check

- Carry out a careful visual check of the skirt checking that there is no scoring or excessive wear.



- Measure the piston diameter taking three measurements at the reference heights.



- The dimensions detected must fall within the indicated values.
- In addition, check the pin seat diameter, which must be $20+0.011+0.005$ mm, and the pin outer diameter, which must be $20 - 0.005$ mm.

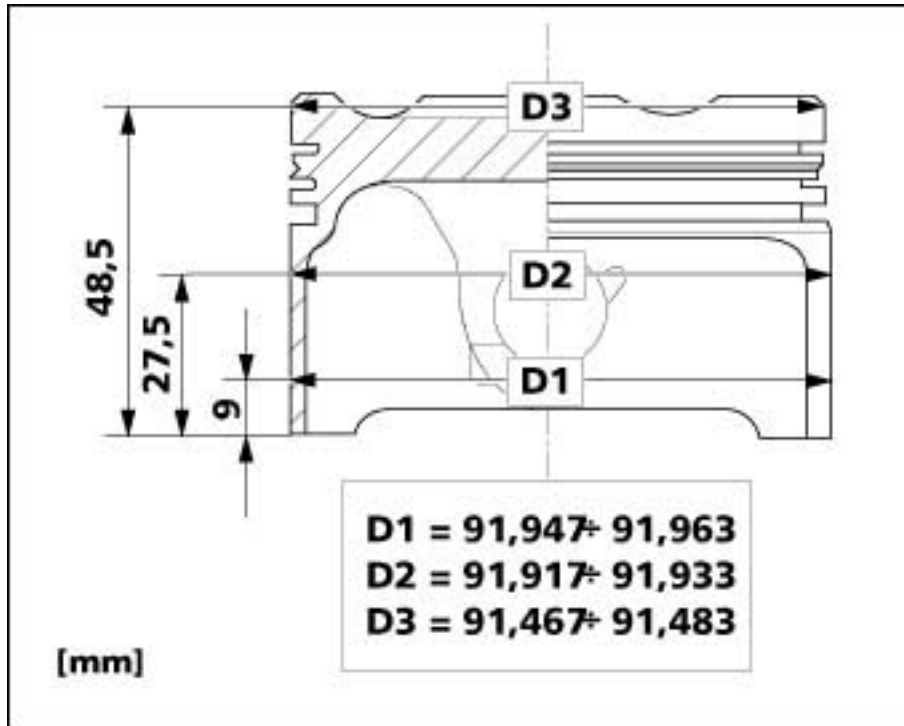

IMPORTANT

The pin hole is **NOT** symmetrical with the piston axis.

The reason for this offset is the need to limit the lateral forces that are perpendicular to the cylinder liner. The offset follows the rotation direction of the crankshaft and, for this reason, the RH bank pistons are different from those on the LH cylinder bank.

- After removing the grommets from the piston, carefully inspect them. In the event of scoring, cracks or signs of abnormal wear, they must be replaced.

IMPORTANT

There is no specific fitting direction for the oil scraper ring, nonetheless, take care at the joint of the internal clip: do not position it on the upper and lower ring opening.

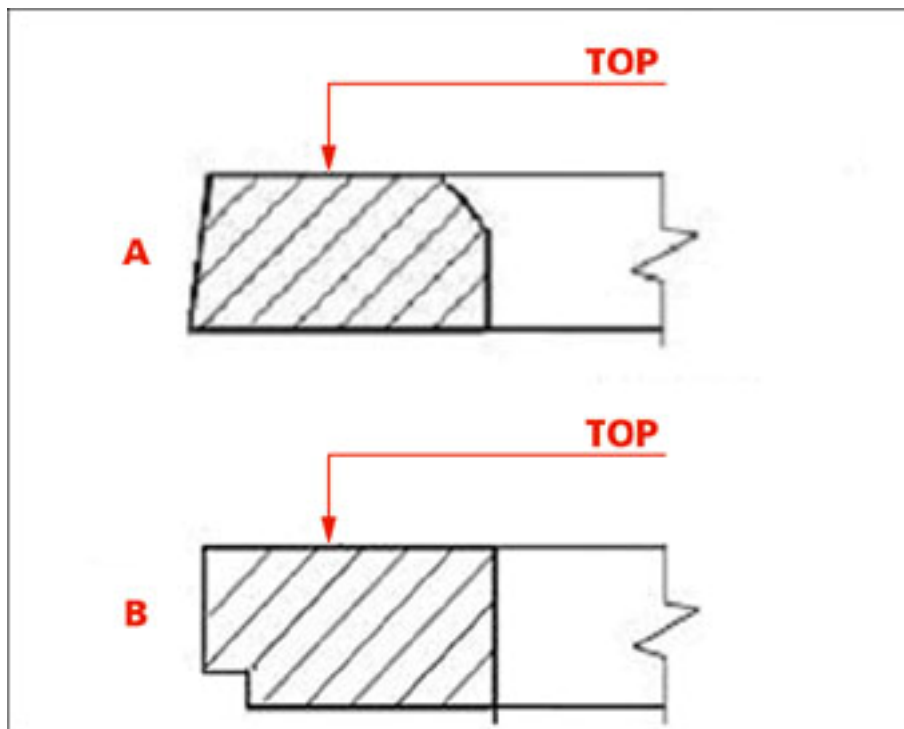

Connecting rods dimensional check

N.B.

All checks of the connecting rods must be carried out with used screws.

- To measure the diameter of the connecting rod big end, reset the bore-meter on tool **ALZ F04702**.



- Using a torque wrench, tighten the fastenings on the connecting rod big end to torque.
- Check the diameter of the connecting rod big end taking two measurements at a distance of 90°.



- The dimensions detected must fall within the indicated values.

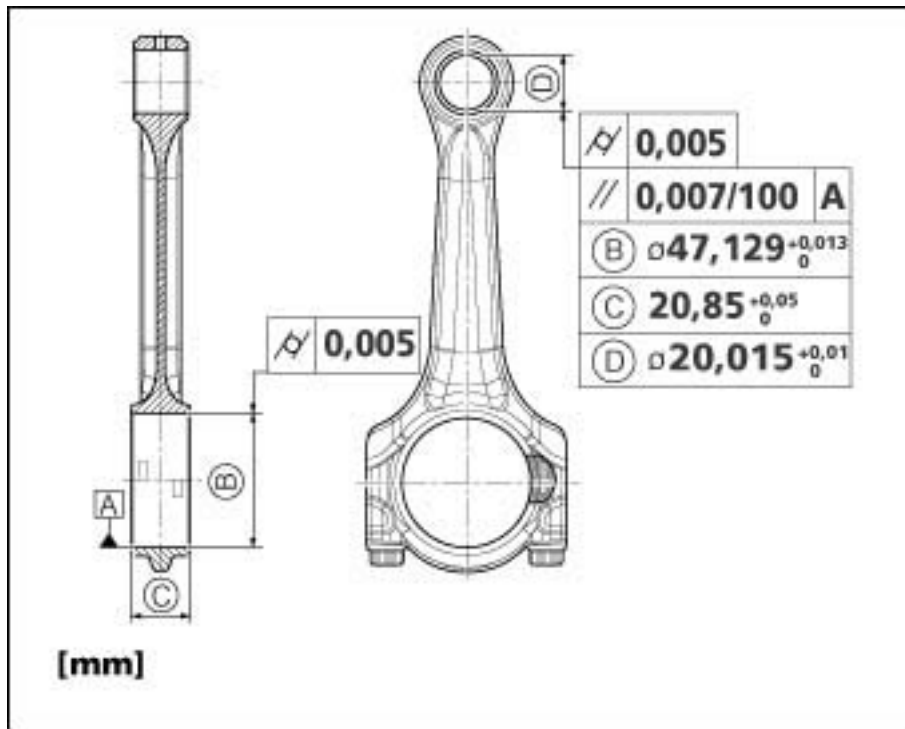

- To measure the diameter of the connecting rod small end, reset the bore meter on the indicated tool (diameter 20 mm).



- Check the diameter of the connecting rod small end taking two measurements at a distance of 90°.



- Proceed with a second inspection of the connecting rod small end using the "go-no-go" gauge **TLDF02060**



- The dimensions detected must fall within the indicated values.

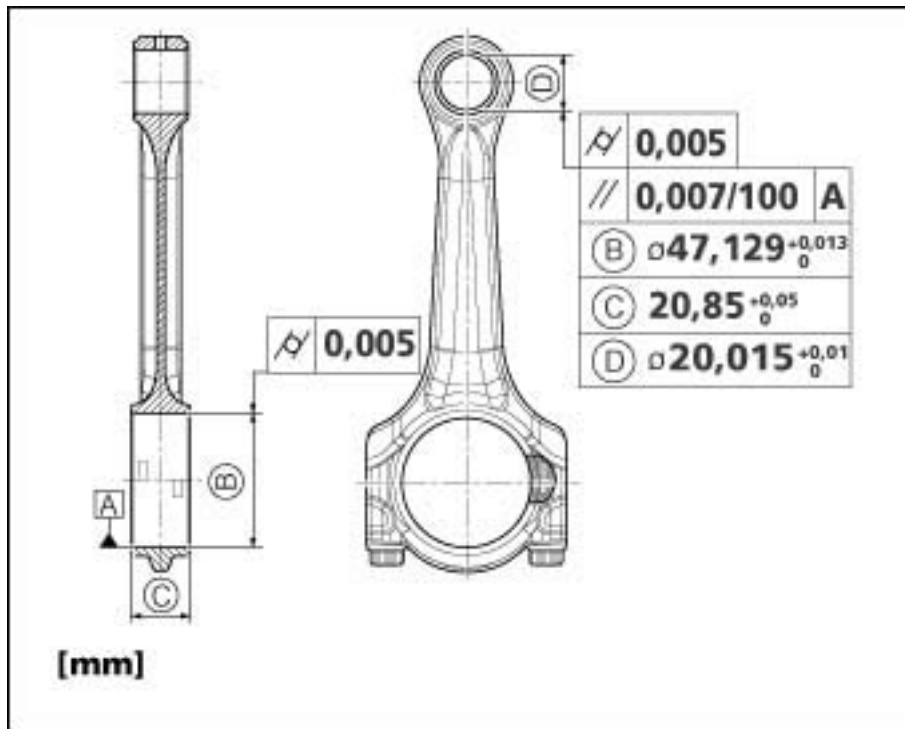

N.B.

To balance the connecting rod a checking plane is required.

- The parallelism of the connecting rod axes is checked by means of tool **AV2955**.
Insert the pins supplied into the connecting rod small end and the connecting rod big end, then check for any parallelism error with the dial gauge.



- Rotate the connecting rod by 90° and repeat the procedure.



- The values measured must correspond to those indicated in the drawing.

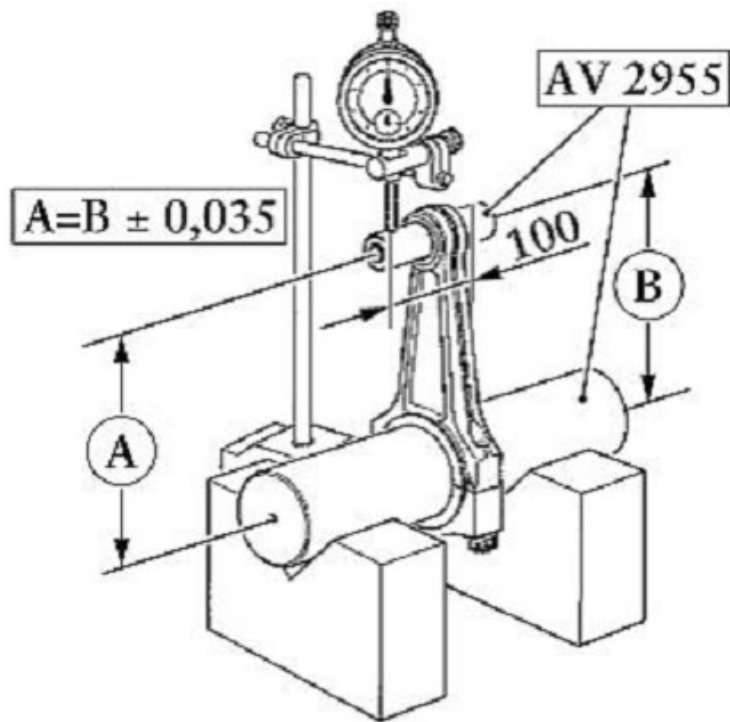

Cylinder liner dimensional check

N.B.

To carry out the dimensional check of the cylinder liners a bore-meter and the relative reference ring are required.

- Reset the bore-meter on the prescribed tool.



- Measure the diameter of the cylinder liner taking three measurements at the reference heights, then rotate the liner by 90° and repeat the procedure.



- The dimensions measured must fall within the indicated values.

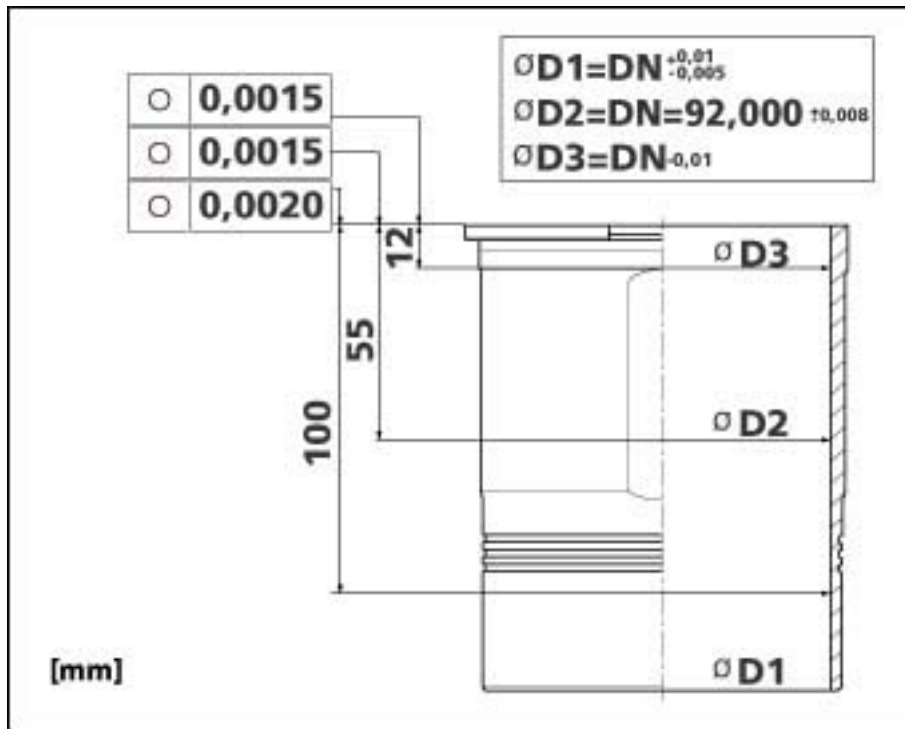

Drive shaft dimensional check

- Check that the main bearing journals do not show scoring or excessive wear.



- Check the condition of the rear plug on the clutch side.



- Using a tube-brush, check that the oil passages are not clogged.



- Measure the main bearing journals using a micrometer.



- The dimensions detected must fall within the indicated values.

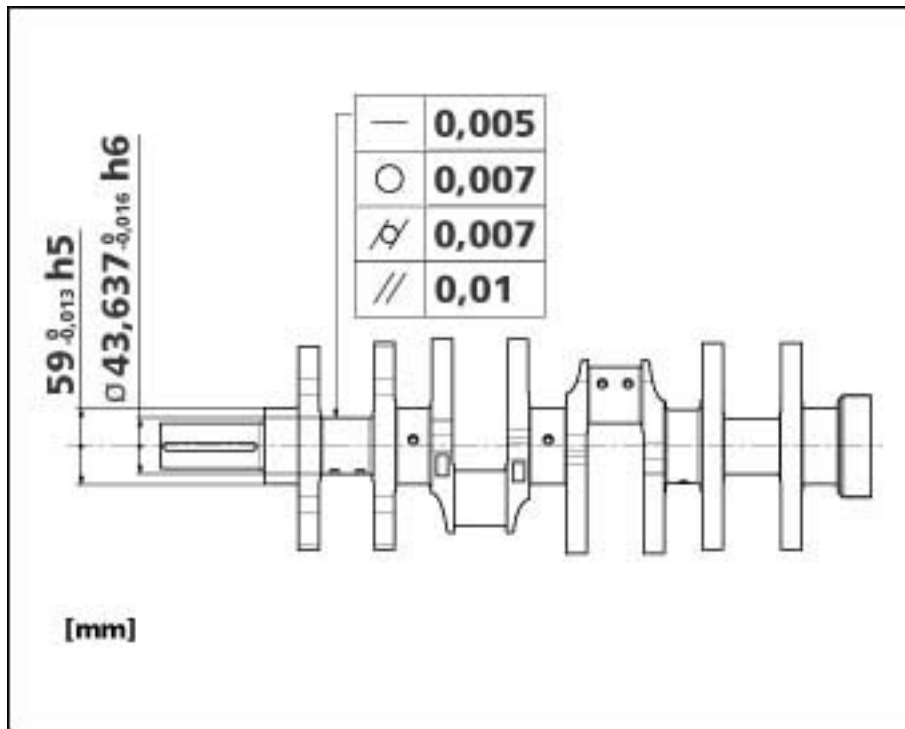

- Measure the crankpins with the micrometer.



- The dimensions detected must fall within the indicated values.

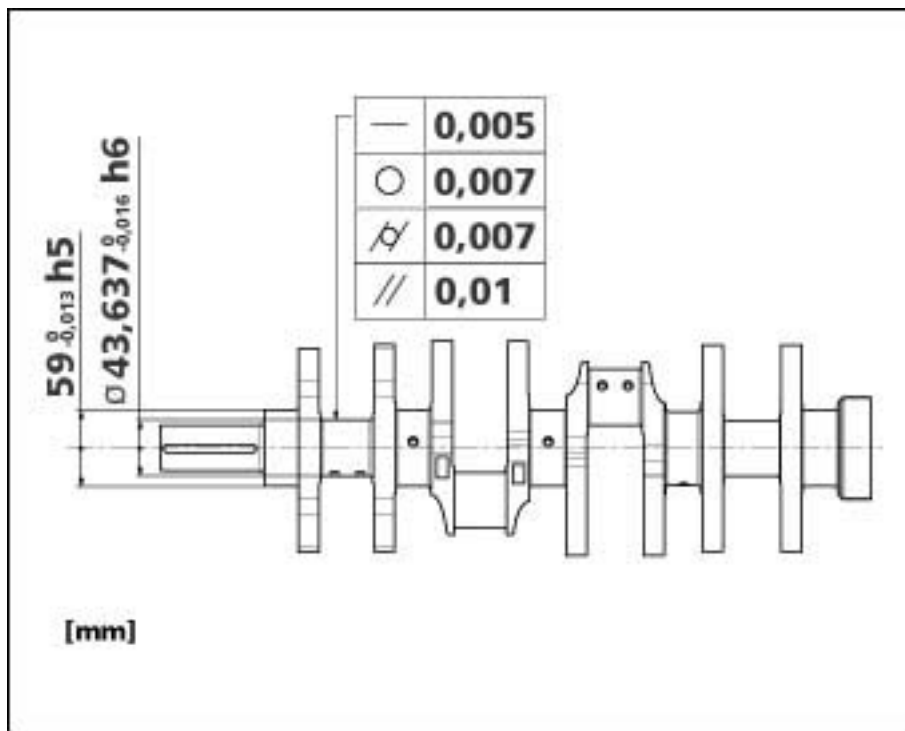

N.B.

To check the coaxial factor of the main bearing journals a checking plane is required.

- Arrange the crankshaft on the specified tool AV3135.



- Reset the dial gauge on the main bearing journal to be checked and rotate the shaft checking the dial gauge indication (**Figura 1 e 2**).

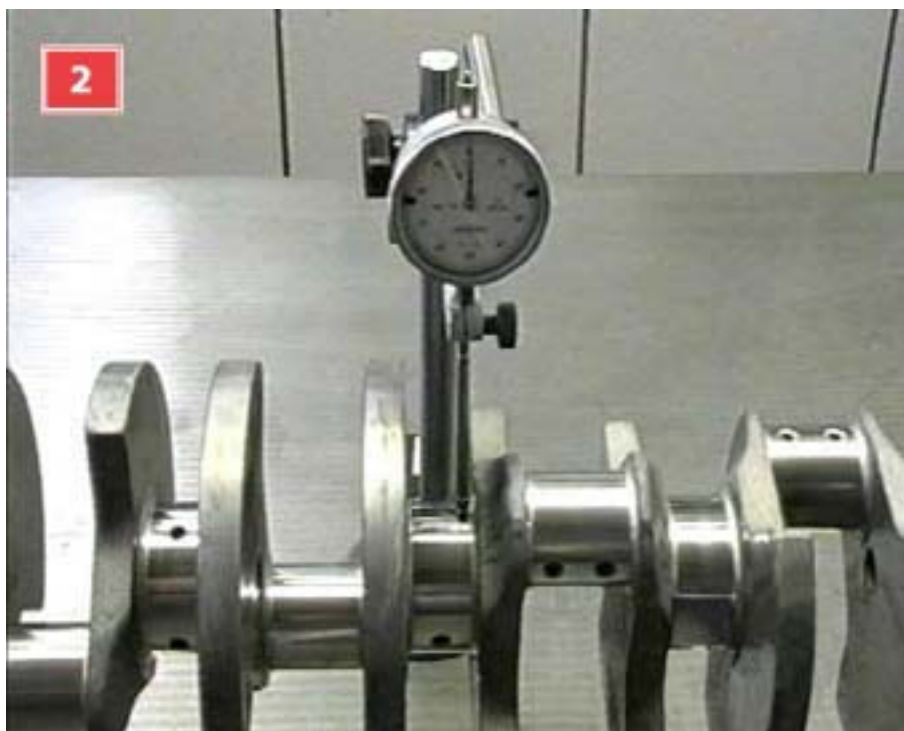

- The coaxial factor error detected must be lower than the indicated value.

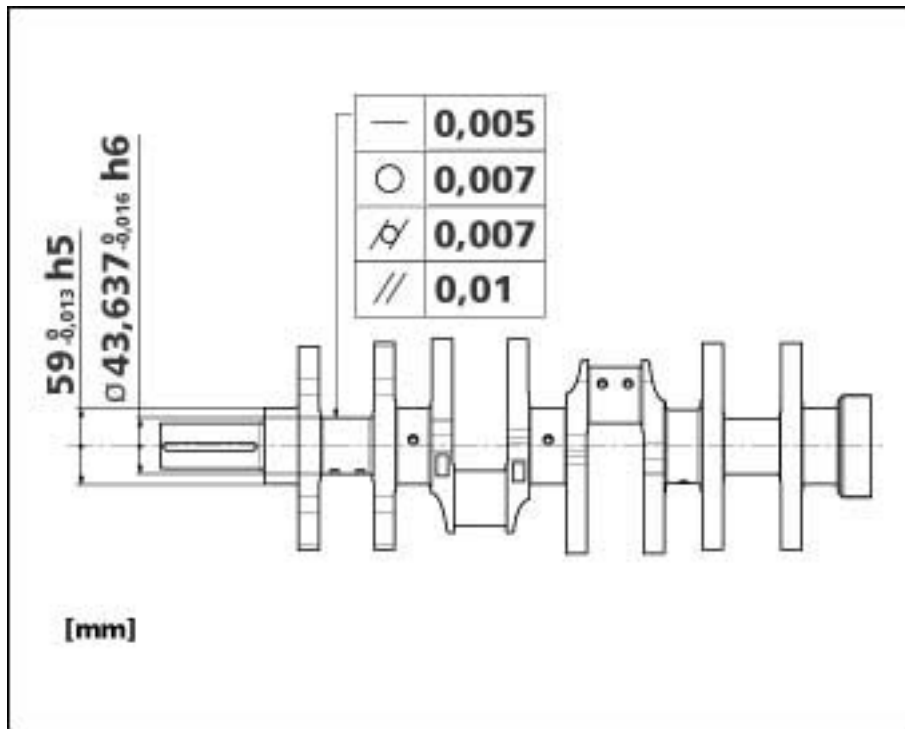

- Repeat the operation for the marked main bearing journals.

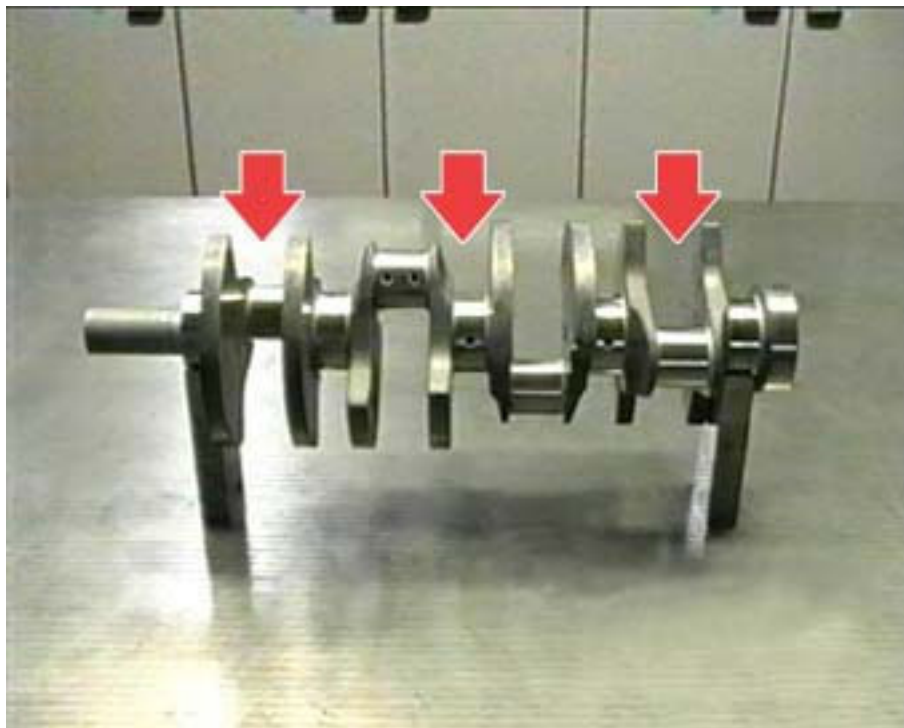

Main cylinder head data

Interference between the valve guide and the housing on the head	0.032 ÷ 0.068 mm
Interference between the valve seat and the housing on the head	
• Intake.	0,080 ÷ 0,140 mm
• Draining	0,080 ÷ 0,140 mm
Coupling between the valve rod and the relative guide	
• Fitting clearance (intake)	0,030 ÷ 0,060 mm
• Fitting clearance (draining)	0,035 ÷ 0,065 mm
• Wear limit	0.100 mm T.B.D.
Max. shift between valve stem and contact surface with bucket	
• Intake and draining	0.025 mm
Clearance between bucket and relative seat	
• Fitting clearance	0,025 ÷ 0,057 mm
• Wear limit	0,100 mm

Checking the cylinder heads

N.B.

To ensure the best working conditions, position the cylinder heads on the tool 900026520

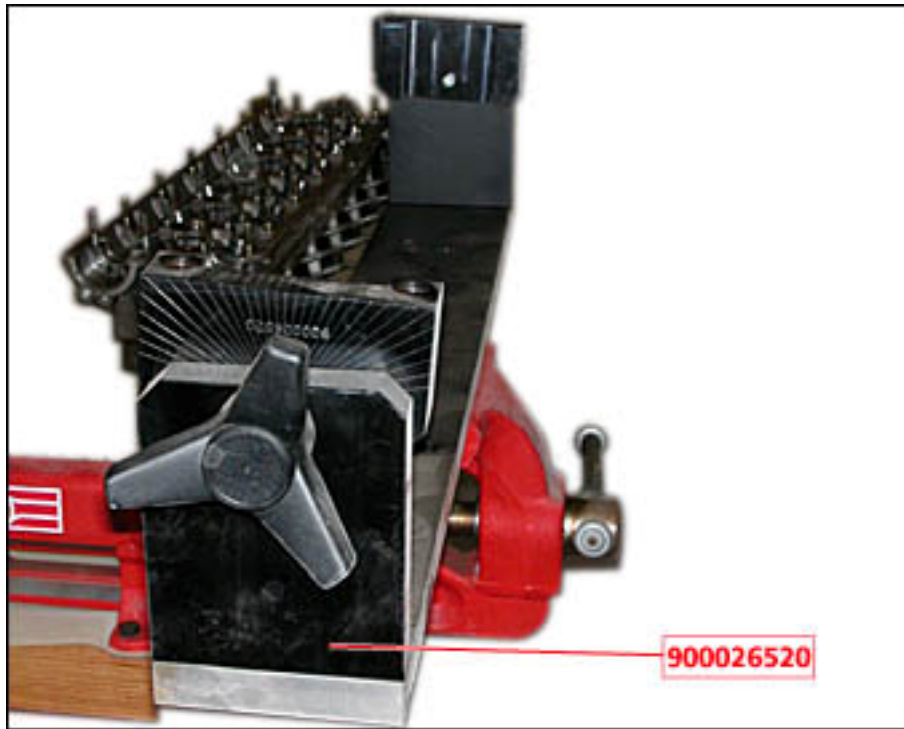

- Remove the valves, using specific standard pneumatic equipment.

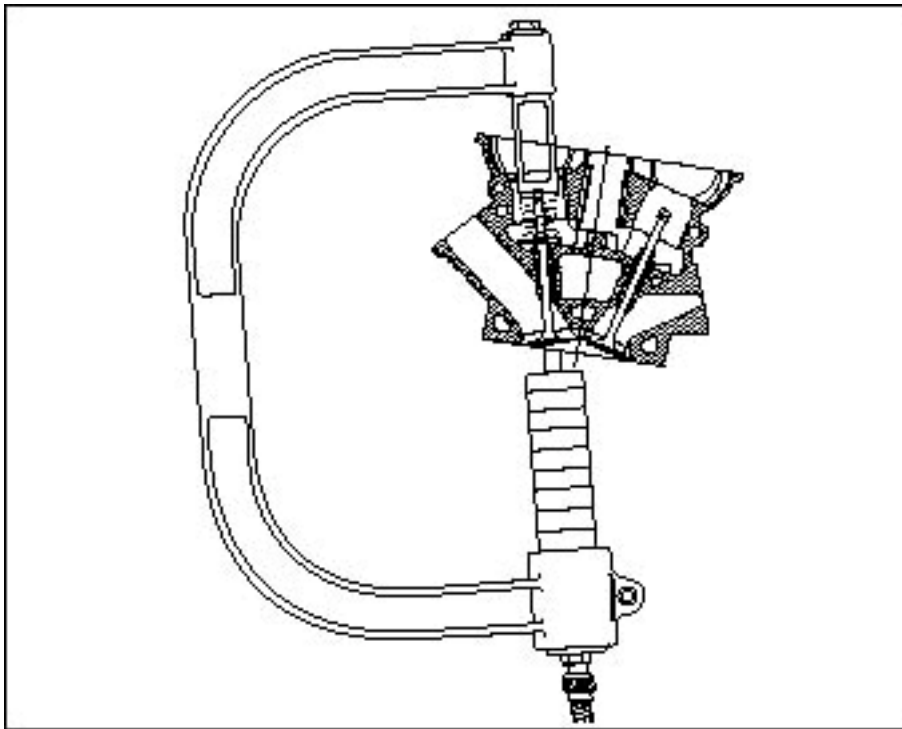

- Clean the heads carefully, removing all traces of scaling from the combustion chambers and the oil and water lines. For this purpose, it is advisable to inject pressurised petroleum into the oil lines and a standard descaling liquid into the water lines. Perform these operations with the aid of tool **900026970** (not shown).
- Check the state of the spark plugs' seats.
- Using the bore-meter, check the valve control bucket seats for wear and the camshafts seats.
- On a straightening surface, check if the head and crankcase coupling surfaces are perfectly flat.

- If the head surface needs to be corrected, always comply with the value given in the figure.

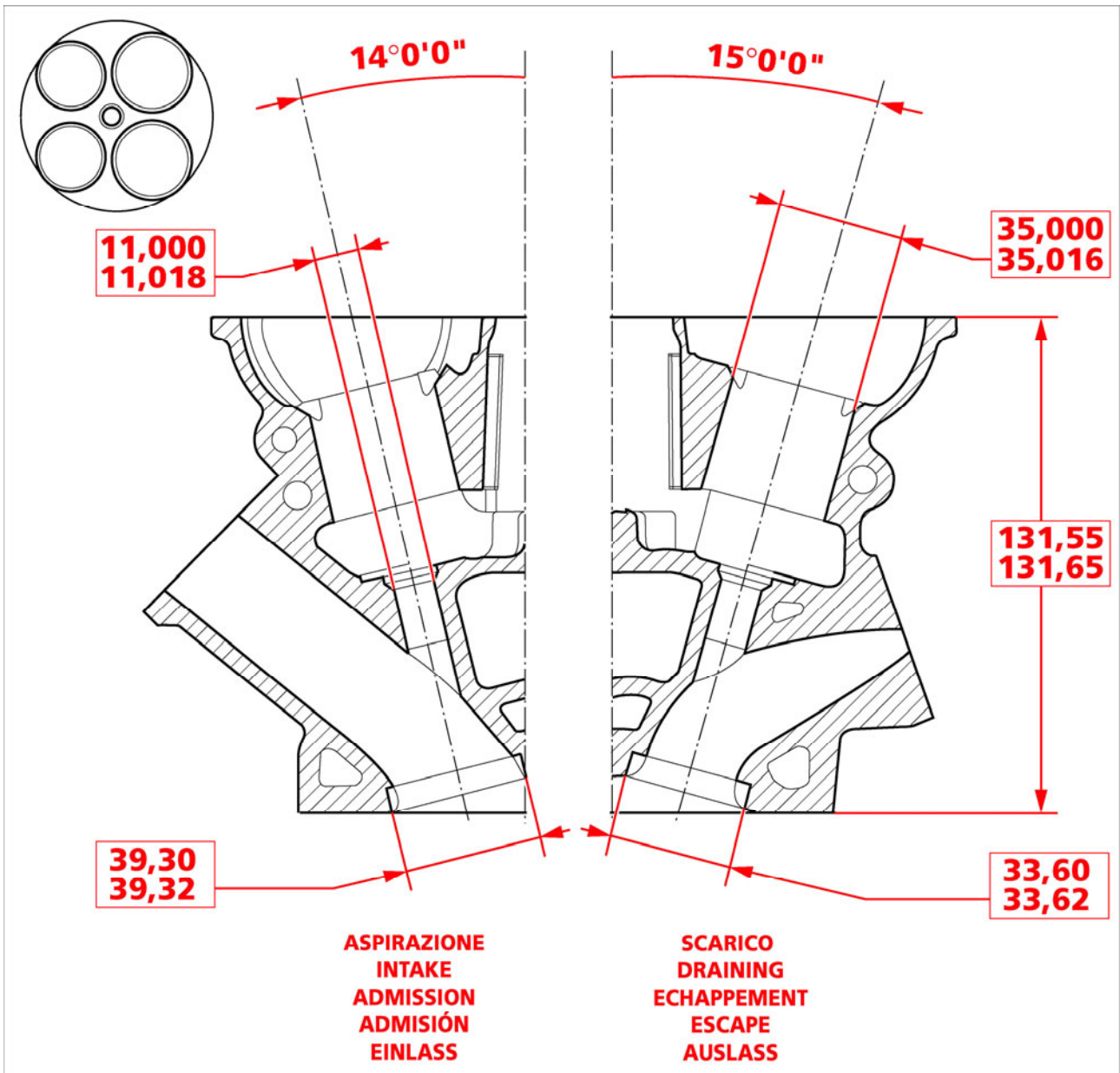

Checking the valve seats and guides

- Following the checks, if replacement of the valve seats is required, they must be removed by milling in order to prevent damage to the housing on the head.
- Check the dimensions of the grooves and the seats to ensure that the prescribed interference is created after assembly.
- To insert the new seats, heat the head in a kiln until it reaches a temperature of **190 °C**, for **six minutes**, then cool down the seats in liquid nitrogen, for about **five minutes**.

NOTES

The above described operation must be exclusively carried out by a specialized laboratory.

- Insert the seats onto the head using the special punch. Carefully check that the kickback does not cause the previously installed seats to fall out; if necessary, check that all installed seats are correctly fitted.
- Using gauge **TLDF 006108**, check the valve guides for wear.



- If the gauge inside the guide features an excessive backlash, replace with new guides in order to obtain the prescribed assembly engagement.
- The guides can be removed following the below procedure

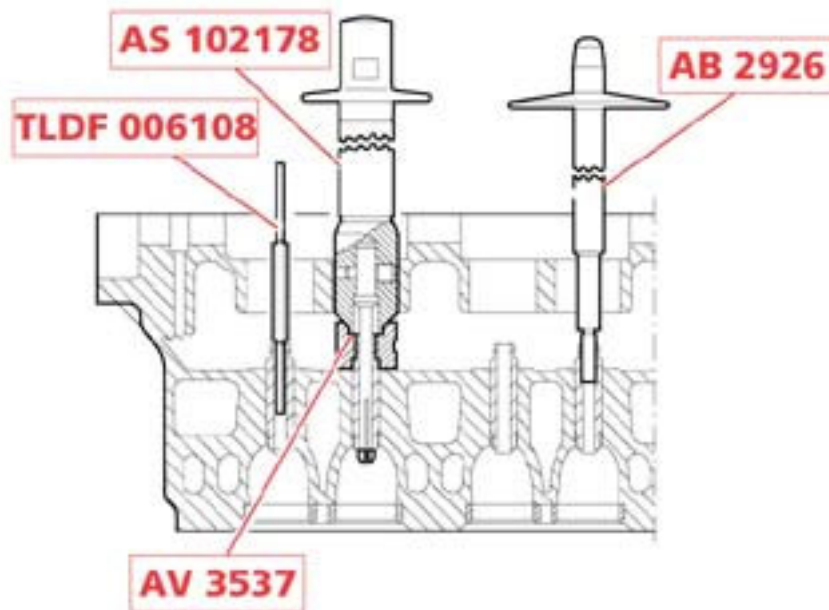

- Using tool **AV 2734** extract the seal rings **(1)** from the valve guides

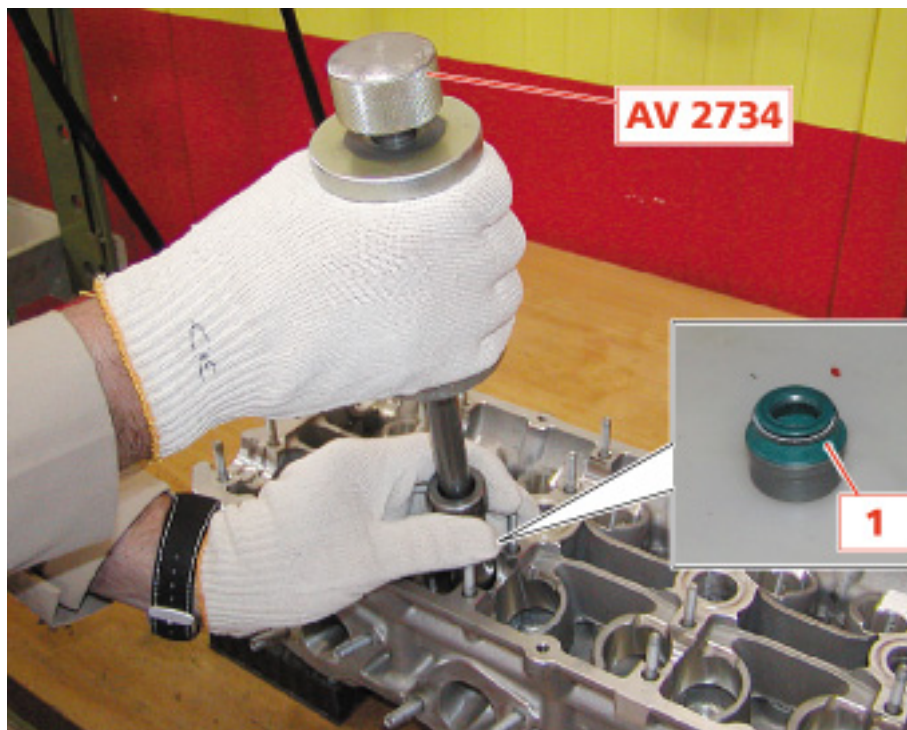

- Using a $\varnothing 10$ mm miller, with a $\varnothing 6$ mm tapered shank, supplied with tool **AV 2926**, mill the guide on the seal ring side for about **25 mm** from its end, lubricating the miller to prevent it from breaking and keeping it aligned with the valve guide.

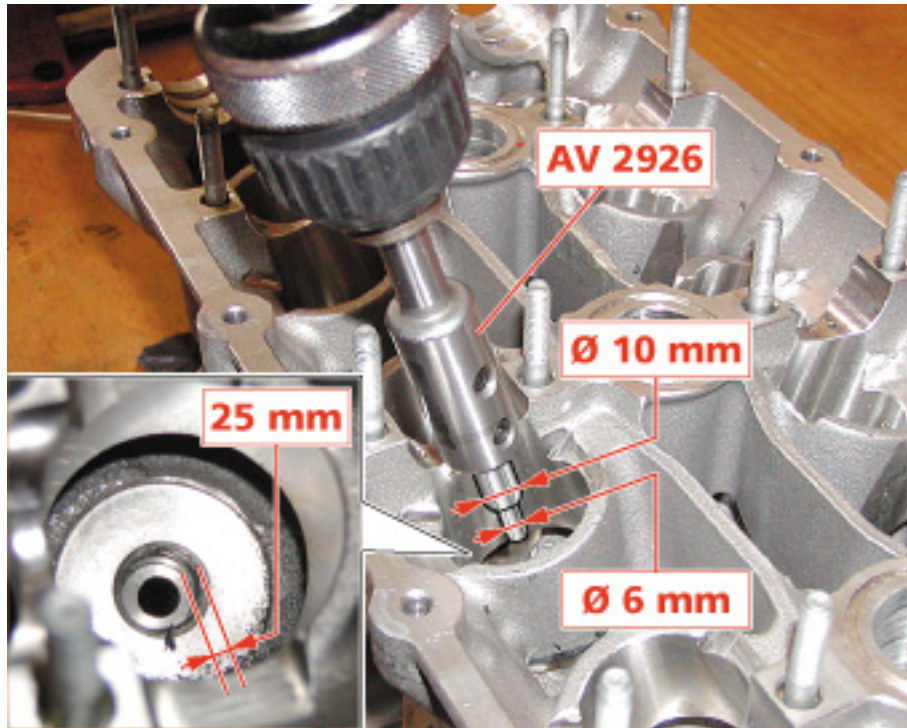

- Heat the head in a kiln at about **100 °C**, for ca. **thirty minutes**, to ease removal, then position it on two rubber shims.
- Extract the guide using the punch supplied with tool **AV 2926**.



- To insert the new guides, it is necessary to heat the head at about **100 °C** for ca. **1 hour** and then cool down the guides in liquid nitrogen.
- To install the new guide **(2)** use tool **AS 102178** with shim **AV 3537**.

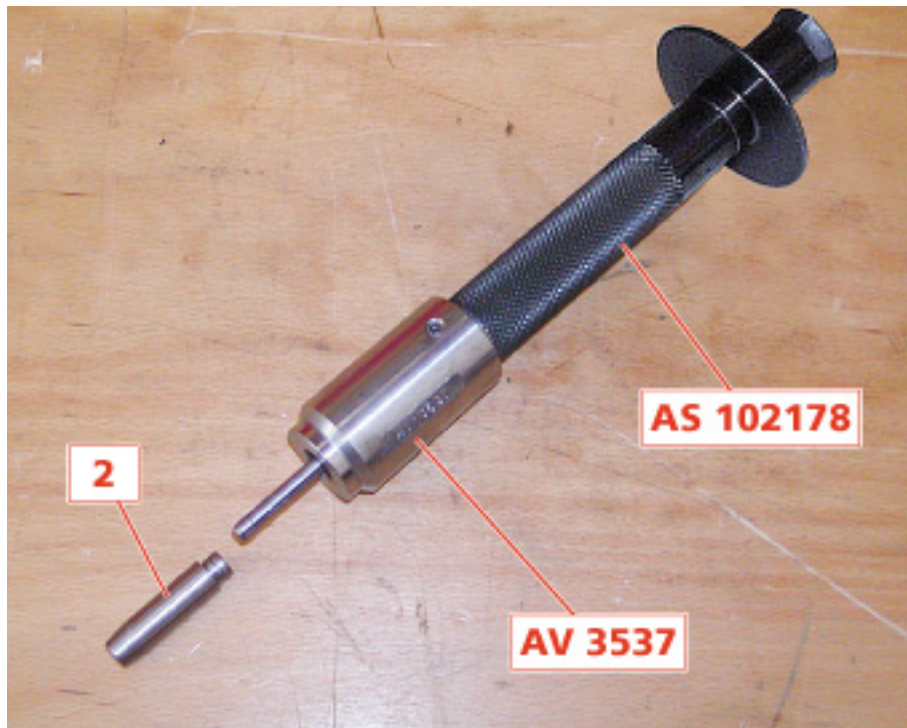

- Lubricate the guide with "SEGO" grease and push it into its seat, until the shim **AV 3537** comes flush with the head.

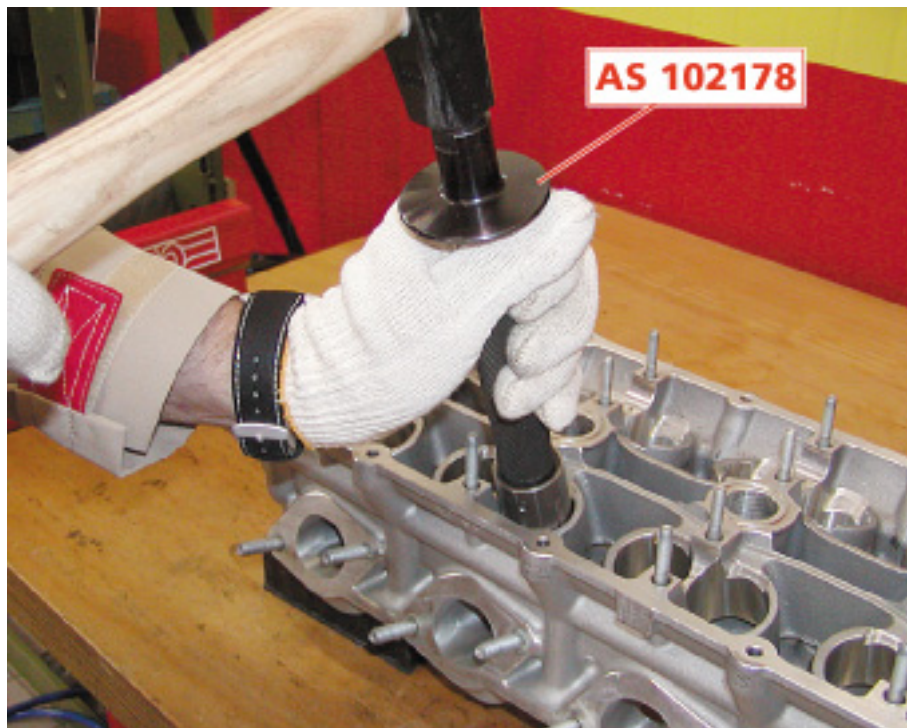

- After this procedure, **dry bore** the guides using a reamer (**3**) diameter **6 H7 mm**, fitted in the special hand-operated spindle. Before carrying out the operation, check that the reamer cutting edges are sharp.

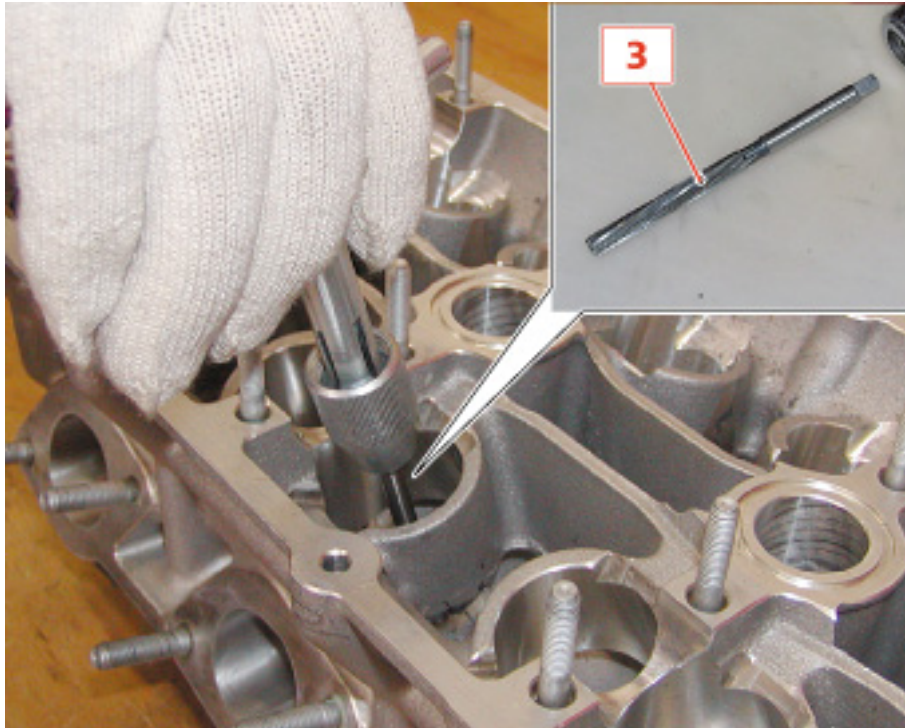

- Using gauge **TLDF 006108**, directed towards side "P", check that the guide is properly bored.



If, once the checks have been carried out, the valve seats need to be replaced, remove them by milling in order to prevent damaging their seat on the head.

- Check the dimensions of the recesses and seats.
- After fitting, it is absolutely essential to have the indicated interference.
- To fit the new seats, heat the head in the oven to a temperature of **190°C** for six minutes, and cool down the seats in liquid nitrogen for approx. **five minutes**.

N.B.

The above described operation must be carried out by a specialized laboratory only

After having replaced the valve guides, it is necessary to grind the valve seats, thereby obtaining the prescribed union angle in order to perfectly match the seat-valve support surfaces. For this operation, use the recommended grinder for valve seats equipped with the relative

- To work on both sides of the head, position it on the special supports, working from the lid side.
- Insert the centering stem into the guide **(4)**, diameter **6 mm**, working from the side equipped with tightening screw.

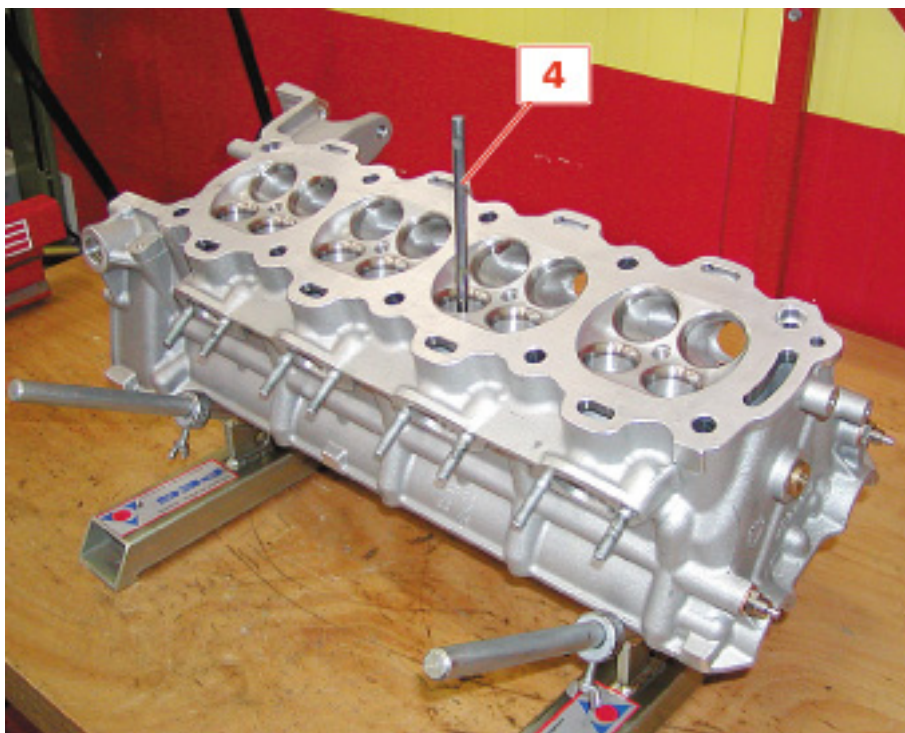

- Lock the centering stem in the guide (4), by means of the tightening screw (5).

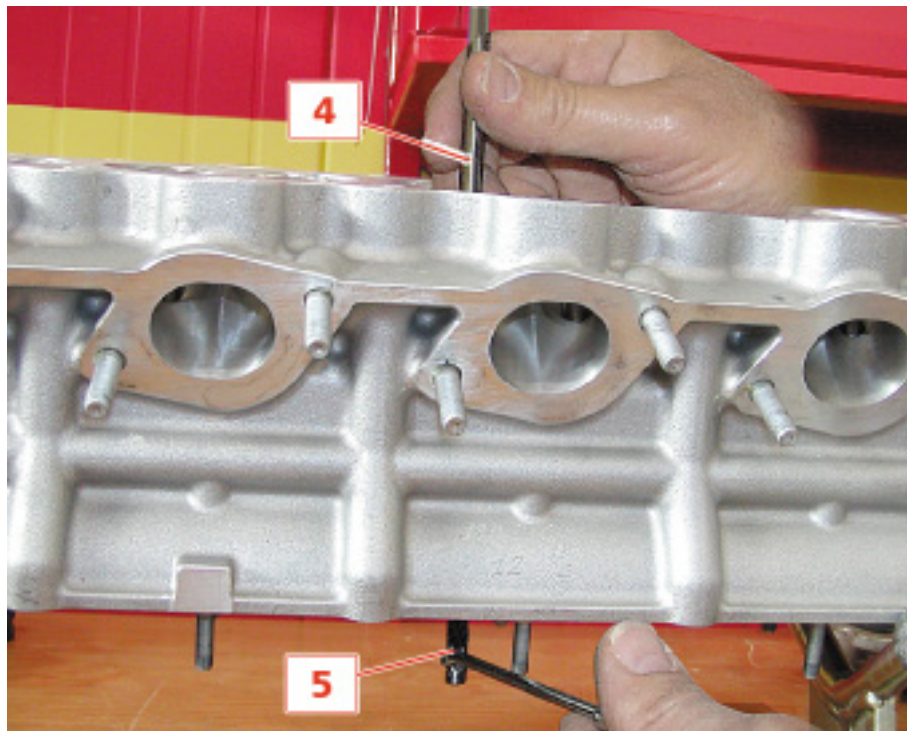

- The grinder must be fitted with the specific wheel for the valve seat to be machined:
 - for the intake valves use a **37 mm** diameter wheel;
 - for the exhaust valves use a **33 mm** diameter wheel.

NOTES

The wheel outer diameter must be slightly larger than that of the valve.

- Set the diamond point inclination (**6**) to **45°**, with respect to the fixed index on the base.
- Sharpen the wheel swinging the small connecting rod (**A**) which holds the diamond point and, at the same time, operate the control knob (**B**).

IMPORTANT

To prevent the abrasive product from infiltrating into the camshaft central hole, plug the latter and clean with compressed air

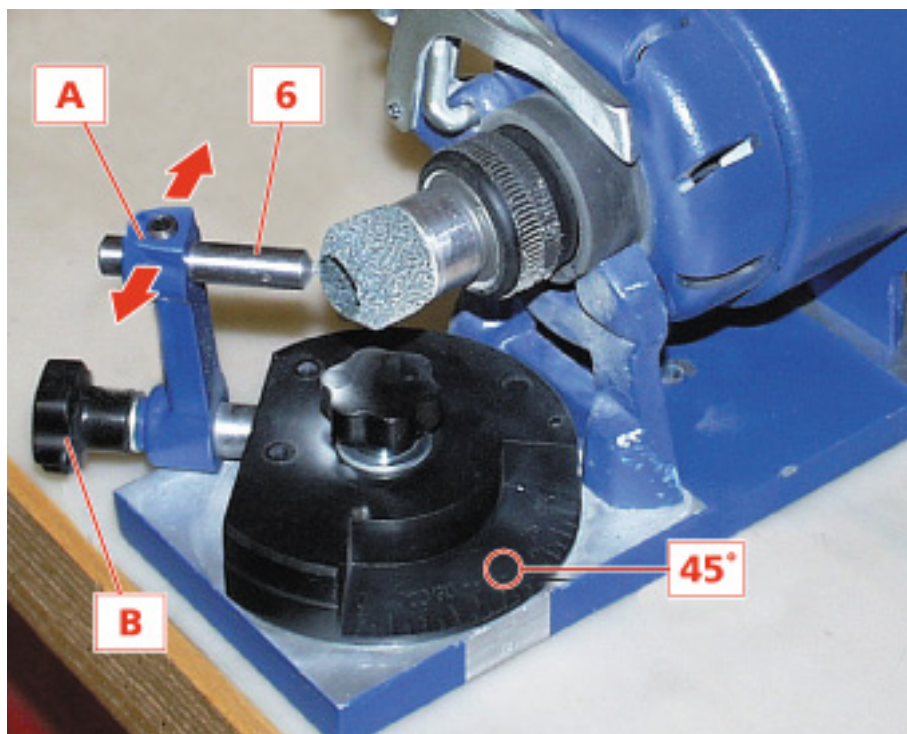

- Grease the centering stem and fit the grinder
- Move the wheel so that it skims the valve seat, and lock the screw which positions the knob **(7)** used to adjust the cutting depth..



- Start-up the grinder and machine the valve seat, gradually increasing the cutting depth using the knob **(7)**.
- Grind the whole surface **(H)** of the valve seat, letting the machine work freely for a few seconds. Check the working depth and the alignment (centering) of the machining with respect to the seat, adjusting the grinder position if necessary..

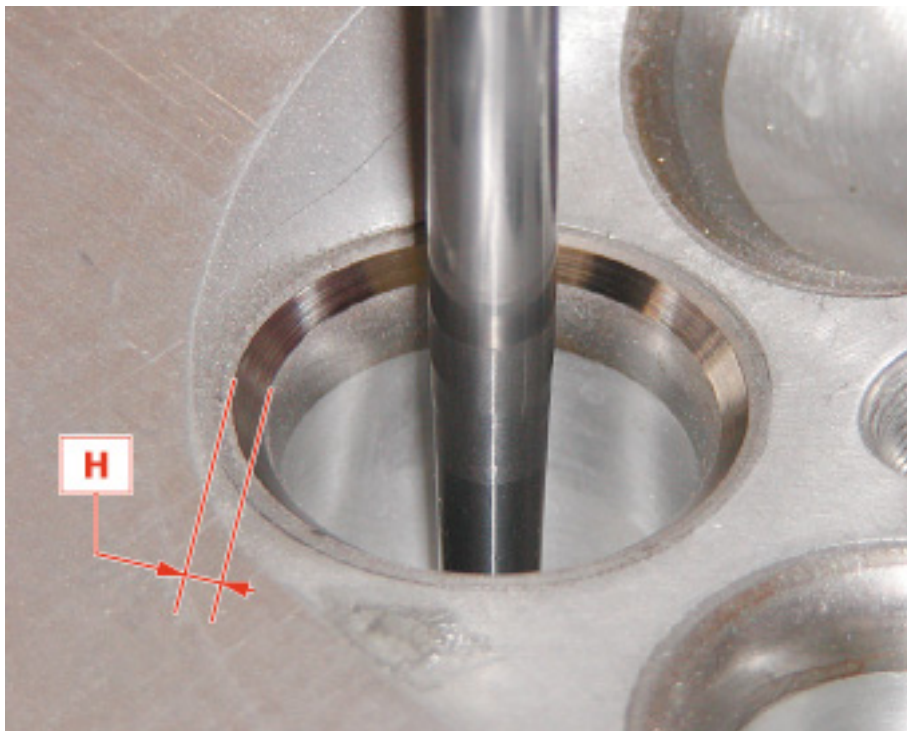

- Once the machining procedure is completed, lift the wheel operating the knob then remove it from the centering stem.
- Release the centering stem, working on the lower tightening screw.
- Using tool **(C)** supplied with the grinder, extract the centering stem **(4)** from the valve guide.



IMPORTANT

After having ground the seats as described above, it is not necessary to lap the valves before re-assembly.

There are two methods for checking the seat machining:

- application of a "Prussian Blue" layer;
- check of the hydraulic seal with "Vacutest".

Check through the application of a "Prussian Blue" layer

- Using a paintbrush, apply a thin and uniform layer of "Prussian Blue" on the whole resting surface of the valve.
- Insert the valve into its guide, making it "strike" on its seat.
- Then rotate it manually and, after having removed it, check that the "Prussian Blue" layer is evenly distributed on the whole seat. If this is not the case, grind the seat once again.



Check of the hydraulic seal with "Vacutest"

- Fit all the valves for a duct (intake or exhaust) and, in order to avoid that the cotter grooves - on the valve stem - damage the inside sealing surface of the grommet, fit the protection cap **AV 2944** and lubricate the coupling with engine oil



- Fit the sealing rings on the valve guides to be tested using the fitting tool **900026980** (Maserati part no.) or **AV 2692** (Ferrari part no.).

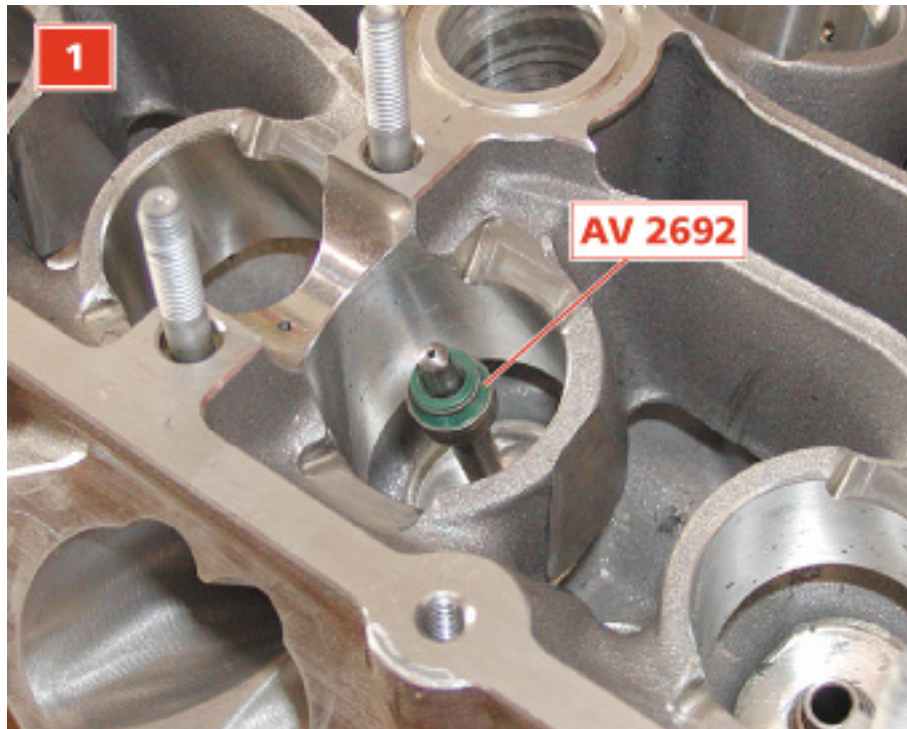

- Fit the rectangular punch (**D**), supplied with the equipment, to plug the intake duct. Fit a round-shaped punch to plug the exhaust duct
- Activate the "Vacutest" and check on the pressure gauge that vacuum ranges between **0,94** and **0,86 bar**. If the value proves to be lower, check once again applying a "Prussian Blue" layer, in order to verify which is the seat to be ground once again.

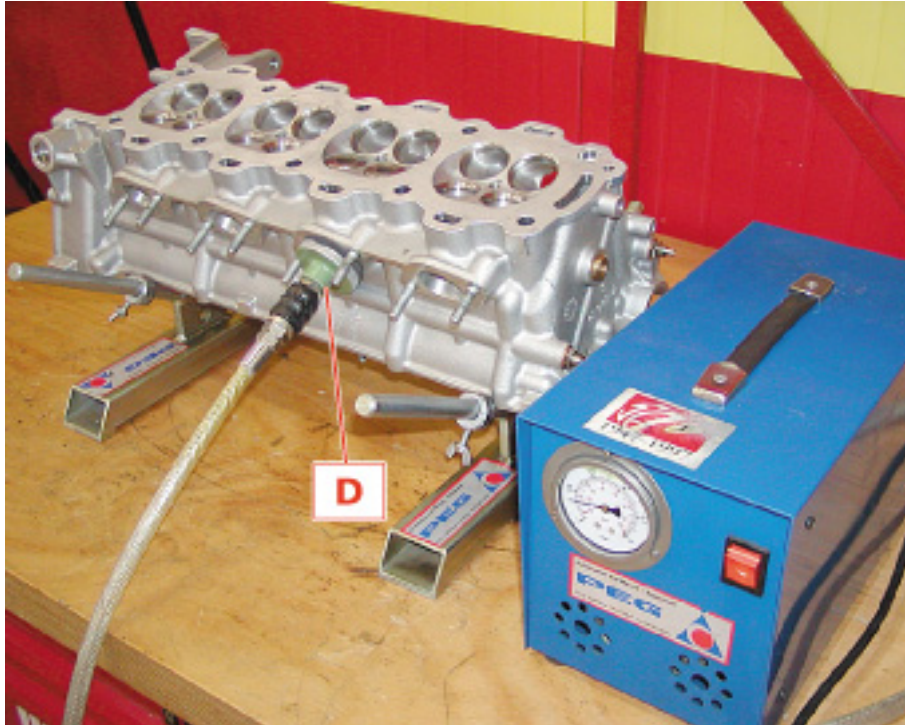

Fitting the valves and checking the springs

- During servicing, after a careful examination, check the state of the valves (Figure 1 and 2) and, if necessary, replace them.

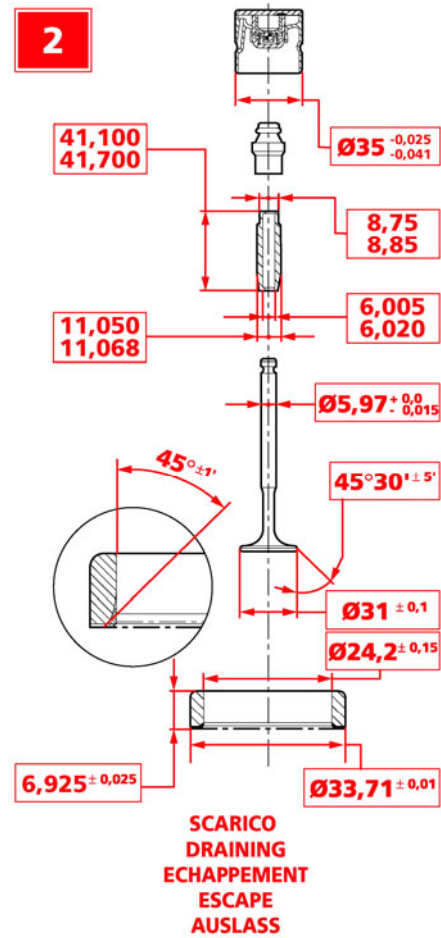
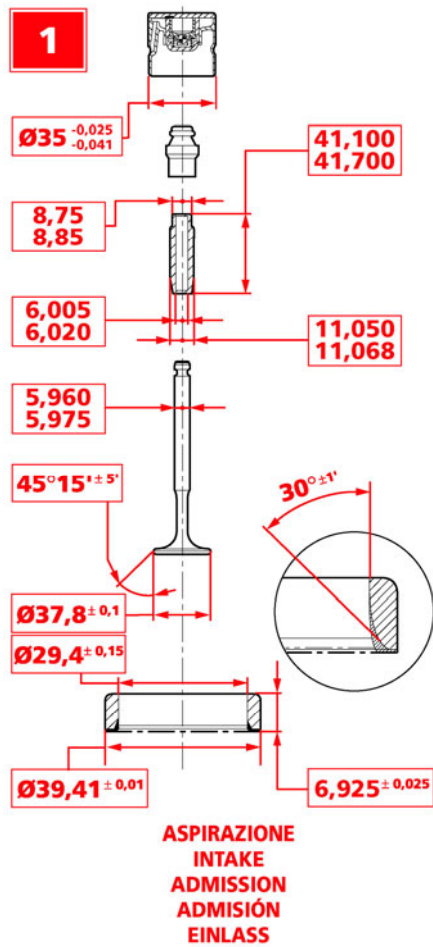

- Whenever necessary or, in any case, when fitting new valves, replace the grommets, using the punch **AV 2692** to insert them.
- To prevent the cotter grooving on the valve stem damaging the inner surface of the grommet, fit the protective cap **AV 2944** and lubricate the coupling with engine oil.

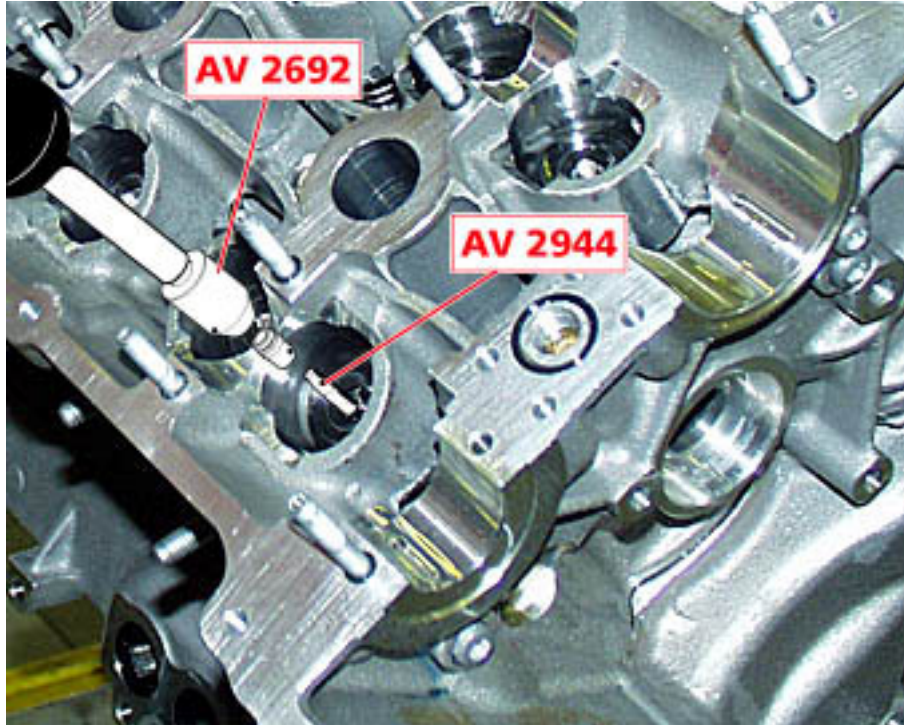

- The figures 3 and 4 show the nominal lengths (L) the spring must have depending on the charge (N) applied.

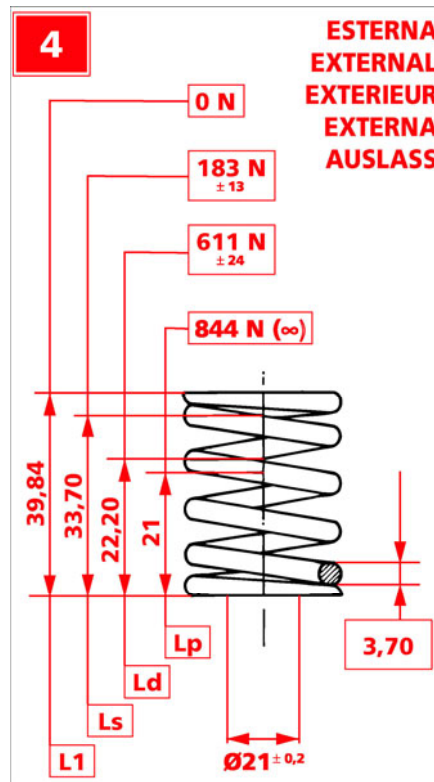
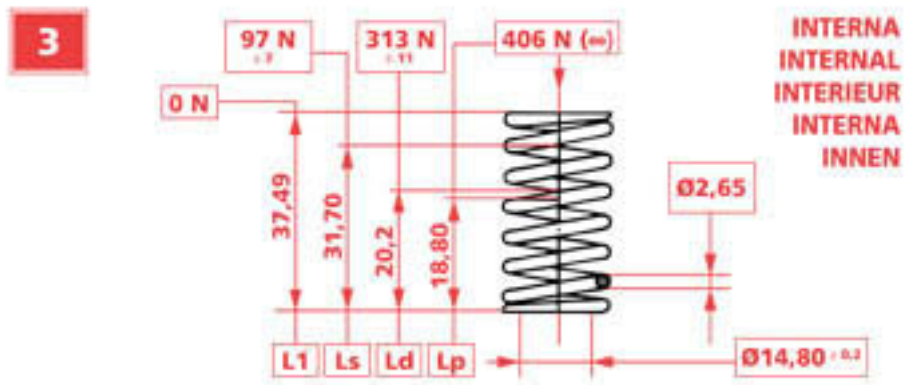

- Replace the deformed springs with new ones with a static charge of 30 ÷ 50 N
- Examine the upper and lower washers visually to make sure they are intact.
- Refit the components, using the compression tool employed to remove them.

- The outer and inner valve springs must be fitted in a specific direction. A mark indicates the correct fitting direction: the marked end of both springs must be positioned in contact with the engine head.



- Fit the hydraulic tappets, abundantly lubricating the housings on the head and checking them for wear. The tappets on the head do not need to be positioned following a specific sequence, however, it is recommended to refit the hydraulic tappets following the same order in which they were removed.

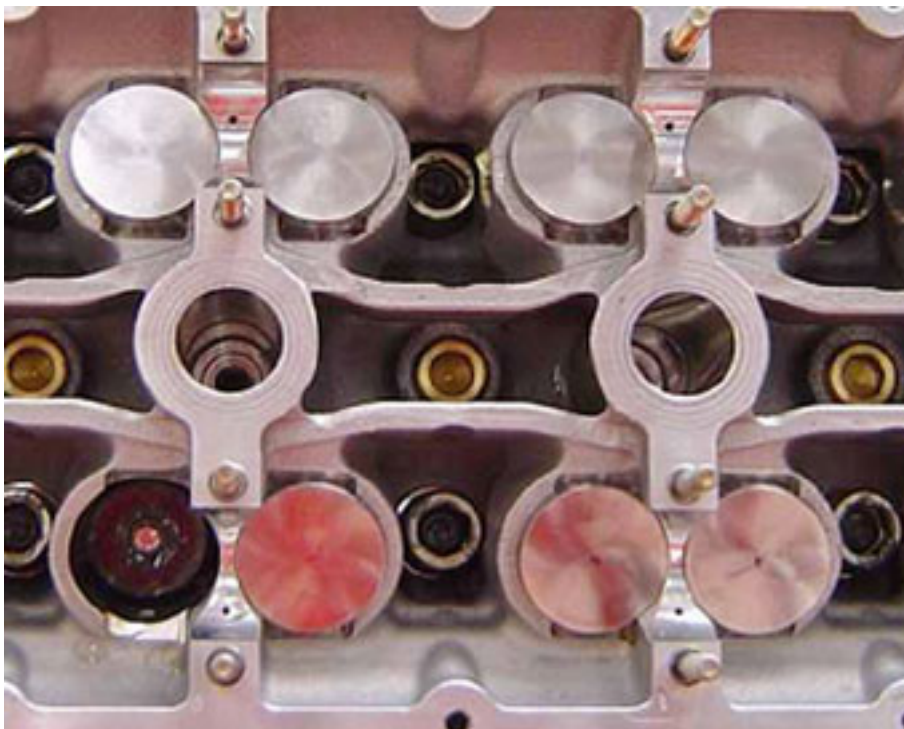

SECONDARY AIR PUMP

Removing-refitting the secondary air pump

- Place the vehicle on the hoist.
- Remove the floor guard beneath the engine
Removing-refitting the engine floor guard
- Remove the trim guards.



- Detach the electrical connection on the air flow meter and release the two clips from the air filter housing.



- Remove the air flow meter fastening clamp.



- Remove the air flow meter.



- Remove the two cold air intake lines.



- Release the clips fastening the cover to the air filter housing.



- Remove the cover and take out the air filter.



- Undo the screw fastening the air filter housing to the domes' bar.



- Remove the air filter housing.



- Disconnect the hosing from the pump.



- Lift the hoist and undo the lower fastening screw on the air pump support bracket.



- View of the part removed, showing the correct position of the lower fastening screw, accessible with the vehicle lifted and working from underneath the vehicle itself.



- Lower the hoist and undo the upper fastening screw on the air pump support bracket.

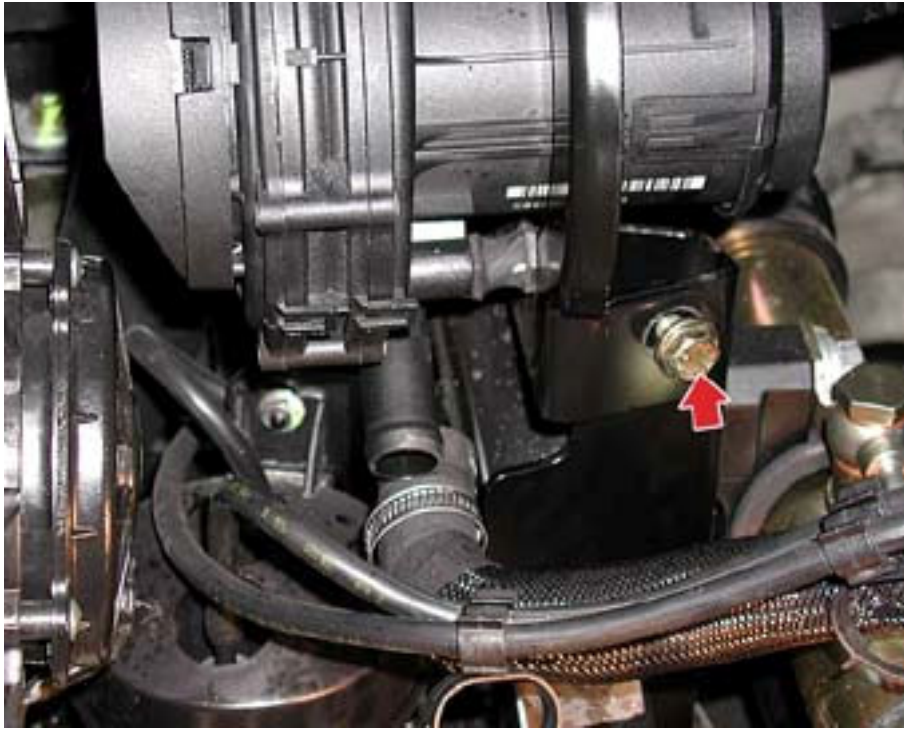

- Detach the electrical power supply connection and remove the supplementary air pump.



- With the component on the bench, undo the screws fastening the pump to the bracket and detach them.



When refitting, follow the above procedures in reverse order and, in addition, clean the air flow meter and the filter housing thoroughly to prevent the infiltration of impurities which could impair the operation of the air flow meter sensor.

VACUUM TANK

Removing-refitting the vacuum tank

- Place the vehicle on the hoist.
- Remove the floor guard beneath the engine
Removing-refitting the engine floor guard
- Remove the trim guards.



- Detach the electrical connection on the air flow meter and release the two clips from the air filter housing.



- Remove the air flow meter fastening clamp.



- Remove the air flow meter.



- Remove the two cold air intake lines.



- Release the clips fastening the cover to the air filter housing.



- Remove the cover and take out the air filter.



- Undo the screw fastening the air filter housing to the domes' bar.



- Remove the air filter housing.



- Lift the hoist and unscrew the nut fastening the two oil pipes' bracket.

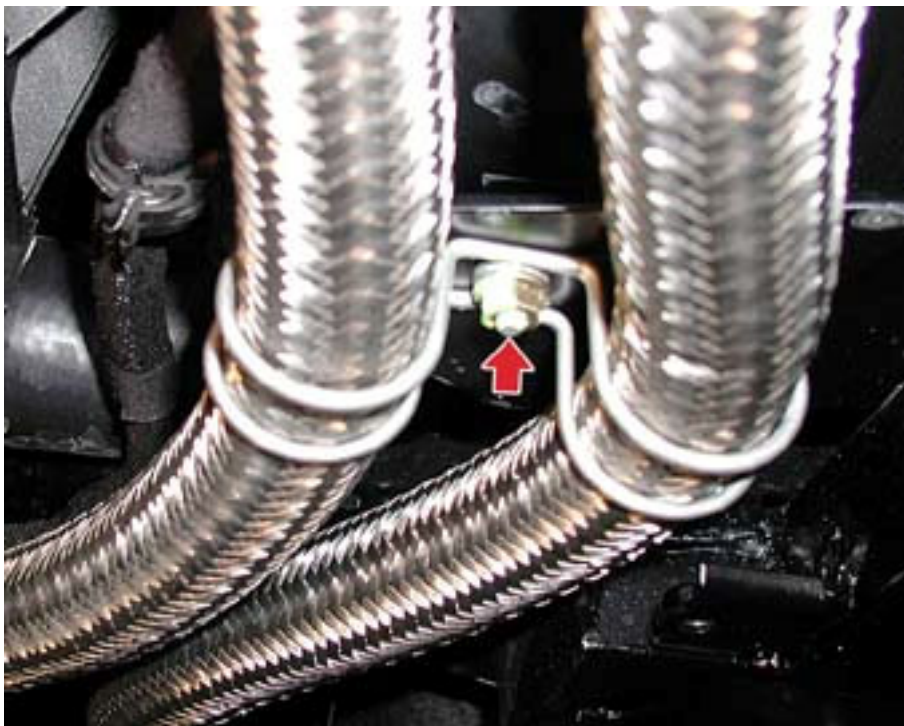

- Loosen the lower fastening nut on the vacuum tank.

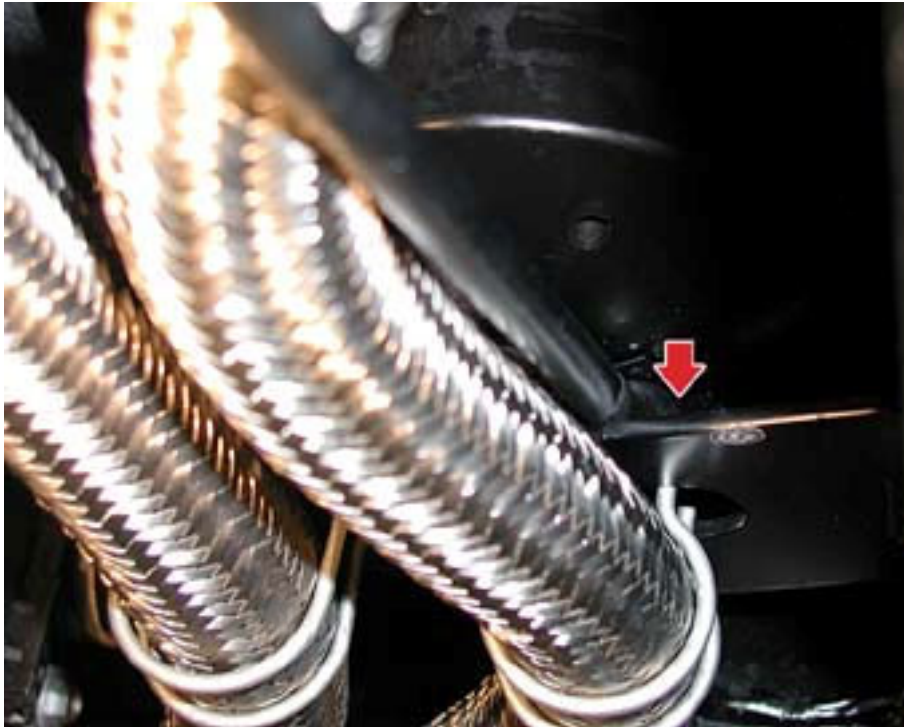

- Lower the hoist and loosen the upper fastening nut on the vacuum tank.

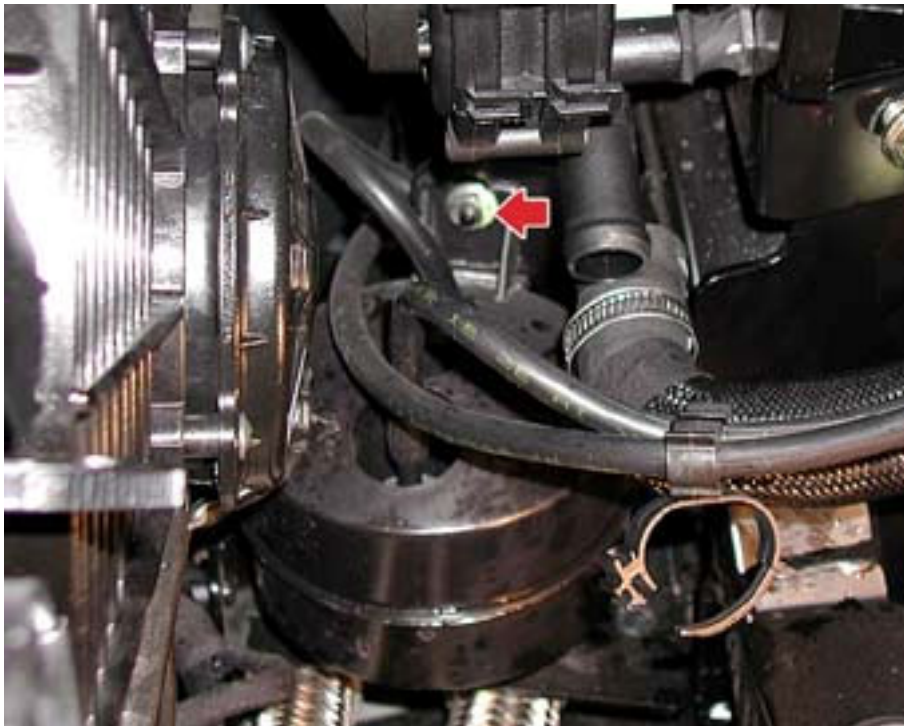

- Disconnect the two vacuum lines and remove the vacuum tank.



When refitting, follow the above procedures in reverse order and, in addition, clean the air flow meter and the filter housing thoroughly to prevent the infiltration of impurities which could impair the operation of the air flow meter sensor.

PNEUMATIC ACTUATOR CONTROL SOLENOID VALVE

Removing-refitting the pneumatic actuator control solenoid valve

- Place the vehicle on the hoist.
- Remove the secondary air pump.

Secondary air pump

- Undo the two fastening screws, detach the electrical connection, disconnect the two vacuum lines and remove the pneumatic actuator control solenoid valve.



When refitting, follow the above procedures in reverse order.

UNION BETWEEN PUMP AND PIPELINE FOR AIR DISTRIBUTION TO VALVES

Removing-refitting the union between the pump and the pipeline for air distribution to the valves

- Remove the trim guards.



- Detach the electrical connection on the air flow meter and release the two clips from the air filter housing.



- Remove the air flow meter fastening clamp.



- Remove the air flow meter.



- Remove the two cold air intake lines.



- Release the clips fastening the cover to the air filter housing.



- Remove the cover and take out the air filter.



- Undo the screw fastening the air filter housing to the domes' bar.



- Remove the air filter housing.



- Disconnect the union from the air pump.



- Disconnect the sleeve from the pipeline, open the clamps and remove it.

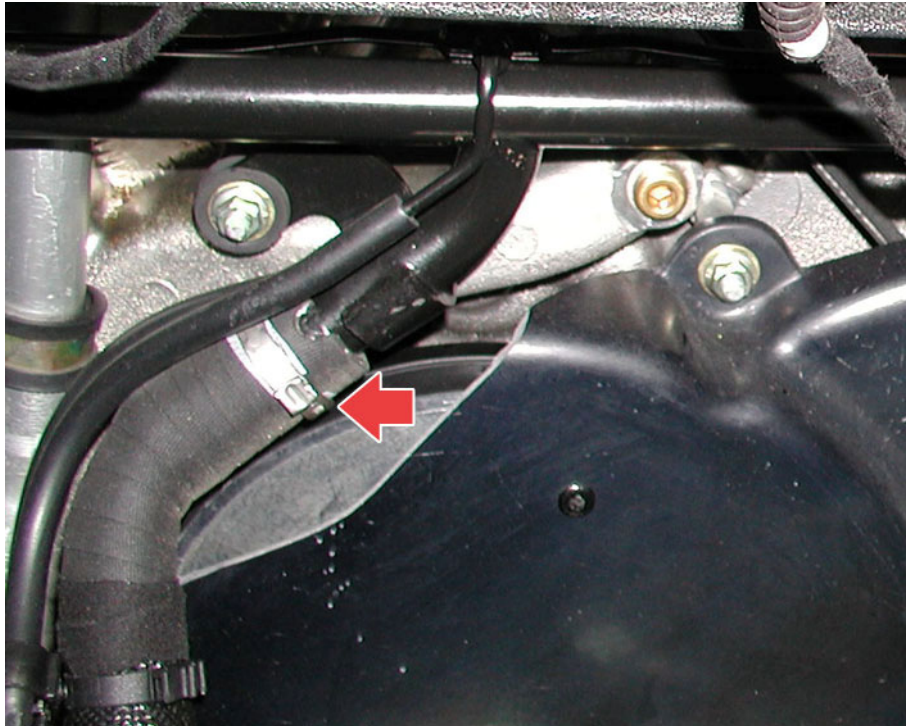

When refitting, follow the above procedures in reverse order and, in addition, clean the air flow meter and the filter housing thoroughly to prevent the infiltration of impurities which could impair the operation of the air flow meter sensor.

SECONDARY AIR PNEUMATIC ACTUATOR VALVES

Removing-refitting the secondary air pneumatic actuator valves

- Remove the floor guard beneath the engine
Removing-refitting the engine floor guard
- Remove the trim guards.

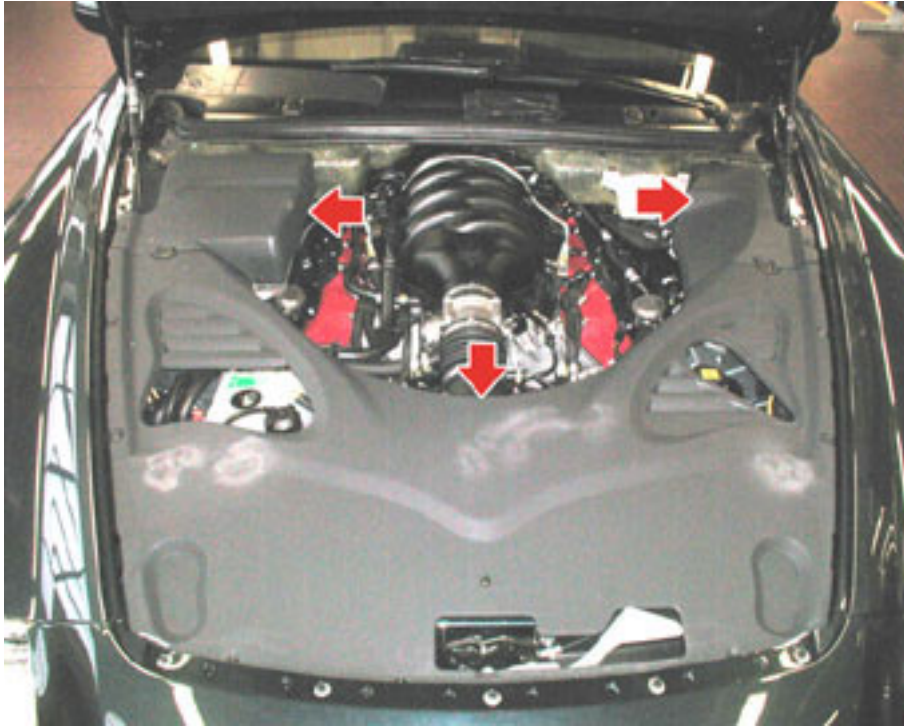

- Disconnect the air hose from the pipeline.



- Disconnect the vacuum air pipe from the valve.

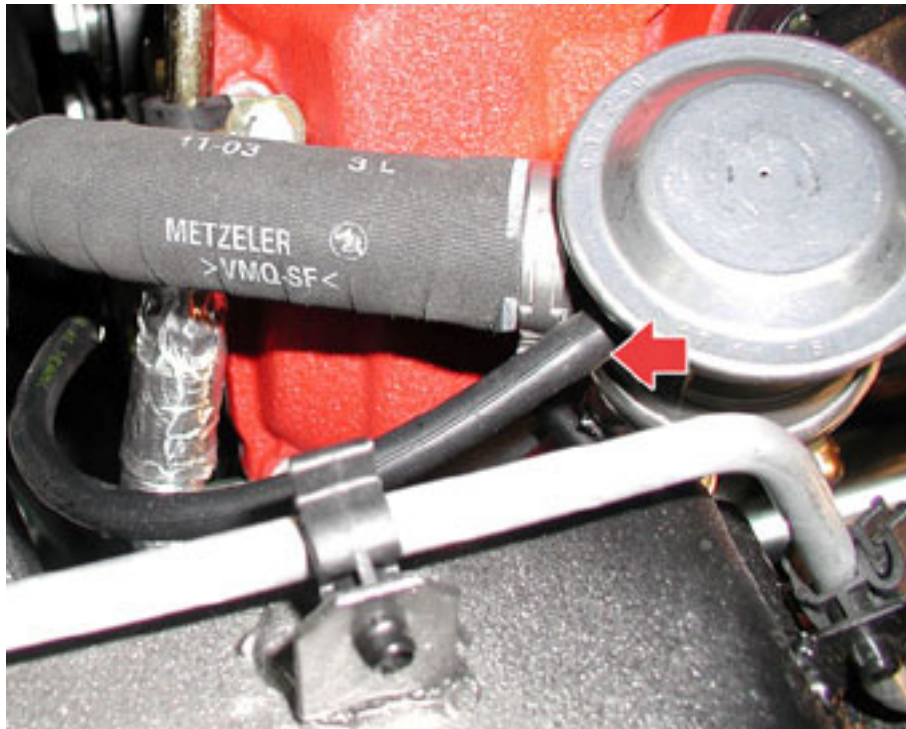

- Undo the front fastening screw on the valve support bracket.

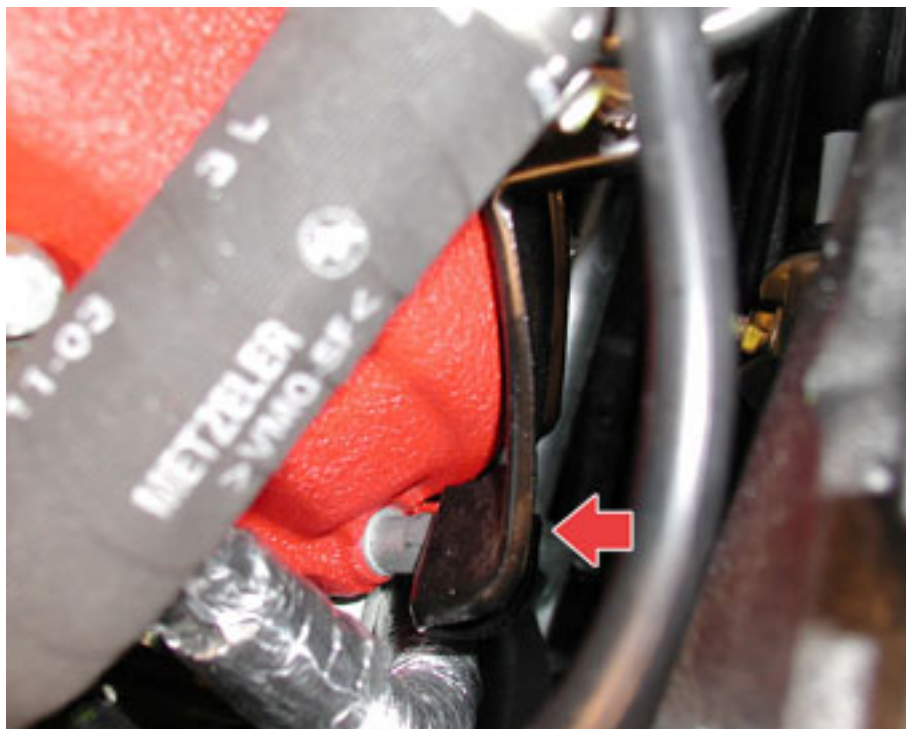

- Undo the rear fastening screw on the valve support bracket.

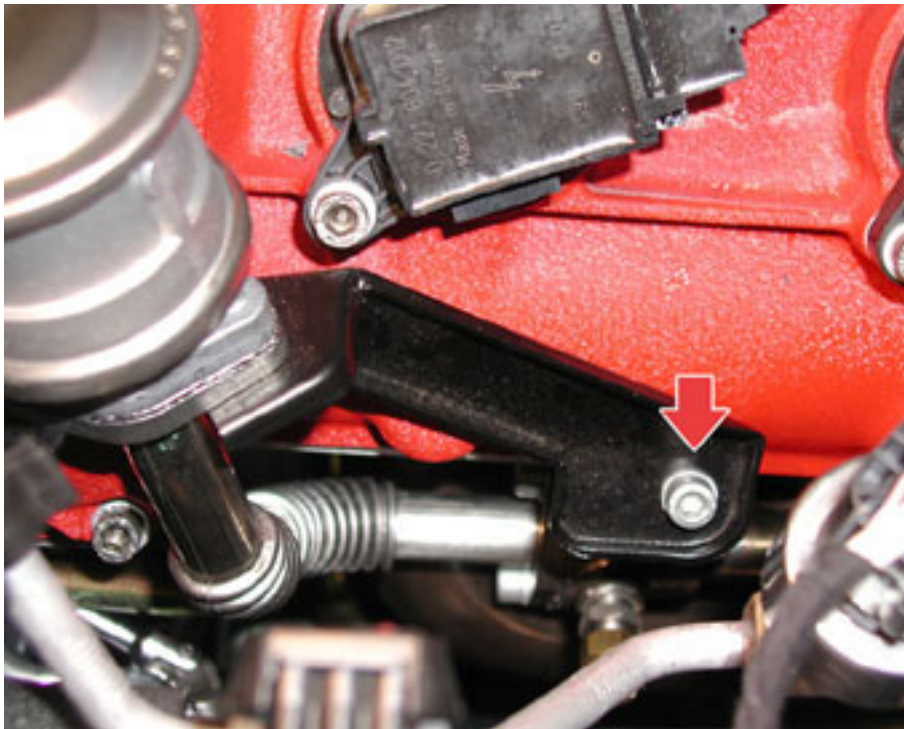

- Lift the hoist and, working from beneath the vehicle, undo the two screws fastening the valve to the air pipeline.

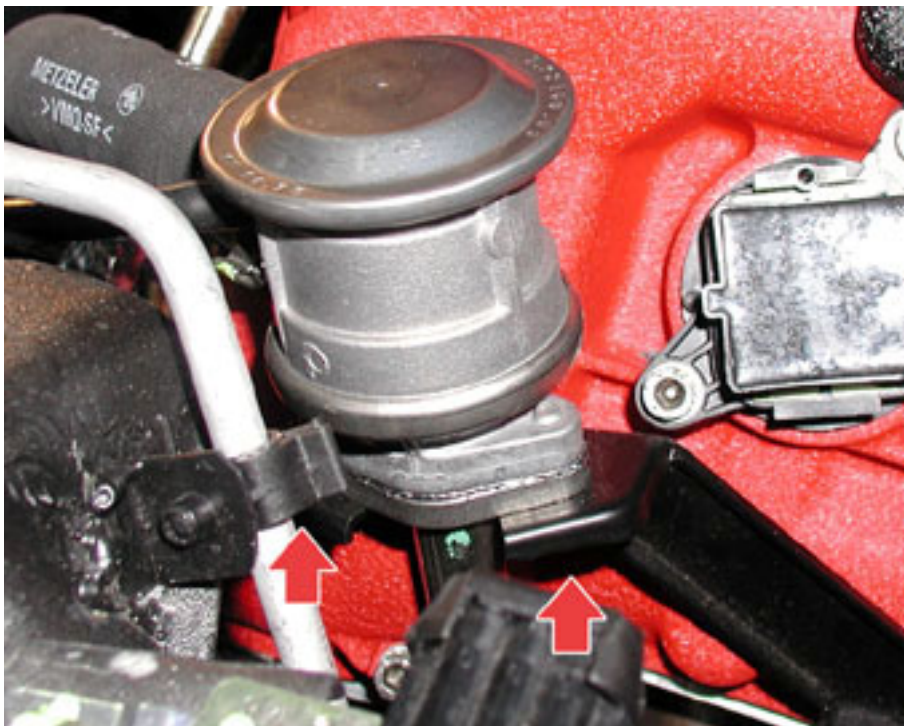

- Remove the secondary air pneumatic actuator valve complete with the gasket and support bracket.



N.B.

This procedure can also be applied to the other pneumatic actuator valve, provided that you remove the fuse box in the engine compartment and the relative support before working on the valve.

When refitting, follow the above procedures in reverse order

TIGHTENING TORQUES

DESCRIPTION	TORQUE	PRODUCT
Nut fastening bushing to gearbox	130 Nm	
Screw fastening rubber bushing to rear underframe	50 Nm	
Nut for fastening RH exhaust extension mounting brackets to gearbox	24 Nm	
Nut and stud bolt for fastening LH exhaust extension mounting brackets to gearbox	7,4 Nm	
Unions for oil coils to gearbox	34 Nm	
Unions on radiator for oil lines	34 Nm	
Nut for fastening engine/gearbox connection pipe	70 Nm	
Screw for fastening F1 to gearbox	24 Nm	
Screw for fastening F1 to gearbox	32 Nm	
Screw for fastening upper bracket to actuator	24 Nm	
Screw for fastening lower bracket to actuator	24 Nm	
Srew for fastening lower actuator bracket to differential housing	49 Nm	
Nut fastening upper actuator bracket to gearbox housing	24 Nm	
Screw for fastening F1actuator cover to gearbox	7.4 Nm	
Screw for fastening F1actuator cover to gearbox	7.4 Nm	
Nut for fastening clutch housing to crankcase	70 Nm	
Flanged screw for fastening starter motor	24 Nm	

TOOLKIT

Specific Equipment

Description	Code	
Clutch centring shaft	900026250	
Transmission line mount	900027300	
Tool for checking electronically-controlled gearbox oil level	900027330	

REMOVING-REFITTING THE CLUTCH

Clutch removal

- Remove the exhaust tailpipes.
Removing-refitting the tailpipe
- Remove the gearbox.
Removing-refitting the gearbox

ALL VERSIONS EXCEPT USA- CANADA

- Unscrew the two rear Lambda sensors on the catalytic converters and release the cables from the central fastening bracket.

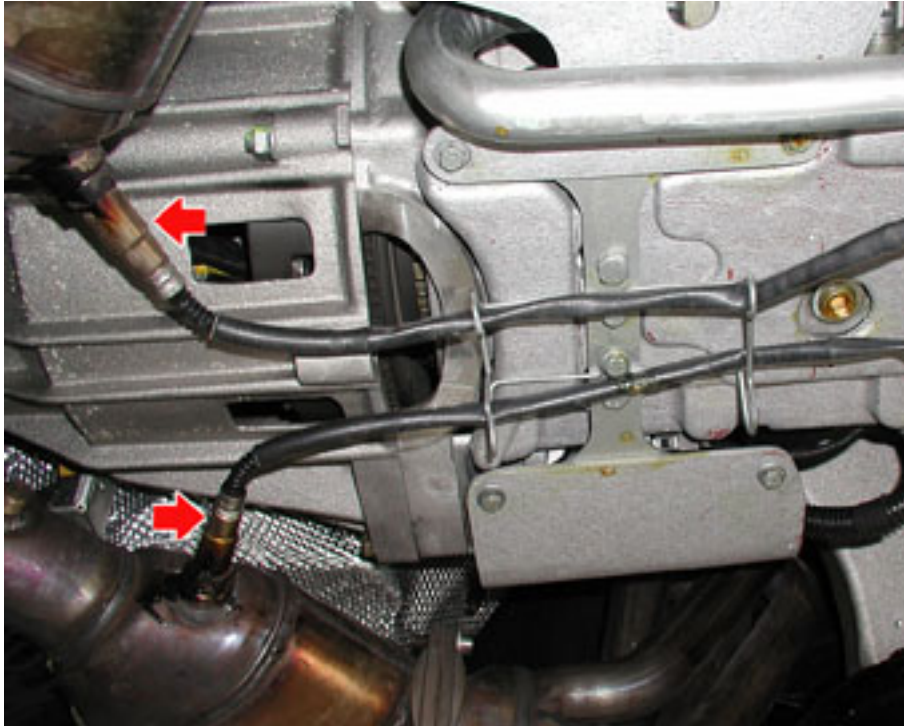

ALL VERSIONS EXCEPT USA- CANADA

- Undo the wiring fastening screws, then unscrew the Lambda sensor from the left-hand catalytic converter.

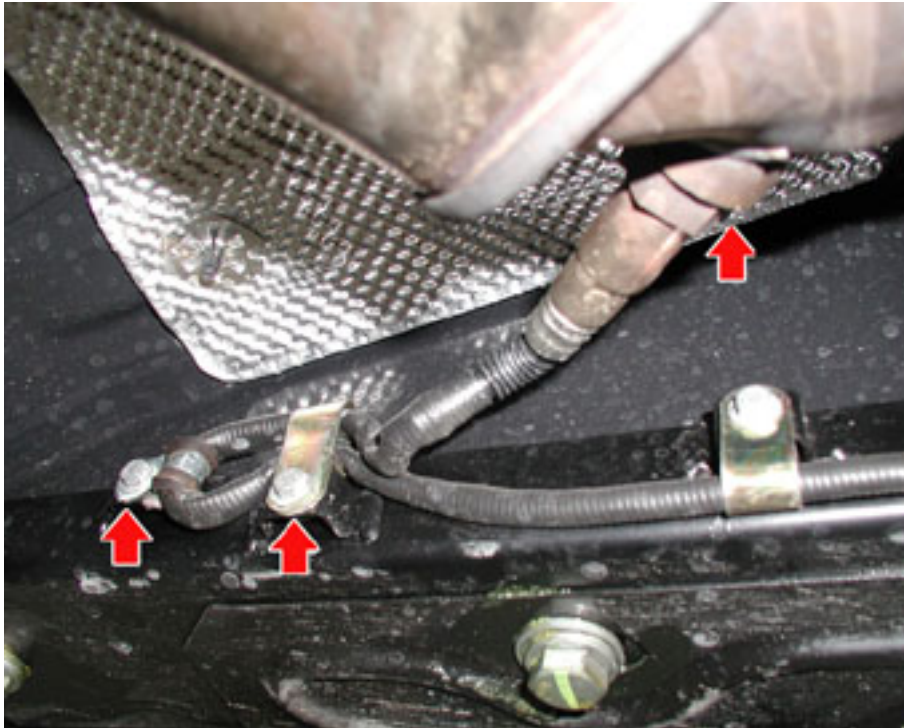

ALL VERSIONS EXCEPT USA- CANADA

- Undo the wiring fastening screws, then unscrew the Lambda sensor from the right-hand catalytic converter.

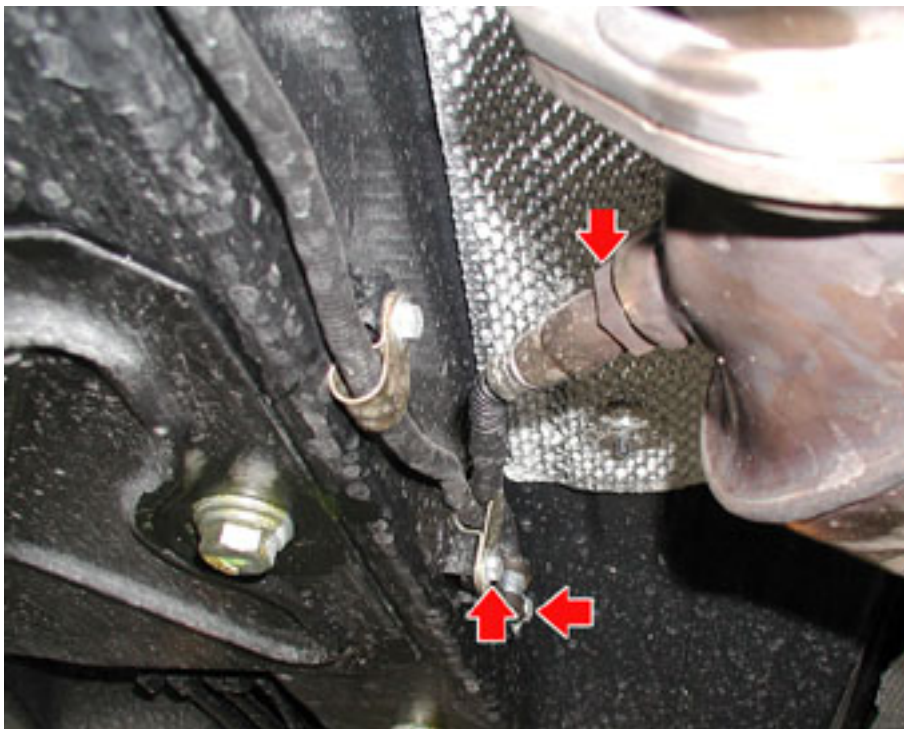

ALL VERSIONS EXCEPT USA- CANADA

- Unscrew the fastening nuts on the central catalytic converter mount.

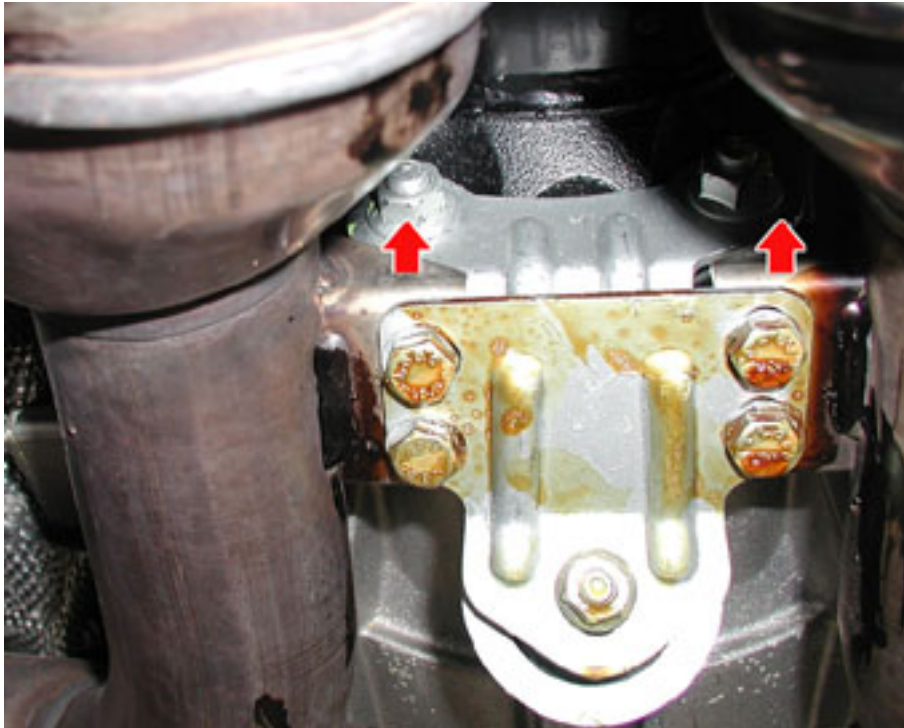

ALL VERSIONS EXCEPT USA- CANADA

- Unscrew the six screws fastening the catalytic converter to the relative manifolds.

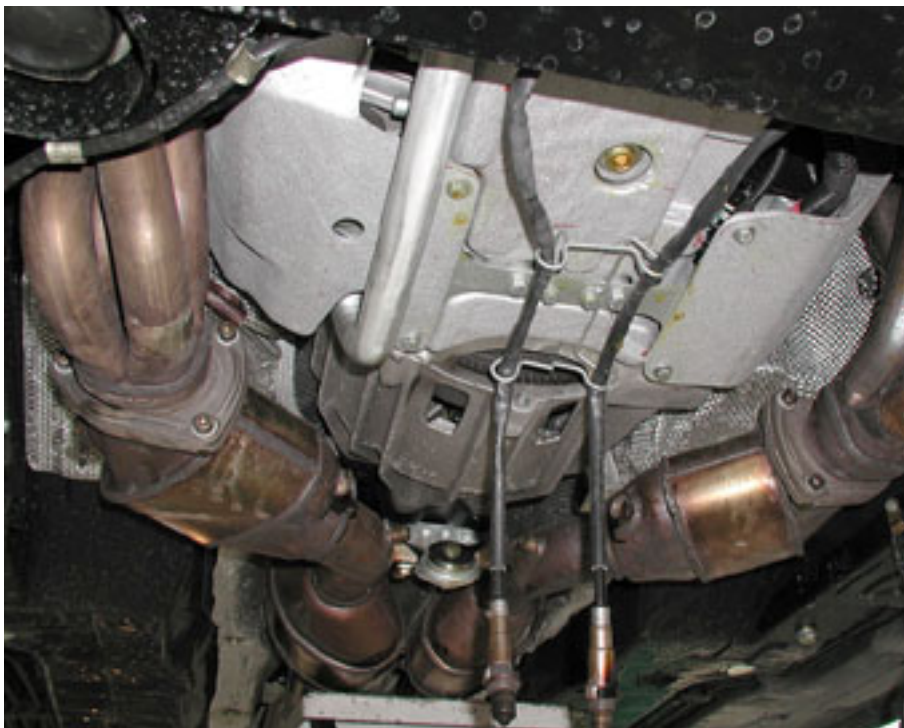

ALL VERSIONS EXCEPT USA- CANADA

- Position a hydraulic support beneath the catalytic converter/ central exhaust silencer assembly, lower it slowly, then remove the catalytic converters together with the central exhaust silencers.
- Retrieve the catalytic converter conductive gaskets.



FOR USA-CANADA VERSION ONLY

- Remove the two exhaust extensions.
Exhaust extension pipe
- Remove the central exhaust silencer.
Exhaust silencer
- Remove the floor guard beneath the engine.
Engine floor guard
- Remove the catalytic converters.
Catalytic converters

OPERATIONS VALID FOR ALL VERSIONS

- Undo the front fastening screw on the transmission shaft heat guard.

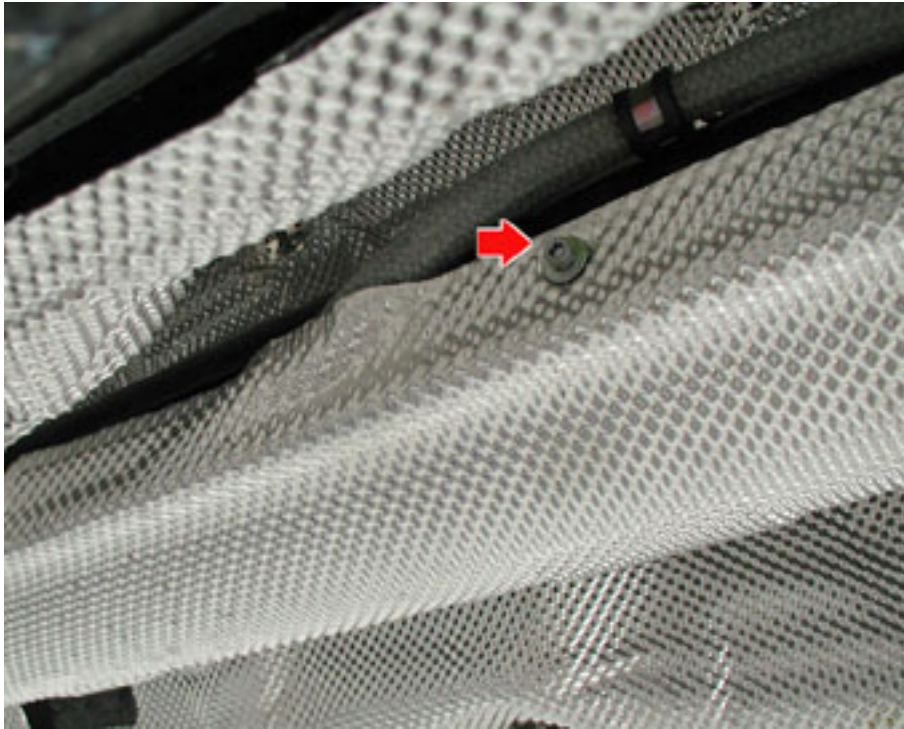

- Undo the rear fastening screws on the transmission shaft heat guard.

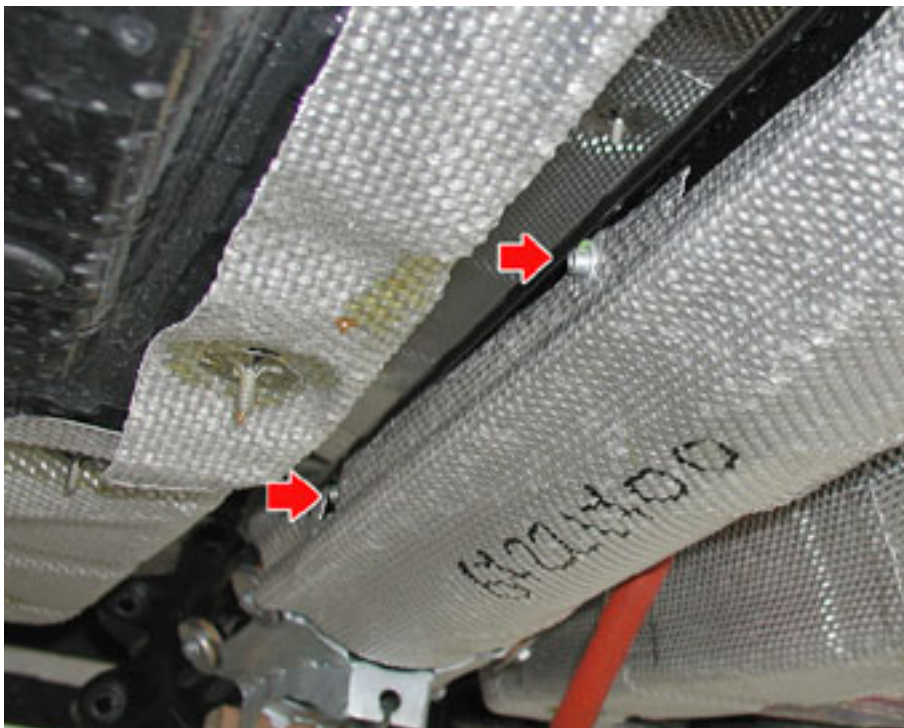

- Unscrew the nuts fastening the clutch oil line to the transmission shaft.

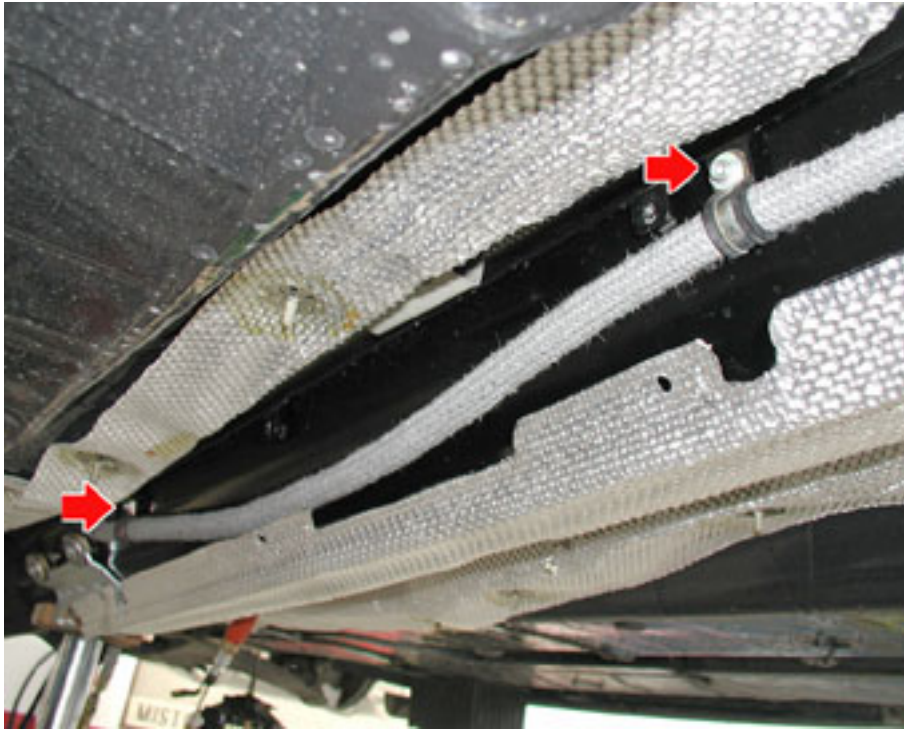

- Undo the two screws fastening the clutch oil line to the relative housing.

N.B

This operation must only be carried out on vehicles fitted with a lateral bleeding clutch housing.

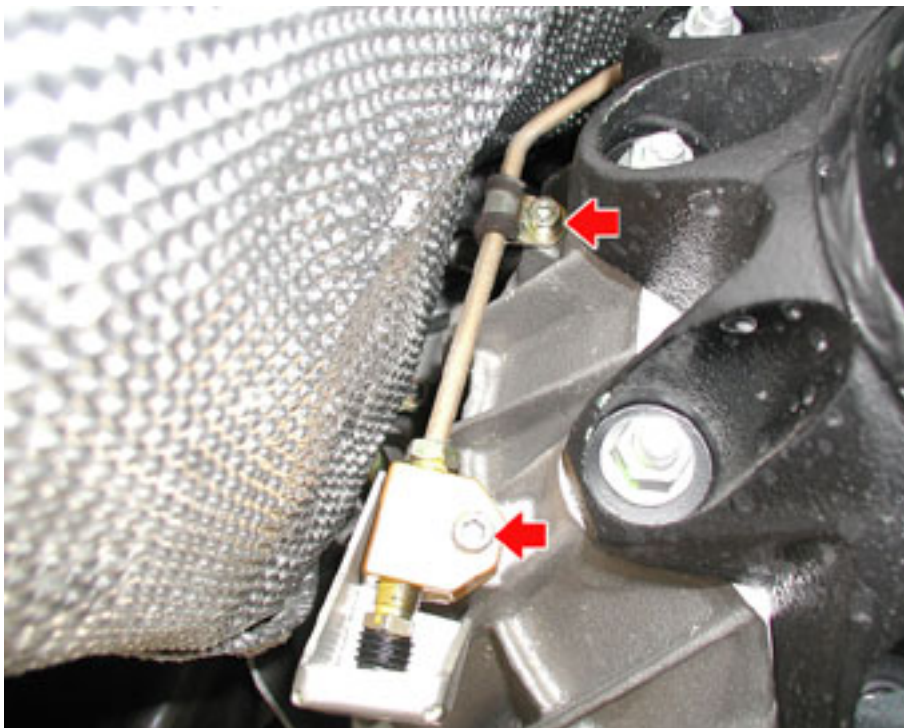

N.B

These operations must only be carried out on versions fitted with a SOFAST 3 gearbox

- Detach the clutch pressure sensor's electrical connection.



- Unscrew the nuts fastening the clutch housing to the engine.

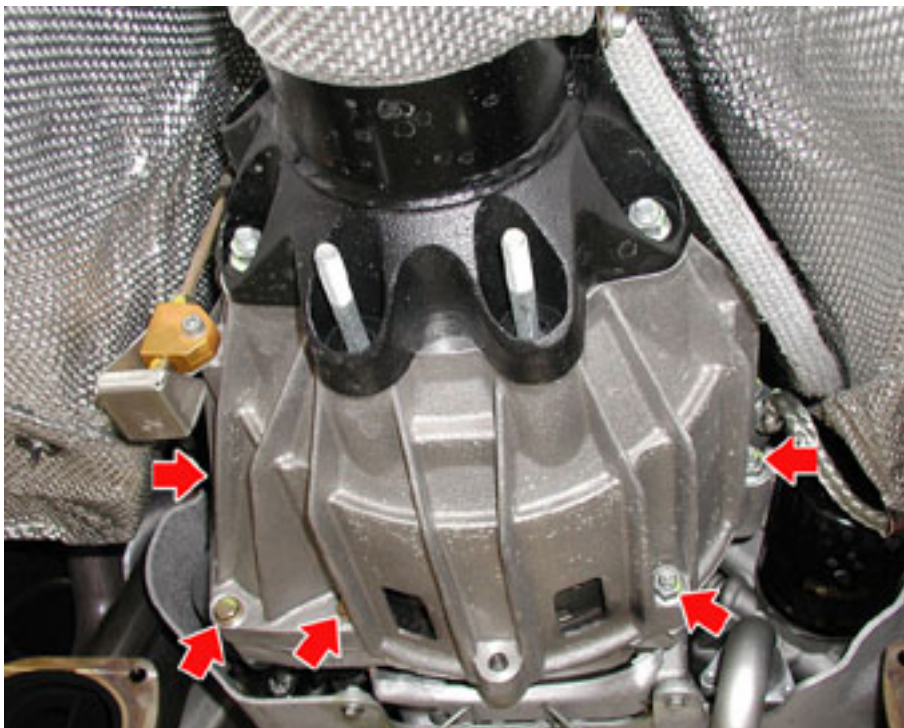

- Overview of the locations of the clutch housing fastenings.

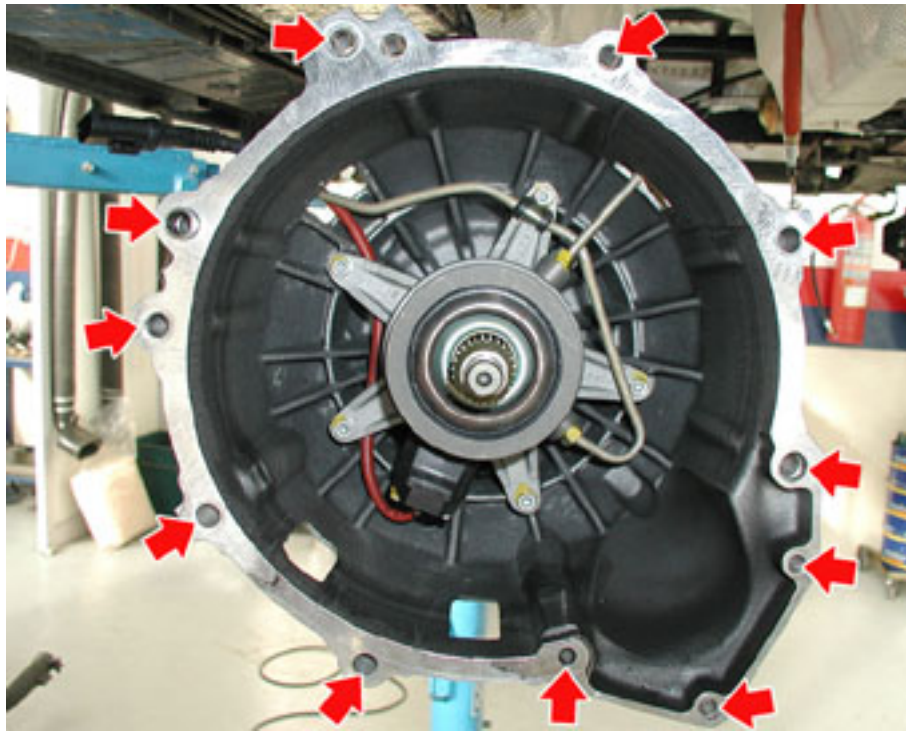

- Remove the earth cable from the clutch housing.



- Position tool **900027300**, in order to support the transmission shaft during the removal of the transmission shaft - clutch housing assembly, and remove the rear mount placed there previously during the gearbox removal operation.



- Position a hydraulic device under the engine to support it.
- Take the clutch housing out of its seat and remove the transmission shaft - clutch housing assembly.



- Loosen the six retaining screws (1,3,4,6,7,9) on the clutch pack.

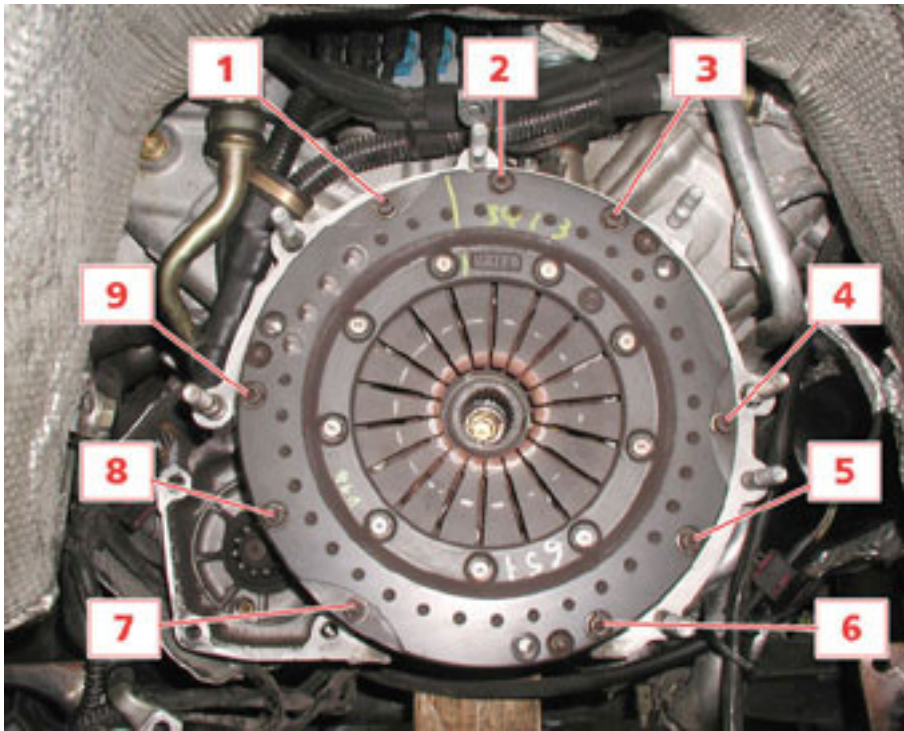

- Rotate the engine flywheel manually, bringing the mark on the flywheel (1) (maximum flywheel unbalance position) level with the mark on the clutch on the opposite side (2) (maximum clutch unbalance position).

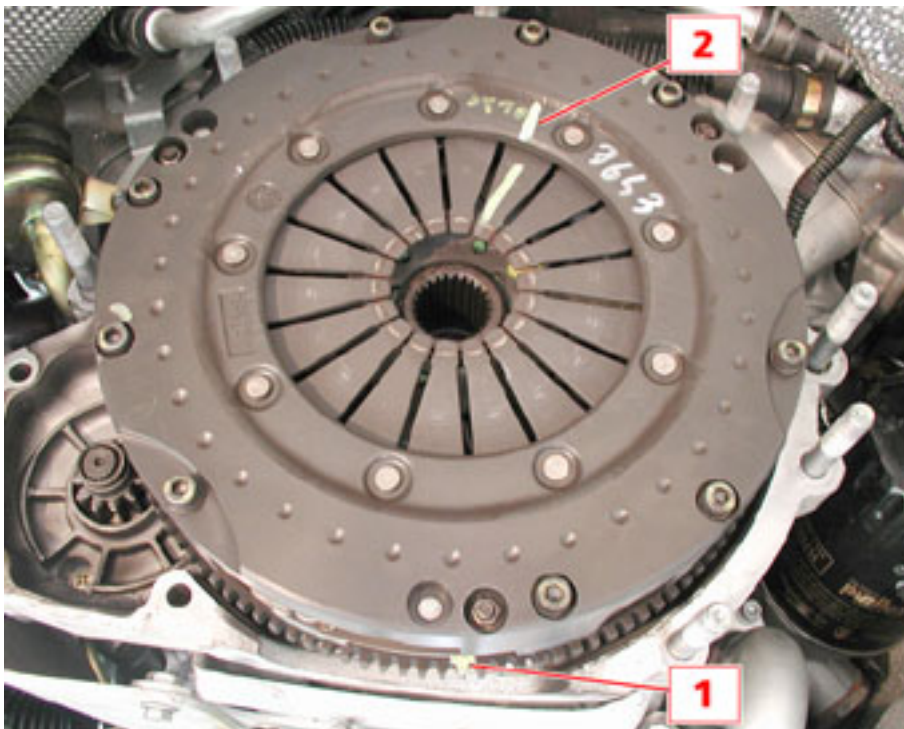

- Position the centring shaft **900026250** on the clutch pack.
- Mark the positions of the screws (**1,7,4**), and their spacers, as they act as counterweights
- Undo the remaining retaining screws (**2,5,8**) (**previous Figure**)

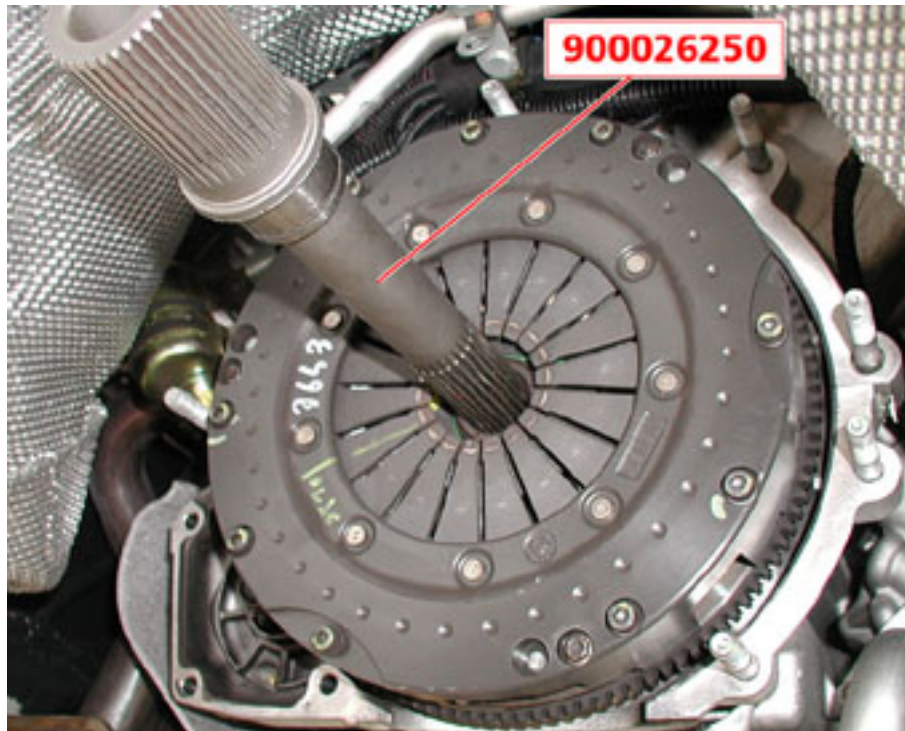

- Remove the complete clutch.



Refitting the clutch

- Fit the clutch assembly in its seat on the flywheel using the clutch centring tool **900026250**.

IMPORTANT

If refitting a clutch unit which has been previously removed from the car, follow the markings made during its removal.

N.B.

The clutch disk is supplied by the manufacturer with the maximum unbalance point marked.

IMPORTANT

If fitting a new clutch disk, its maximum unbalance point must be oriented at 180° with respect to the maximum unbalance point of the flywheel.

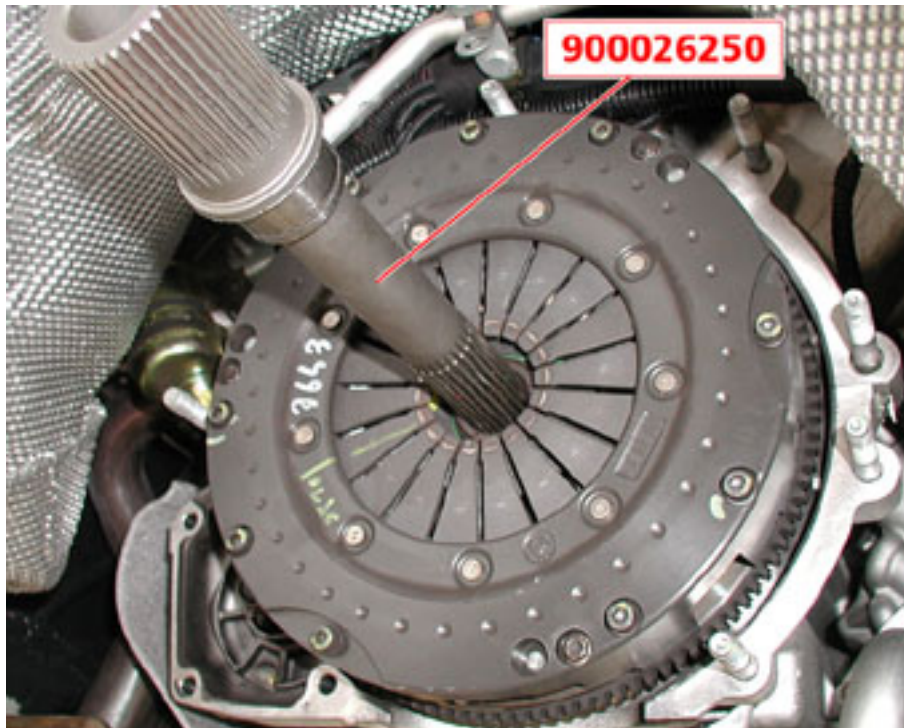

- Tighten the nine screws securing the clutch to a torque of **18Nm**, in a crosswise sequence.

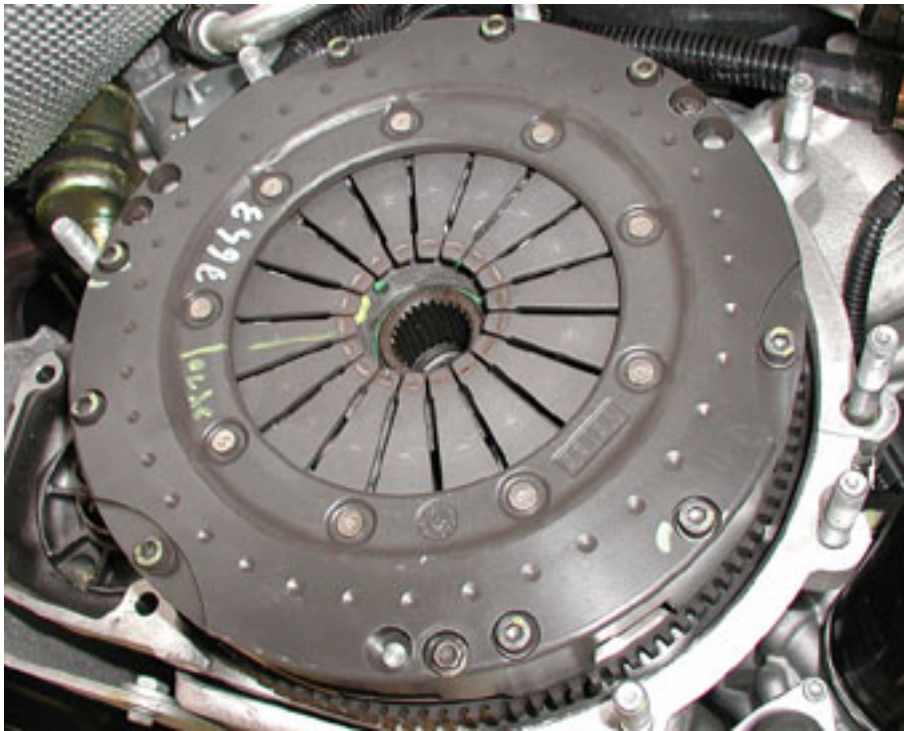

- Apply a layer of water-repellent grease to the grooved profile of the thrust bearing and to the centring two dowels on the clutch housing.



- Using tool **900027300**, fit the transmission shaft - clutch housing assembly in its seat on the engine.



- Connect the earth cable to the clutch housing.
- Tighten the nuts fastening the clutch housing to the engine to a torque of **70 Nm**.

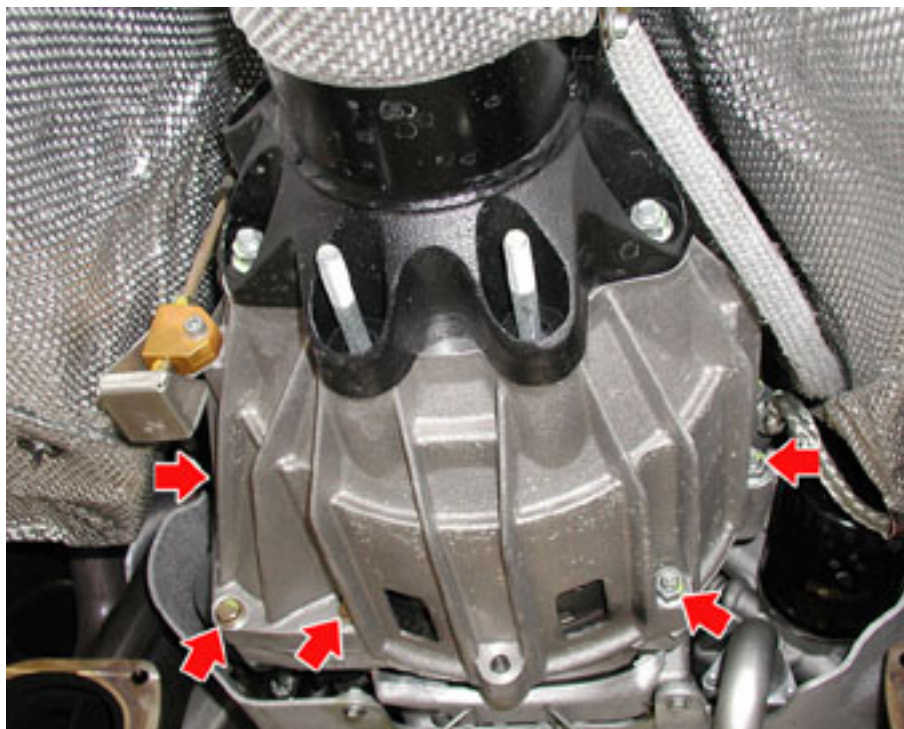

- Remove the lifting device placed under the engine earlier and position it beneath the rear end of the rear transmission.
- Remove tool **900027300** from beneath the transmission shaft.
- Tighten the nuts fastening the clutch oil line to the transmission shaft, then tighten the fastening screws on the heat guard.

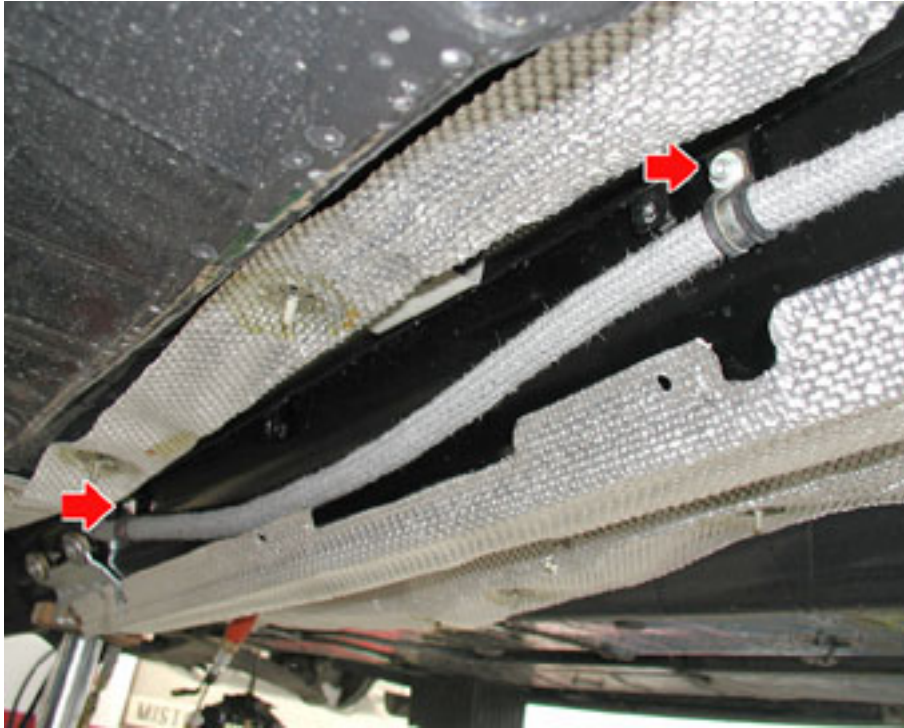

ALL VERSIONS EXCEPT USA- CANADA

- Using a hydraulic support positioned underneath the catalytic converter/central exhaust silencer assembly, position the catalytic converters in their seat together with the central exhaust silencers.

N.B.

VISUALLY INSPECT THAT THE GASKET LOCATED BENEATH THE FLANGE JOINING THE CATALYTIC CONVERTER TO THE EXHAUST MANIFOLD IS INTACT. IF WORN, REPLACE IT.

N.B.

THE CONDUCTIVE GASKETS MUST NEVER BE FITTED MORE THAN ONCE. THE SECOND TIME THE COMPONENT IS FITTED, THEY MUST BE REPLACED

- Fit the conductive gaskets.



ALL VERSIONS EXCEPT USA- CANADA

- Tighten the screws fastening the exhaust manifold to the catalytic converter to a torque of **25 Nm**.

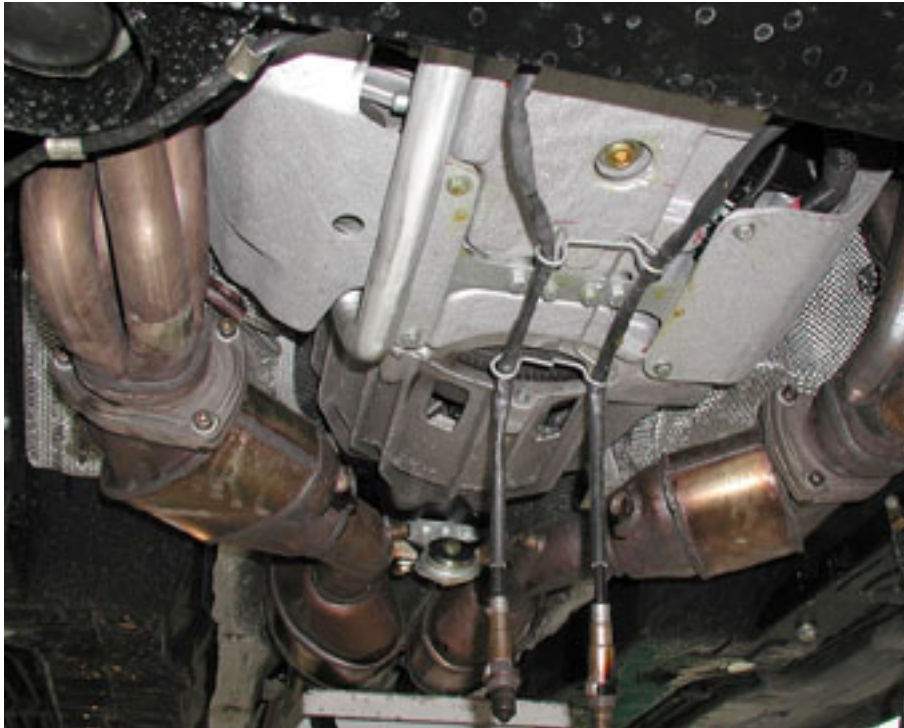

ALL VERSIONS EXCEPT USA- CANADA

- Tighten the fastening nuts on the central catalytic converter mount.

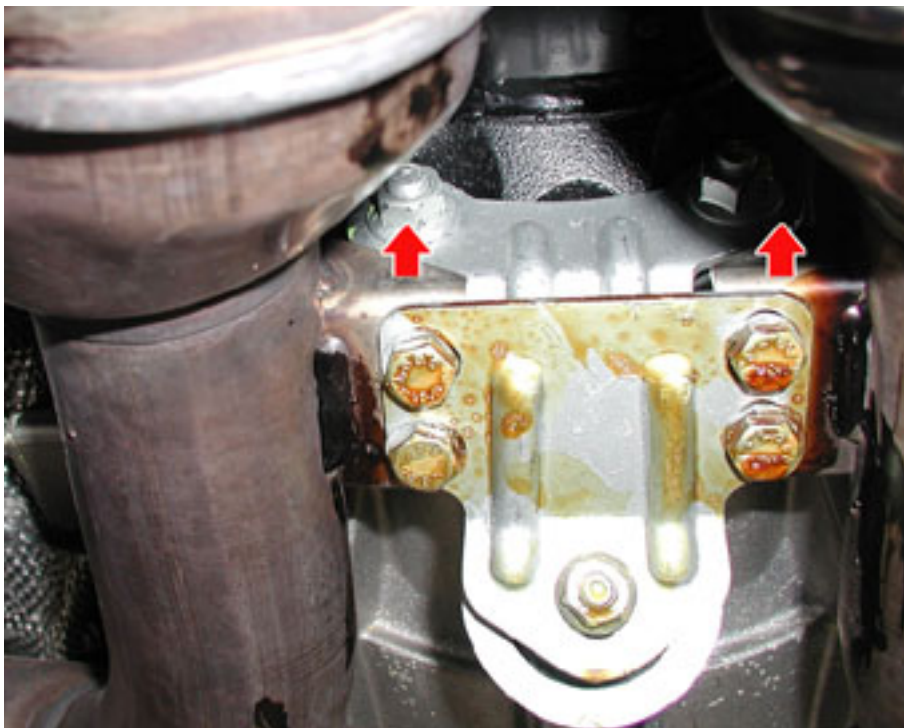

ALL VERSIONS EXCEPT USA- CANADA

- Fit all the Lambda sensors, then tighten them to a torque of **10Nm**.
- Suitably secure the front Lambda sensor wiring to the engine frame.

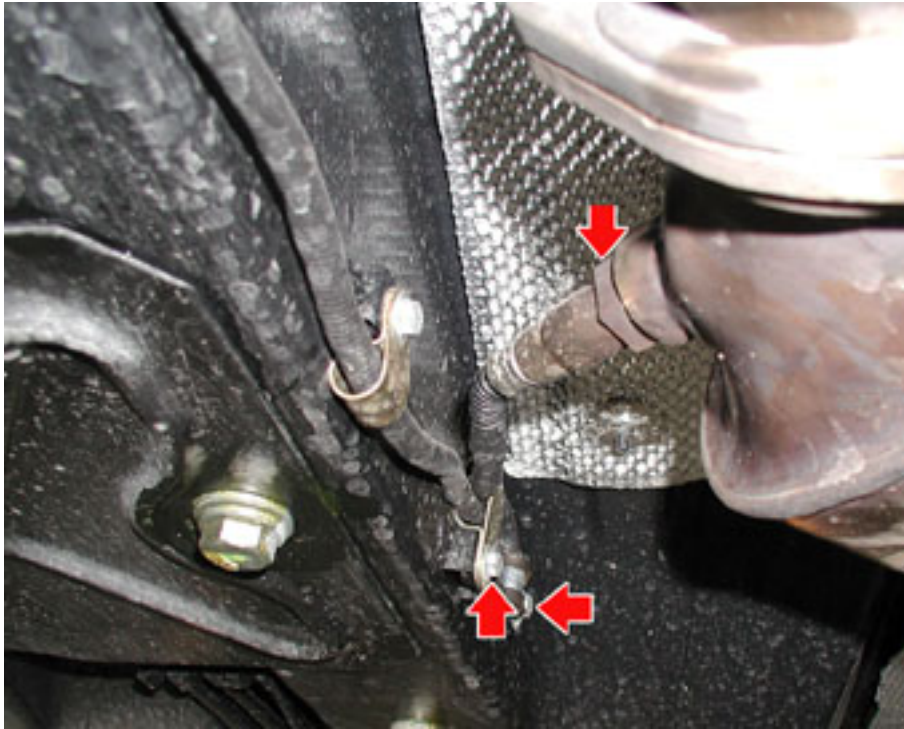

FOR USA-CANADA VERSION ONLY

- Refit the catalytic converters.

Catalytic converters

- Refit the engine floor guard.

Engine floor guard

- Refit the central exhaust silencer.

Exhaust silencer

- Refit the two exhaust extension pipes.

Exhaust extension pipe

ALL VERSIONS

- Proceed by refitting the gearbox.

Removing-refitting the gearbox

- Proceed by refitting the exhaust tailpipes.

Removing-refitting the tailpipe

- Proceed by bleeding the clutch's hydraulic system.

Bleeding the clutch

- Carry out the KISS POINT (PIS) adjustment procedure.

Kiss point (PIS) adjustment procedure

- You must also run the following procedure using the SD3 tester:
 - New clutch setting.

N.B

This operation must only be carried out on versions fitted with the SOFAST 3 gearbox

- If the clutch unit is replaced, the self-calibration procedure for the DEIS parameters must be performed
- ##### *DEIS parameter self-calibration*
- You must also run the following procedure using the SD3 tester:
 - Wear index reset.

BLEEDING THE CLUTCH

After replacing the system components, bleed the air from the circuit.

IMPORTANT

1. During the bleeding phase, keep checking the oil level in the tank: this must never fall below the "MIN" level
 2. Never re-use the oil which has leaked from the system
- This operation requires the use of the special SD3 95970312 tester.

N.B

This operation must only be carried out on vehicles fitted with a lateral bleeding clutch housing.

- Slacken off the bleed union on the LH side of the clutch housing and connect a small pipe to drain any excess oil which leaks during bleeding into a special pan

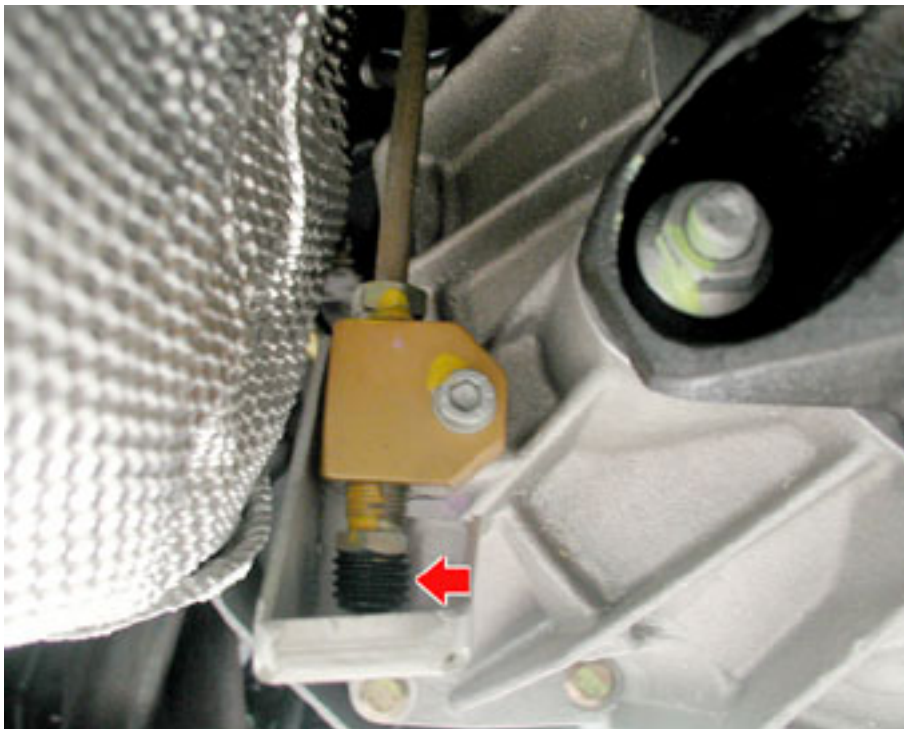

N.B

This operation must only be carried out on vehicles fitted with lower or central bleeding clutch housings.

- The bleeding cap located in the central and lower section of the clutch housing must be loosened and a small pipe fitted there to allow the excess oil drained out to be collected in a suitable container.



N.B

These operations are valid for all clutch housing versions

- Using the SD3 tester, start the clutch bleeding procedure by pouring oil into the electronically-controlled gearbox oil tank continually, so that no air can enter.
- The bleeding procedure ends when there is no air left in the oil flowing out the bleeding point.
- Using the SD3 tester, operate the gearbox, engaging a series of gears to check that the pump is working correctly.
- To work properly, the pump must NOT be working all the time. If it remains on, suspend the gear shifting sequence and start the bleeding procedure once again, as there may still be some air remaining in the system.
- Upon completion of the cycle, check the Power Unit oil level.

Establishing the oil tank level for the Power Unit (electronically controlled gearbox)

N.B

This operation must only be carried out on versions fitted with the SOFAST 3 gearbox

- We recommend you carry out the DEIS adjustment procedure.

DEIS adjustment procedure

CLUTCH THRUST BEARING

Clutch thrust bearing removal

- Remove the clutch housing
Clutch removal

N.B

This operation must only be carried out on vehicles fitted with a lateral bleeding clutch housing.

- Unscrew the lower union (1) on the thrust bearing block.
- Unscrew the upper union (2) on the thrust bearing block.
- Remove the five fastening screws (3) from the thrust bearing unit
- Extract the thrust bearing unit (4) from the clutch housing

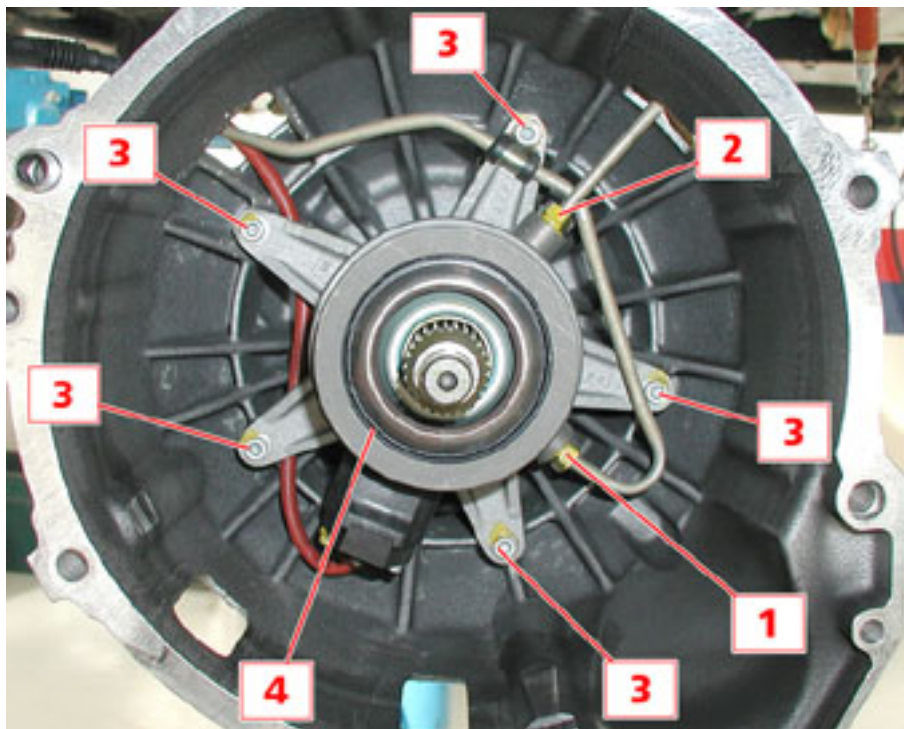

N.B

This operation must only be carried out on vehicles fitted with lower or central bleeding clutch housings with a new thrust bearing.

- Unscrew the lower union (1) on the thrust bearing block.
- Unscrew the upper union (2) on the thrust bearing block.
- Cut the clamp (3).
- Undo the fastening screws on the thrust bearing unit
- Extract the thrust bearing unit (4) from the clutch housing

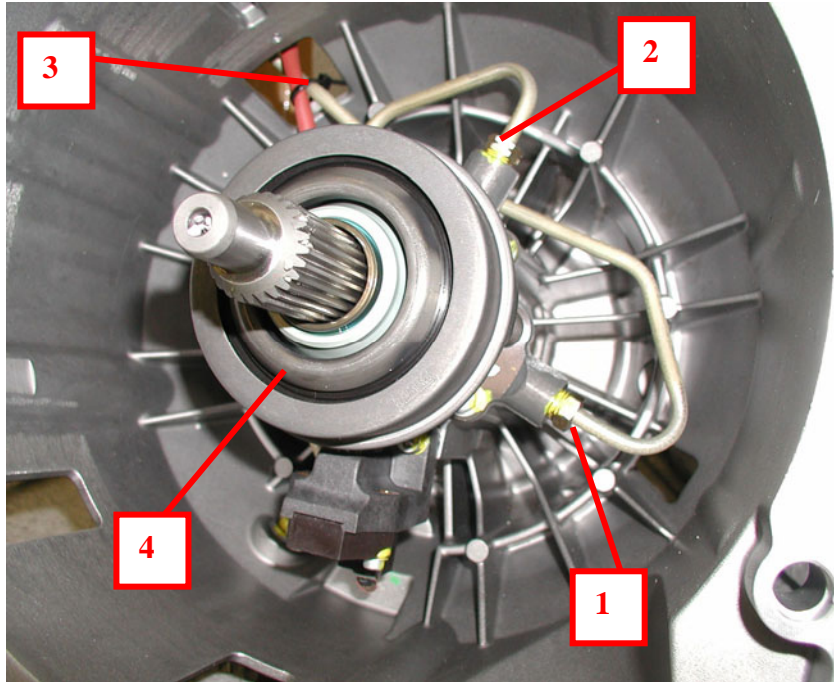

N.B

The procedure below illustrates how to remove one of the two thrust bearings, however the same procedure applies to both types.

- Undo the two fastening screws to remove the lower element



- With the thrust bearing unit on bench, unscrew the four fastening screws.



- Unscrew the two fastening pins.



- Detach the steering column from the thrust bearing; keep the two springs and pins.



Refitting the clutch thrust bearing

- Insert the thrust bearing into the steering column.



- Tighten the two fastening pins to torque.



- Tighten the two fastening screws to torque.



- Refit the lower element and tighten the two fastening screws to torque.



N.B

This operation must only be carried out on vehicles fitted with a lateral bleeding clutch housing.

- Insert the thrust bearing unit **(1)** into the clutch housing
- Tighten the five fastening screws **(2)** on the thrust bearing unit to torque.
- Tighten the upper union **(3)** on the thrust bearing block to torque.
- Tighten the lower union **(4)** on the thrust bearing block to torque.

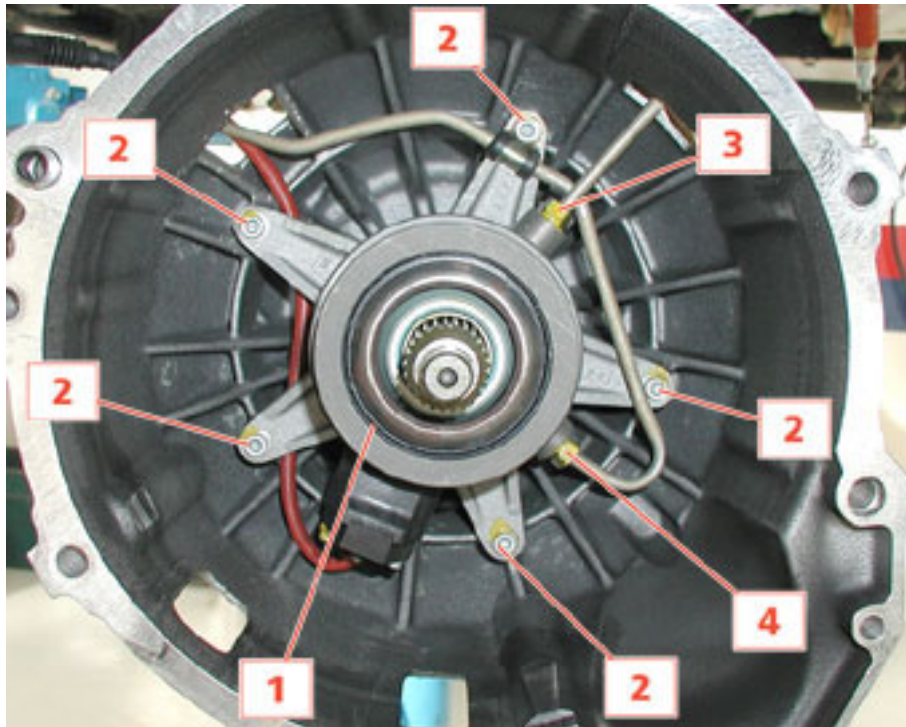

N.B

This operation must only be carried out on vehicles fitted with lower or central bleeding clutch housings with a new thrust bearing.

- Insert the thrust bearing unit (1) into the clutch housing
- Tighten the five fastening screws on the thrust bearing unit to torque.
- Position the electrical cables correctly and fasten them with a new clamp (2).
- Tighten the upper union (3) on the thrust bearing block to torque.
- Tighten the lower union (4) on the thrust bearing block to torque.

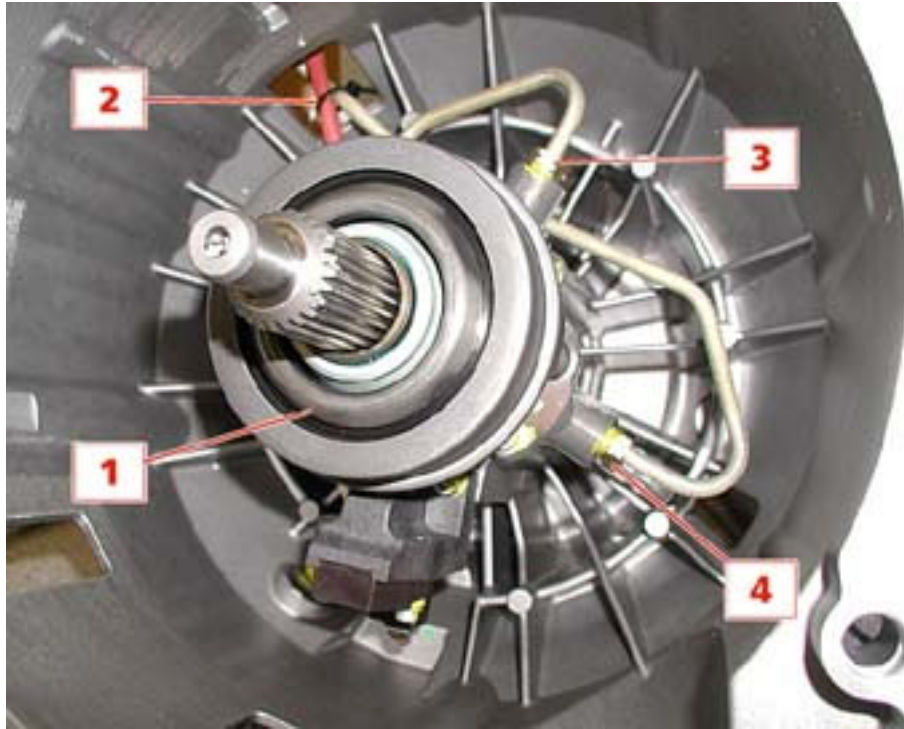

- Mount the clutch housing.

Refitting the clutch

ADJUSTING THE CLUTCH SENSOR MAGNET

- Remove the clutch housing

Clutch removal

- Undo screws **(1)**.
Slide the mount **(2)** out in the direction indicated without removing the sensor **(3)**.

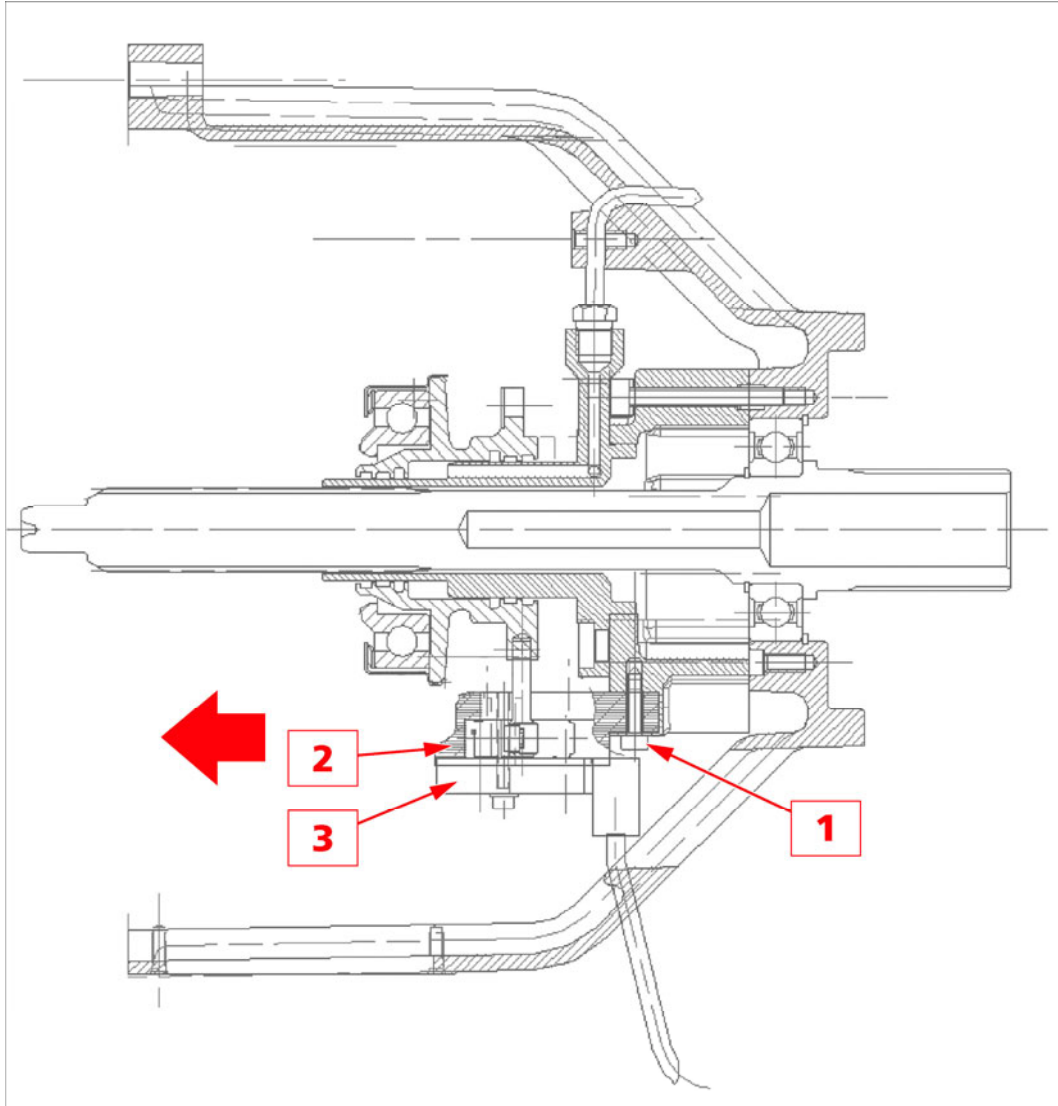

- Undo the stud bolts **(4)**.
- Extract the thrust bearing **(5)** taking care not to damage the inner grommets.
- Remove the springs **(6)** and the spacers **(7)**.

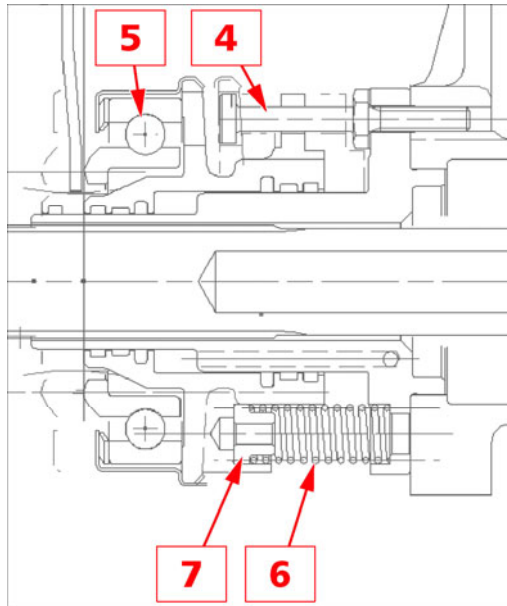

- Remove the pin **(8)** from the thrust bearing
- Rotate the magnet mount **(9)** by 180°.
- Re-insert the pin **(8)**.

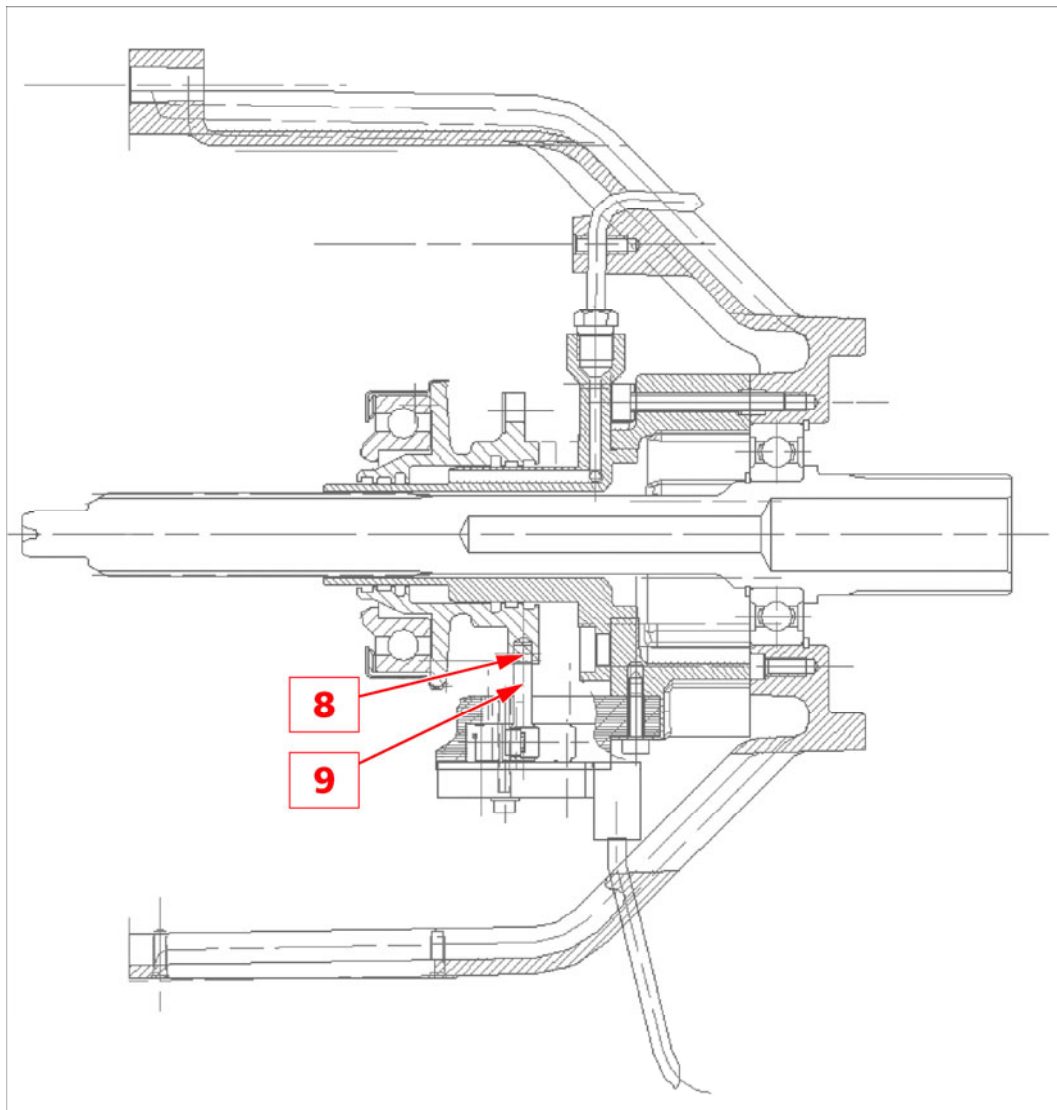

- Dampen the thrust bearing seals (10) with oil from the gearbox actuator unit.
- Carefully slip the thrust bearing over the sliding flange inserting the springs (11) and the spacers (12).

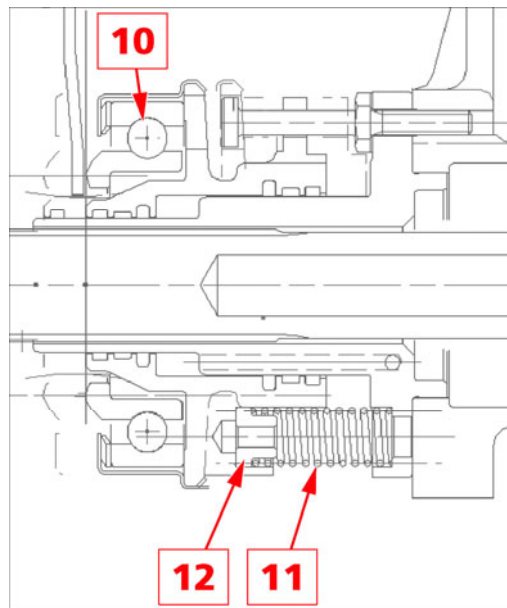

- Tighten the stud bolts (13) to 7.4 Nm, fitting the washers (14) and the washers (15).

N.B.

For all the fastenings use Loctite medium thread brake.

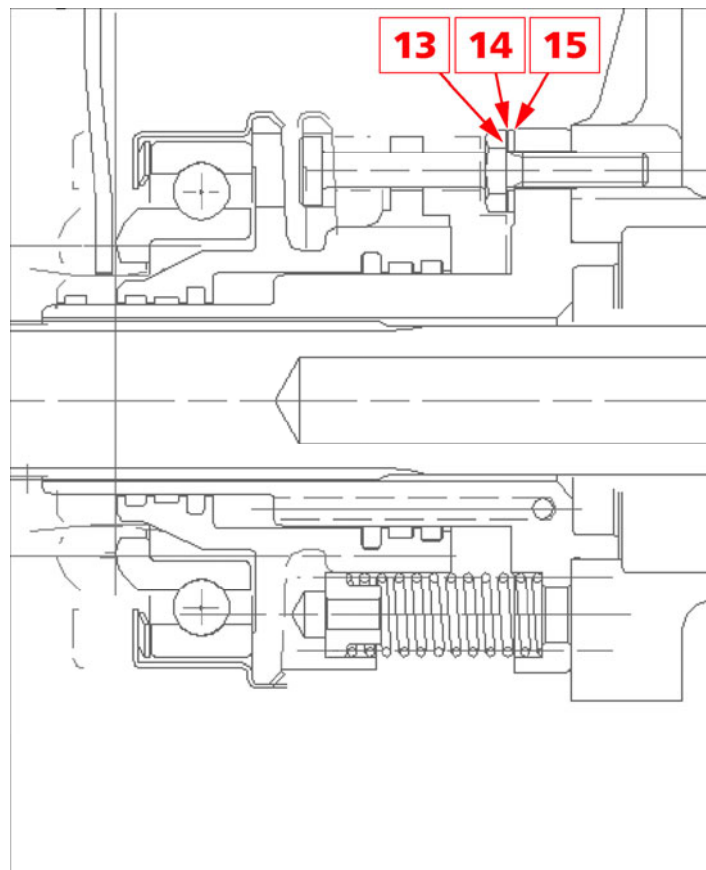

- Fit the mount (16).
- Tighten the screws (17) to 1.2 Nm.

N.B.

For all the fastenings use Loctite medium thread brake.

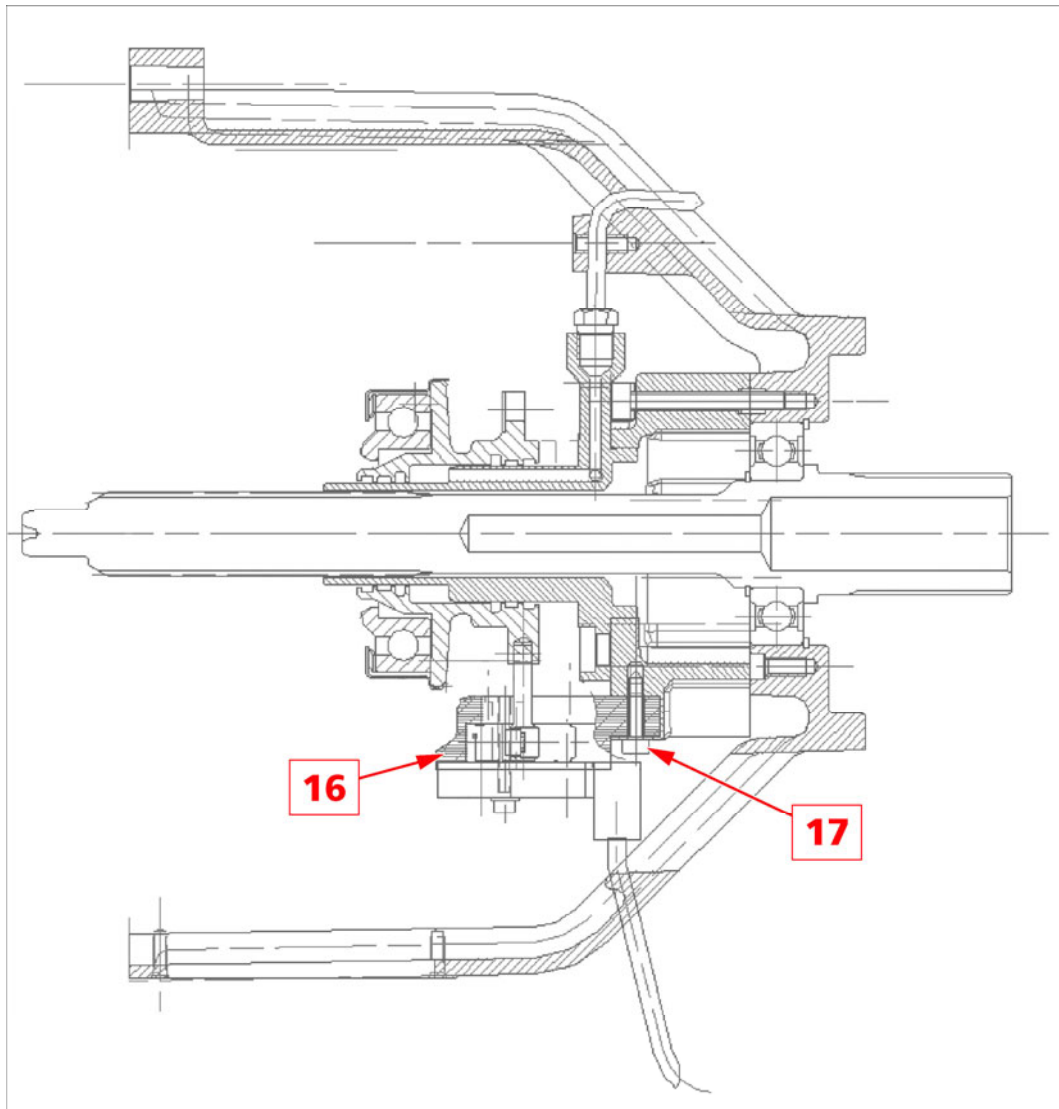

- Mount the clutch housing.
Refitting the clutch

REMOVING-REFITTING THE GEARBOX

- Disconnect the battery's negative terminal.
- Place the car on the hoist.
- Remove the exhaust tailpipes.

Removing-refitting the tailpipe

- Undo the fastening screws and remove the heat guard on the left-hand exhaust line.

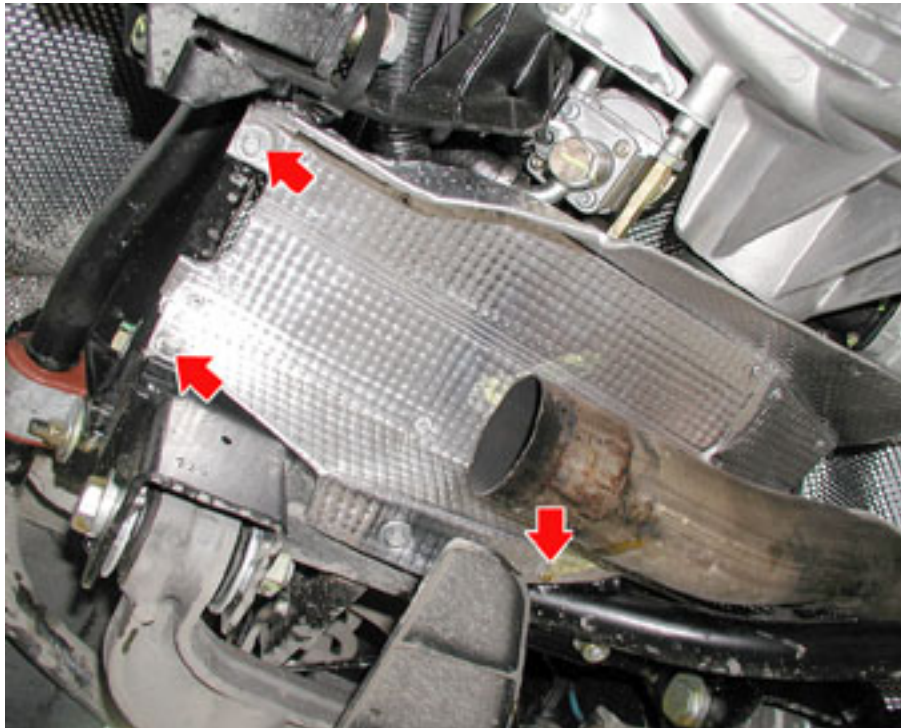

- Undo the fastening screws and remove the heat guard on the right-hand exhaust line.

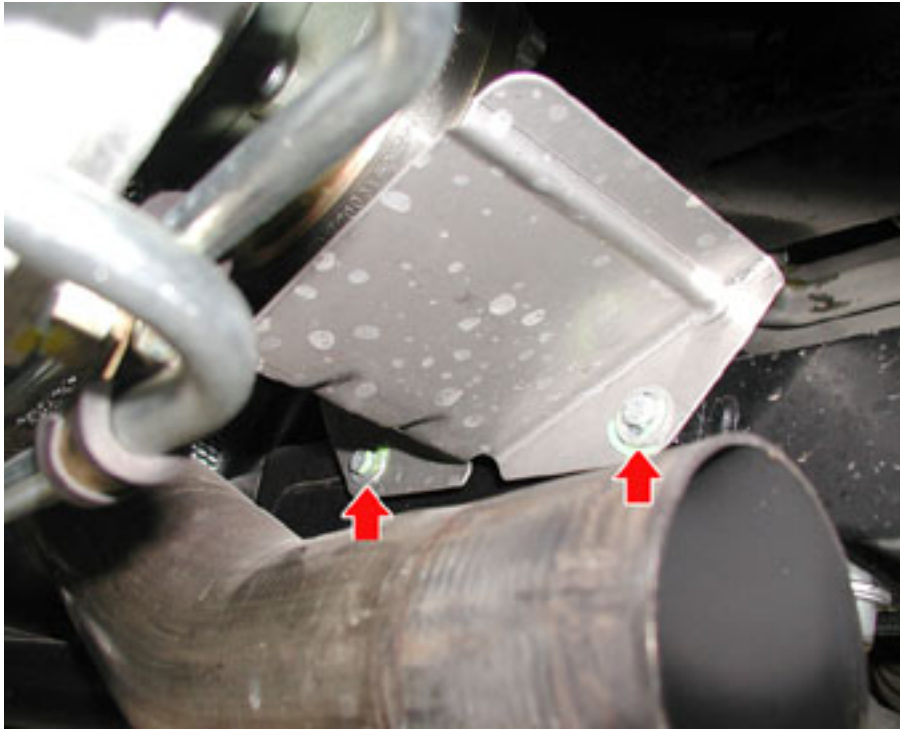

- Unscrew the nuts fastening the mount for the right-hand exhaust extension to the bodywork.
- Carry out the same operation for the left-hand exhaust extension by undoing the screws fastening the extension pipe to the bodywork.



- Unscrew the two nuts fastening the metal clamps joining the exhaust tailpipes and central silencers.



- Remove the two exhaust extensions.



- Detach the three electric connectors.

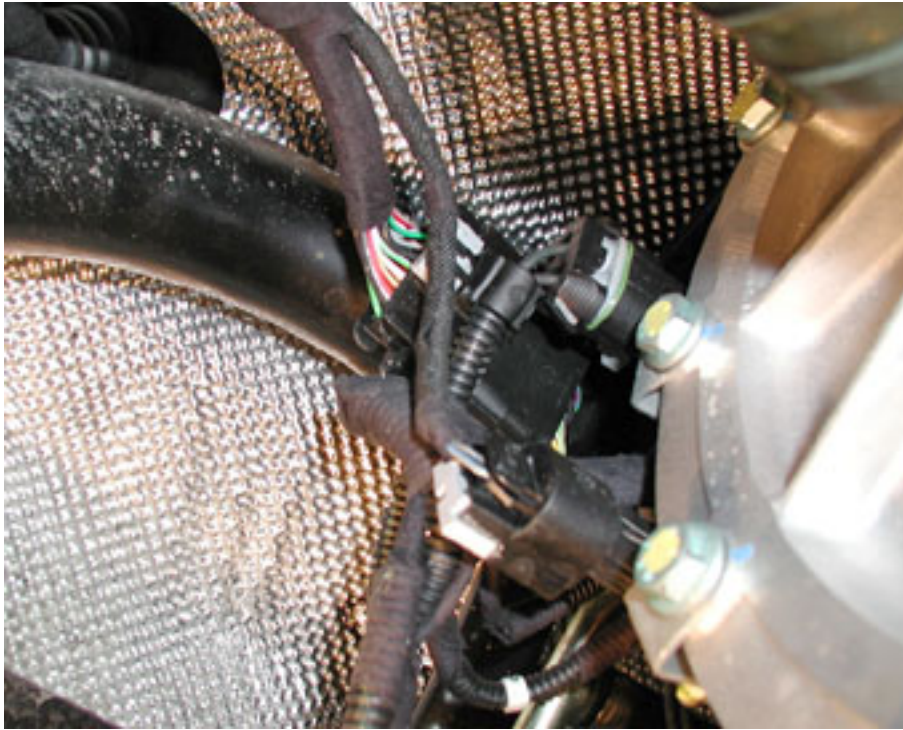

- Undo the screw fastening the electric connector to the chassis.



- Undo the nut and the check nut used to fasten and adjust the handbrake cable.



- Remove the plastic retaining clamp from its seat on the handbrake clamp, then release the handbrake cable from the bracket.

N.B.

Make sure you do not break the plastic clamp

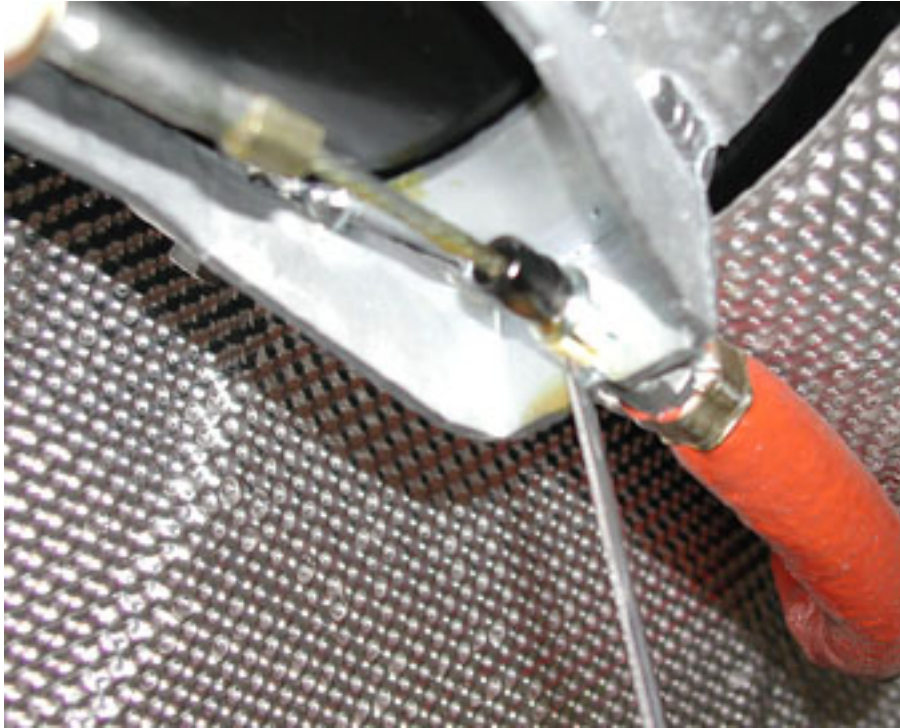

- Remove the spacer.

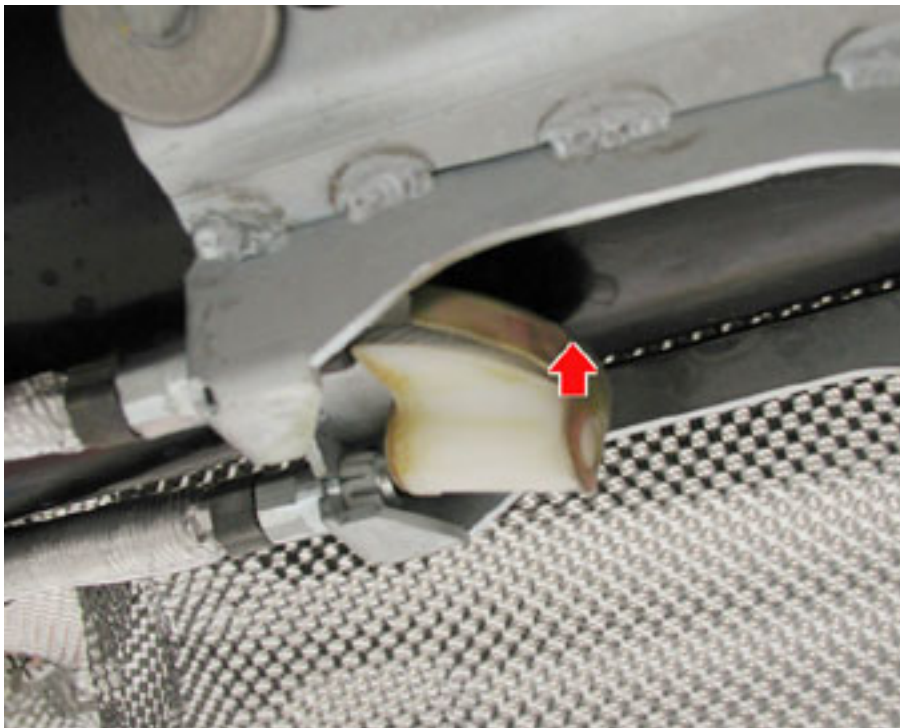

- Remove the plastic handbrake cable retaining clamps from their seat.

N.B.

Make sure you do not break the plastic clamps



- Unscrew the nut, remove the bracket and take the handbrake cables out the mount.

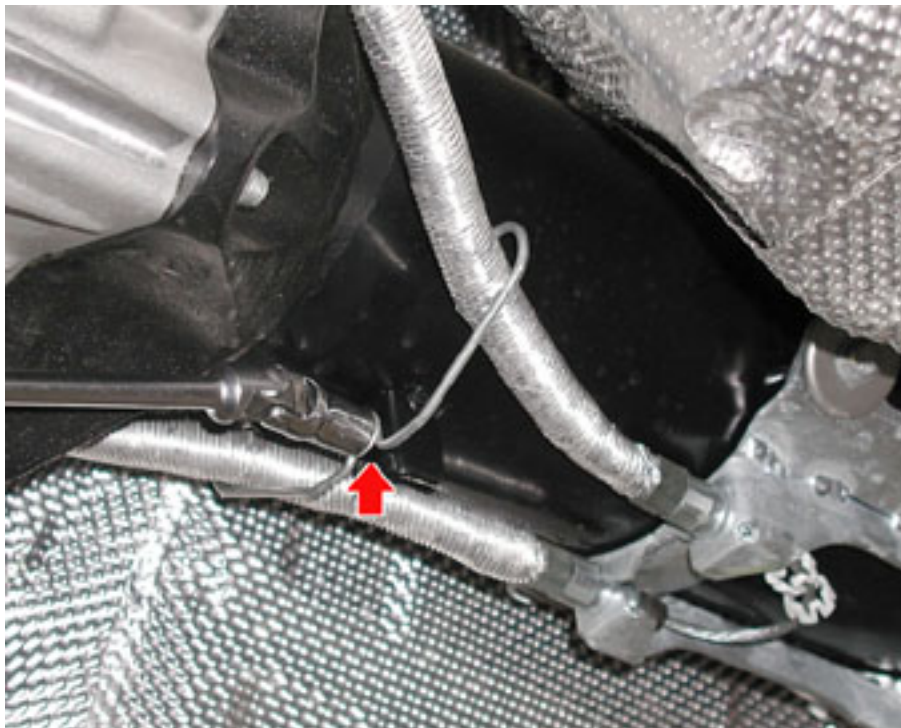

- Undo the lower fastening screws and remove the bodywork reinforcement bracket.

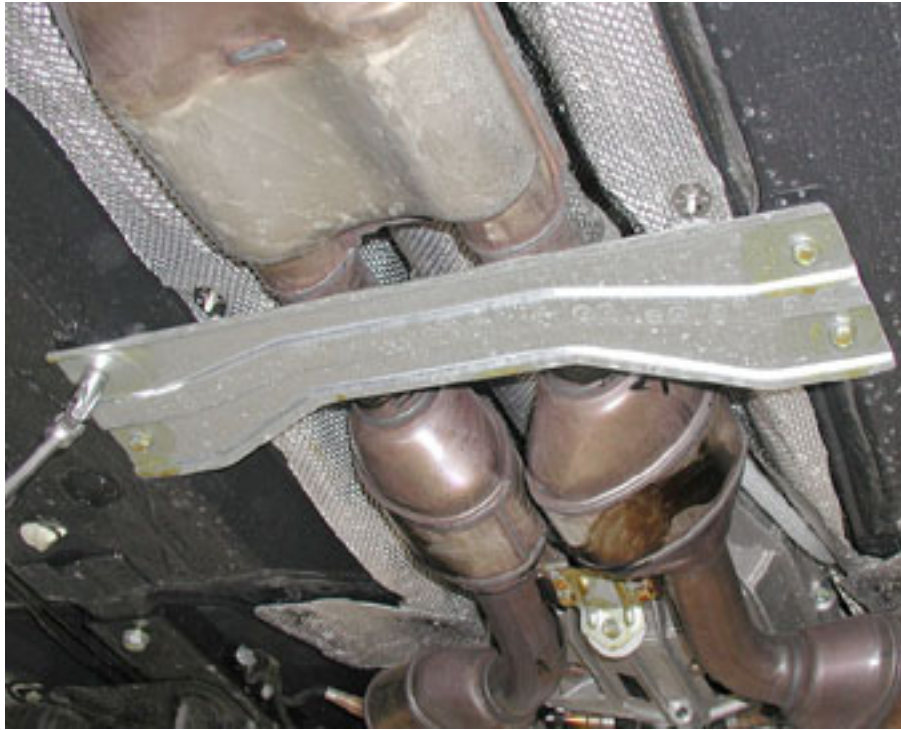

- Undo the fastening screws and remove the bodywork reinforcement bracket located between the transmission shaft and the central silencers.

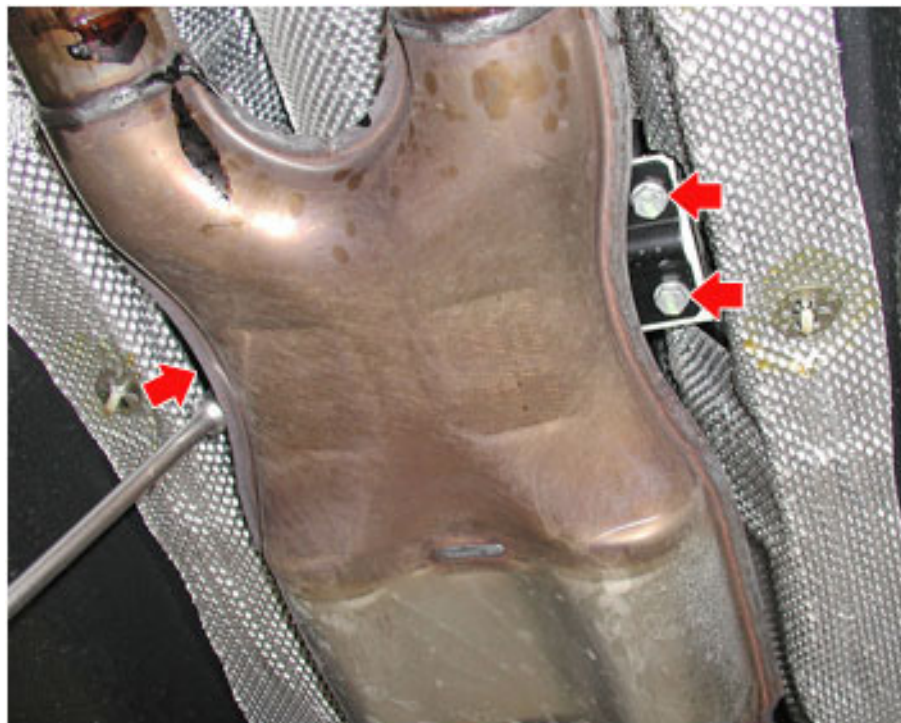

Undo the screws fastening the right- and left-hand axle shafts to the gearbox.

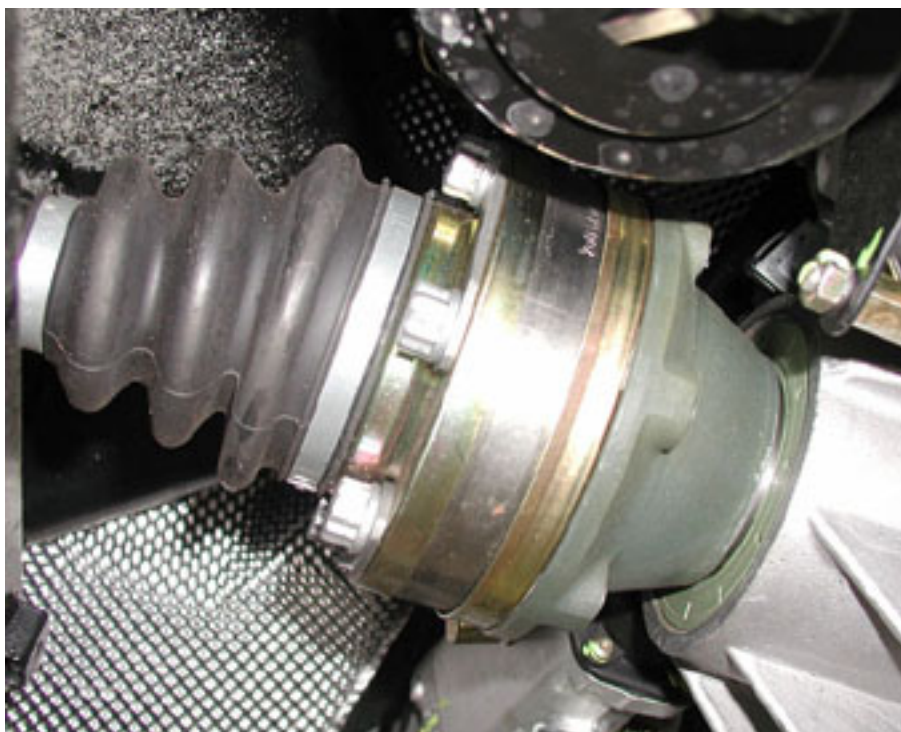

- Undo the fastening screw on the electronically-controlled gearbox oil line bracket.

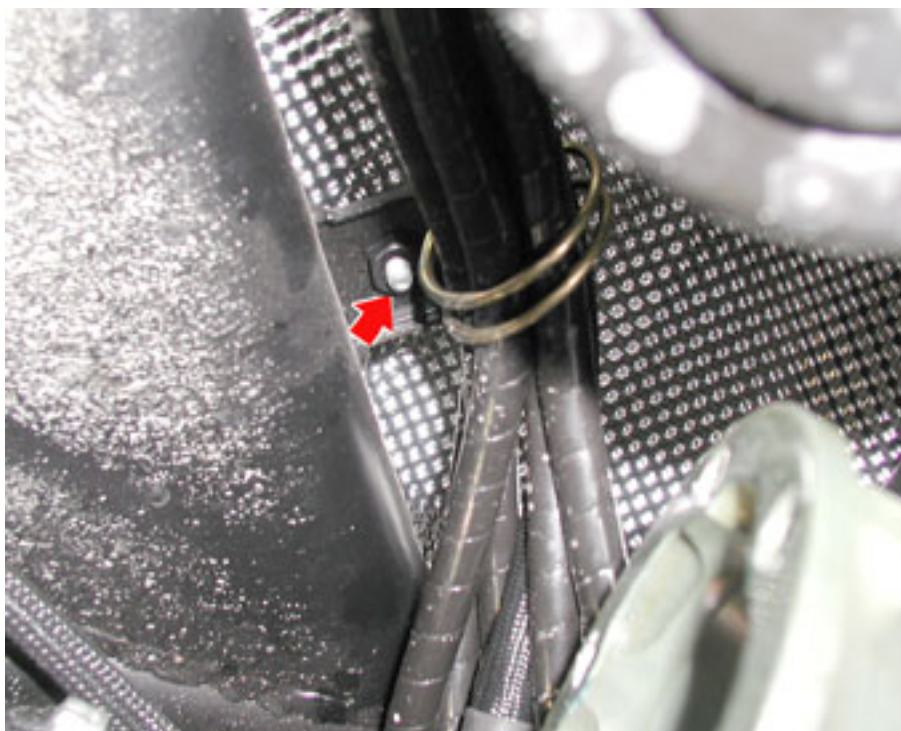

- Disconnect the quick coupling connecting the oil delivery line to the clutch.

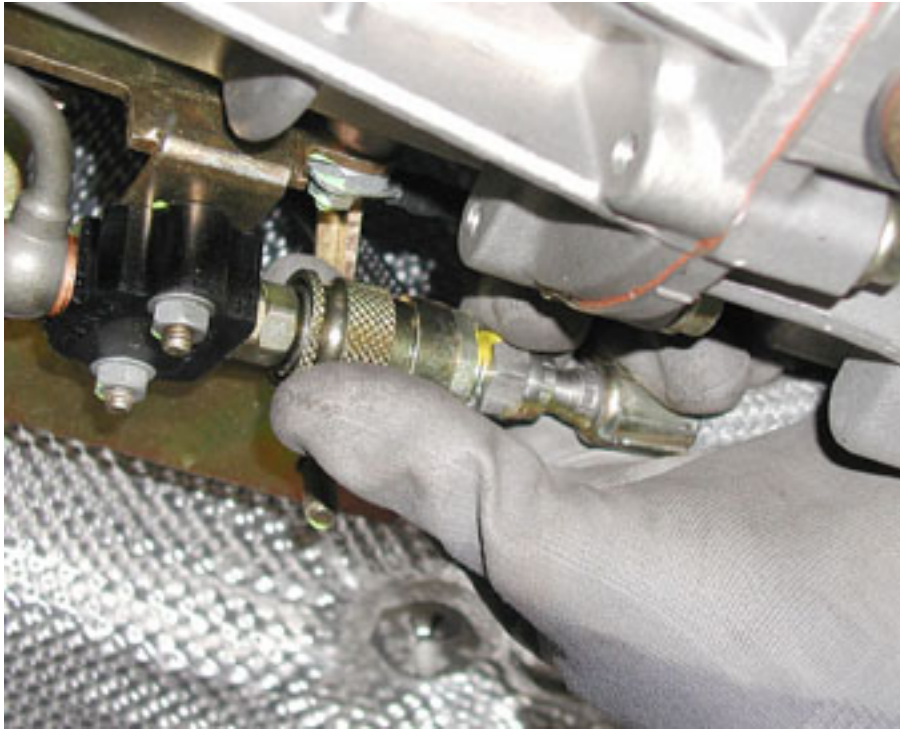

- Unscrew the two fastening nuts and remove the plastic guard fastened to the lower lever.



- Position a hydraulic lifting device under the gearbox supporting cross member, fitted with a suitable tool for the gearbox cross member to rest on.

N.B.

Keep the gearbox aligned with the rear transmission by fitting suitable shims under the gearbox housing.



- Undo the fastening screws on the gearbox supporting cross member.

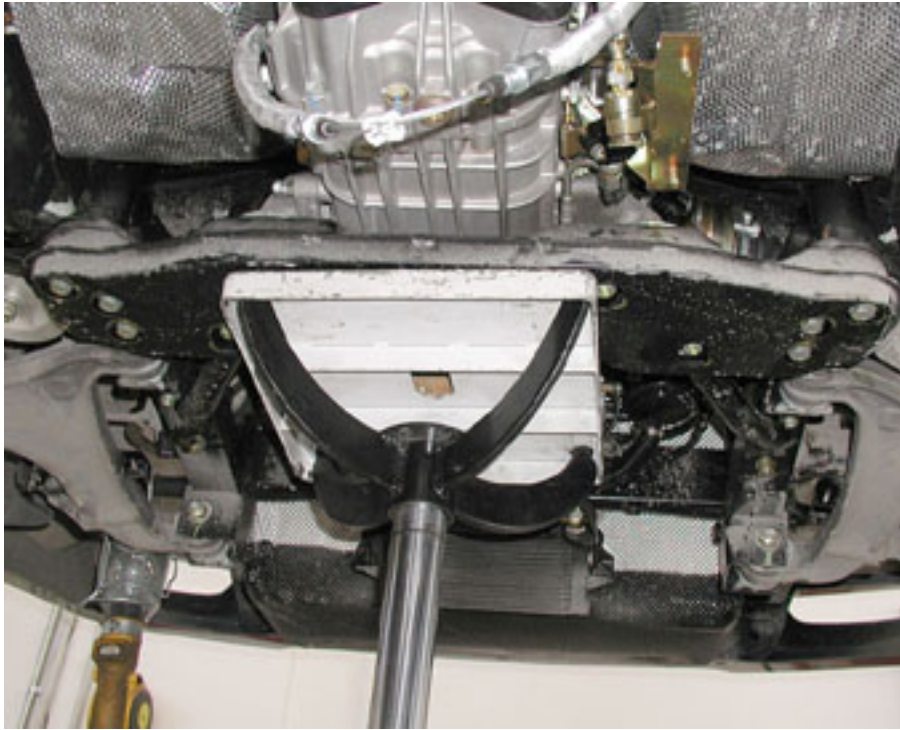

- Lower the gearbox unit until the left-hand handbrake cable can be accessed and released from the fastening bracket.

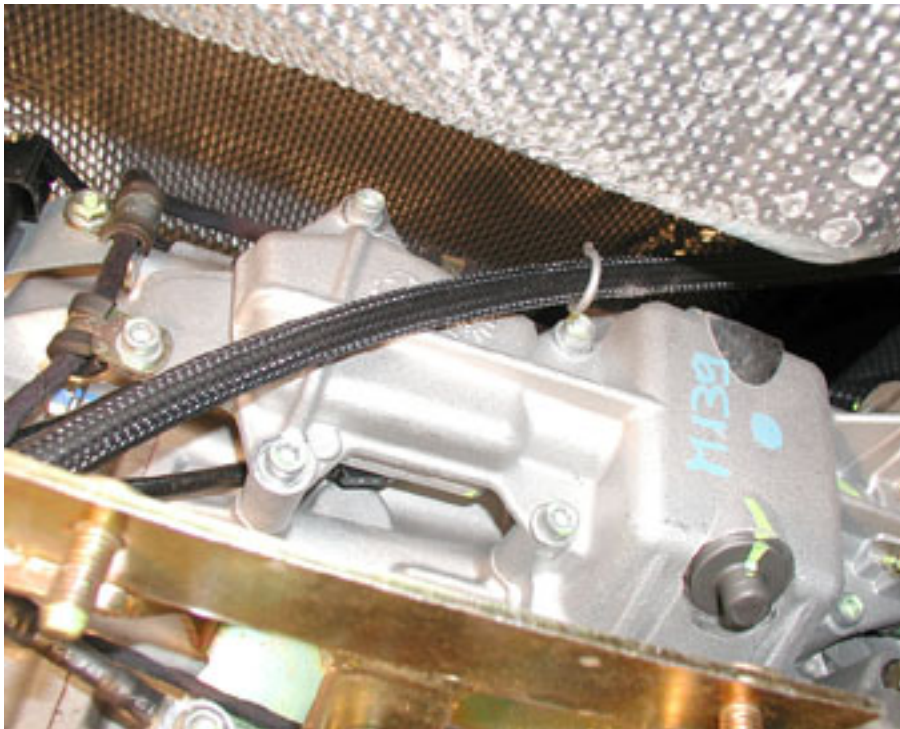

- Unscrew the fastening nut and release the right-hand handbrake cable from the gearbox.

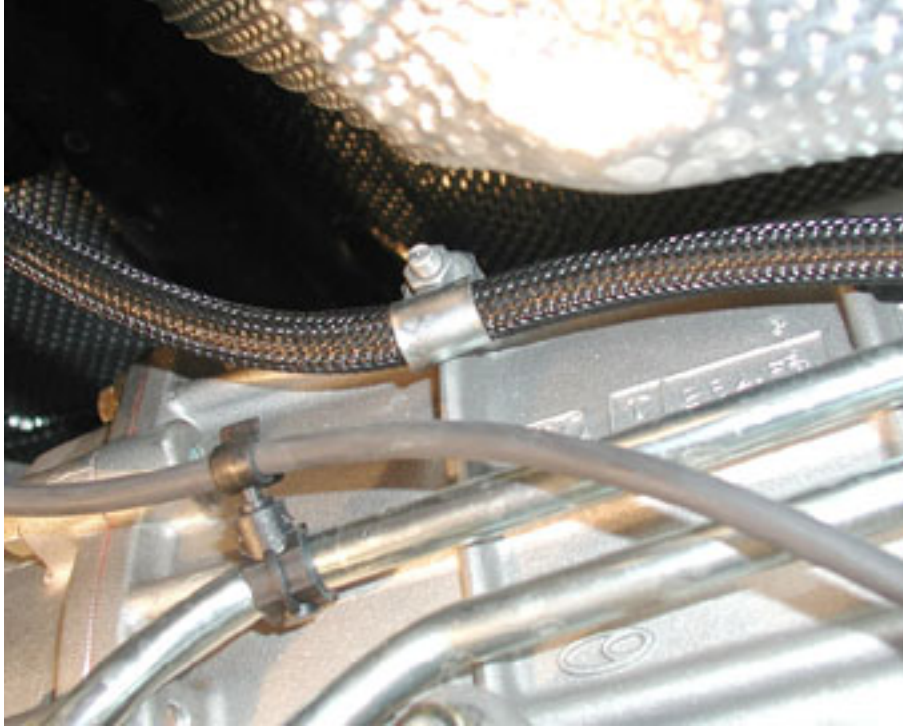

- Place a hydraulic device in position to support the transmission shaft.



- Unscrew the nuts fastening the transmission shaft to the gearbox.



- Working from the transmission shaft -gearbox coupling area, separate the gearbox unit from the transmission shaft.

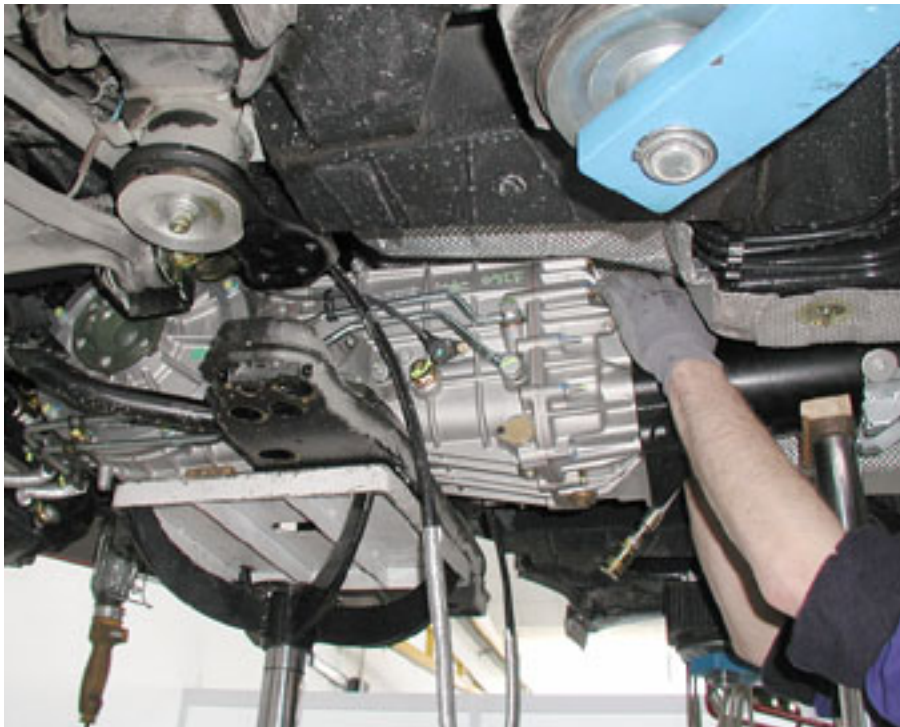

- Slowly lower the hydraulic device and remove the gearbox from its seat on the vehicle.

N.B.

During the gearbox removal operation, take care to ensure the oil radiator is not damaged.



- Unscrew the nuts fastening the two gearbox mounts to the relative rubber bushings and separate the gearbox from the lower cross member.



Refitting the gearbox

- With the gearbox on the bench, check the level of the oil in the tank, then visually inspect that the components are intact and the main fastenings are tightened to the correct torque.
- Position the gearbox on the supporting cross member and tighten the nuts fastening the rubber bushings to the gearbox mounts to a torque of **130 Nm**.



- Position the gearbox and cross member assembly on the hydraulic lifting device complete with the tool to support the gearbox, then fit the gearbox in the relative compartment on the vehicle.
- Connect the gearbox to the transmission shaft and tighten the fastening nuts to a torque of **70 Nm**.



- Tighten the nut fastening the right-hand handbrake cable to the gearbox.
- Fasten the handbrake cable in the relative seat on the left-hand side of the gearbox.
- Position a hydraulic lifting device under the gearbox supporting cross member, fitted with a suitable tool for the gearbox cross member to rest on.

N.B.

Keep the gearbox aligned with the rear transmission by fitting suitable shims under the gearbox housing.



- Lift the gearbox and position it in its seat, then tighten the fastening screws on the gearbox supporting cross member to torque.



- Remove the hydraulic lifting device fitted with the tool used for removing and refitting the gearbox.
- Fit the plastic guard fastened to the lower lever and tighten the two fastening nuts.
- Connect the oil delivery line to the clutch with the quick coupling.
- Tighten the fastening screw on the electronically-controlled gearbox oil line bracket.
- Tighten the screws fastening the right- and left-hand axle shafts to the gearbox to a torque of **80Nm**.

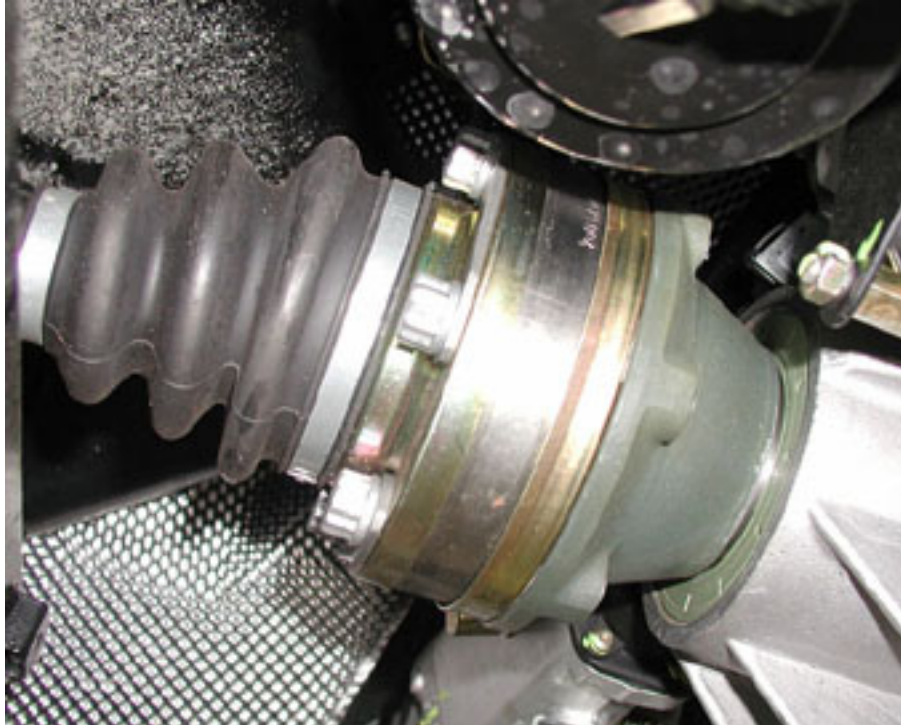

- Fit the bodywork reinforcement bracket located between the transmission shaft and the central silencers and tighten the fastening screws to torque.
- Fit the bodywork reinforcement bracket located under the central exhaust silencers.

- Fit the handbrake cables in their seat on the mount, then tighten the fastening nut on the retaining bracket.

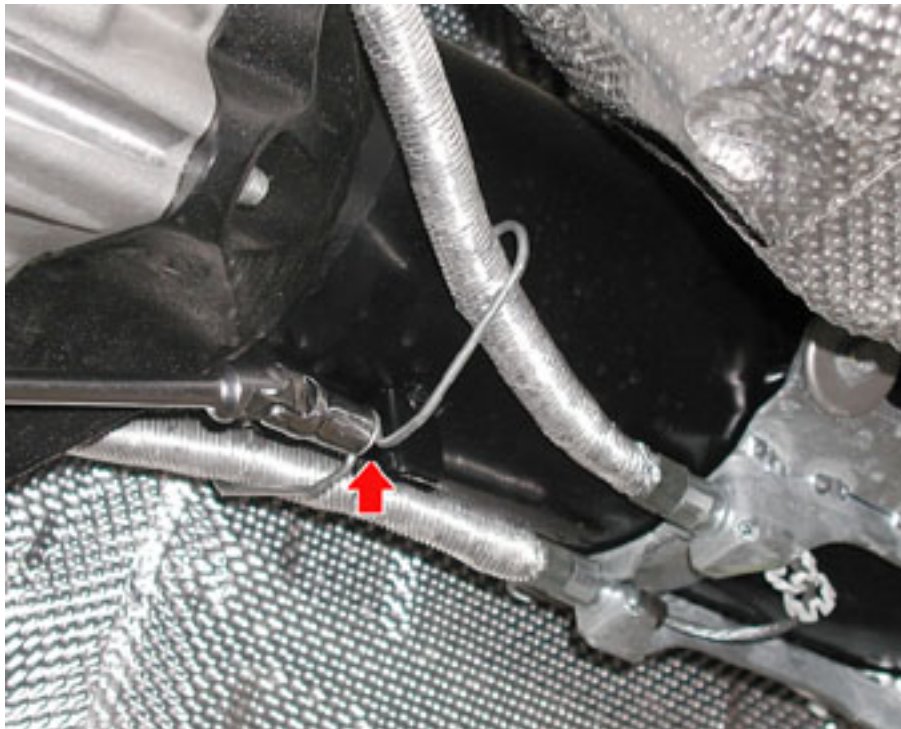

- Fit the plastic clamps retaining the handbrake cables in their seat.

N.B.

When fitting, make sure you do not break the plastic clamps and always check that they are fitted correctly



- Fit the spacer.

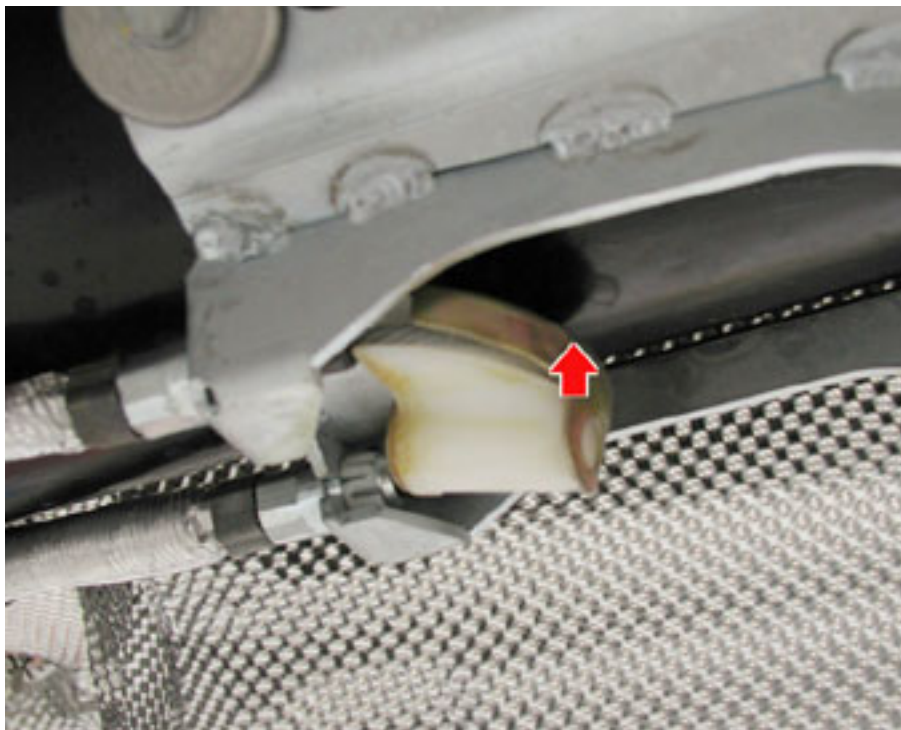

- Position the handbrake cable in its seat connected to the lever, fit the end into the spacer and tighten the nut and check nut.
- Fit the plastic clamp retaining the handbrake cable in its seat.

N.B.

When fitting, make sure you do not break the plastic clamp and always check that it is fitted correctly.

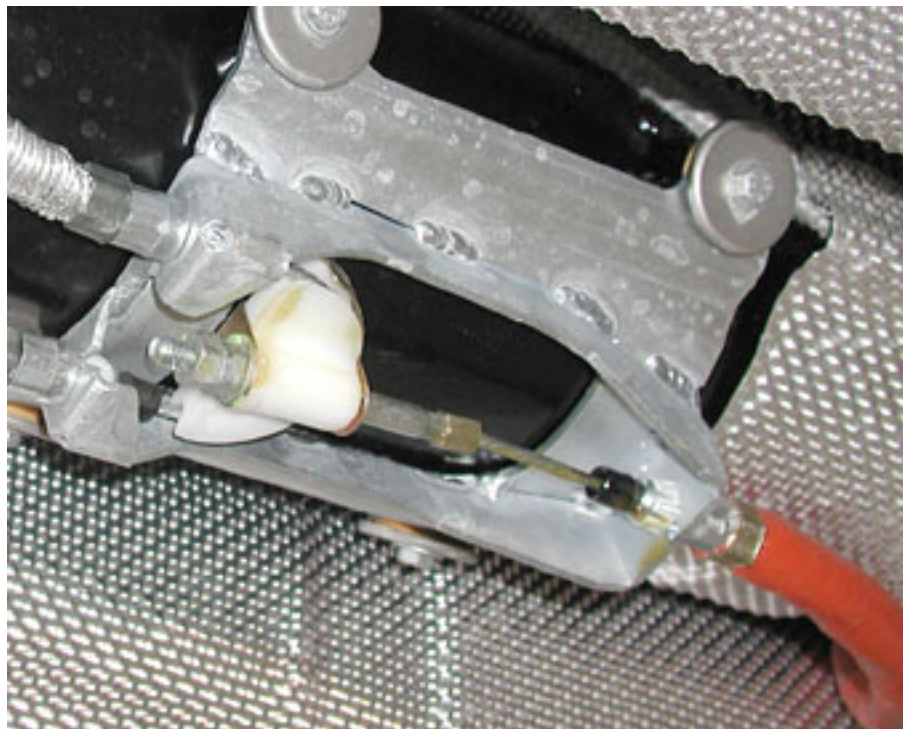

- Fasten the electric connector to the chassis by tightening the fastening screw.



- Attach the three electric connectors.

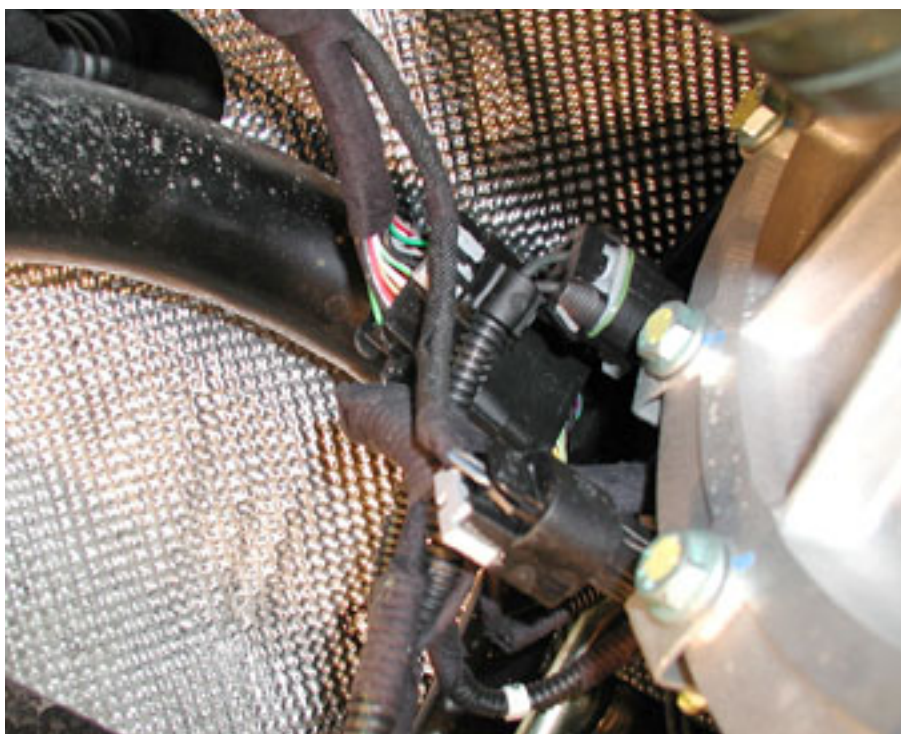

- Fit the exhaust tailpipes on the central silencers and tighten the fastening nuts on the fastening clamps to a torque of **54 Nm**



- Tighten the screws fastening the mounts to the bodywork to a torque of **24 Nm**.



- Fit the right- and left-hand heat guards.

- Fit the exhaust tailpipes.

Removing-refitting the tailpipe

- Carry out the handbrake adjustment operation.

Handbrake cable adjustment

- Remove the vehicle from the hoist.
- Connect the battery's negative terminal.
- After connecting the battery's negative terminal, the following self-learning operations must be carried out to ensure that certain connected devices acknowledge the system again:

Refer to section:

Component self-learning in the event of battery disconnection

- Using the SD3 diagnostics tester, run the self-learning procedure of the gear grid:

REPLACING THE ELECTRONICALLY-CONTROLLED GEARBOX CONTROL UNIT (TCU)

Removing-refitting the electronically-controlled gearbox control unit (TCU)

- Remove the right-hand internal flap.



- Disconnect the battery's negative terminal.
- Unscrew the two nuts fastening the ECU retaining bracket then, holding the ECU, detach the two electrical connections.



When refitting, follow the above procedures in reverse order

- After connecting the battery's negative terminal the following self-learning operations must be carried out to ensure that certain connected devices acknowledge the system again:
- Refer to section:

Component self-learning in the event of battery disconnection

N.B

This operation must only be carried out on versions fitted with the SOFAST 3 gearbox

- If the NCR ECU needs to be replaced, you must carry out the following procedures: the "DEIS Check Parameter self-calibration", the self-learning for the gears and the accelerometer calibration.
- Position the vehicle on an even surface.
- To carry out the DEIS adjustment procedure, you must connect the SD3 diagnosis instrument (**95970312**) to the diagnosis socket on the Body Computer.
- Select the "**ACTIVE DIAGNOSIS**" field.
- Select the "**SINGLE ECU DIAGNOSIS**" button".
- Select the vehicle manufacturer and model.
- Select the ECU concerned (NCR M139 SOFAST3).
- Wait for the data to load and follow the guided procedure.
- Select "**ACTIVE DIAGNOSIS ENVIRONMENT**".
- A menu will appear with the following six different submenus:
 - **UPLOAD/DOWNLOAD**
 - **DEIS check parameter self-calibration**
 - **Self-learning**
 - **Accelerometer offset self-calibration**
 - **1st gear engagement**
 - **2nd gear engagement**
- Select "**DEIS check parameter self-calibration**" and wait for the automatic loading procedure to finish.
- This procedure should take approximately 3 minutes and 30 seconds with a check time of 6 minutes, after which the procedure is considered unsuccessful if not completed.
- If the procedure is completed successfully, continue with the gear grid self-calibration (self-learning).
- If the DEIS adjustment procedure has ended unsuccessfully, identify the causes and carry out the following checks:
 - Check that the clutch bleeding has been carried out correctly.
 - Check that the clutch control solenoid valve is operating properly.
 - Repeat the **DEIS Check Parameter Self-Calibration procedure**
- Continue the gear grid self-calibration by selecting "**self-learning**" then wait for the automatic procedure to finish.
- This procedure should take approximately 1 minutes and 30 seconds with a check time of 2 minutes, after which the procedure is considered unsuccessful if not completed..
- If the procedure is completed successfully, continue with the accelerometer self-calibration.
- Select "**Accelerometer offset self-calibration**" and wait for the automatic procedure to finish.
- This procedure should take approximately 30 seconds with a check time of 40 seconds, after which the procedure is considered unsuccessful if not completed.
- If the procedure has been successfully completed and no further adjustments are required, turn the ignition key to "**OFF**" and wait at least 25 seconds. This is the shortest time required to enable the ECU to store the parameters learnt.

POWER UNIT

Removing-refitting the Power Unit

- Disconnect the connector for the gearbox rpm sensor and for the potentiometer.



- Unscrew the three nuts fastening the electric system and the screw fastening the earths.



- Unscrew the two nuts fastening the clutch control pipe's coupling valve block.



- Undo the screw fastening the mounting bracket for the exhaust tailpipes' bushings and remove it.



- Loosen the nut fastening the upper bracket.



- Undo the screw fastening the lower bracket.

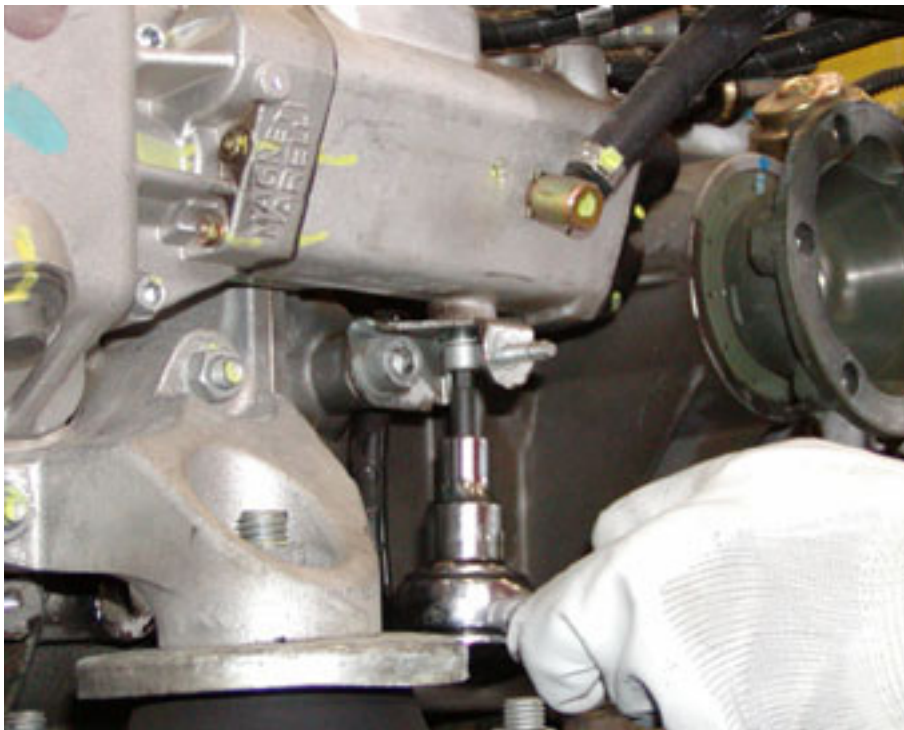

- Undo the upper fastening screw on the power unit mounting bracket, on the left-hand side of the gearbox.

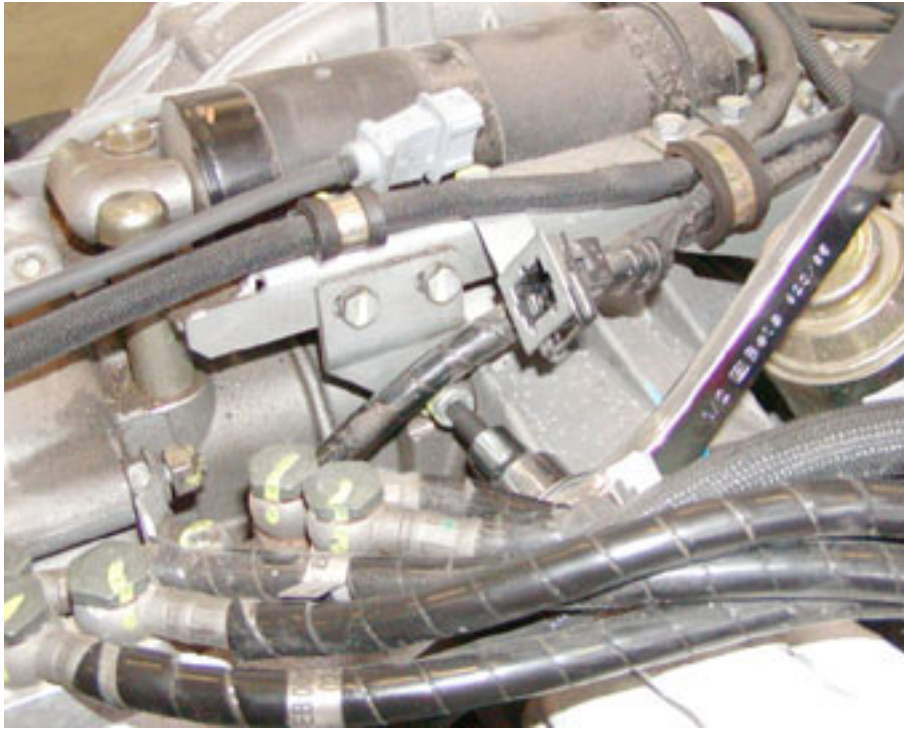

- Undo the lower fastening screw on the power unit support bracket, on the left-hand side of the gearbox.



- Undo the three fastening screws on the power unit mounting bracket, that are located on the rear of the gearbox, and the nut fastening the electric system retaining clamp.

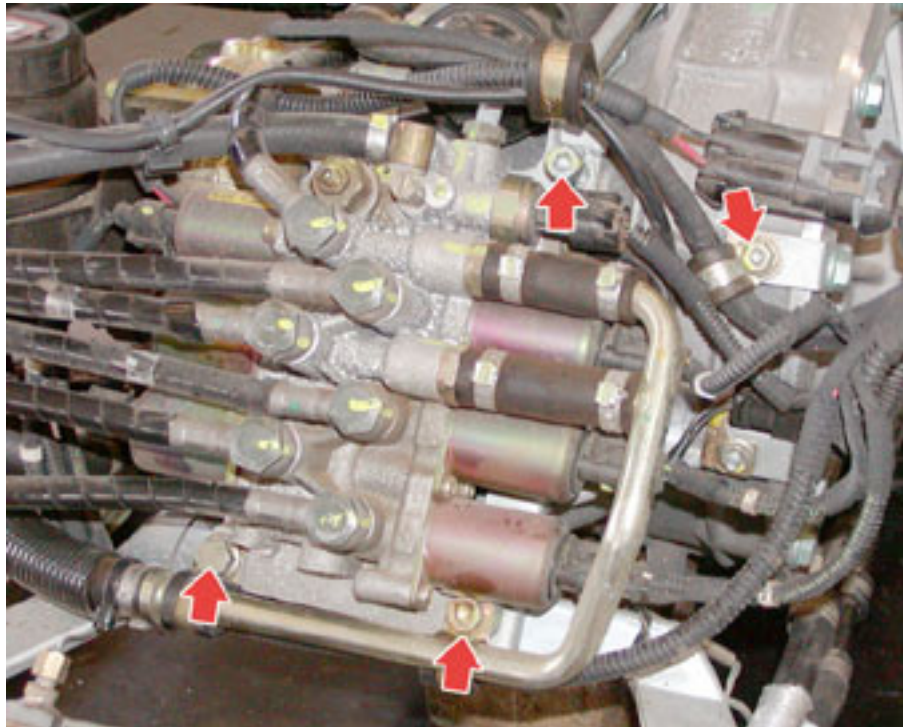

- Undo the fastening screw on the power unit mounting bracket, on the right-hand side of the gearbox.



- Remove the potentiometers connector from the bracket.

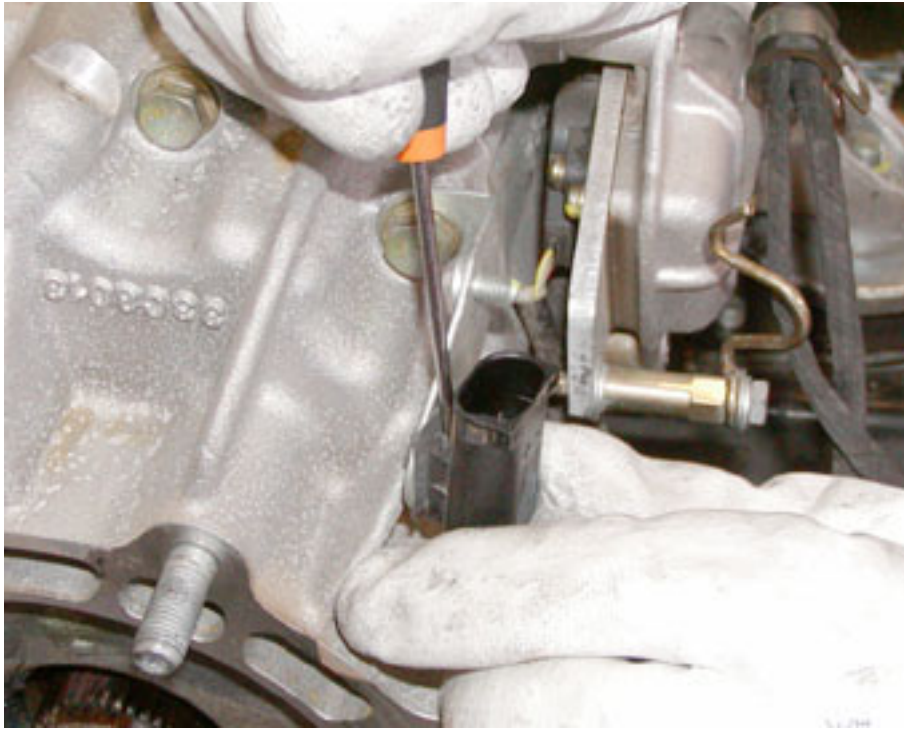

- Unscrew the eight actuator fastenings, then remove the actuator

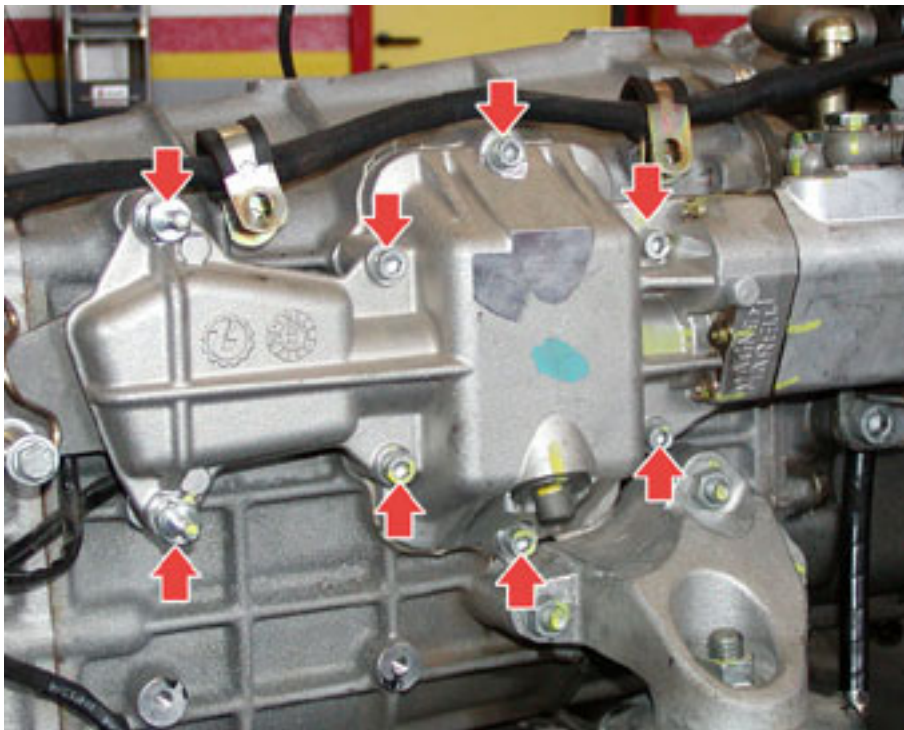

- Clean the contact surface between the actuator and the gearbox housing carefully.



N.B.

During the refitting stage, apply CAF 4 sealant to the area between the gearbox and the actuator.

When refitting, follow the above procedures in reverse order

ESTABLISHING THE ELECTRONICALLY-CONTROLLED GEARBOX OIL TANK LEVEL

N.B.

The following procedure shows how to establish the electronically-controlled gearbox's oil tank level in the vehicle.

- Working from the rear of the vehicle, unscrew the cap



- Using a syringe, top up the oil in the electronically-controlled gearbox oil tank.

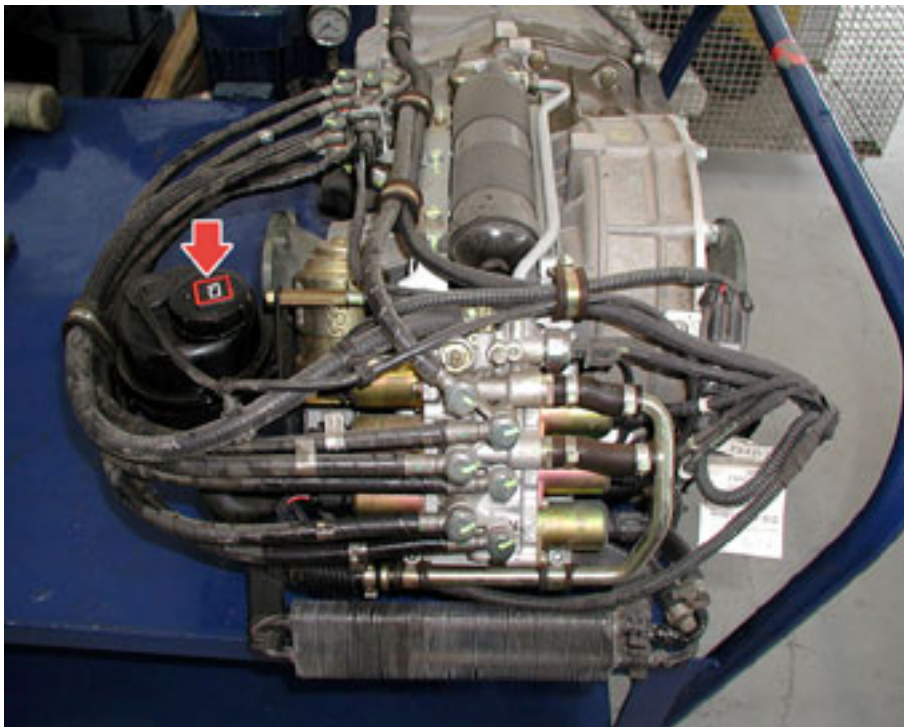

- Set the key in the "key on" position on the panel.
- Make sure the motor-driven pump has charged the electronically-controlled gearbox system.
- Drain out the oil from the tank using the specific tool **900027330**, making sure the remaining oil level is between the **MIN** and **MAX** notches on the tool.

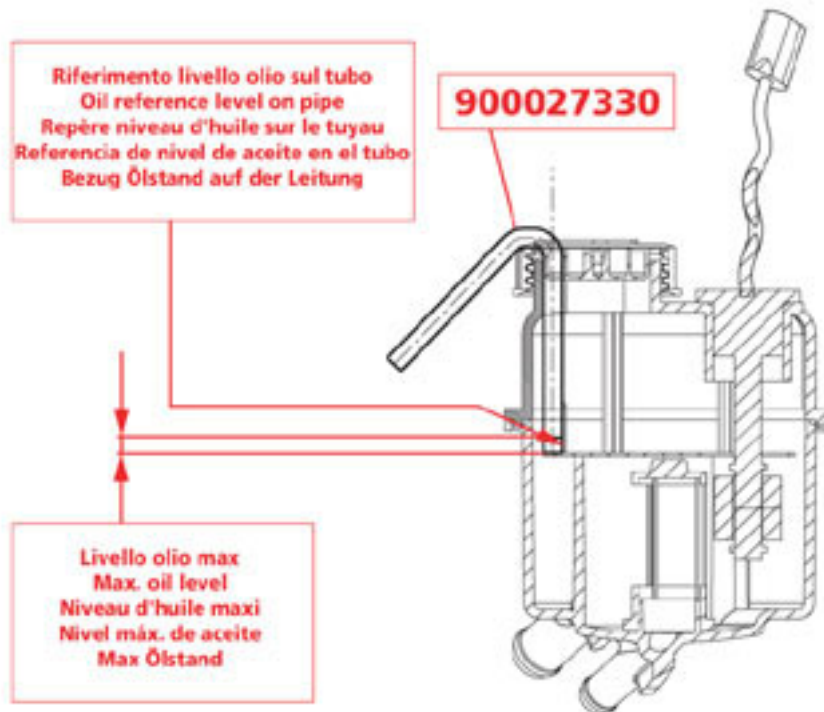

KISS POINT (PIS) AJDUSTMENT PROCEDURE

- Proceed by adjusting the KISS POINT (PIS).
- Lift the suspension control node guard.



- Access the 4-way connector for the C-CAN line located in the suspension control node compartment and detach it.



- Plug the SD3 (95970312) into the EOBD diagnosis connector (1).
- Attach the C-CAN connector (2a) to the SD3 cable bundle (95979568) (2b).
- Attach the C-CAN connector (2c) to the SD3 cable bundle (95979568) (2d).

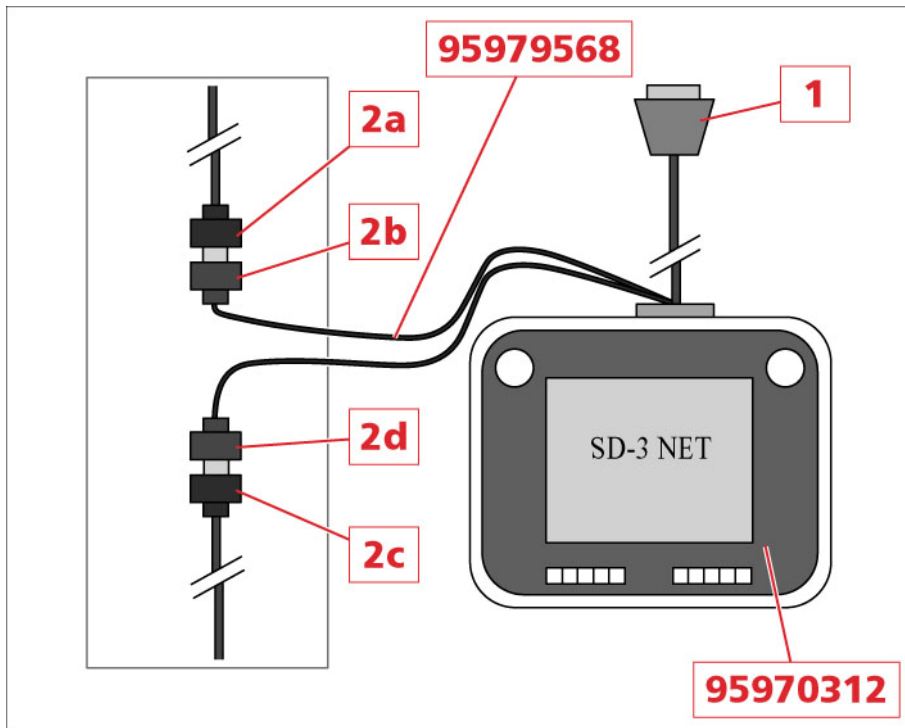

CAUTION

For the KISS-POINT value to be reliable and useful for clutch testing, this should be measured in the normal clutch operating conditions ([80,100]°C). To allow the clutch to reach these temperature conditions, i.e. a stabilised and uniform thermal state, you must perform the following manoeuvres on the road:

- Warm up the engine by driving normally (without using the clutch) for 5 minutes.
- Perform 4 pick-up manoeuvres by fully depressing the pedal. The pick-up manoeuvre is complete when synchronisation between the engine and the input shaft has been reached (the clutch will be completely closed at about 5000 rpm).
- Wait a few seconds between one pick-up and the other.
- Wait for the clutch to reach its operating temperature by driving normally for 5 minutes (ideally at 4000 rpm), avoiding further pick-ups or gearshifts as far as possible. In case of frequent pick-up manoeuvres, extend the cooling time (15 min.).

- Switch on the SD3 and select the " **NCR KISS-POINT** " software option from the diagnosis programmes.
- Select the " **KISS POINT ENVIRONMENT**" function
- The user is guided through the subsequent stages by the diagnosis system chosen.
- Enter the vehicle serial number.
- Use the TAB button to select "**CONTINUE**" then press "**ENTER**" to confirm the data entered.
- The system will display a warning message for the user, advising him/her of the vehicle conditions required to run the calibration procedure correctly.

N.B.

If a high clutch temperature is signalled, let the clutch cool down even further, possibly while driving or in N, letting the engine run.

- If the vehicle meets the conditions which permit the procedure to continue, press "ENTER".
- Shift the gear to neutral, rotate the ignition switch to the OFF position, wait approximately 15 seconds, then start the engine and select "ENTER" on the SD3.
- Select "**START PROCEDURE** "
- The following screen pages instruct the user to keep the accelerator pedal pressed throughout the entire data acquisition period.
- The system will carry out 10 clutch opening and closing cycles automatically, with the gearbox in the neutral position, during which the SD3 will acquire the data needed to calculate the touch point (PIS) correctly.
- Wait for the data acquisition procedure end message to appear on the display and a tone to be emitted by the instrument panel node.

- The SD3 will display the "TRANSMITTABILITY" graph, i.e. the current touch point (PIS) position (in red) and the two references curves (in black) indicating the tolerance range within which the touch point curve must be located.

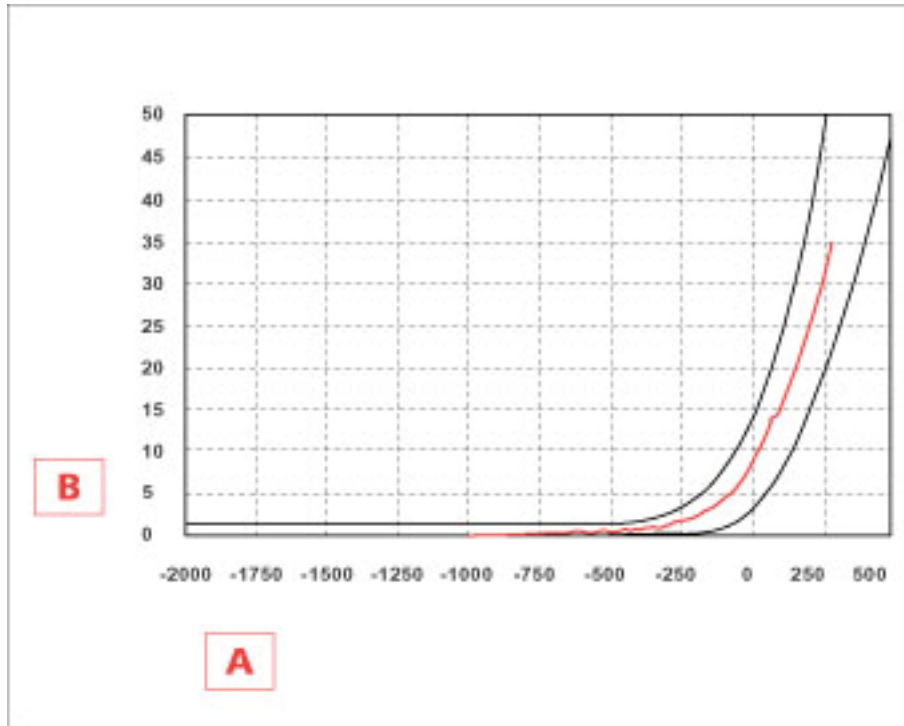

A = CSC bearing movement (Thousandths)
B = Torque (Nm)

- The system will automatically check that the touch point (PIS) curve read lies within the two tolerance curves.
- Two results are possible, depending on the outcome of this processing:
 - the data are correct and therefore the system will proceed with the next data acquisition stages.
 - the data are incorrect and therefore the procedure will be cancelled and an error message will be displayed with instructions for problem solving.
- At the end of each data acquisition and processing sequence, the following parameters will be displayed:

Number of pick-ups	(1-3, 2-3, 3-3)
Touch point (PIS) value (bit,mm)	(Min 6.00 120 bit, MAX 160 bit)
POINT SCATTERING value	(Min 0 bit, MAX 10 bit)

- If completed correctly, the procedure will be performed a further two times.
- On completion of the three stages, the average touch point (PIS) value will be calculated and memorised by the gearbox ECU.
- The message "**TOUCH POINT (PIS) WRITTEN CORRECTLY**" will appear on the SD3 display.

PIS (KISS POINT) values in millimetres:

EUROPE Sofast 2 :	min 4.8 max 5.4 Base 5.1
USA/CND Sofast 3	min 4.2 max 4.4 Base 3.93
EUROPE Sofast 3	min 4.2 max 4.4 Base 3.93

CHECKING AND TOPPING-UP THE OIL LEVEL IN THE GEARBOX HOUSING

Checking and topping-up the oil level in the gearbox housing

- Place the vehicle on the hoist.
- Unscrew the fastening nuts on the exhaust tailpipe mount, then unscrew the three fastening nuts on the bracket and remove it.



- Unscrew the cap.
- Check that the oil level is skimming the lower edge of the filling hole.

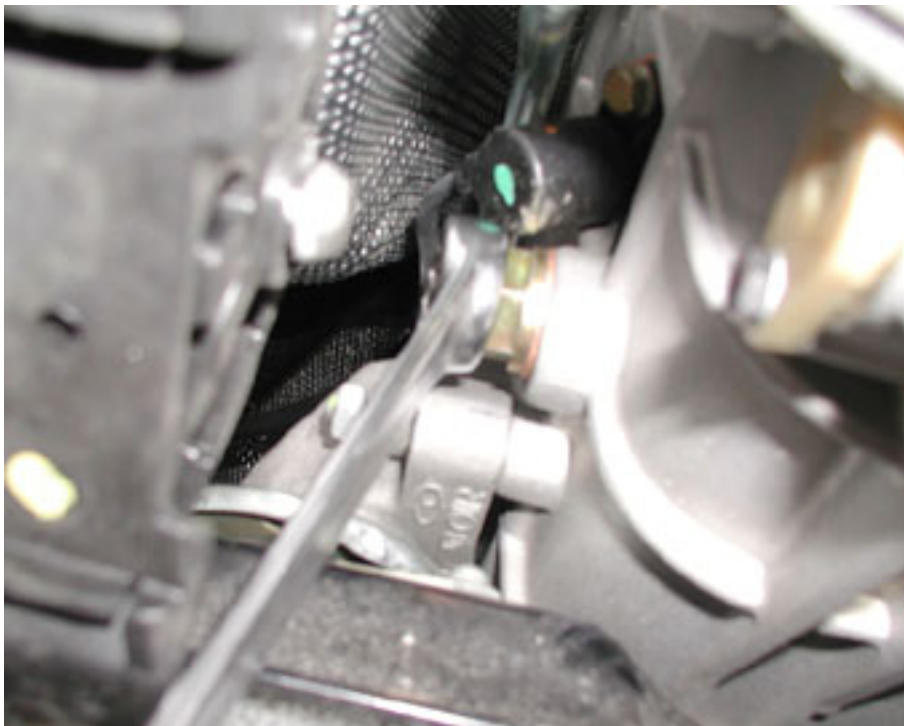

- If the oil level is below the hole, top it up using suitable equipment, until it reaches the lower edge of the filling hole.



- Once topped up, clean the filling hole and replace the sealing gasket.
- Tighten the filling cap.
- Fit the bracket and screw up the fastening nuts.
- Tighten the nuts fastening the mount to the bodywork to a torque of **24 Nm**.



- Remove the vehicle from the hoist.

If the gearbox oil needs to be changed, the oil draining cap shown in the figure must be unscrewed.

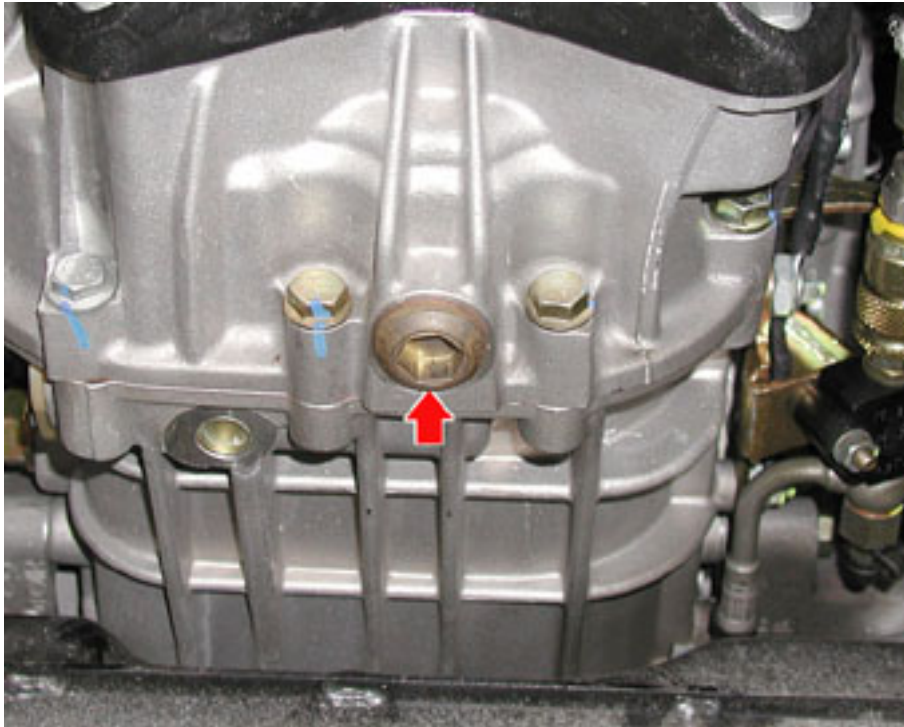

GEARBOX OIL COOLING RADIATOR

Removing the gearbox oil cooling radiator

N.B

Component not present on US versions and fitted on the other versions until the end of 2004

- Place the vehicle on the hoist.
- Unscrew the two unions on the two oil delivery and return lines.
- Place a suitable pan beneath the lines to salvage the oil and plug the two lines as required.

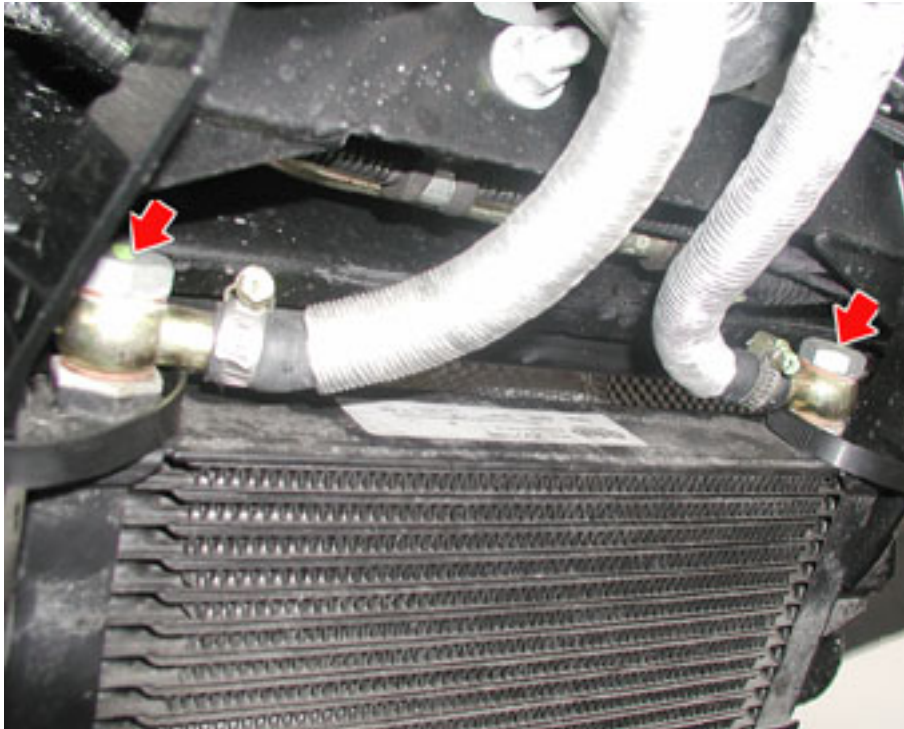

- Unscrew the two nuts fastening the oil radiator to the mounting bracket and remove it.



Refitting the gearbox oil cooling radiator

- Fit the oil radiator in its seat on the bracket and tighten the two fastening nuts.
- Connect the two delivery and return lines and tighten the two unions to a torque of **34 Nm**.

IMPORTANT

The gaskets on the two oil line fastening unions must always be replaced.

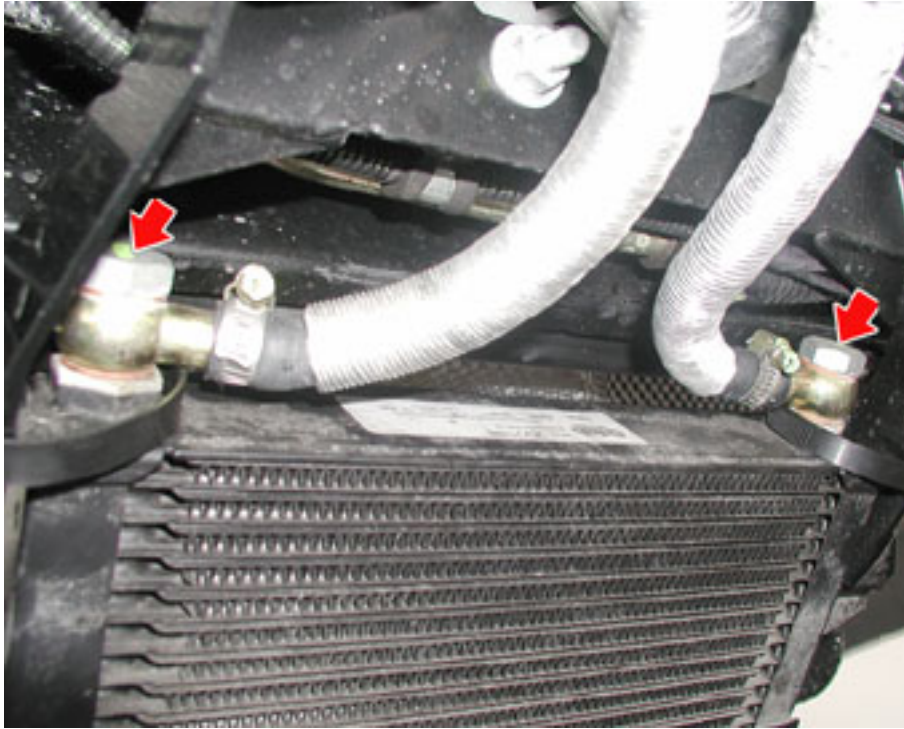

- Proceed by topping up the level of the oil in the gearbox.

Checking and topping-up the oil level in the gearbox housing

- Remove the vehicle from the hoist.

CLUTCH PRESSURE SENSOR

Removing – refitting the clutch pressure sensor

N.B

Component included on the SOFAST 3 gearbox versions only

- Place the vehicle on the hoist.
- Remove the RH catalytic converter.

Catalytic converters

- Disconnect the electrical connector **(1)**, using the specific tool, then unscrew and remove the clutch pressure sensor **(2)**.

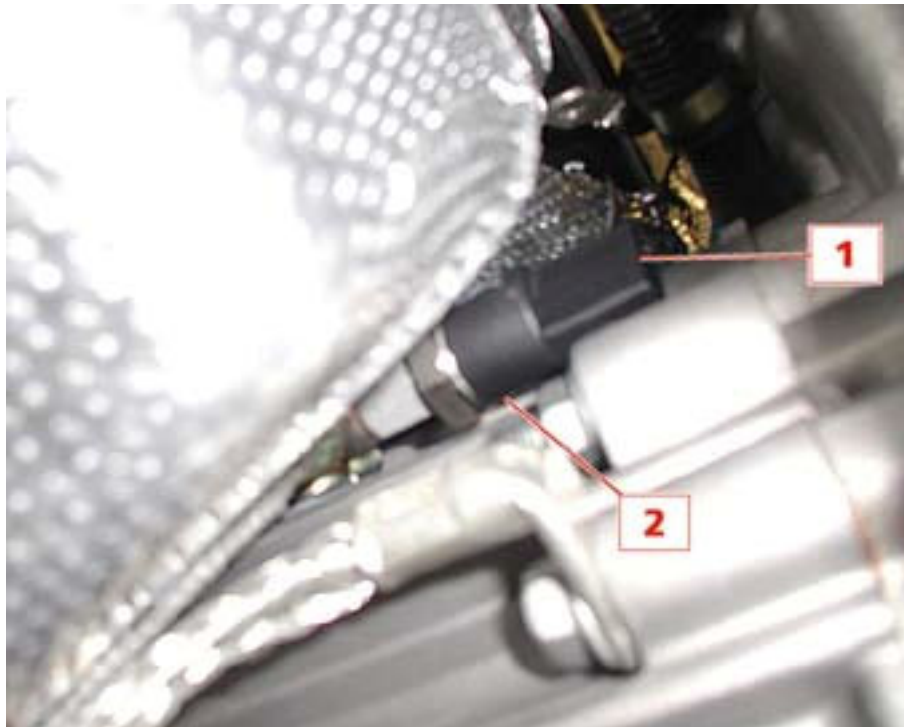

When refitting, follow the above procedures in reverse order.

- When the component has been fitted, bleed the hydraulic clutch system.

Bleeding the clutch

DEIS ADJUSTMENT PROCEDURE

- Following the replacement of the clutch unit or the robotised gearbox unit (NCR), the DEIS procedure, which consists in the self-calibration of the clutch spring, must be carried out.
- To carry out the DEIS adjustment procedure, you must connect the SD3 diagnosis instrument (**95970312**) to the diagnosis socket on the Body Computer.
- Select the “**ACTIVE DIAGNOSIS**” field.
- Select the “**SINGLE ECU Diagnosis**” button”.
- Select the vehicle manufacturer and model.
- Select the ECU concerned (NCR M139 SOFAST3).
- Wait for the data to load and follow the guided procedure.
- Select “**ACTIVE DIAGNOSIS ENVIRONMENT**”.
- A menu will appear with the following six different submenus:
 - **UPLOAD/DOWNLOAD**
 - **DEIS check parameter self-calibration**
 - **Self-learning**
 - **Accelerometer offset self-calibration**
 - **st gear engagement 1**
 - **st gear engagement 2**
- Select “**DEIS Check Parameter Self-Calibration**” then wait for the automatic procedure to finish.
- This procedure should take approximately 3 minutes and 30 seconds with a check time of 6 minutes, after which the procedure is considered unsuccessful if not completed.
- If the procedure has been successfully completed and no further adjustments are required, turn the ignition key to “**OFF**” and wait at least 25 seconds. This is the shortest time required to enable the ECU to store the parameters learnt.
- If the DEIS adjustment procedure has ended unsuccessfully, identify the causes and carry out the following checks:
 - Check that the clutch bleeding has been carried out correctly
 - Check that the clutch control solenoid valve is operating properly.
 - Repeat the **DEIS Check Parameter Self-Calibration procedure**

ACCELEROMETER SELF-CALIBRATION PROCEDURE

- The replacement or removal-refitting of the accelerometer or the replacement of the robotised gearbox (NCR) ECU must be followed by the accelerometer self-calibration procedure.
- Position the vehicle on an even surface.
- To carry out the DEIS adjustment procedure, you must connect the SD3 diagnosis instrument (**95970312**) to the diagnosis socket on the Body Computer.
- Select the “**ACTIVE DIAGNOSIS**” field.
- Select the “**SINGLE ECU Diagnosis**” button”.
- Select the vehicle manufacturer and model.
- Select the ECU concerned (NCR M139 SOFAST3).
- Wait for the data to load and follow the guided procedure.
- Select “**ACTIVE DIAGNOSIS ENVIRONMENT**”.
- A menu will appear with the following six different submenus:
 - **UPLOAD/DOWNLOAD**
 - **DEIS check parameter self-calibration**
 - **Self-learning**
 - **Accelerometer offset self-calibration**
 - **st gear engagement 1**
 - **st gear engagement 2**
- Select “**Accelerometer offset self-calibration**” then wait for the automatic procedure to finish.
- This procedure should take approximately 30 seconds with a check time of 40 seconds, after which the procedure is considered unsuccessful if not completed.
- If the procedure has been successfully completed and no further adjustments are required, turn the ignition key to “**OFF**” and wait at least 25 seconds. This is the shortest time required to enable the ECU to store the parameters learnt.

ACCELERATION SENSOR

Removing–refitting the acceleration sensor

- Component specific to the electronically-controlled gearbox with Sofast 3 type management
- Remove the central tunnel

Central tunnel

- Detach the electrical connection (1), unscrew the fastening nuts (2) and remove the acceleration sensor (3).

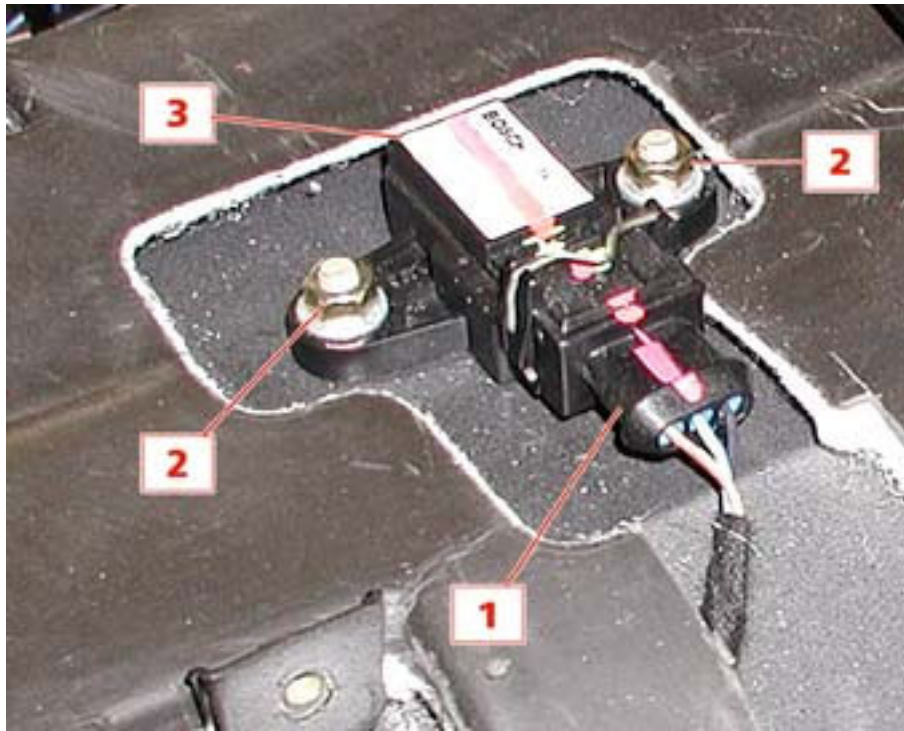

When refitting, follow the above procedures in reverse order.

- Once the component fitting stage is complete, perform the sensor self-calibration procedure using the SD3, whether the component has been replaced or removed and refitted.

Accelerometer self-calibration procedure

AXLE SHAFTS

Removing the axle shafts

- Remove the wheel concerned.

Replacing the wheels

- Remove the rear shock absorber concerned

Rear shock absorbers

- Unscrew the nut fastening the stabiliser bar connecting rod, on the right- and left-hand side of the vehicle.



- Undo the nuts fastening the stabiliser bar to the chassis.

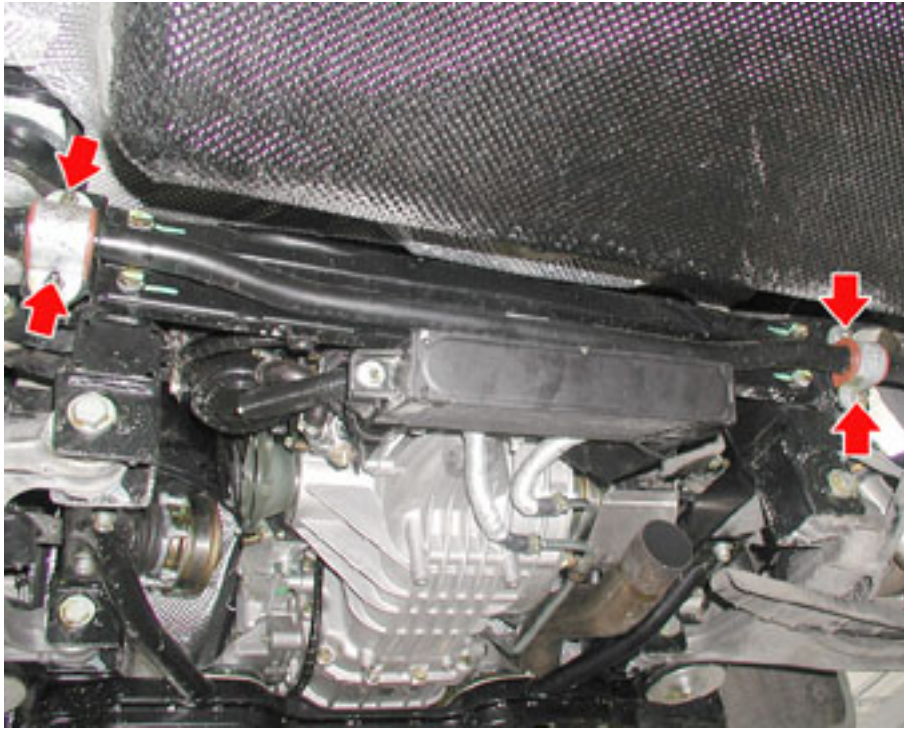

- Remove the stabiliser bar.



- Remove the flattened part from the nut fastening the wheel hub to the axle shaft and loosen the said nut.

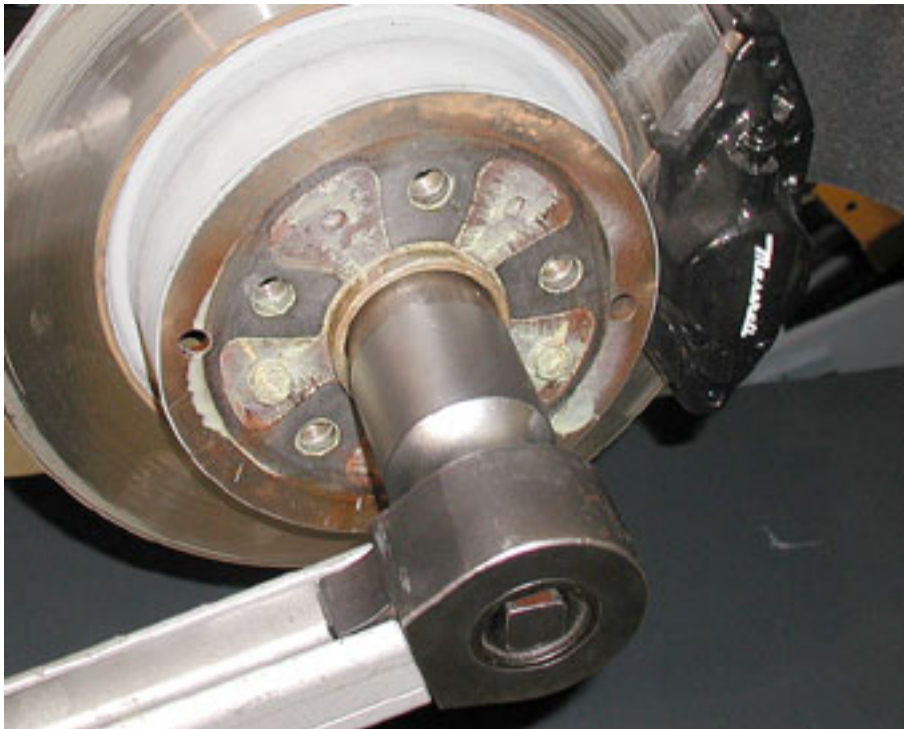

- Remove the relative rear wheel brake disc.

Rear brake disc

- Position the specific tool to remove the axle shaft from the hub carrier.
- Screw it onto the threaded pin of the tool and proceed with removal of the axle shaft.



- Undo the nut fastening the upper lever to the hub carrier.



- Using the extracting tool shown, draw the lever's tapered pin out the hub carrier.



- Unscrew the nut and, using an extracting tool, separate the tapered head of the toe-in tie-rod from the hub carrier.



- Undo the screws that secure the constant speed universal joint to the flange, then remove the axle shaft from the vehicle.



Refitting the axle shafts

IMPORTANT

The components of the rear suspension must be tightened with the vehicle under static load, i.e.: all fluids up to top level (including fuel) plus 75+75 kg on the front seats.

- Check that the rubber boots are intact.
- Also check that there is no grease leakage.
- Position the axle shaft on the hub carrier and in the flange on the gearbox and tighten the retaining screws on the flange to a torque of **80 Nm**.



- Connect the toe-in tie-rod to the hub carrier and tighten the fastening nut to a torque of **80 Nm**.

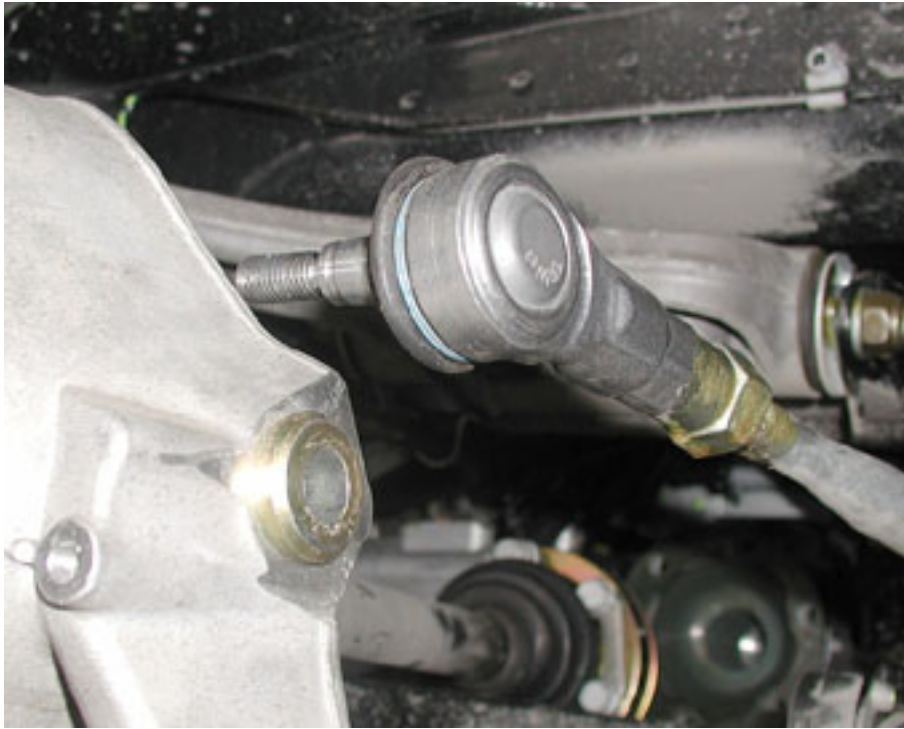

- Tighten the nut fastening the lever to the pillar (hub carrier) to a torque of **52 Nm**.



- Complete the procedure by carrying out all the refitting operations for the rear brake disc concerned.
Rear brake disc
- Tighten the nut fastening the wheel hub to the axle shaft to a torque of **275 Nm**

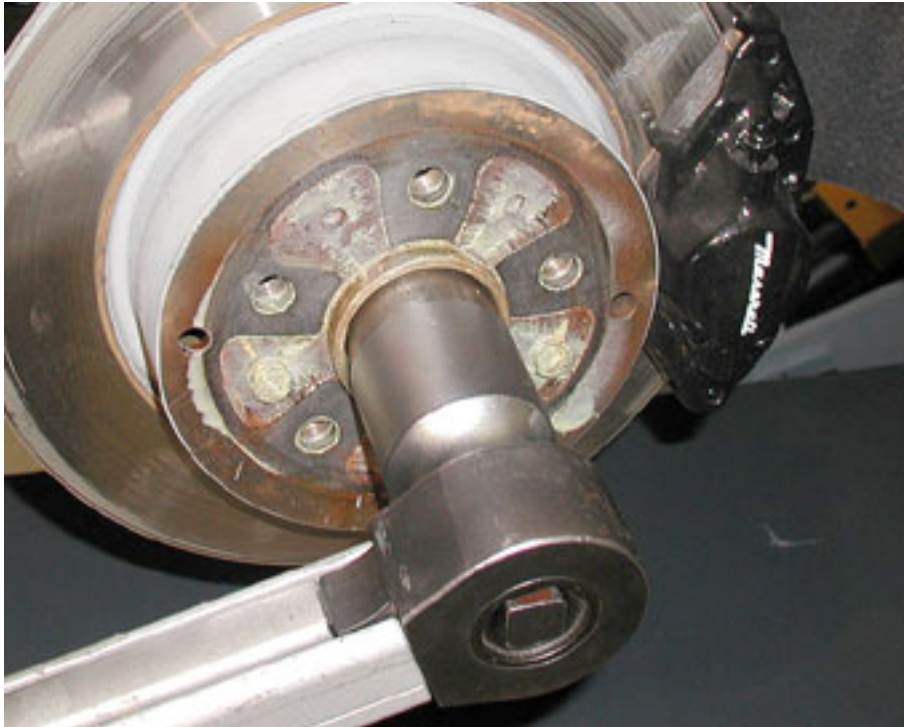

- Flatten the fastening nut.

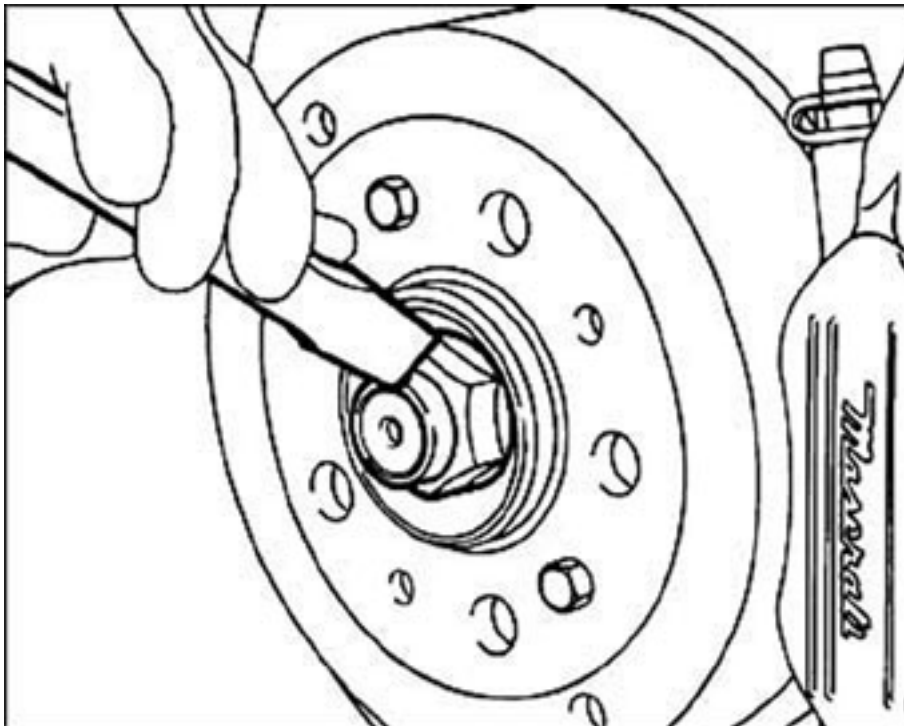

- Fit the stabiliser bar and tighten the fastening nuts to a torque of **31 Nm**.

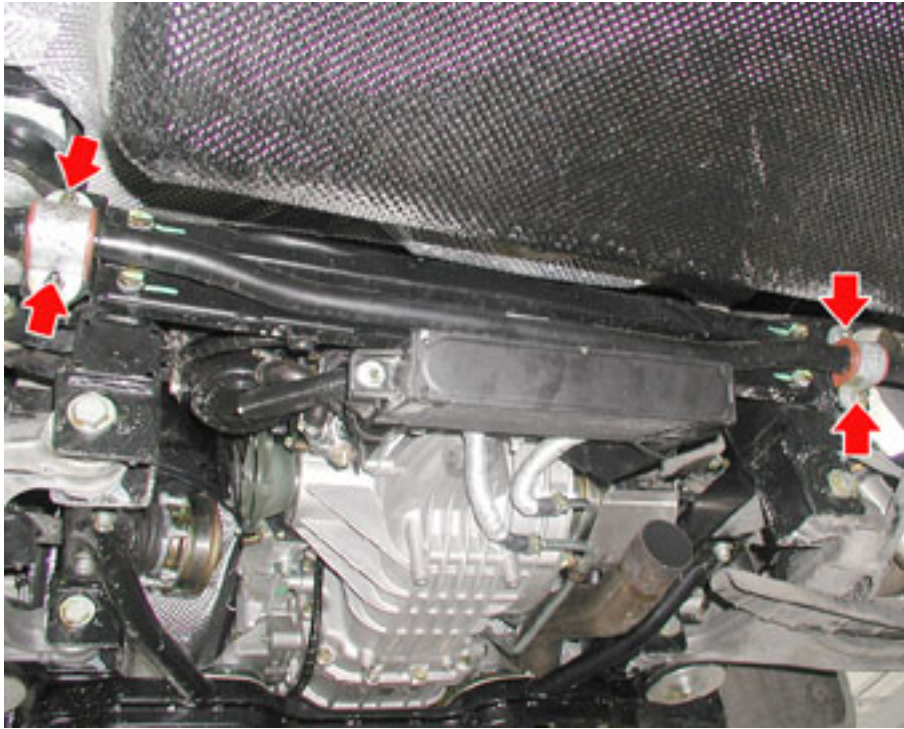

- Tighten the nuts fastening the small connecting rods to the stabiliser bar to a torque of **50 Nm**.

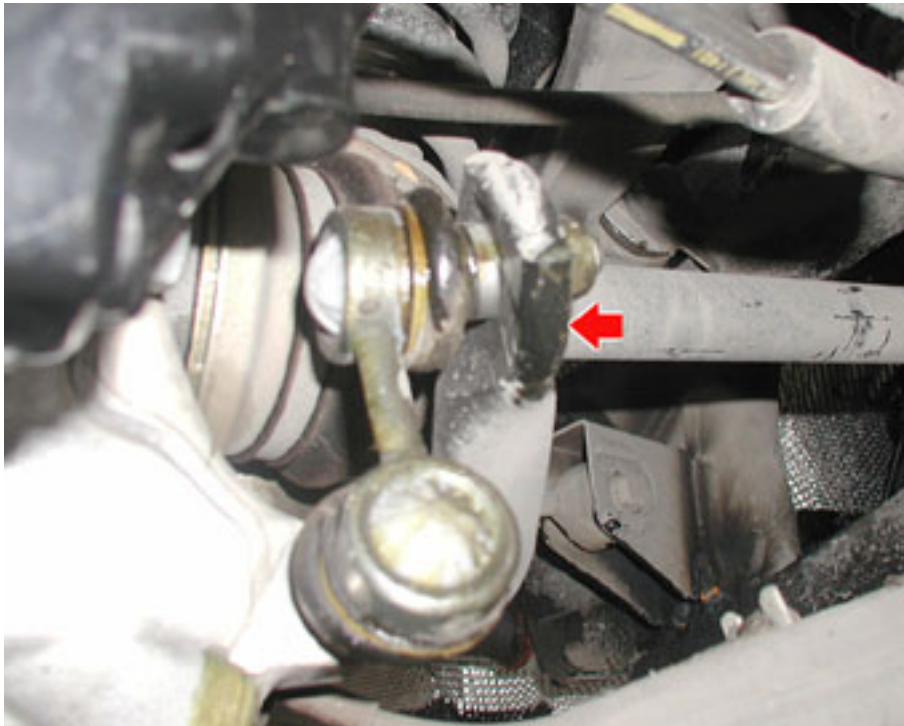

- Fit the rear shock absorber removed.

Rear shock absorbers

- Complete the procedure by carrying out all the refitting operations for the wheel concerned.

Replacing the wheels

N.B.

We recommend you check the wheel alignment data by carrying out the operations outlined in the specific chapter

Wheel alignment - Front wheels

Wheel alignment - Rear wheels

REMOVING-REFITTING THE TRANSMISSION SHAFT

Removing the transmission shaft

- Remove the exhaust tailpipes.
Removing-refitting the tailpipe
- Remove the gearbox.
Removing-refitting the gearbox

ALL VERSIONS EXCEPT USA- CANADA

- Unscrew the two rear Lambda sensors on the catalytic converters and release the cables from the central fastening bracket.

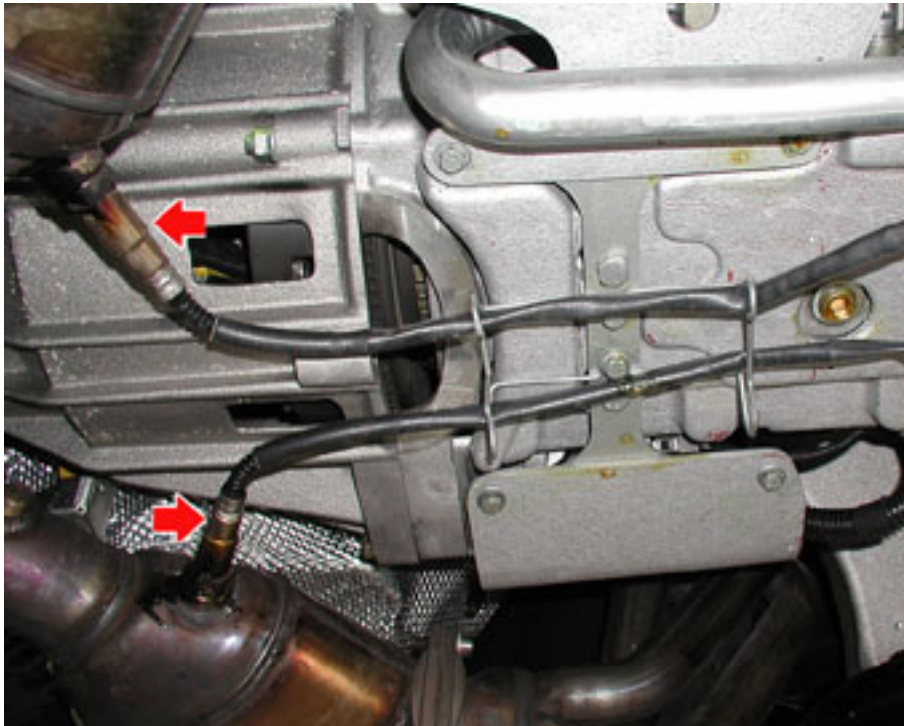

ALL VERSIONS EXCEPT USA- CANADA

- Undo the wiring fastening screws, then unscrew the Lambda sensor from the left-hand catalytic converter.

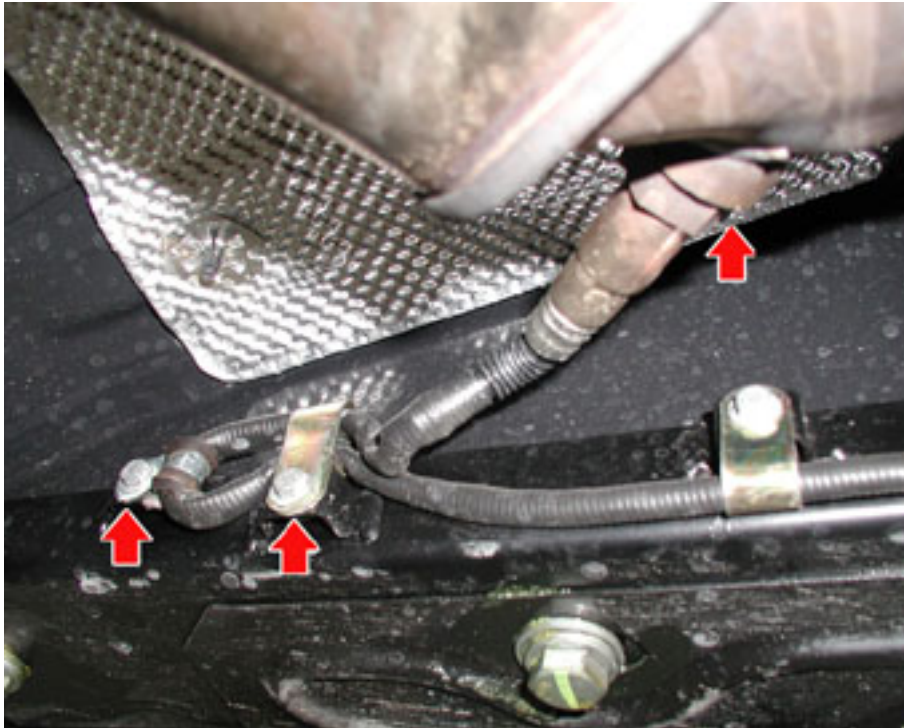

ALL VERSIONS EXCEPT USA- CANADA

- Undo the wiring fastening screws, then unscrew the Lambda sensor from the right-hand catalytic converter.

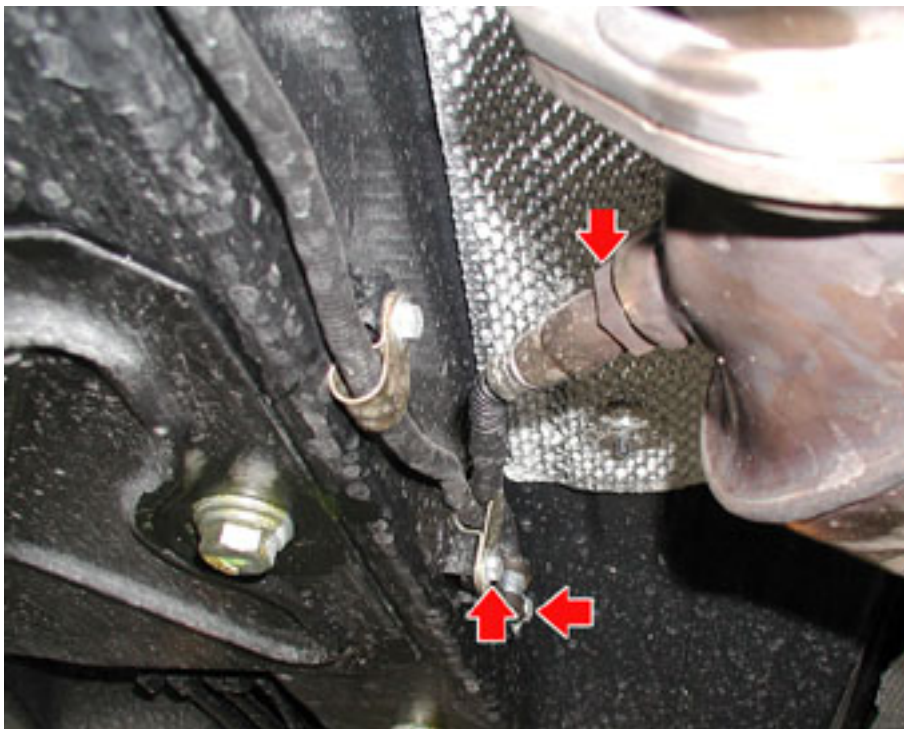

ALL VERSIONS EXCEPT USA- CANADA

- Unscrew the fastening nuts on the central catalytic converter mount.

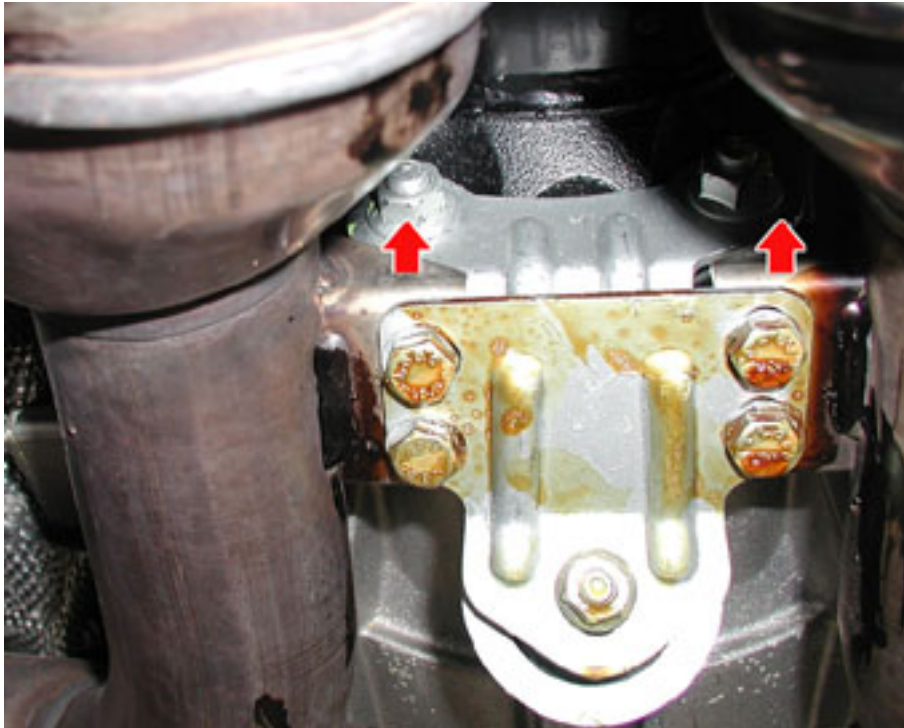

ALL VERSIONS EXCEPT USA- CANADA

- Unscrew the six screws fastening the catalytic converter to the relative manifolds.

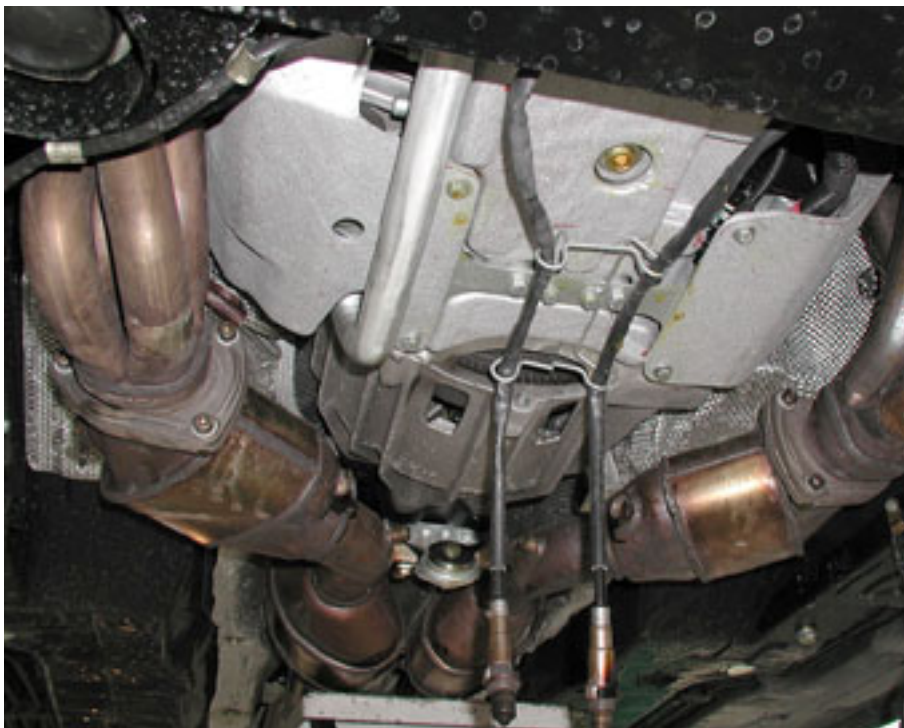

ALL VERSIONS EXCEPT USA- CANADA

- Position a hydraulic support beneath the catalytic converter/ central exhaust silencer assembly, lower it slowly, then remove the catalytic converters together with the central exhaust silencers.
- Retrieve the catalytic converter conductive gaskets.



FOR USA-CANADA VERSION ONLY

- Remove the two exhaust extensions.
Exhaust extension pipe
- Remove the central exhaust silencer.
Exhaust silencer
- Remove the floor guard beneath the engine.
Engine floor guard
- Remove the catalytic converters.
Catalytic converters

OPERATIONS VALID FOR ALL VERSIONS

- Undo the front fastening screw on the transmission shaft heat guard.

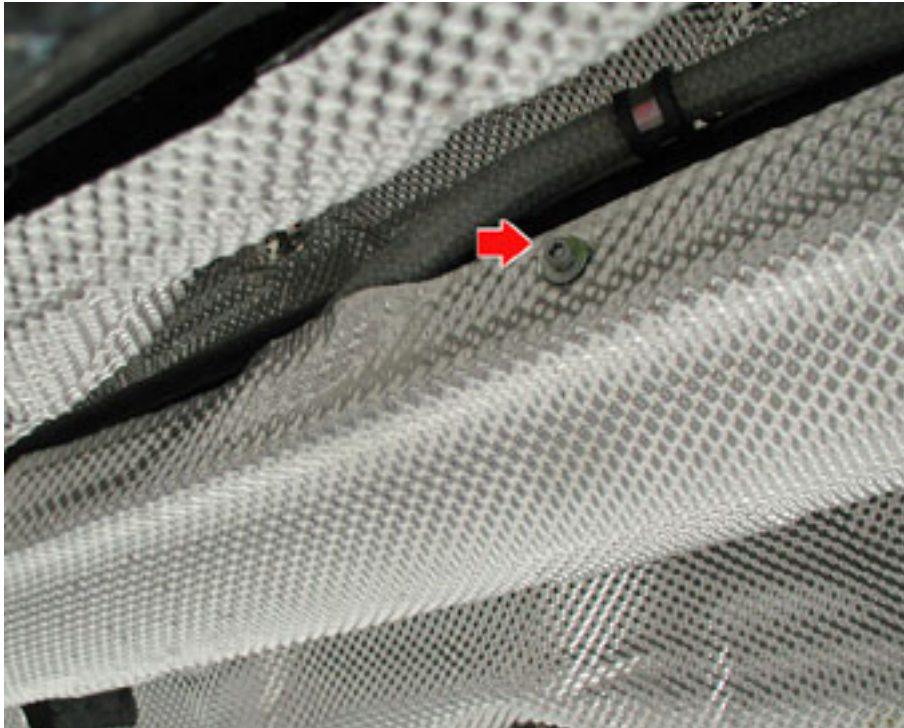

- Undo the rear fastening screws on the transmission shaft heat guard.

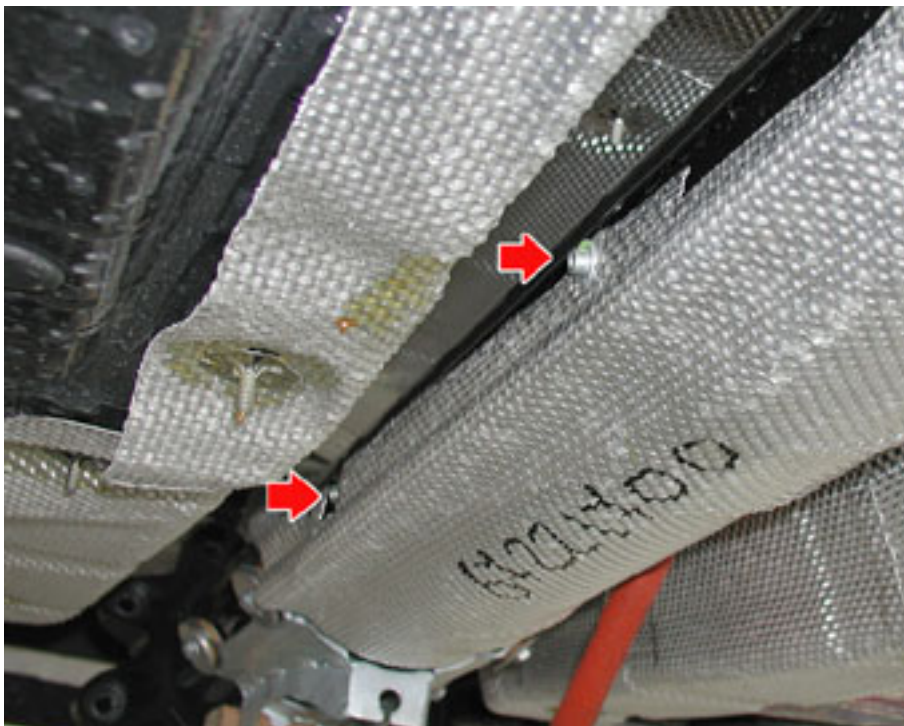

- Unscrew the nuts fastening the clutch oil line to the transmission shaft.

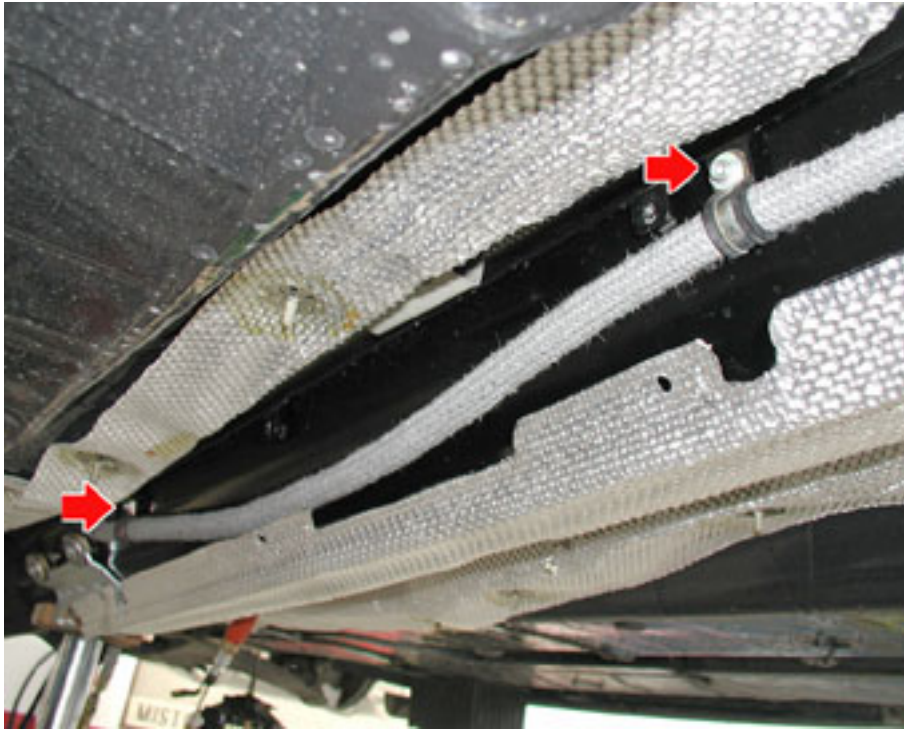

- Unscrew the nuts fastening the transmission shaft to the clutch housing.

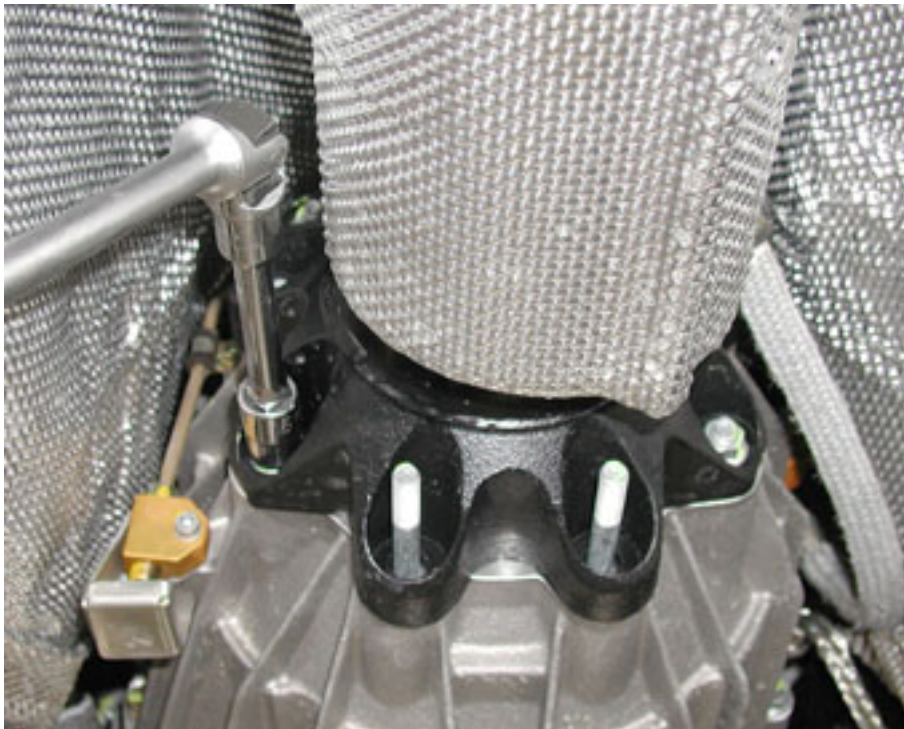

- Position tool **900027300** to support the transmission shaft during its removal and remove the rear mount placed there previously during the removal of the gearbox.
- Slide the transmission shaft out the clutch housing, then remove it.



Refitting the transmission shaft

- Using tool **900027300** to support the transmission shaft, fit the said shaft in its seat on the vehicle and engage it correctly in the seat on the clutch housing.
- Position a hydraulic support device under the rear section of the transmission shaft, screw in some of the nuts fastening the shaft to the clutch housing without tightening them fully and remove tool **900027300**.



- Tighten the nuts fastening the transmission shaft to the clutch housing to a torque of **70 Nm**.



- Tighten the nuts fastening the clutch oil line to the transmission shaft, then tighten the fastening screws on the heat guard.

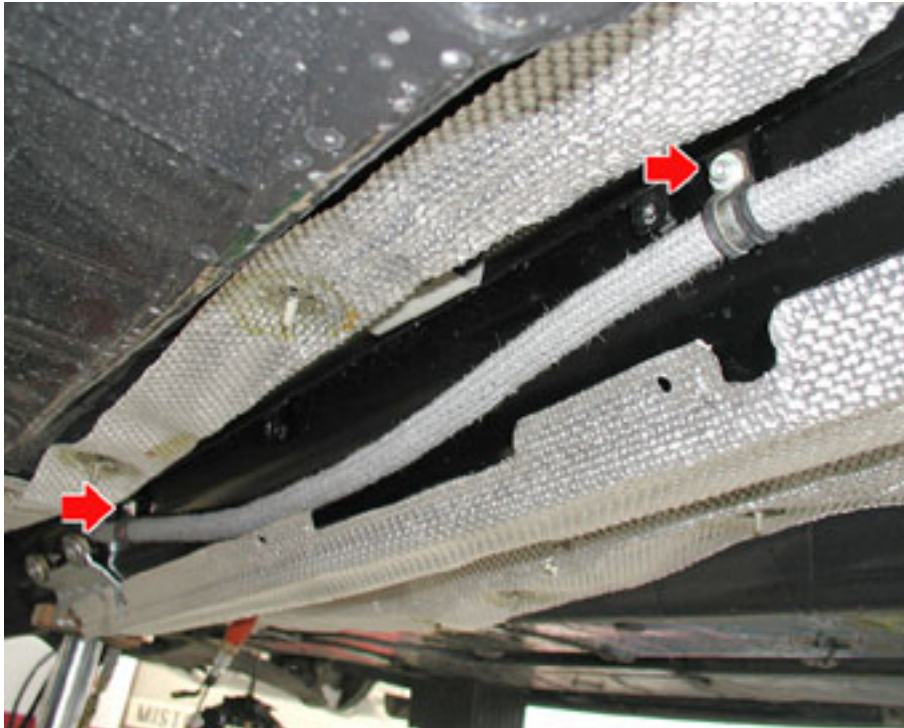

ALL VERSIONS EXCEPT USA- CANADA

- Using a hydraulic support positioned underneath the catalytic converter/central exhaust silencer assembly, position the catalytic converters in their seat together with the central exhaust silencers.

N.B.

Visually inspect that the gasket located underneath the flange joining the catalytic converter and the exhaust manifold is intact and if signs of wear are found, replace it.

N.B.

The conductive gaskets must never be fitted more than once. The second time the component is fitted, they must be replaced

- Fit the conductive gaskets.



ALL VERSIONS EXCEPT USA- CANADA

- Tighten the screws fastening the exhaust manifold to the catalytic converter to a torque of **25 Nm**.

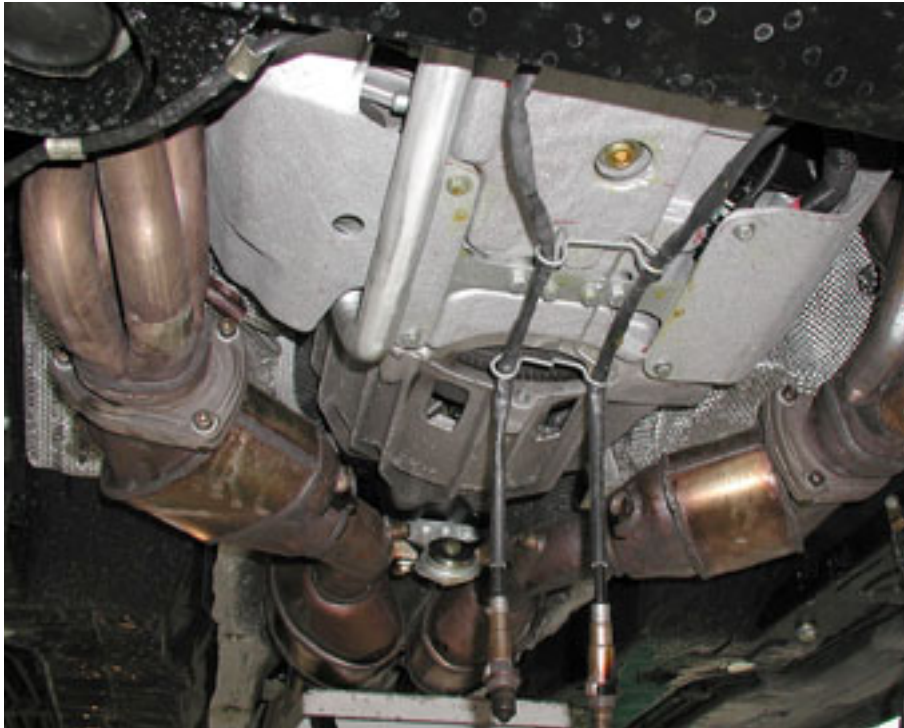

ALL VERSIONS EXCEPT USA- CANADA

- Tighten the fastening nuts on the central catalytic converter mount.

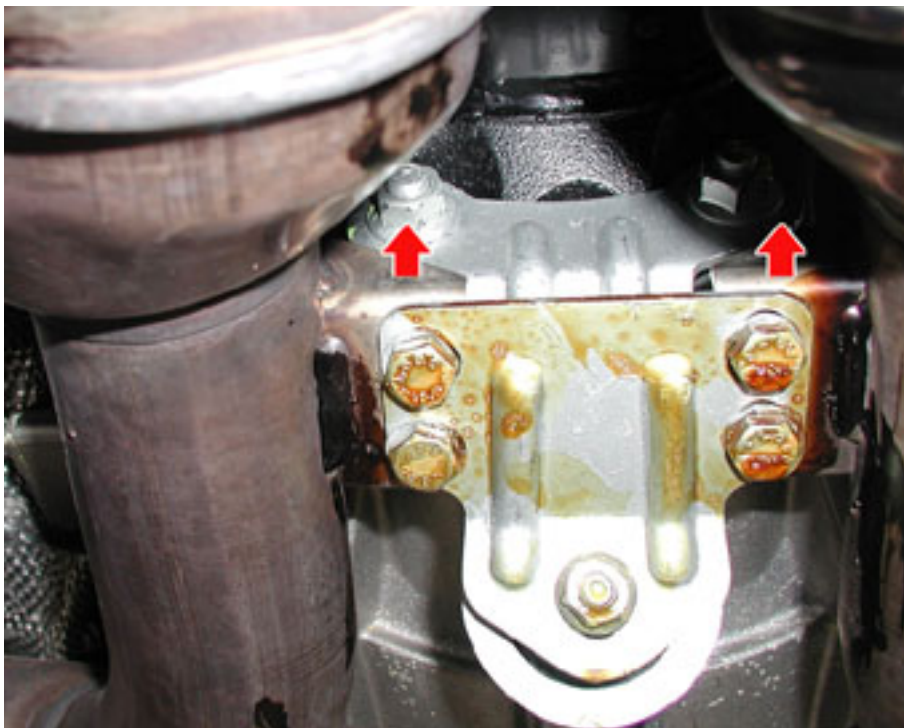

ALL VERSIONS EXCEPT USA- CANADA

- Fit all the Lambda sensors, then tighten them to a torque of **50 Nm**.
- Suitably secure the front Lambda sensor wiring to the engine frame.

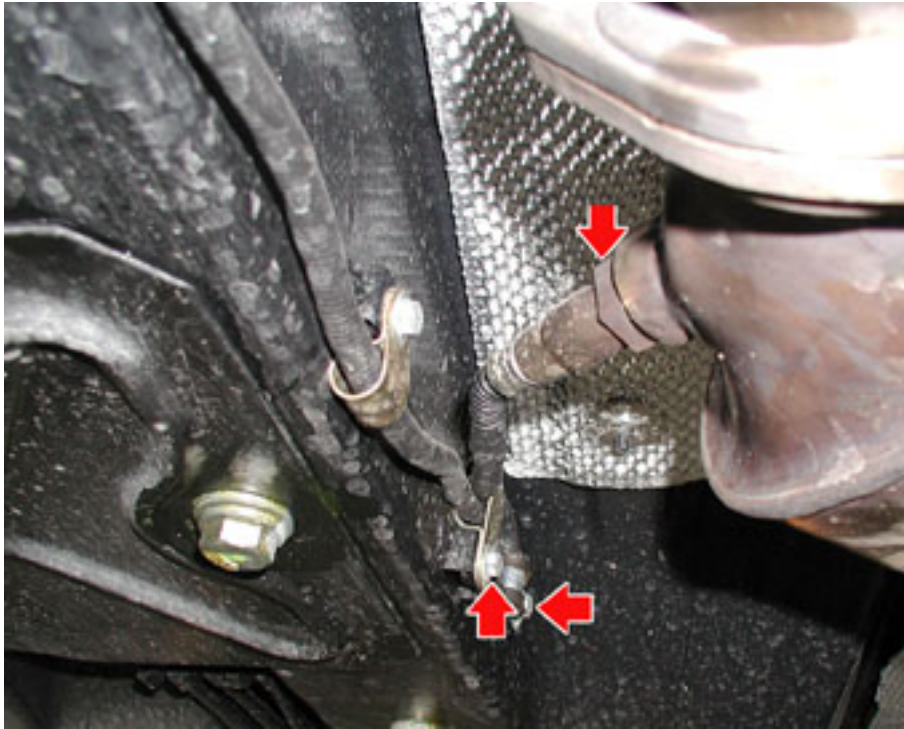

FOR USA-CANADA VERSION ONLY

- Refit the catalytic converters.
Catalytic converters
- Refit the engine floor guard.
Engine floor guard
- Refit the central exhaust silencer.
Exhaust silencer
- Refit the two exhaust extension pipes.
Exhaust extension pipe

OPERATIONS VALID FOR ALL VERSIONS

- Proceed by refitting the gearbox.
Removing-refitting the gearbox
- Proceed by refitting the exhaust tailpipes.
Removing-refitting the tailpipe

TIGHTENING TORQUES

Description	Torque	Product
Nut fastening positive and negative terminal plate on battery	5	
Nut fastening positive cables to battery link	11	
Nut fastening positive cables to branching node	15	
Screw fastening earths with stainless steel plates	15	
Nut fastening positive cable to 30+ starter motor	9	
Nut fastening earth cable onto gearbox	15	
Nut fastening earths onto welded pins	10	
Nut fastening buzzer bracket onto bodywork	8	
Nut fastening AIR-BAG ECU	8	
Nut fastening NAG ECU	8	
Nut fastening headlights set-up ECU onto mount	8	
Nut and screw fastening lower TV tuner bracket to floor	8	

EARTHS LOCATION IN THE VEHICLE

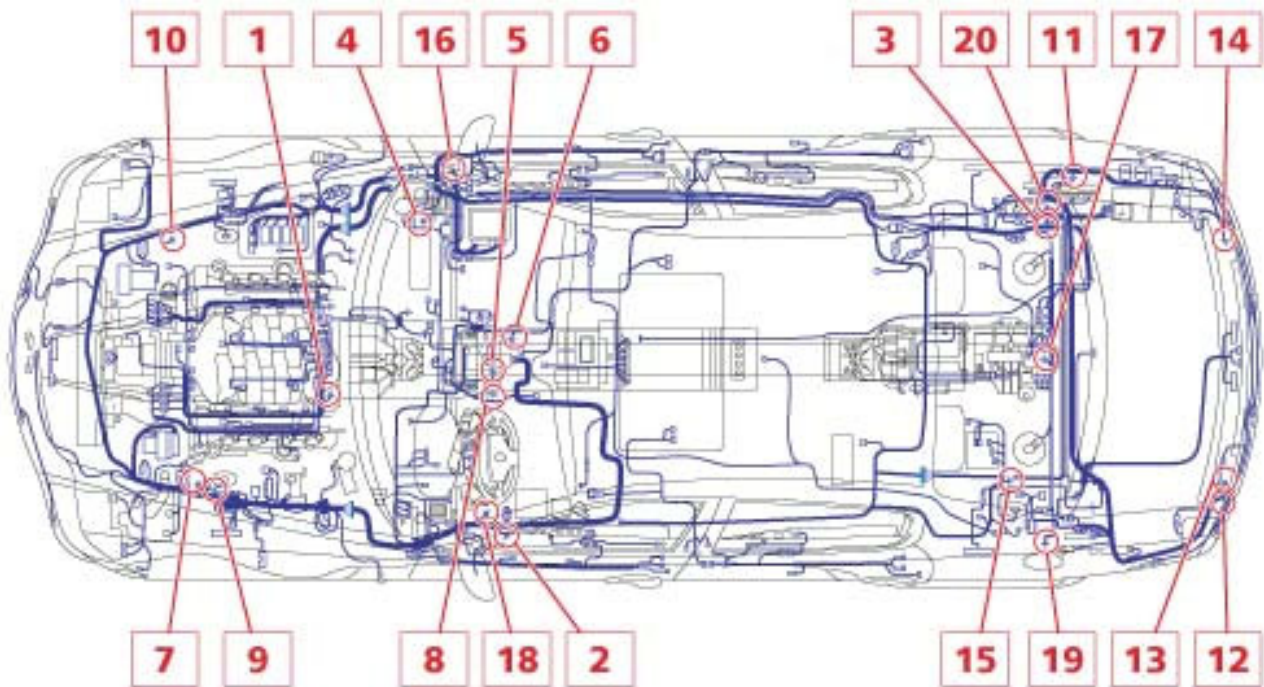

- 1.INJECTION EARTH ON ENGINE
- 2.FRONT LH EARTH
- 3.F1 GEARBOX EARTH B
- 4.INJECTION EARTH ON BODYWORK
- 5.DASHBOARD CABLE EARTH ON RH SIDE OF TUNNEL
- 6.AIRBAG EARTH ON PASSENGER COMPARTMENT CABLE
- 7.ABS EARTH
- 8.AIR-BAG ECU EARTH
- 9.FRONT LH ENGINE COMPARTMENT EARTH
- 10.FRONT RH ENGINE COMPARTMENT EARTH
- 11. EARTH AND F1 GEARBOX
- 12.LH LUGGAGE COMPARTMENT EARTH
- 13.LH LUGGAGE COMPARTMENT EARTH
- 14.RH LUGGAGE COMPARTMENT EARTH
- 15.REAR PASSENGER COMPARTMENT EARTH ON PARCEL SHELF
- 16.FRONT LH EARTH ON PASSENGER COMPARTMENT CABLE
- 17.FUEL TANK EARTH
- 18.FRONT LH EARTH
- 19.FUEL FILLER NECK EARTH
- 20. F1 GEARBOX EARTH

- 01 INJECTION EARTH ON ENGINE
- 04 INJECTION EARTH ON BODYWORK

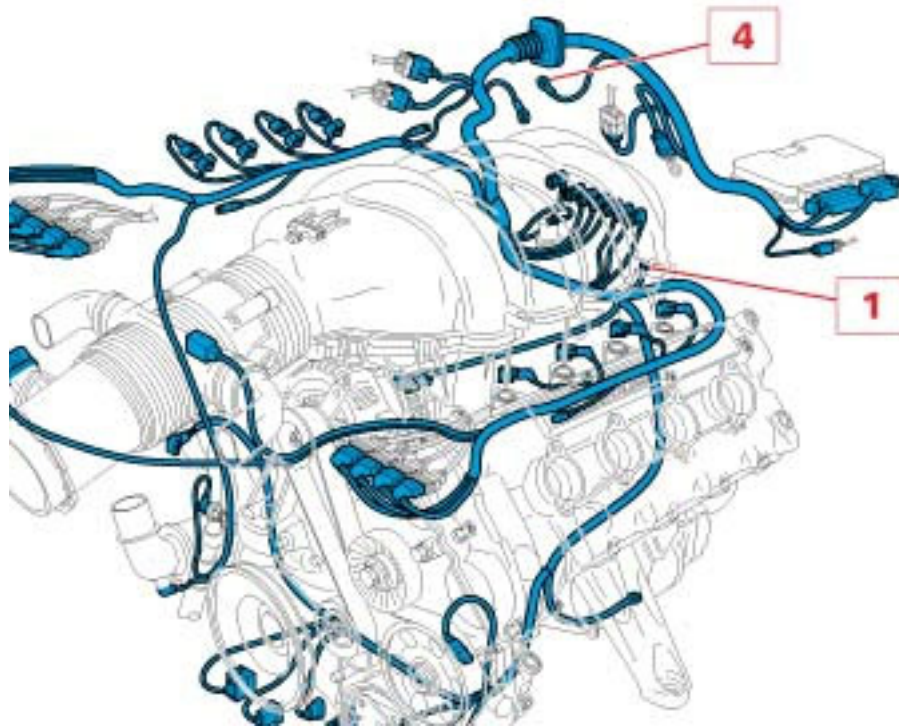

- 02 FRONT LH EARTH
- 15 REAR PASSENGER COMPARTMENT EARTH ON PARCEL SHELF
- 18 FRONT LH EARTH

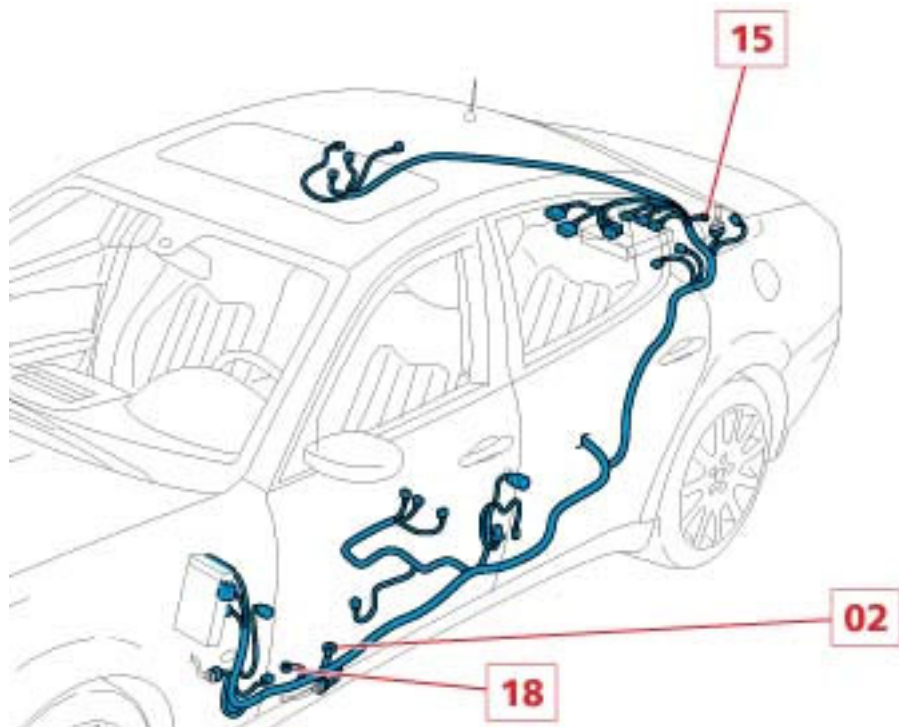

- 03 F1 GEARBOX EARTH B
- 11 EARTH AND F1 GEARBOX
- 14 RH LUGGAGE COMPARTMENT EARTH
- 20 F1 GEARBOX EARTH

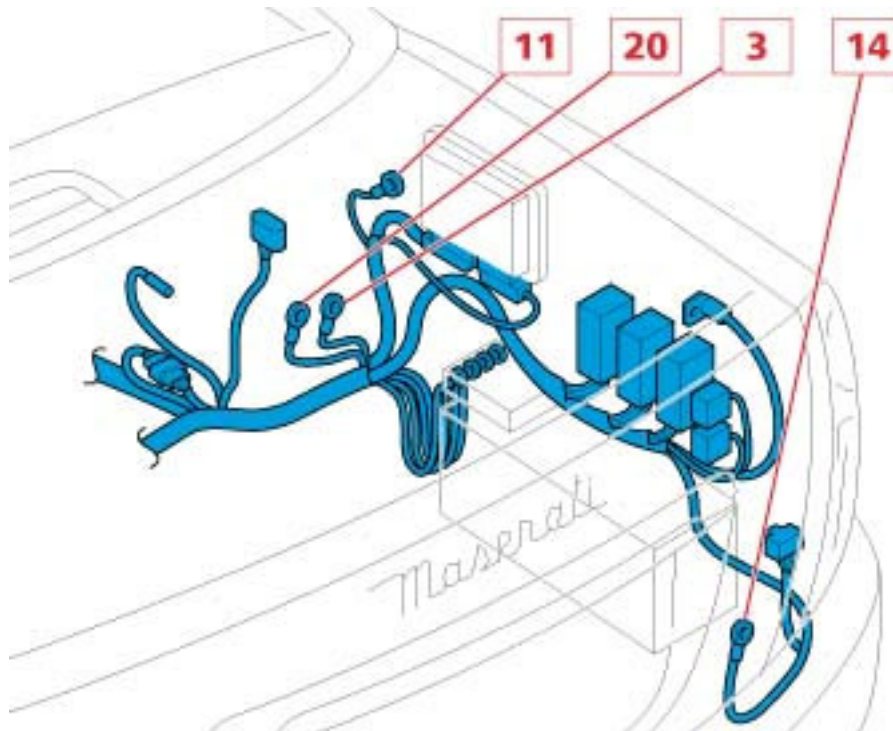

- 05 DASHBOARD CABLE EARTH ON RH SIDE OF TUNNEL
- 08 AIR-BAG ECU EARTH

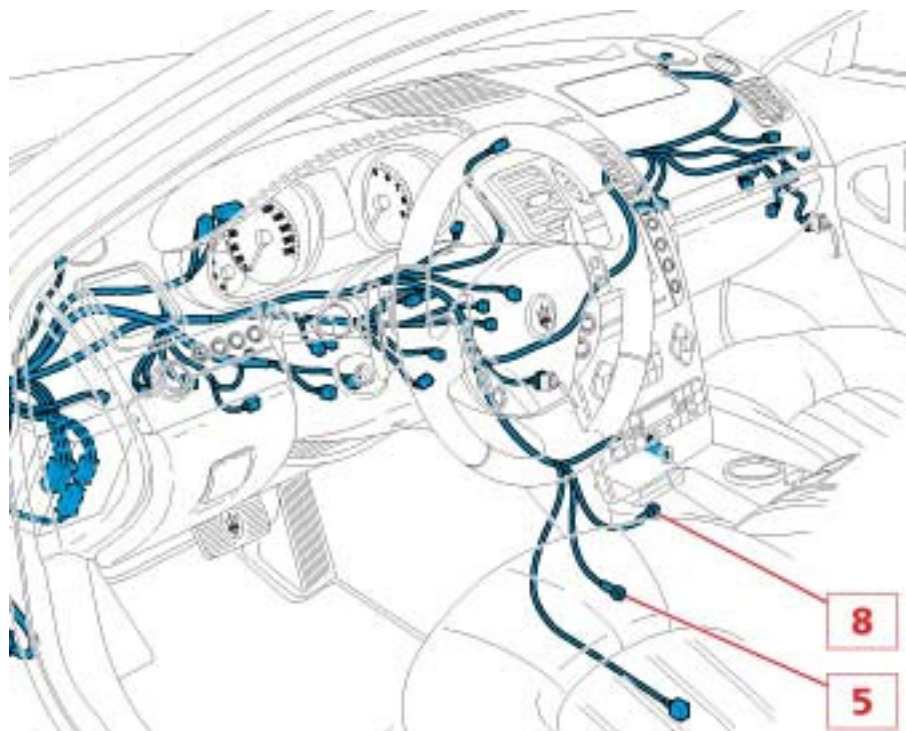

- 06.AIRBAG EARTH ON PASSENGER COMPARTMENT CABLE
- 16 FRONT LH EARTH ON PASSENGER COMPARTMENT CABLE

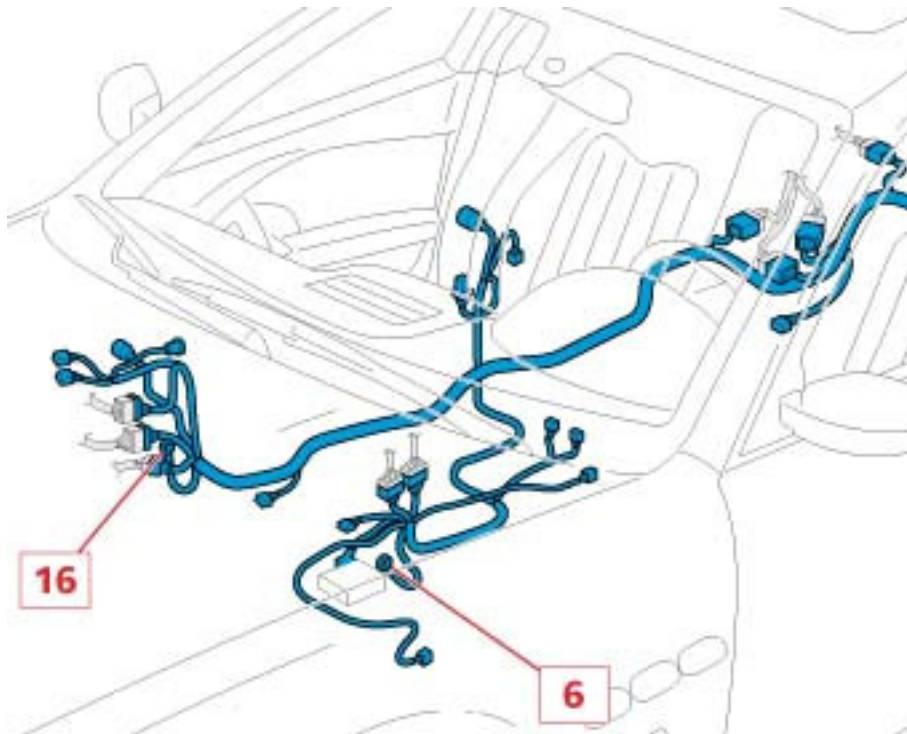

- 07 ABS EARTH
- 06 AIRBAG EARTH ON PASSENGER COMPARTMENT CABLE
- 10 FRONT RH ENGINE COMPARTMENT EARTH

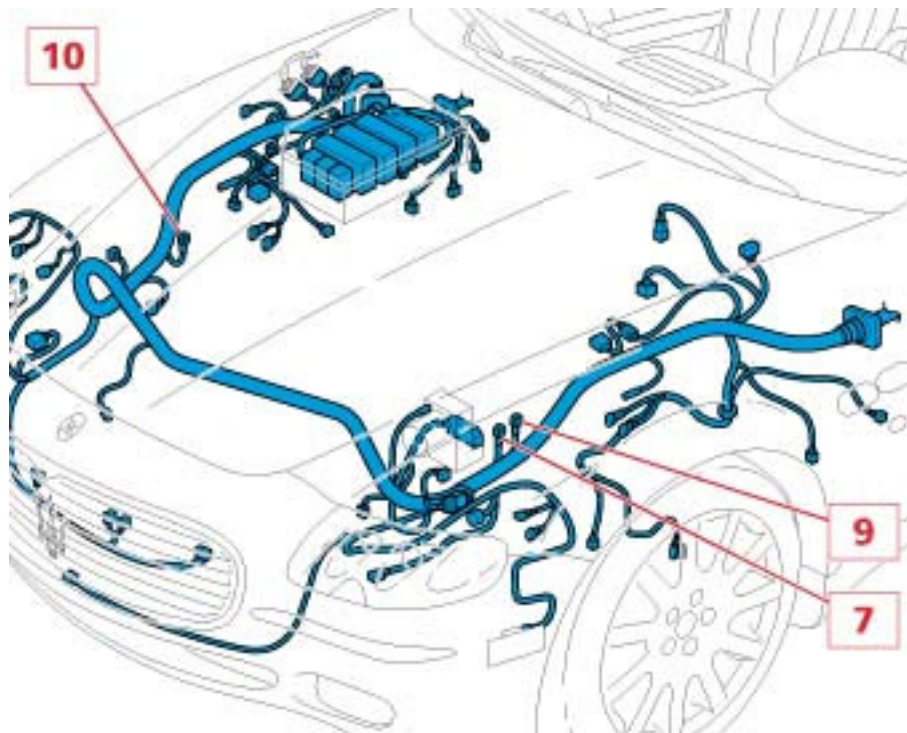

- 12 LH LUGGAGE COMPARTMENT EARTH
- 13 LH LUGGAGE COMPARTMENT EARTH

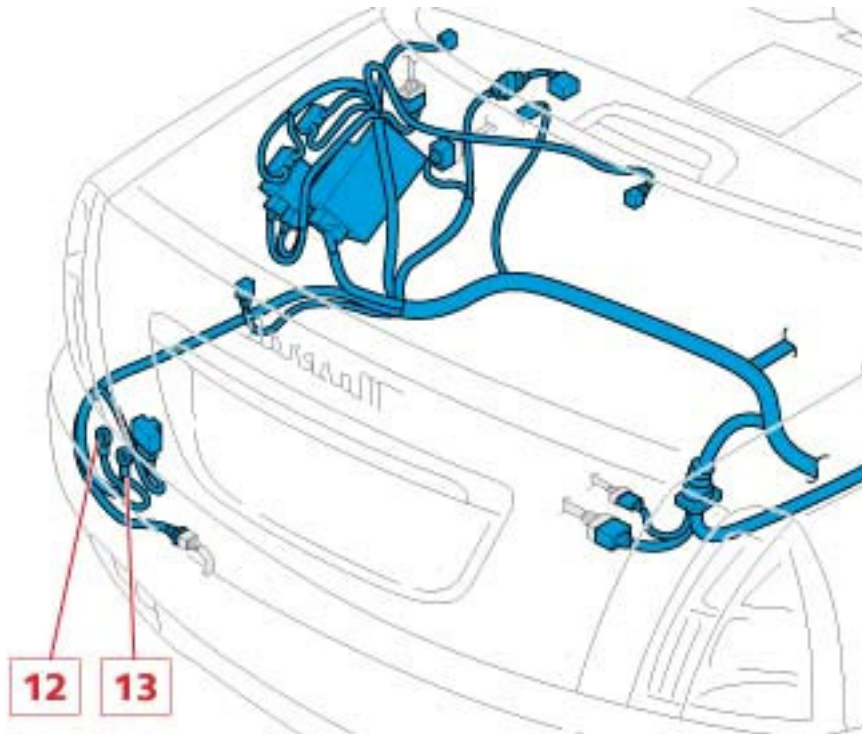

- 17 FUEL TANK EARTH
- 19 FUEL FILLER NECK EARTH

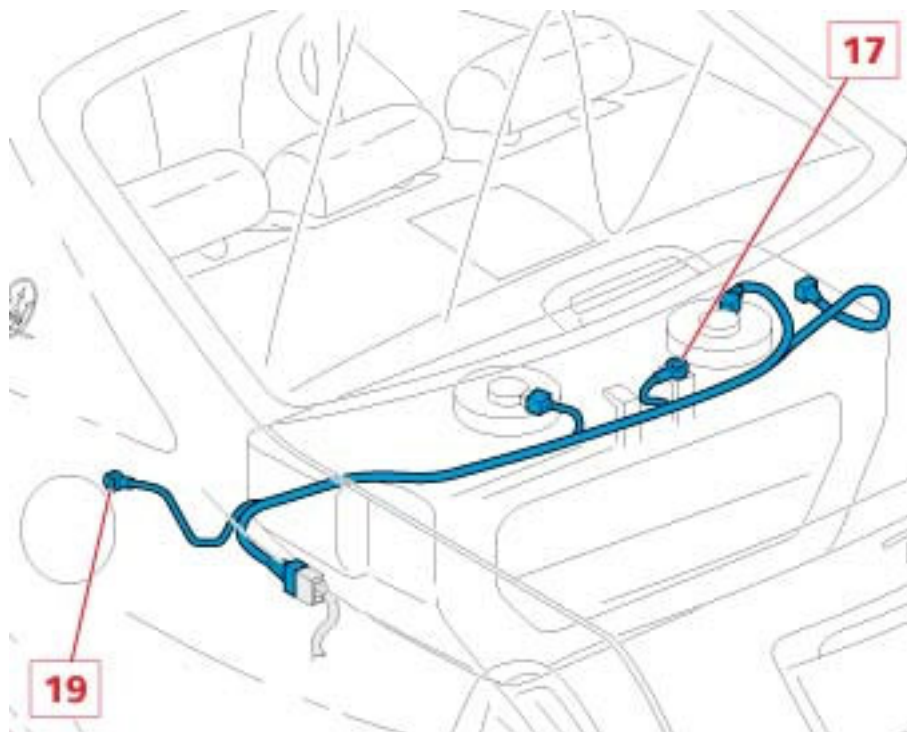

ALARM SYSTEM KIT REPLACEMENT

Removing-refitting the motion sensors

- The motion sensors are built into the ceiling lamp shown and in the event of malfunctioning, the whole ceiling lamp unit must be replaced, following the procedure outlined below.
- Disengage the motion sensors' mount from its seat.



- Detach the electrical connections and remove the motion sensors' mount.



Follow the above procedures in reverse order.

Removing-refitting the alarm system siren

- Remove the front right-hand wheel.

Replacing the wheels

- Undo the fastening screws and lever the rear section of the right-hand dust-protection guard out of its seat partially.

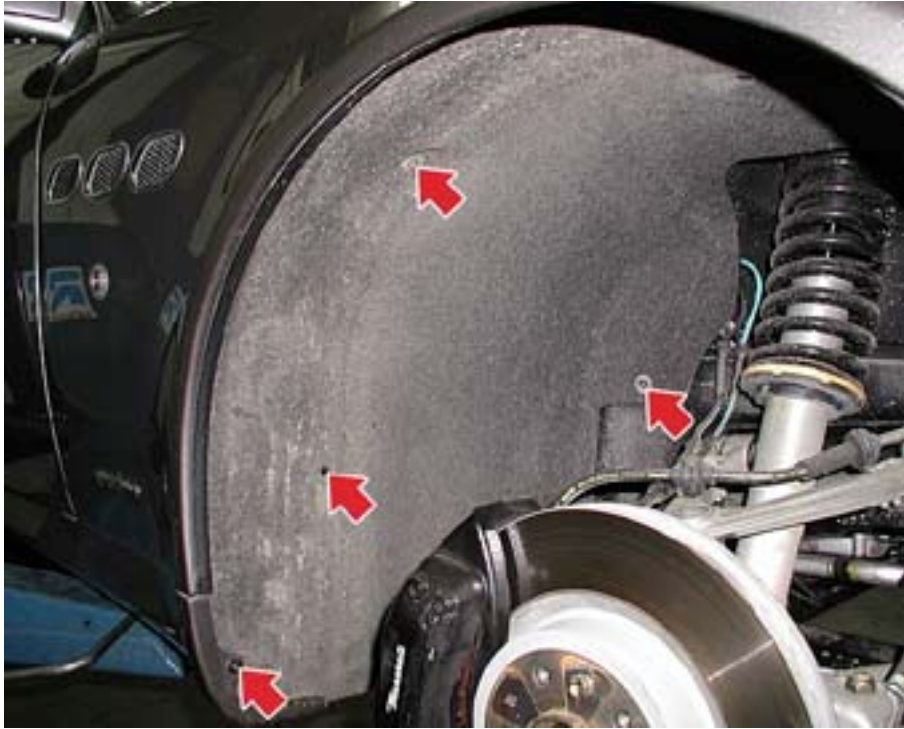

- Loosen the two fastening nuts and take the siren out of the supporting bracket.



- Detach the electrical connection and remove the alarm system siren.



Follow the above procedures in reverse order.

NEW KEY PROGRAMMING

To register a new key, you will need the electronic codes of the old keys (grey card) and, obviously, the new keys.

The SD3 tester (**95970312**) is fitted with a software package which enables the Immobilizer codes and Alarm system codes to be learnt.

When ordering new keys, you will be asked to provide the serial number of the vehicle for which the keys are required.

- Connect the SD3 tester (**95970312**) to the diagnostics socket.
- Run the PC diagnosis mode on SD3 NET.
- Start the session and access the “**RICAMBI M139**” environment.
- Start the " **Key Reprogramming** " procedure
- Enter the serial number and fill in the remaining data requested on the screen page.
- Press "CONTINUE"
- Carefully follow the procedure for programming the keys and remote controls shown on the PC.

N.B.

The programming stage cannot be considered complete until the data have been stored; Any keys not included in this procedure will not be useable.

COMPONENT SELF-LEARNING IN THE EVENT OF BATTERY DISCONNECTION

- After connecting the battery's negative terminal the following self-learning operations must be carried out to ensure that certain connected devices recognize the system again:
- **MOTOR DRIVEN THROTTLE SELF-LEARNING:**
- Set the ignition switch in the ON position (KEY ON) and wait at least 30 sec.
- **CENTRAL DOOR LOCKING:**
- Perform a door LOCK /UNLOCK operation with the remote control



- **SUNROOF:**
- Sunroof closed and key ON
- Rotate the selector switch fully to the maximum tilting position (B3 position in the previous figure, the part of the selector switch with three notches)
- press the selector switch and, keeping it pressed, wait for the sunroof to lock mechanically
- release the selector switch
- within 5 sec. press the selector switch again and keep it pressed
- after a few seconds the sunroof will start an automatic cycle (keep the selector switch pressed)
- at the end of the movement, the initialization is complete
- release the selector switch



- **IT Node (NIT) and CLOCK:**
 - When the NIT is switched on, the NIT code must be entered:
 - Using the knob on the right, enter the four-digit code which will enable you to unlock the navigator.
- **Reset the correct time by proceeding as follows:**
 - Set the ignition switch in the ON position (KEY ON)
 - Switch on IT Node
 - Press SETUP button
 - Set the correct time.
 - Before turning the ignition switch to the OFF position (KEY-OFF), wait for the clock to switch to the time set via the IT node.



- **Set the correct DATE by carrying out the following procedure:**
 - Press the SETUP button
 - Rotate the dial on the right to select the TIME and DATE options
 - Rotate the dial on the right to select the DATE option
 - Rotate the dial on the right to select the correct date and confirm it by pressing the same dial.
 - Check that the instrument panel is displaying the correct date
- **Set the information that you wish to be displayed on the instrument panel as well:**
 - Press the SETUP button
 - Rotate the dial on the right to select the VEHICLE SETUP option
 - Rotate the dial on the right to select the INSTRUMENT PANEL INFORMATION option
 - Select (ticked boxes) all three sets of information to be repeated on the instrument panel (AUDIO, NAVI and TELEPHONE)
- **Travelstore function:**
 - Press the Radio button
 - Rotate the dial on the right to select the SCANS./TS third option
 - Press the dial on the right at length (ENTER) until you hear a tone (beep).
 - Wait until the memorisation of the stations is complete.

- **Set the "SPEED LIMIT":**
 - Press the TRIP button
 - Rotate the dial on the right to select the "SPEED LIMIT" option
 - Set the alarm that is not active (empty box)
 - Set the limit to 250 km/ h

- **Set the measurement Unit for Consumption:**
 - Press the TRIP button
 - Rotate the dial on the right to select the "SETTINGS" option
 - Select "Unit for consumption"
 - Select and enter "Km/l"

- **Set the Navigation settings:**
 - Insert the navigation CD (remember that: if a Navigation CD has never been inserted in the NIT, a screen will appear on which the flash memory data will be loaded. Wait for the data loading to be completed (this will take a few seconds), then press the NAV button
 - Rotate the dial on the right to select "SETTINGS and OPTIONS"
 - Select "ROUTE OPTIONS " and confirm 'quickest route' by pressing the encoder dial on the right (coloured dot).
 - Select "SCREEN MODE" and confirm "autom. direct. indic." by pressing the encoder dial on the right (coloured dot)
 - Select "MAP VIEW" and confirm "TRAVELLING DIRECTION" by pressing the encoder dial on the right (coloured dot).
 - Select " MAP TYPE" and confirm "CAR POSITION" by pressing the encoder dial on the right (coloured dot).

SATELLITE TRACKING SYSTEM

Removing – refitting the satellite tracking system

- Remove the rear parcel shelf
Rear parcel shelf
- Remove the LH trim panel in the luggage compartment
Luggage compartment trim panels
- Working from inside the vehicle, mark the position of the GPS aerial **(1)**, the GSM aerial **(2)** and the buzzer **(3)** and disengage them from the bodywork.
- Cut the clamps fastening the vehicle wiring to the tracking system wiring.

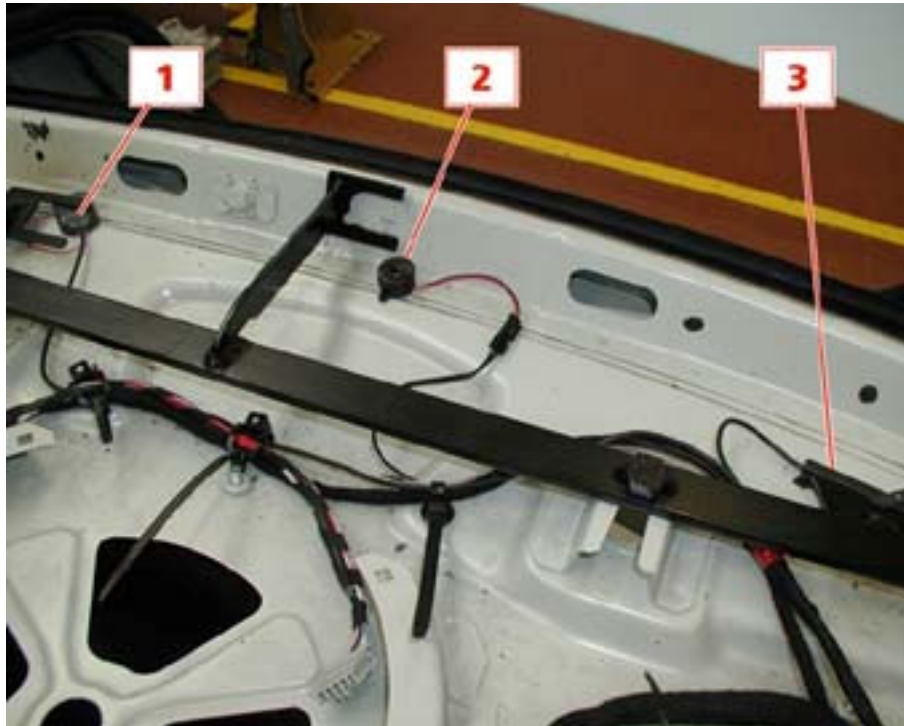

- Unscrew the lower fastening nuts **(1)** on the bracket, unscrew the upper fastening nuts (not visible, indicated with an arrow), then undo the electrical wiring fastening screw **(2)**.

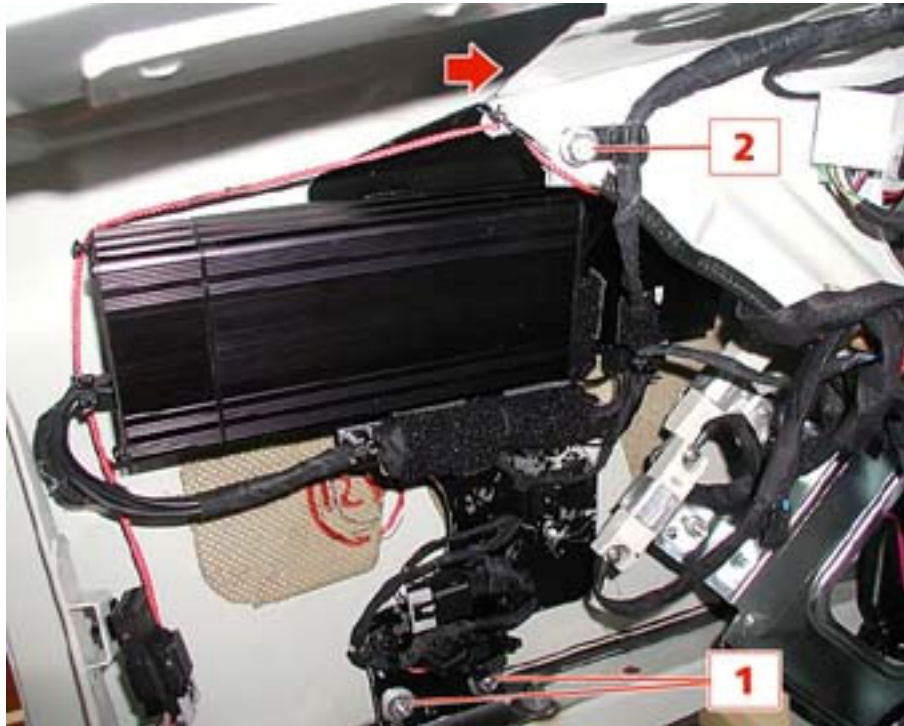

- Remove the ECUs - aerials assembly, pulling the electrical wiring out through the hole on the bodywork and taking care not to damage it.



When refitting, follow the above procedures in reverse order remembering to refit the GPS and GSM aerials and the buzzer in their original position (as marked) and fasten them with double-sided adhesive tape. Check the double-sided adhesive tape holds perfectly and that the components are fastened properly.

Disconnecting – reconnecting the satellite tracking system wiring

- Remove the ECUs - aerials assembly, as described earlier.
- Remove the adhesive tape and release the DCU/aerials control unit wiring from the GSM module cable.



- Disconnect the two connectors from the GSM module.

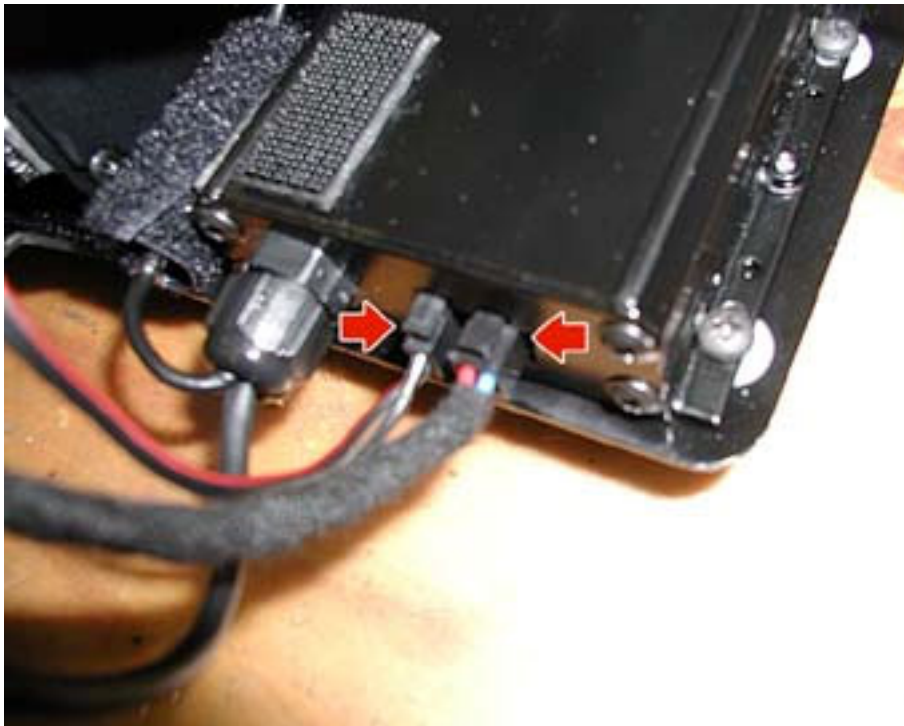

- Cut the two fastening clamps on the electric wiring.



- Release the two fuse boxes and the electrical connector from the bracket.



- Undo the four screws and remove the rear DCU module cover.

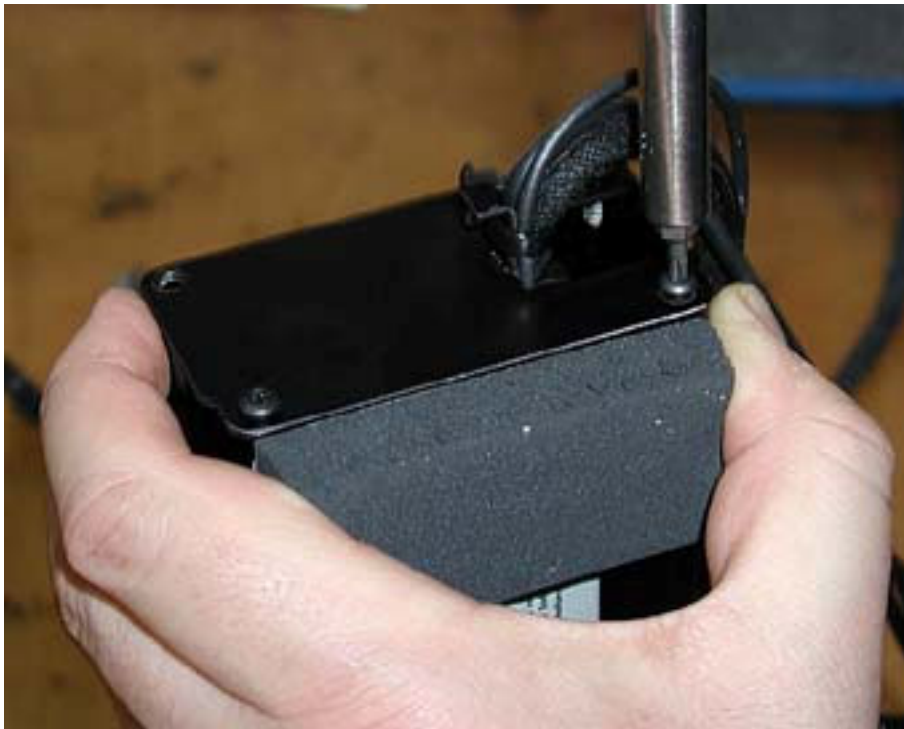

- Detach the GSM aerial connector (1) and the GPS aerial connector (2).

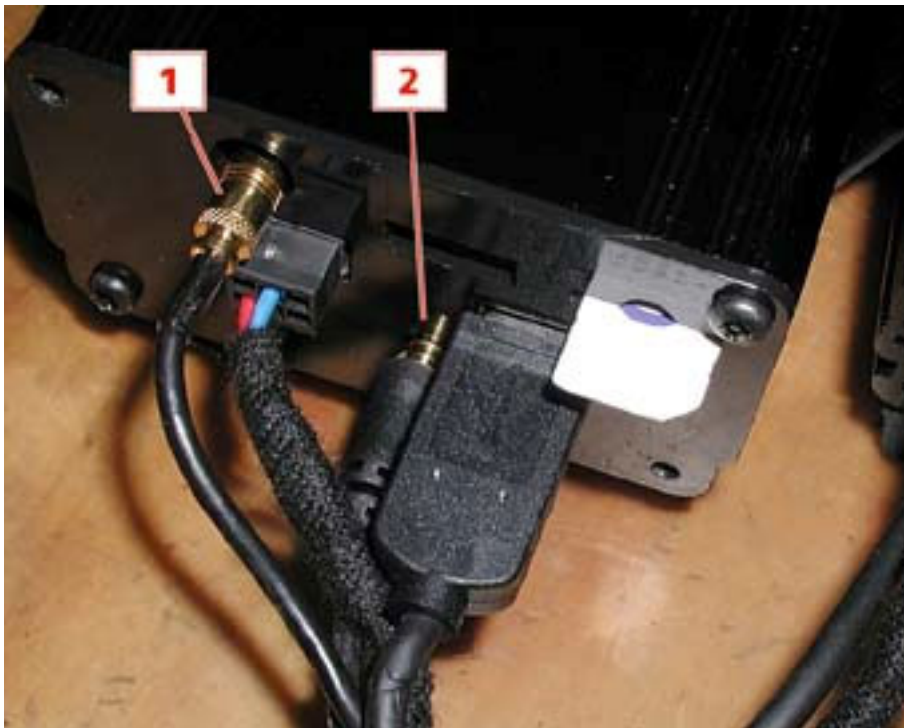

- Detach the GSM aerial connector (1) and the GPS aerial connector (2).

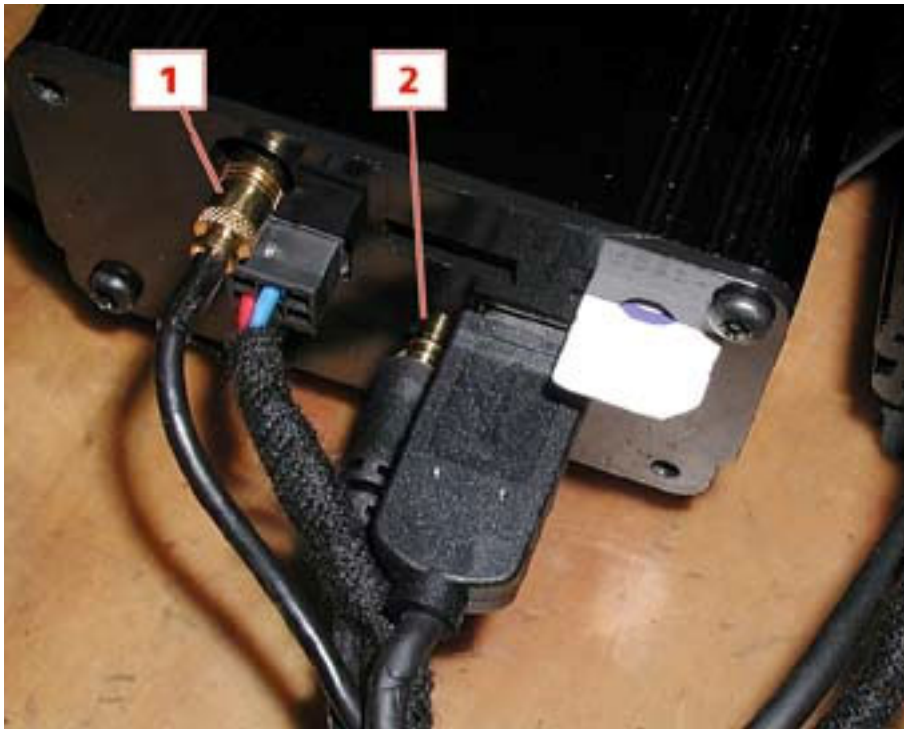

- Peel off the adhesive tape and detach the connection beneath it, then remove the wiring complete with the aerials and buzzer.



When refitting, follow the above procedures in reverse order.

Removing – refitting the GSM module

- Remove the ECUs - aerals assembly, as described earlier.
- Remove the adhesive tape and release the DCU/aerals control unit wiring from the GSM module cable.



- Disconnect the two connectors from the GSM module.

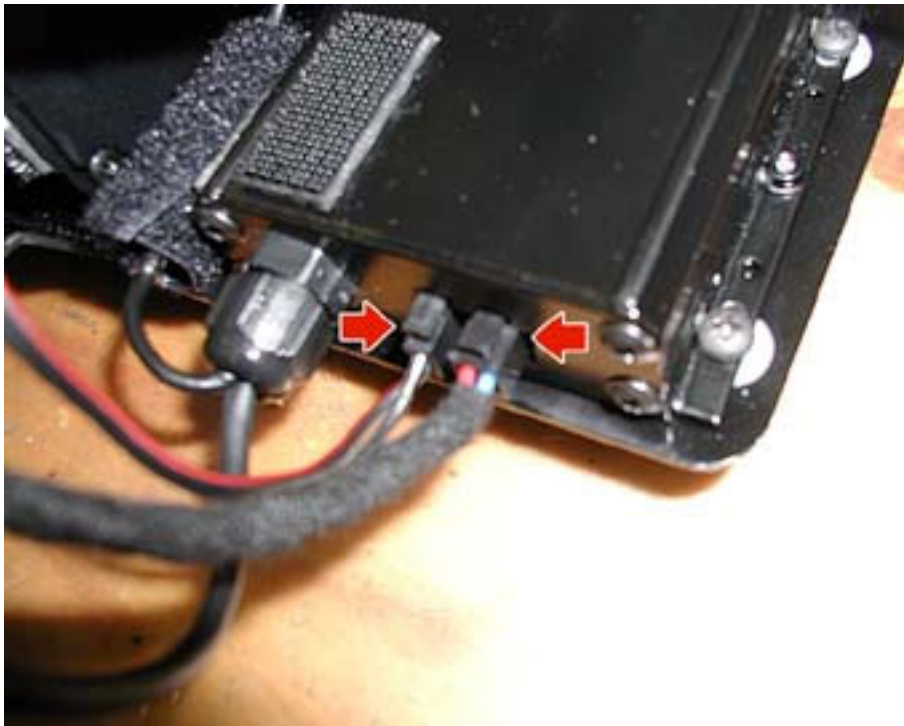

- Undo the four screws and remove the rear DCU module cover.



- Detach the USB connector (1) on the GSM module from the DCU module.

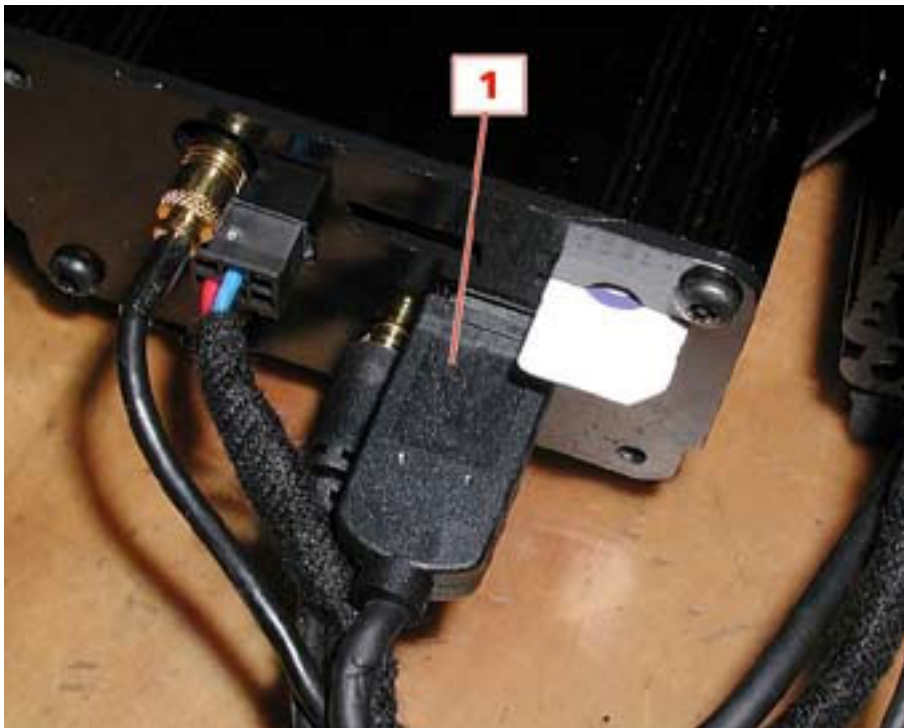

- Peel off the adhesive tape and detach the connection beneath it.



- Undo the screws fastening it to the bracket and remove the GSM module.



When refitting, follow the above procedures in reverse order.

Removing – refitting the DCU module.

- Remove the ECUs - aerials assembly, as described earlier.
- Cut the two fastening clamps on the electric wiring.



- Undo the four screws and remove the rear DCU module cover.



- Detach all the connectors from the DCU module.



- Release the fastening clips and remove the DCU module from the bracket.



When refitting, follow the above procedures in reverse order.

Replacing the system's protective fuses

- Remove the LH trim panel in the luggage compartment
Luggage compartment trim panels
- The two protective fuses are located in the boxes (1) fastened to the bracket holding the modules assembly.

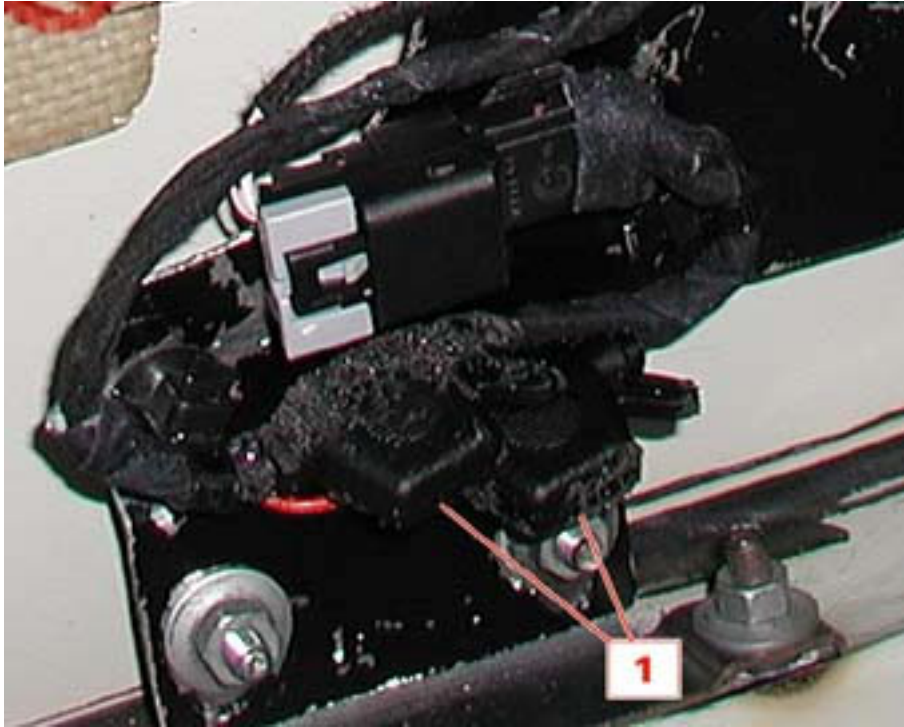

- Open the protective cap and replace the fuse with one with the same specifications.



- Lower the motor and release the driving gear from the cables on the shoes.
- Take care not to move the driving cables; any movement which is not simultaneous with the cables' could cause a malfunction of the sunroof movement.

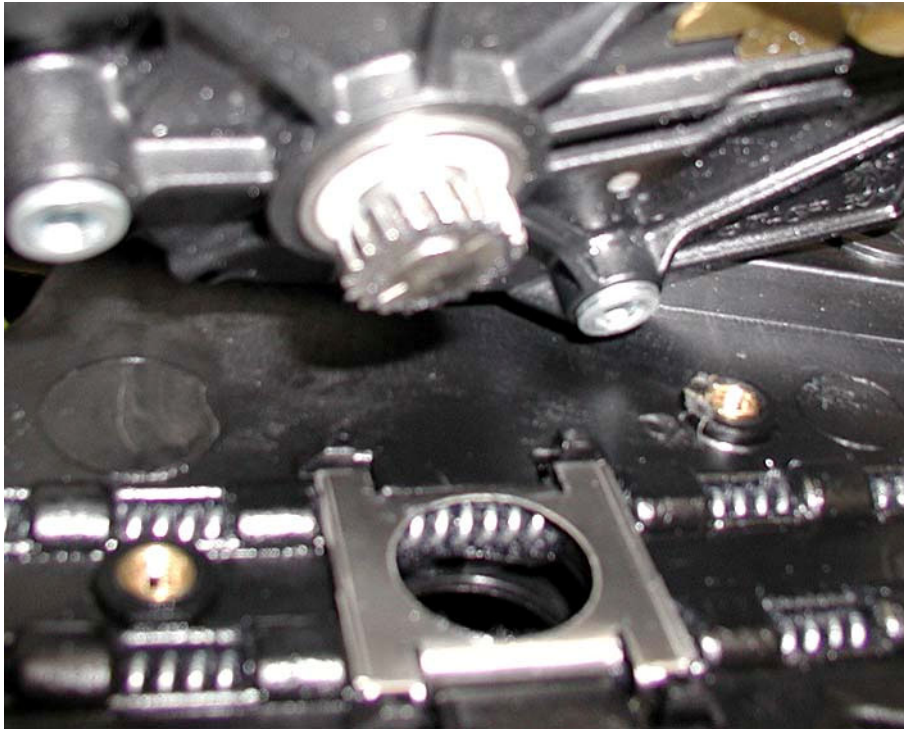

When refitting, follow the above procedures in reverse order

- After connecting the negative battery terminal, the following self-learning operations must be carried out to ensure certain connected devices acknowledge the system again.
- Refer to section:

Component self-learning in the event of battery disconnection

SUNROOF WINDOW

Removing the sunroof window

- Make sure the sunroof is closed in the sliding mode, but open in the tilting mode.
- Working on both sides, remove the guard snap-fitted onto the runners by means of the catches shown.

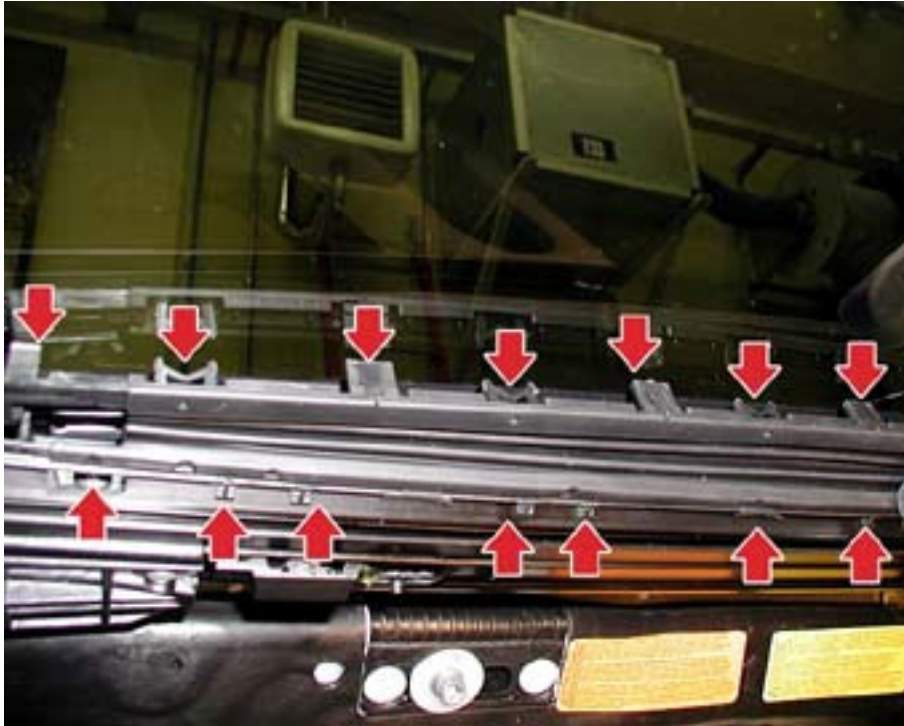

- Undo the screws (two per side) fastening the sunroof window to the runners.



- Remove the sunroof window, taking care not to damage the paint on the vehicle. Place the window on a perfectly clean surface to ensure nothing can scratch the glass.



- Check the degree of wear of the window's outer strip and if it is damaged, replace it.
- To replace the strip, simply remove it from its seat on the window, and then mount a new one, making sure it fits perfectly around the edge of the window.



Refitting the window into the sunroof

- Fit the window into the sunroof and rotate the screws fastening the window to the runners (two per side) without tightening them fully.
- Adjust the window by moving it in the directions shown by the arrows, aligning it correctly with the outer edge on the roof bay. When the adjustment procedure is complete, tighten the fastening screws on the window.

N.B.

Check that the gap between the window and the roof is even.



- Working on both sides, fit the guard onto the runners using the snap-fittings shown.

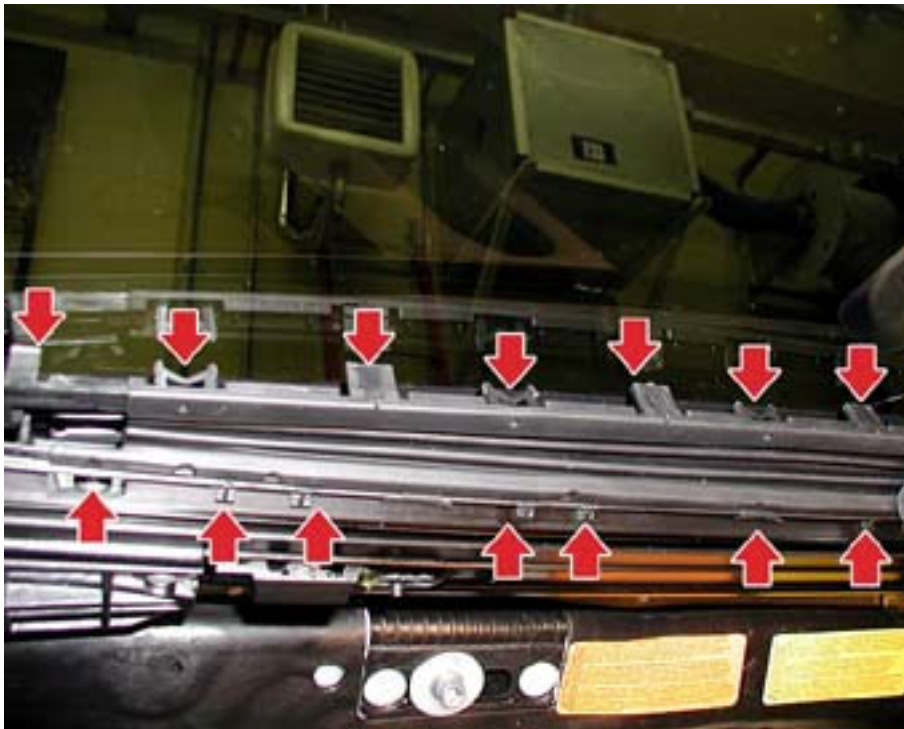

DRAINAGE CHANNEL

Removing - refitting the drainage channel

- Move the sunroof to the closed position.
- Disconnect the battery's negative terminal.
- Remove the roof trim panel.

Removing-refitting the roof lining

- Remove the electric sunroof.

Removing - refitting the electric sunroof

- Working on both sides, disconnect the channel driving rope.



- Working on both sides, release the drainage channel from the clamping devices.



- Check that the fastening devices on the drainage channel are intact and, if damaged, replace them removing the stroke limit stops and sliding them out of the sunroof frame.



When refitting, follow the above procedures in reverse order

SUNROOF SHADE

Removing - refitting the sunroof shade

- Remove the sunroof window.
Removing - refitting the sunroof shade
- Working on both sides, disconnect the driving rope and move the drainage channel backwards.



- Push the four shoes on the shade (two per side) inwards and release them from the runners.



- Lift the sunroof shade up and remove it.



When refitting, follow the above procedures in reverse order

SUNROOF SPOILER

Removing - refitting the sunroof spoiler

- Move the sunroof window backwards in order to gain access to the spoiler fastening screws.
- Proceeding on both sides, undo the fastening screws on the spoiler.



- Lift up the spoiler, release it from the hooking means, then remove the spoiler itself.

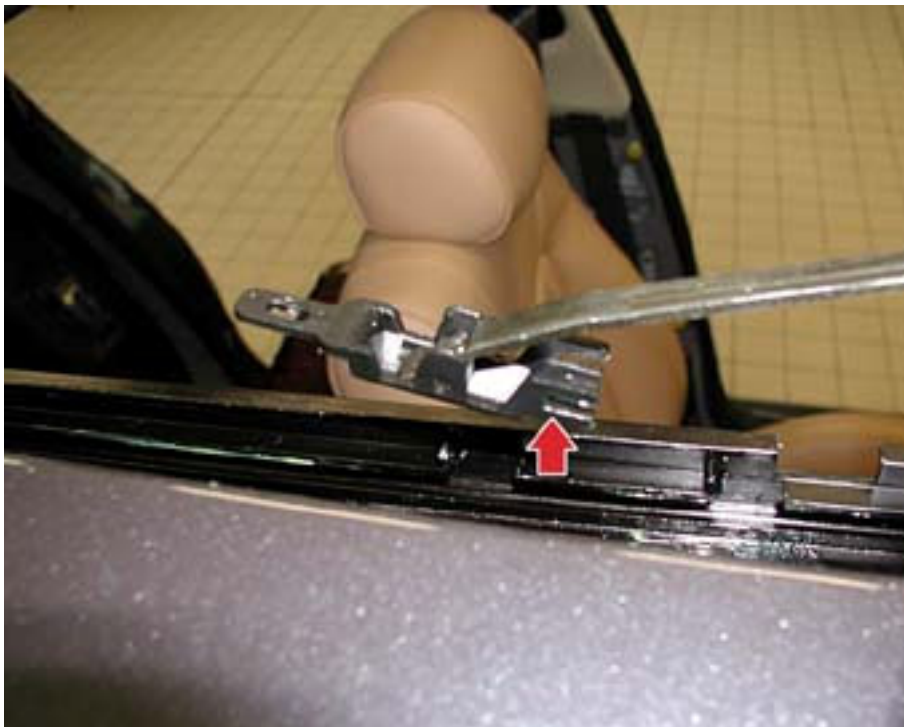

When refitting, follow the above procedures in reverse order

SUNROOF SLIDING RUNNERS

Removing the sunroof sliding runners

- Move the sunroof to the closed position.
- Disconnect the battery's negative terminal.
- Remove the roof trim panel.

Removing-refitting the roof trim panel

- Remove the electric sunroof.

Removing - refitting the electric sunroof

- Remove the sunroof drainage channel.

Removing - refitting the drainage channel

- Using the hexagonal hole on the motor, move the runners manually to the "window fully closed" position.
- Mark the position of the hole (1) (through-hole for window fastening) on the frame (2), to ensure it is perfectly aligned when refitted.

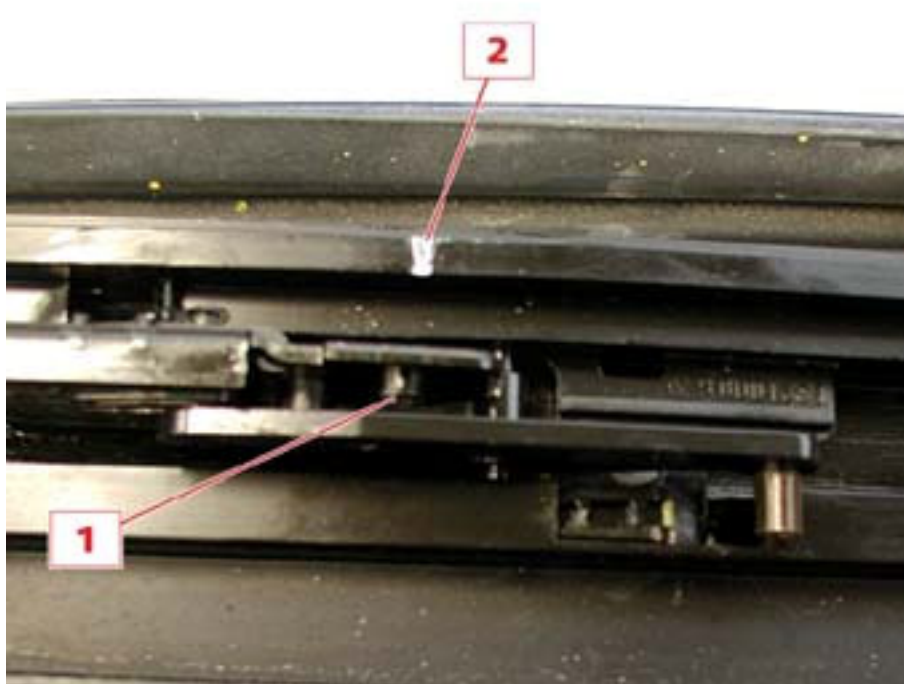

- Remove the sunroof control motor.

Removing - refitting the sunroof control motor

- Push the sunroof in the direction indicated by the arrow, lift it and remove the stroke-limit stop on the sliding runners.



- Move the sliding runner towards the rear of the frame, until you are able to remove it from the frame itself.



- Move the driving rope backwards and release the pin (1) from its seat on the runner (2), then remove the sliding runner.



Refitting the sunroof's sliding runner

- Fit the driving rope's pin (1) into the runner and slide it along the runner until the pin (2) is positioned in its seat (3) on the runner.

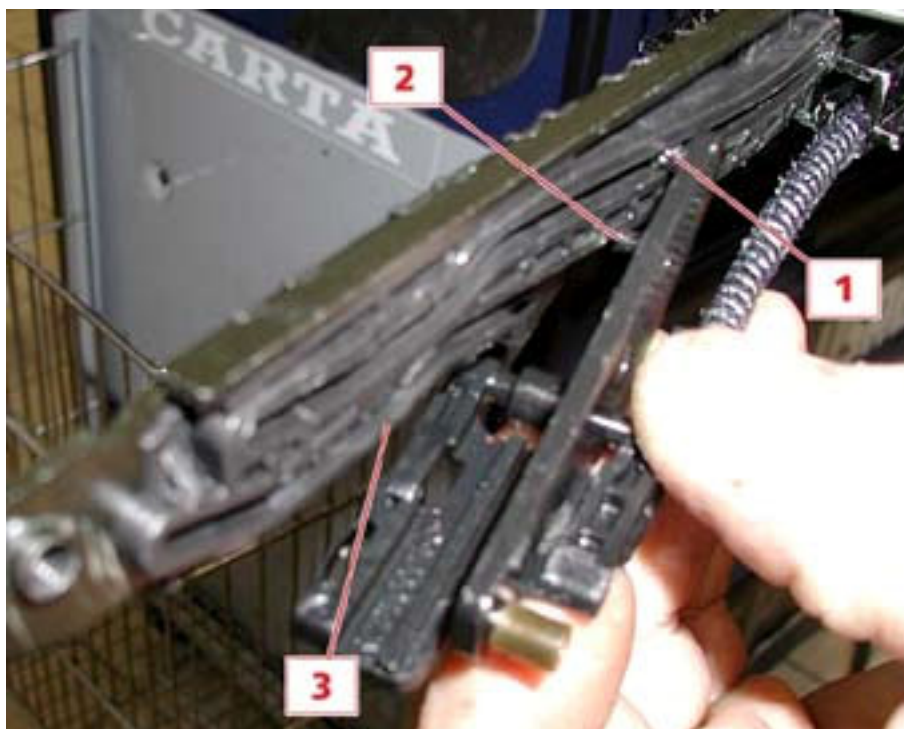

- Push the runner in its seat on the frame until it reaches the stroke limit.



- Fit the stroke stop on the sliding runners.



- Check that hole (1) on the sliding runner matches up with the mark (2) made on the frame. If this is the case, the runners are aligned once again.

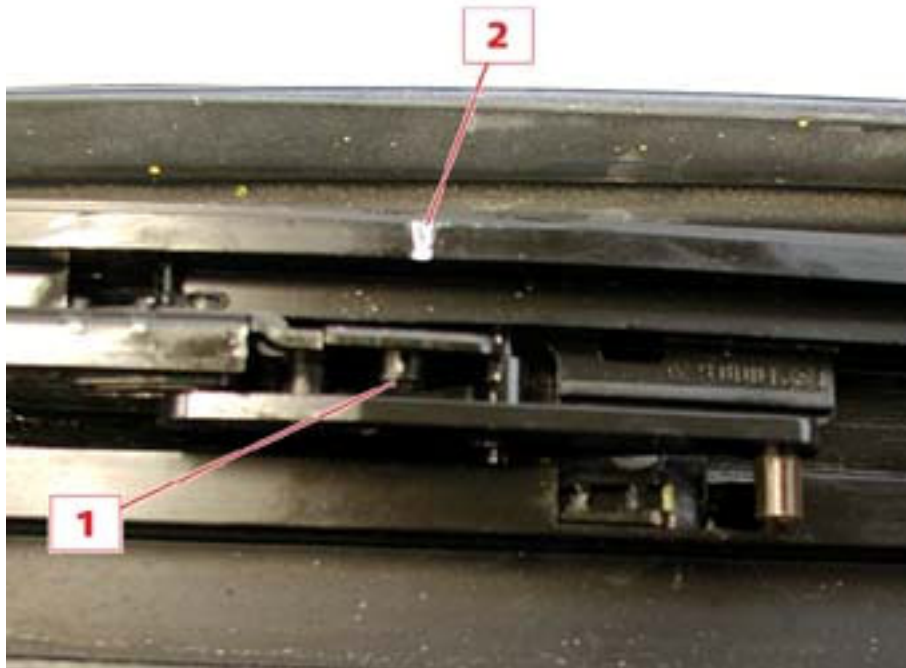

- Proceed to refit the components as for their removal, but in reverse order.

SUNROOF RUNNER ALIGNMENT

Sunroof runner alignment

- Remove the sunroof window.

Removing - refitting the sunroof shade

- Remove the sunroof control motor.

Removing - refitting the sunroof control motor

- Move both the shoes manually to the "spoiler" position on both sides, following the direction indicated by the arrow.

- Refit the motor.

Removing - refitting the sunroof control motor

- Refit the sunroof on the pantograph carriages, adjusting the position as required, in order to ensure both the alignment and the weather strip seal are perfect.

Removing - refitting the sunroof shade

N.B.

In these conditions, both driving ropes will be in the same position, aligned in the "SPOILER" position.



SUNROOF SELECTOR SWITCH

Removing - refitting the sunroof selector switch

- Remove the selector switch from its seat by releasing one of the two fastening clips.



- Detach the electrical connection and remove the sunroof selector switch.



When refitting, follow the above procedures in reverse order

BODY COMPUTER NODE (NBC)

Removing - refitting the body computer node (NBC)

- Disconnect the battery's negative terminal.

For all versions except the USA-CANADA version, remove the driver's side glove compartment

Driver's glove compartment

- For the **USA –CANADA version**, remove the NBC guard, proceeding as follows.
- Unscrew the lower fastenings on the Body Computer Node guard.



- Extract the pins (1) from the holes fitted with rubber antifriction bushings (2), and remove the Body Computer Node guard (3).

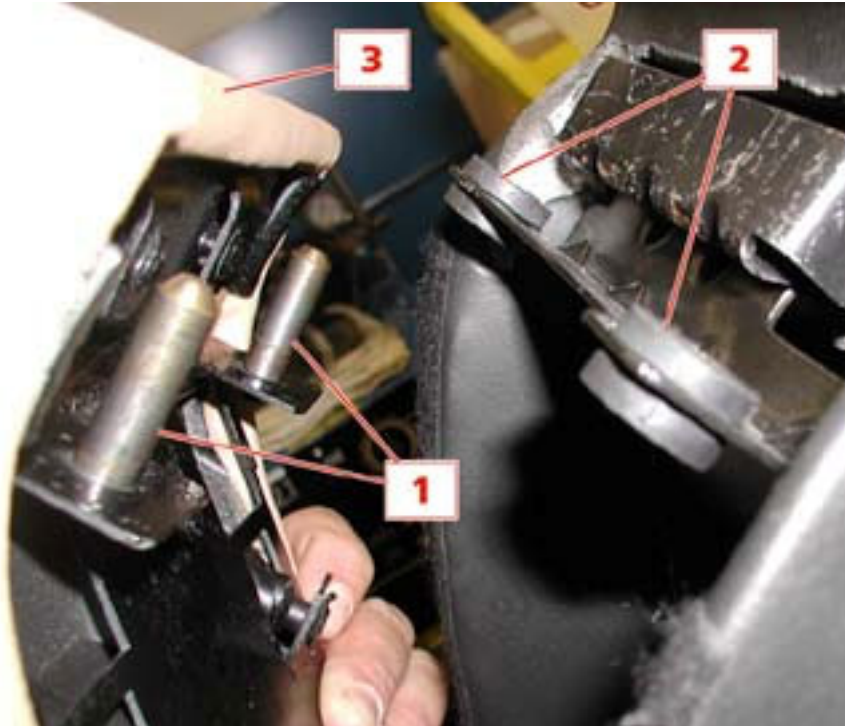

The operations below apply to all versions and markets.

- Detach the electrical connections at the front and undo the two fastening screws on the body computer node.

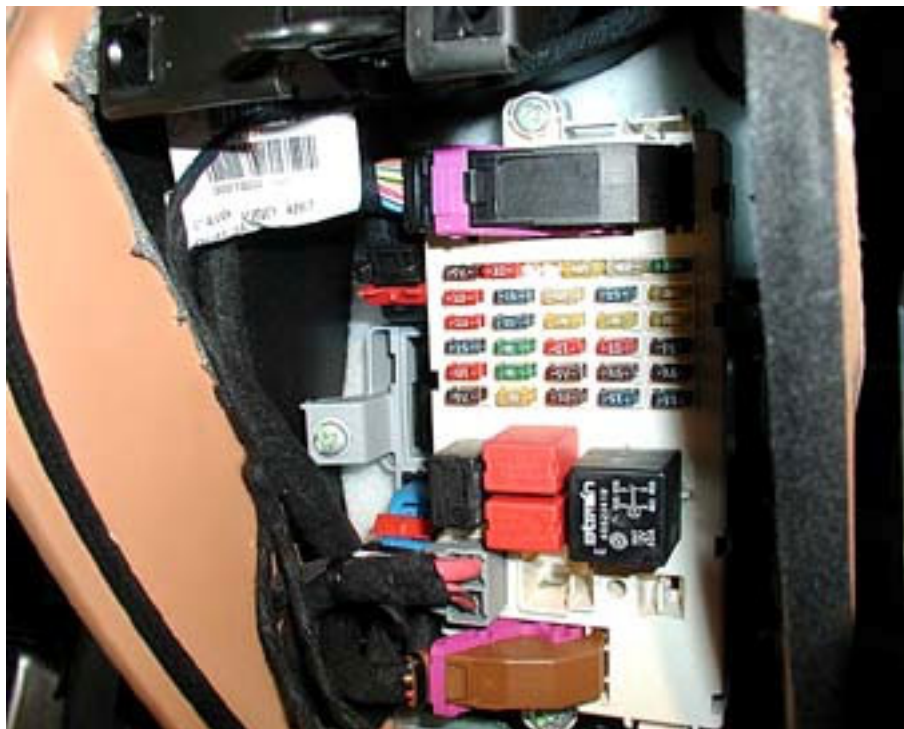

- Rotate the body computer node, detach the electrical connections on the rear section and remove the part.



- If necessary, separate the body computer node (1) from the dashboard node (2).

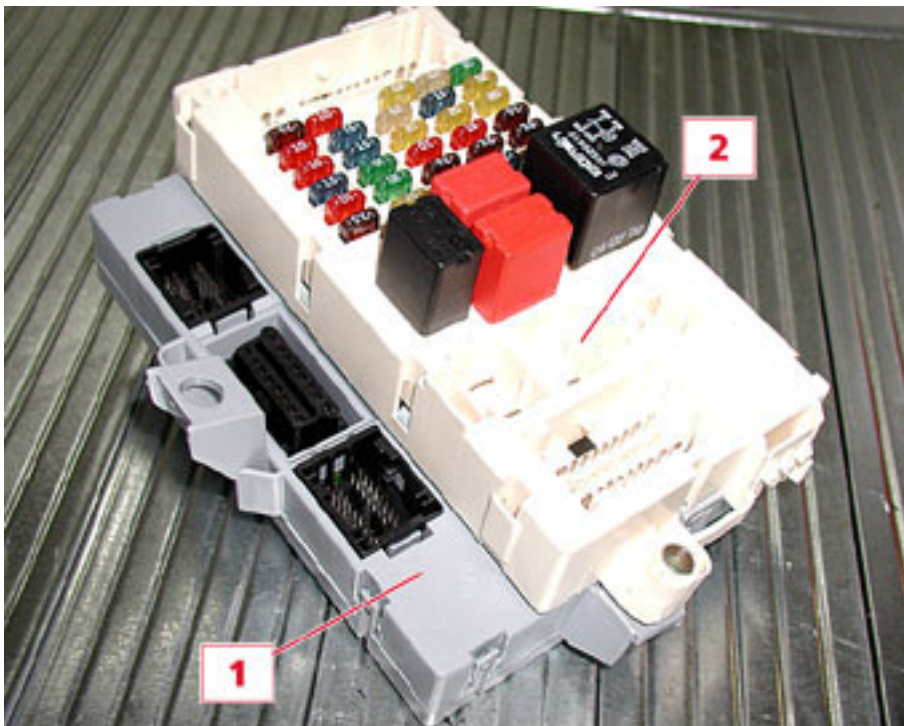

When refitting, follow the above procedures in reverse order

- After connecting the battery's negative terminal, the following self-learning operations must be carried out to ensure that certain connected devices acknowledge the system again:
- Refer to section:
Component self-learning in the event of battery disconnection

N.B.

In the event of replacement of the Body Computer node, it is not necessary to run the "proxy" procedure as the new component is supplied by the Spare Parts department ready for connection to the CAN network and to dialogue correctly with the ECUs installed in the vehicle.

DASHBOARD NODE (NPL)

Removing - refitting the dashboard node (NPL)

- The dashboard node (NPL) is composed of the Body Computer node and dashboard ECU assembly, therefore to remove or replace it, follow the procedure shown for removing-refitting the Body Computer node without taking the two components apart.

Body computer node

- In the event of replacement of the dashboard node, the "Proxy" procedure must be carried out to ensure the new NPL recognises the components connected to the CAN network and begins to dialogue with them.
- Connect the SD3 tester (**95970312**) to the diagnostics socket and run the "Proxy" procedure.

HEADLIGHT SET-UP ECU (CAF)

Removing-refitting the headlight set-up ECU (CAF)

- Move the front seat on the driver's side as far back as possible
- Disconnect the battery's negative terminal.
- Remove the protective cover on the suspension control node compartment.



- Undo the fastening screw, detach the electric connection and move the suspension control node out the compartment.

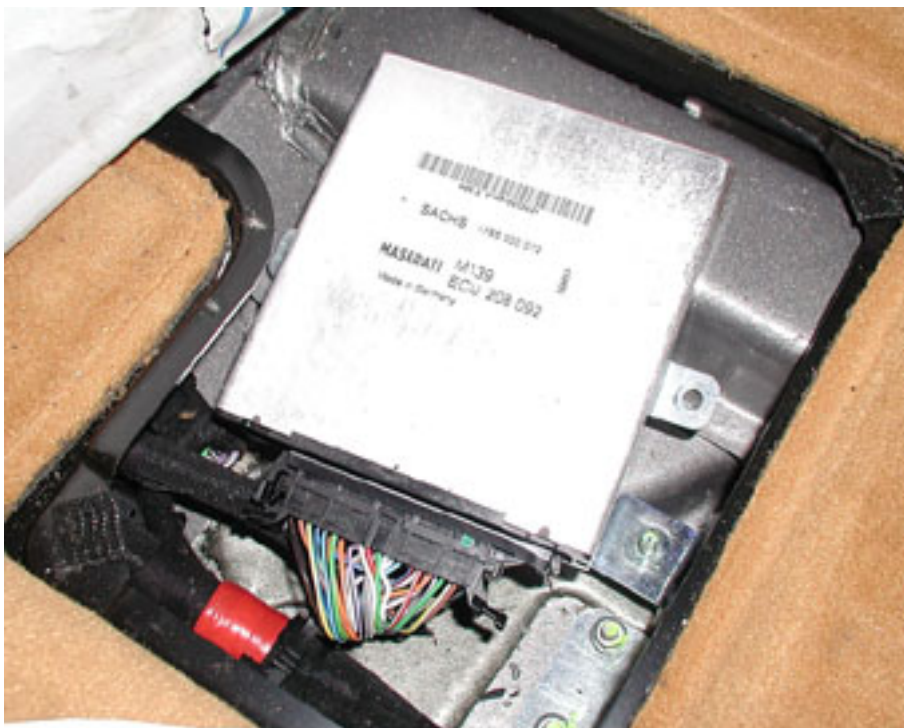

- Unscrew the fastening nuts on the mounting bracket.



- Pull out the bracket, unscrew the fastening nuts, detach the electric connection and remove the headlight set-up ECU (CAF).



When refitting, follow the above procedures in reverse order

- After connecting the battery's negative terminal, the following self-learning operations must be carried out to ensure that certain connected devices acknowledge the system again:
- Refer to section:

Component self-learning in the event of battery disconnection

SUSPENSION CONTROL NODE (NCS)

Removing-refitting the suspension control node (NCS)

- Move the front seat on the driver's side as far back as possible
- Disconnect the battery's negative terminal.
- Remove the protective cover on the suspension control node compartment.



- Undo the fastening screw, detach the electric connection and remove the suspension control node from the relative compartment.



When refitting, follow the above procedures in reverse order

- After connecting the battery's negative terminal the following self-learning operations must be carried out to ensure that certain connected devices acknowledge the system again:
- Refer to section:

Component self-learning in the event of battery disconnection

ELECTRONICALLY-CONTROLLED GEARBOX NODE (NCR)

Removing-refitting the electronically-controlled gearbox node (NCR)

- The removal and refitting of the electronically-controlled gearbox node is outlined in the section "Transmission devices - electronically-controlled gearbox controls" in the chapter headed "Electronically-controlled gearbox control unit (TCU)".

Replacing the electronically-controlled gearbox control unit (TCU)

ENGINE CONTROL NODE (NCM)

Removing-refitting the engine control node (NCM)

- Disconnect the battery's negative terminal.
- Move the front seat on the passenger side as far back as possible.
- Remove the protective cover on the engine control node compartment.



- Undo the fastening screw on the bracket, detach the two electric connections and remove the engine control node from the relative compartment.



When refitting, follow the above procedures in reverse order

- After connecting the battery's negative terminal the following self-learning operations must be carried out to ensure that certain connected devices acknowledge the system again:
- Refer to section:

Component self-learning in the event of battery disconnection

BRAKE SYSTEM NODE (NFR)

Removing-refitting the brake system node (NFR)

- The removal and refitting of the brake system node is outlined in the section "Brakes - Electro-hydraulic and hydraulic control unit" in the chapter headed "ABS . – A.S.R.-- E.B.D. – E.S.P. electro-hydraulic control unit".

A.B.S- A.S.R.-- E.B.D. - E.S.P electro-hydraulic control unit.

STEERING ANGLE NODE (NAS)

Removing-refitting the steering angle node (NAS)

- Remove the steering column stalk from the steering column.
Steering column stalk and electronically-controlled gearbox levers
- With the steering column stalk on the bench, undo the two fastening screws and remove the steering angle node.

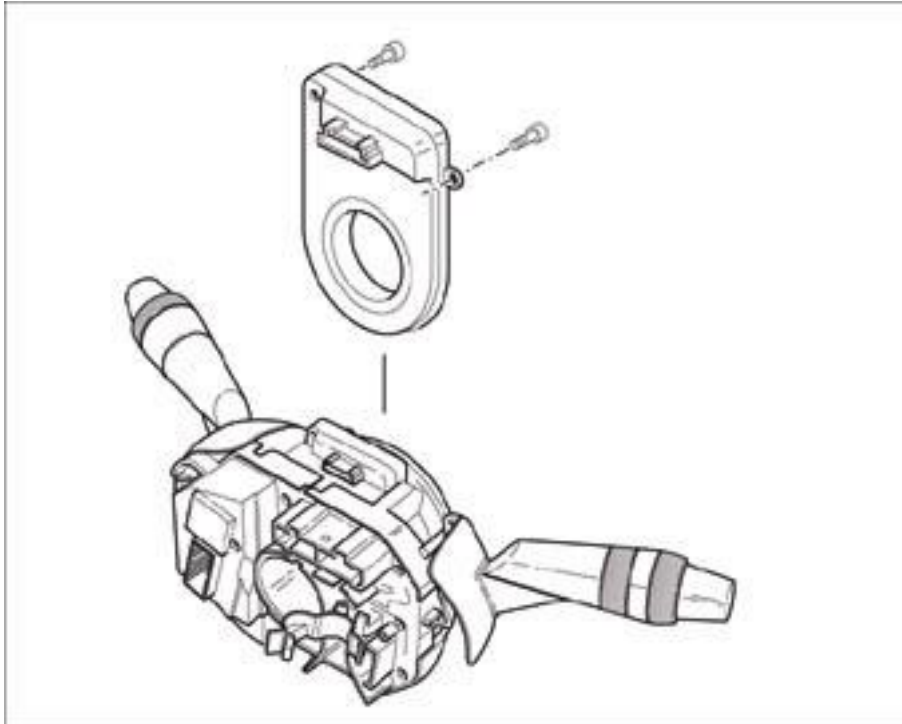

PARKING SENSOR NODE (NSP)

Removing – refitting the parking sensor node (NSP)

- Remove the LH trim panel in the luggage compartment
Compartment trim panels
- Unscrew the fastening nuts on the ECU and digital stereo system amplifier holder bracket.



- Unscrew the nut, disconnect the electrical connections, then remove the parking sensor node (NSP).



When refitting, follow the above procedures in reverse order

- After connecting the battery's negative terminal the following self-learning operations must be carried out to ensure that certain connected devices acknowledge the system again:
- Refer to section:

Component self-learning in the event of battery disconnection

POWER STEERING ECU (CSG)

Removing-refitting the power steering ECU (CSG)

- Disconnect the battery's negative terminal.
- Undo the fastening screws on the footrest covering.



- Lever the lower part of the weather strip out the driver's door bay.
- Remove the screw covering plug on the engine lid opening lever.



- Unscrew the fastening nut on the engine lid opening lever.



- Pull the lever out of the threaded pin without disconnecting the opening cable.



- Remove the corner trim panel.



- When removing the corner trim panel from the door, take care not to damage the plastic fastening pins on the trim panel itself.



- Undo the two fastening screws and remove the footrest covering.



- Unscrew the three fastening screws and extract the ECUs' mounting bracket .



- Unscrew the nuts, detach the electric connection and remove the power steering ECU (CSG).



When refitting, follow the above procedures in reverse order

- After connecting the battery's negative terminal the following self-learning operations must be carried out to ensure that certain connected devices acknowledge the system again:
- Refer to section:

Component self-learning in the event of battery disconnection

AIRBAG NODE (NAB)

Removing-refitting the Airbag node (NAB)

- The removal and refitting of the Airbag node is outlined in the section "Steering Airbag - Airbag /sidebag system with electrically-controlled pretensioners" in the chapter headed " Airbag and sidebag ECU".

Airbag and sidebag ECU

LUGGAGE COMPARTMENT NODE (NVB)

Removing-refitting the luggage compartment node (NVB)

- Disconnect the battery's negative terminal.
- Remove the rear parcel shelf

Removing-refitting the rear parcel shelf

- Detach the electrical connections, unscrew the 4 fastening nuts and remove the luggage compartment node (NVB).

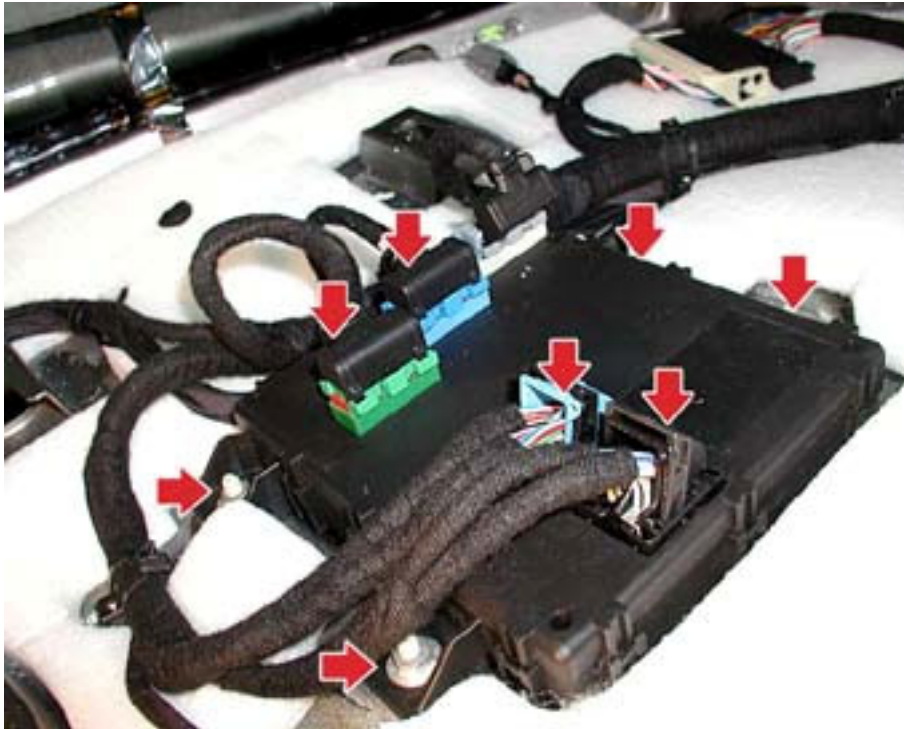

When refitting, follow the above procedures in reverse order

- After connecting the battery's negative terminal the following self-learning operations must be carried out to ensure that certain connected devices acknowledge the system again:
- Refer to section:

Component self-learning in the event of battery disconnection

AIR CONDITIONING AND HEATING SYSTEM NODE (NCL)

Removing-refitting the air conditioning and heating system node (NCL)

- The removal and refitting of the air conditioning and heating system node (NCL) is outlined in the section "Air conditioning/heating system - Replacing the components" in the chapter headed "Air conditioning/heating system ECU".

Air conditioning/heating system ECU

DRIVER POSITION NODE (NAG)

Removing-refitting the driver position node (NAG)

- Remove the front seat concerned from the vehicle and the relative guards from the front seat.
Front seats
- Disconnect the pneumatic lines from the couplings on the massage and ventilation ECU.

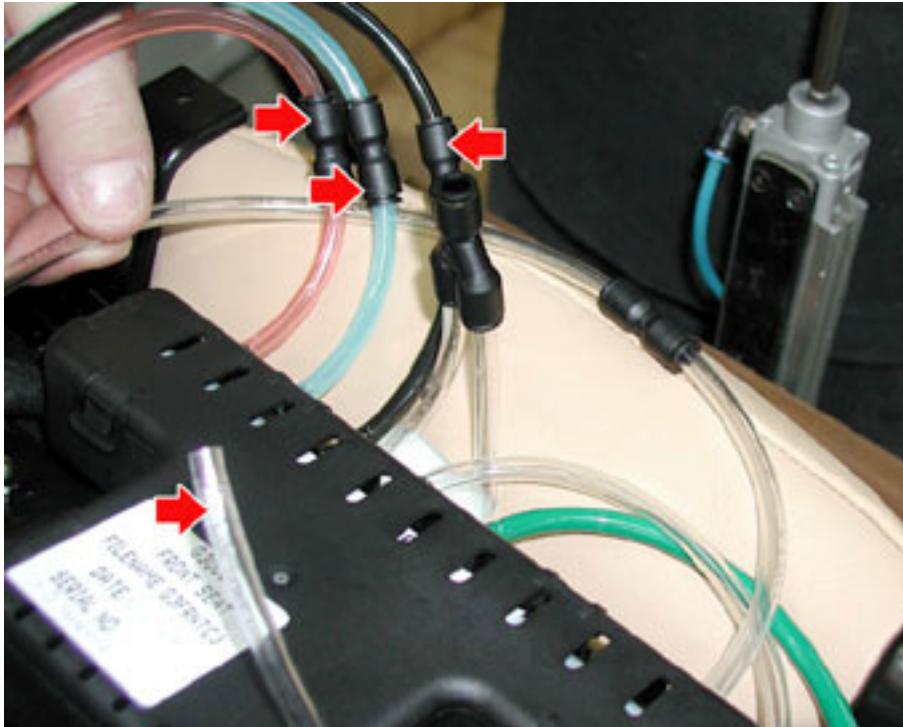

- Disconnect the pneumatic line from the jointing.



- Detach the electric connection.



- Detach the electric connections.

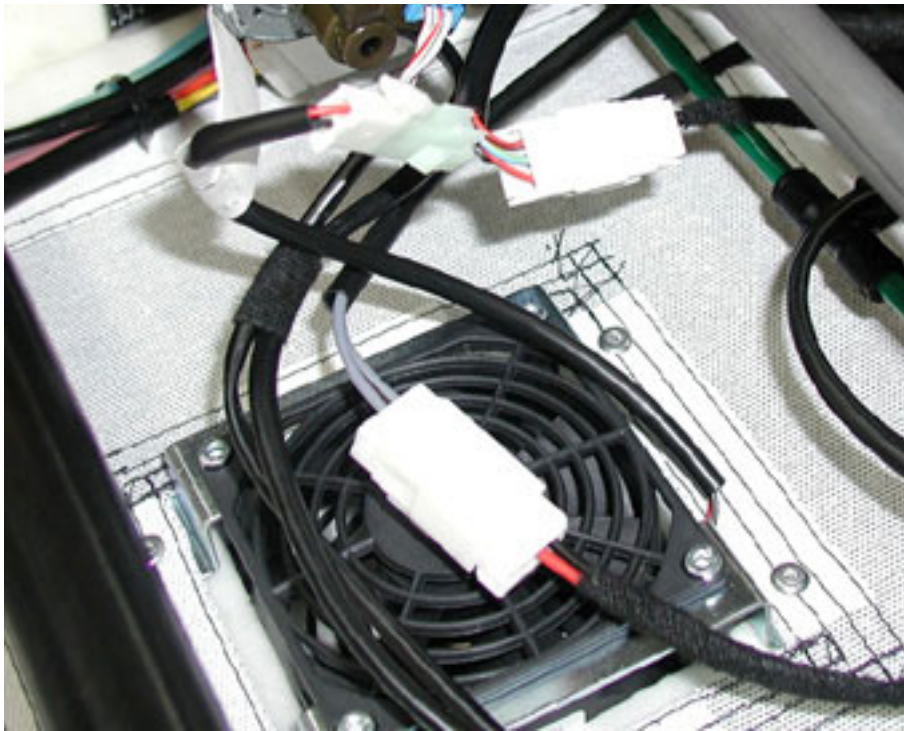

- Undo the two fastening screws and remove the driver position node (NAG) and the pneumatic control unit complete with its bracket.

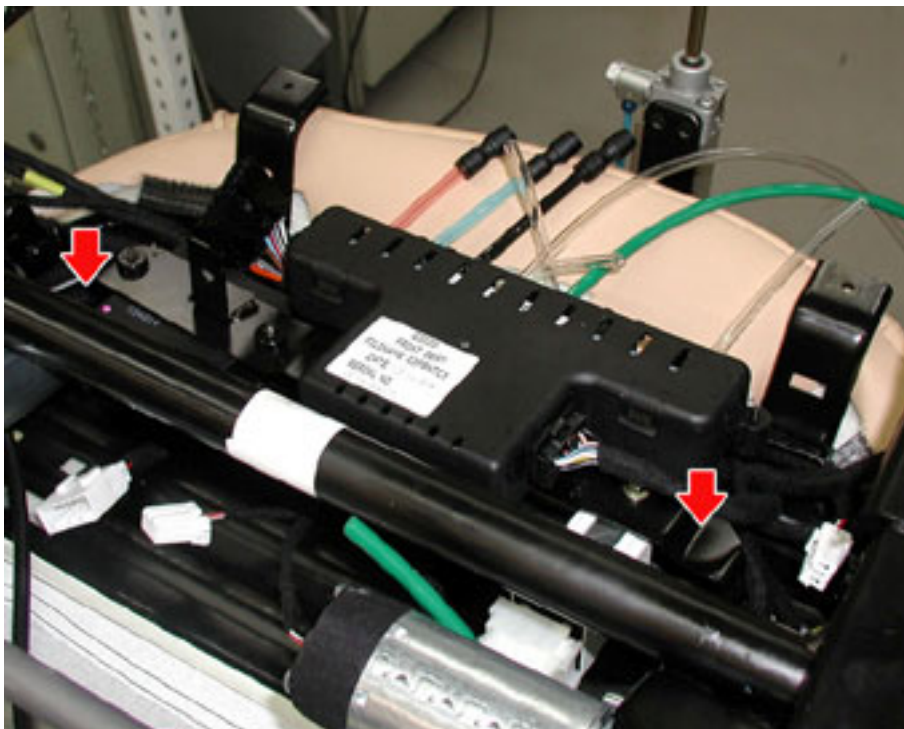

- With the assembly on the bench, separate the driver position node (NAG) from the bracket and from the massage function pneumatic control unit.

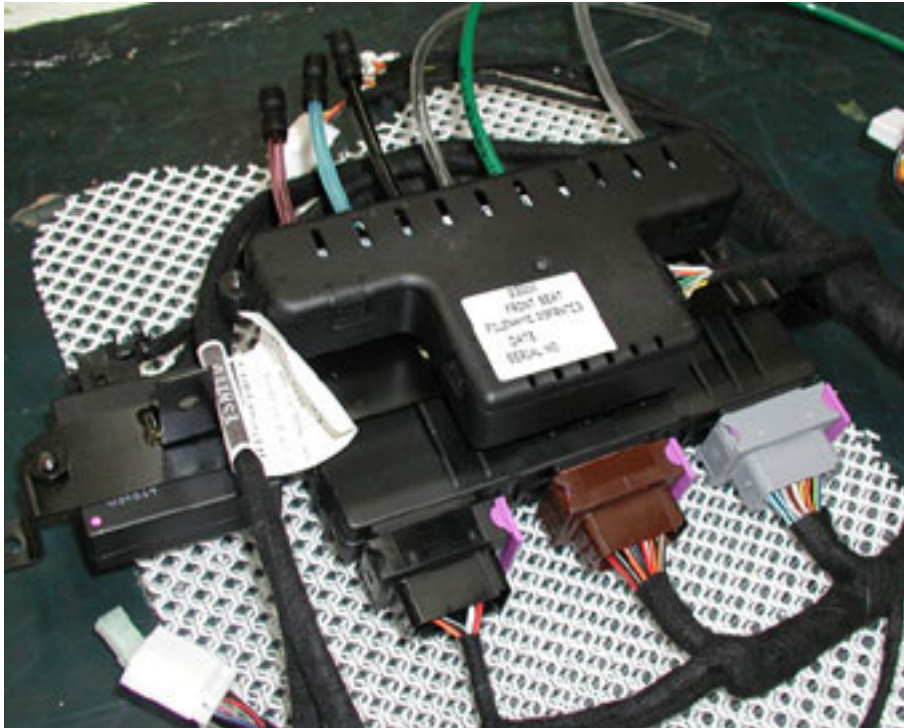

When refitting, follow the above procedures in reverse order

- After connecting the battery's negative terminal the following self-learning operations must be carried out to ensure that certain connected devices acknowledge the system again:
- Refer to section:

Component self-learning in the event of battery disconnection

DRIVER'S DOOR NODE (NPG)

Removing-refitting the driver's door node (NPG)

- The removal and refitting of the driver's door node is outlined in the section "Bodywork - Interiors" in the chapter headed "Front power window control button/ECU".

Front power window control button/ECU

PASSENGER'S DOOR NODE (NPP)

Removing-refitting the passenger's door node (NPP)

- The removal and refitting of the passenger's door node (NPP) is identical to the procedure followed when removing the driver's door node (NPG).

Front power window control button/ECU

INTERNAL ROOF PANEL NODE (NIM)

Removing-refitting the internal roof node (NIM)

- Disconnect the battery's negative terminal.
- Undo the fastening screws and remove the side guard.



- Remove the corner guard from the floor trim panel.



- Lift and tilt the floor trim panel and the soundproofing material on the floor area.



- Undo the fastening screw, detach the electrical connections and remove the internal roof node NIM from the seat.

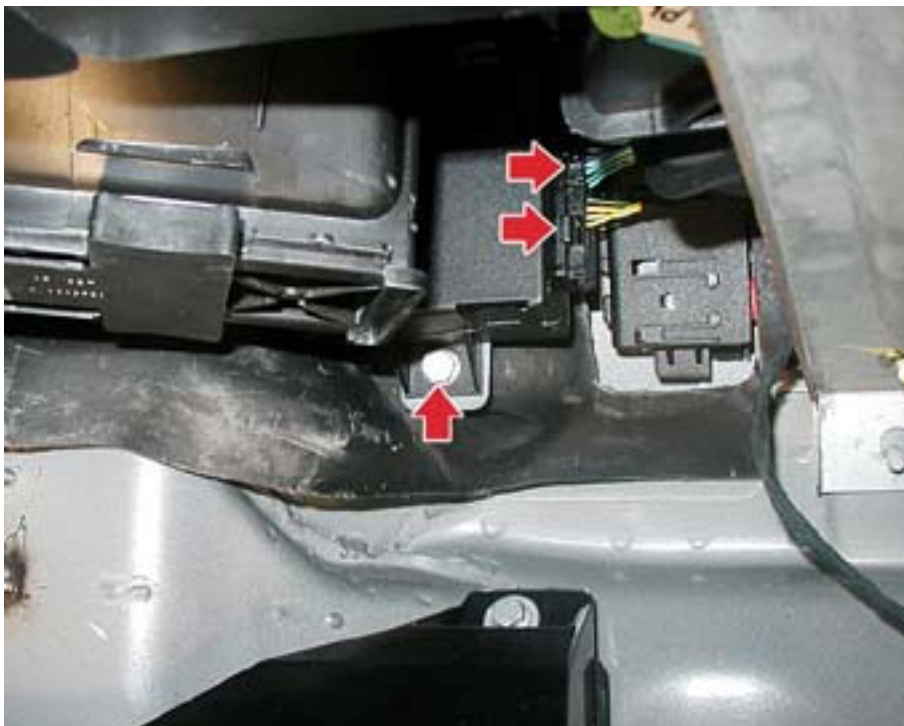

When refitting, follow the above procedures in reverse order

- After connecting the battery's negative terminal, the following self-learning operations must be carried out to ensure that certain connected devices acknowledge the system again:

- Refer to section:

Component self-learning in the event of battery disconnection

- In the event of replacement of the dashboard node (NIM), the "Proxy" procedure must be carried out to ensure the new component recognises and begins to dialogue with the CAN network.
- Connect the SD3 tester (**95970312**) to the diagnostics socket and run the "Proxy" procedure.

INSTRUMENT PANEL NODE (NQS)

Removing-refitting the instrument panel node (NQS)

- The removal and refitting of the instrument panel node (NQS) is outlined in the section "Bodywork - Interiors" in the chapter headed "Control panel".

Control panel

RAIN/TWILIGHT SENSOR ECU (CSP)

Removing - refitting the rain/twilight sensor ECU (CSP)

- Disconnect the battery's negative terminal.
- Remove the windscreen anti-mist sensor.

Windscreen anti-mist sensor

- Remove the upper snap-fitted plate.



- Lift the internal rear-view mirror until it is released from the joint glued to the windscreen, then remove it.



- Detach the electrical connection, open the fastening clips and remove the rain/ twilight sensor ECU.



When refitting, follow the above procedures in reverse order

- After connecting the battery's negative terminal, the following self-learning operations must be carried out to ensure that certain connected devices acknowledge the system again:
- Refer to section:

Component self-learning in the event of battery disconnection

WINDSCREEN WIPER CONTROL UNIT (CTC)

Removing-refitting the windscreen wiper control unit (CTC)

- Disconnect the battery's negative terminal.
- Undo the fastening screws on the footrest covering panel.



- Lever the lower part of the weather strip out the driver's door bay.
- Remove the screw covering plug on the engine lid opening lever.



- Unscrew the fastening nut on the engine lid opening lever.



- Pull the lever out of the threaded pin without disconnecting the opening cable.



- Remove the corner trim panel.



- When removing the corner trim panel from the door, take care not to damage the plastic fastening pins on the trim panel itself.



- Undo the two fastening screws and remove the footrest covering.



- Unscrew the three fastening screws and extract the ECUs' mounting bracket .

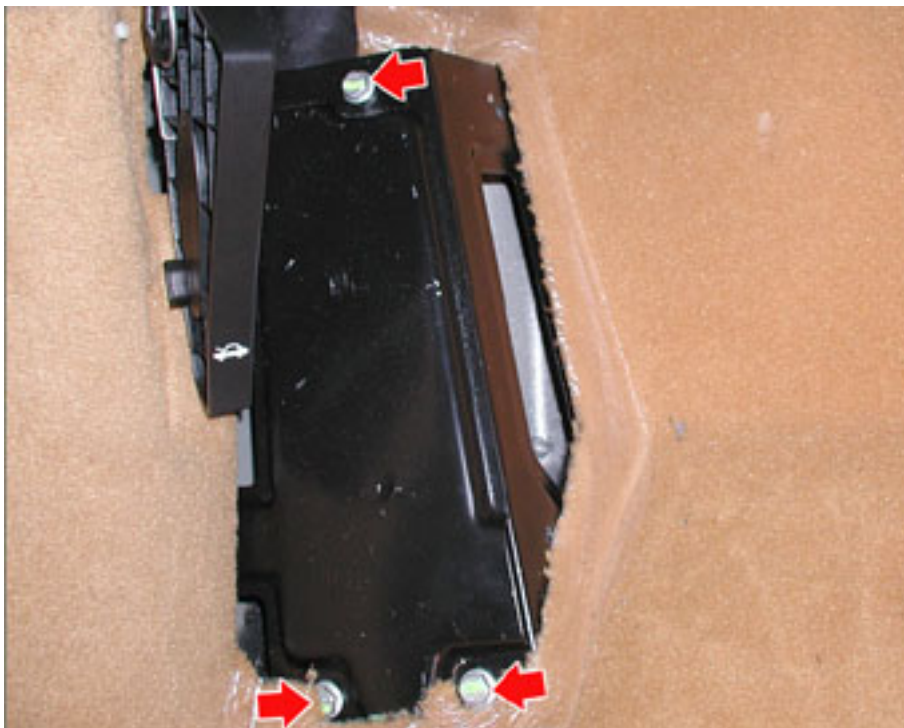

- Unscrew the nuts, detach the electric connection and remove the windscreen wiper control unit (CTC)



When refitting, follow the above procedures in reverse order

- After connecting the battery's negative terminal the following self-learning operations must be carried out to ensure that certain connected devices acknowledge the system again:
- Refer to section:

Component self-learning in the event of battery disconnection

MOTION-SENSING ALARM CONTROL UNIT (CAV)

Removing-refitting the motion-sensing alarm control unit (CAV)

- The removal and refitting of the motion-sensing alarm control unit (CAV) is outlined in the section "Electric-electronic system Appendix" in the chapter headed "Alarm system kit replacement - Removing-refitting the motion sensors".

Alarm system kit replacement

ALARM SYSTEM SIREN CONTROL UNIT (CSA)

Removing-refitting the alarm system siren control unit (CSA)

- The removal and refitting of the alarm system siren control unit (CSA) is outlined in the section "Electric-electronic system Appendix" in the chapter headed "Alarm system kit replacement - Removing-refitting the alarm system siren".

Alarm system kit replacement

TV NODE (NTV)

Removing - refitting the TV node (NTV)

- Remove the upper trim panel in the luggage compartment
Luggage compartment trim panels
- Disconnect the electrical connections on the TV node.



- Unscrew the fastening nuts and lower the robotised gearbox node without disconnecting the electrical connections.

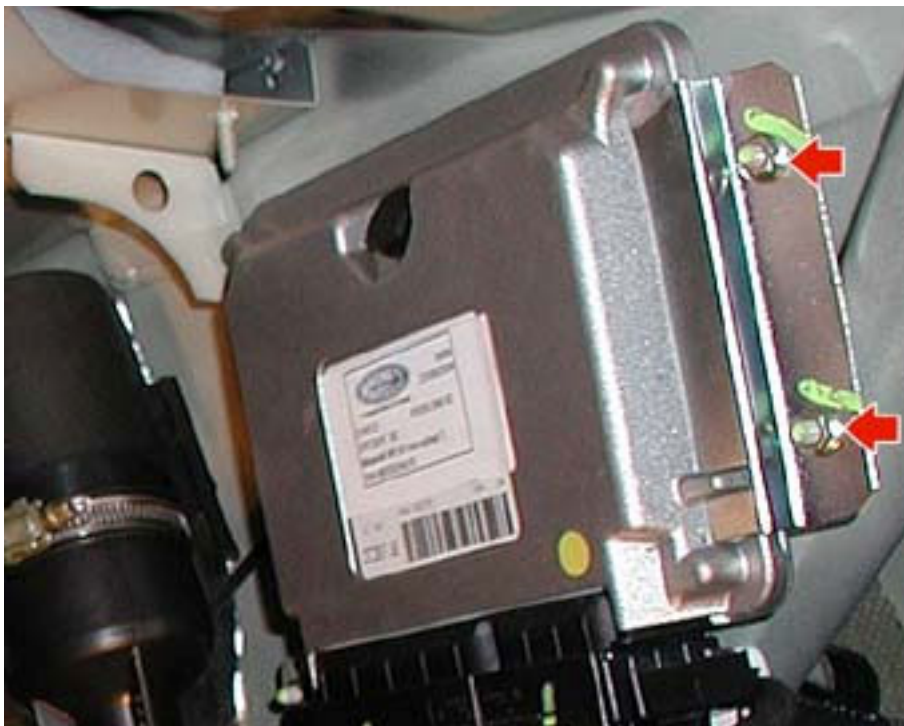

- Unscrew the fastening nuts on the bracket and remove the bracket and TV node assembly.

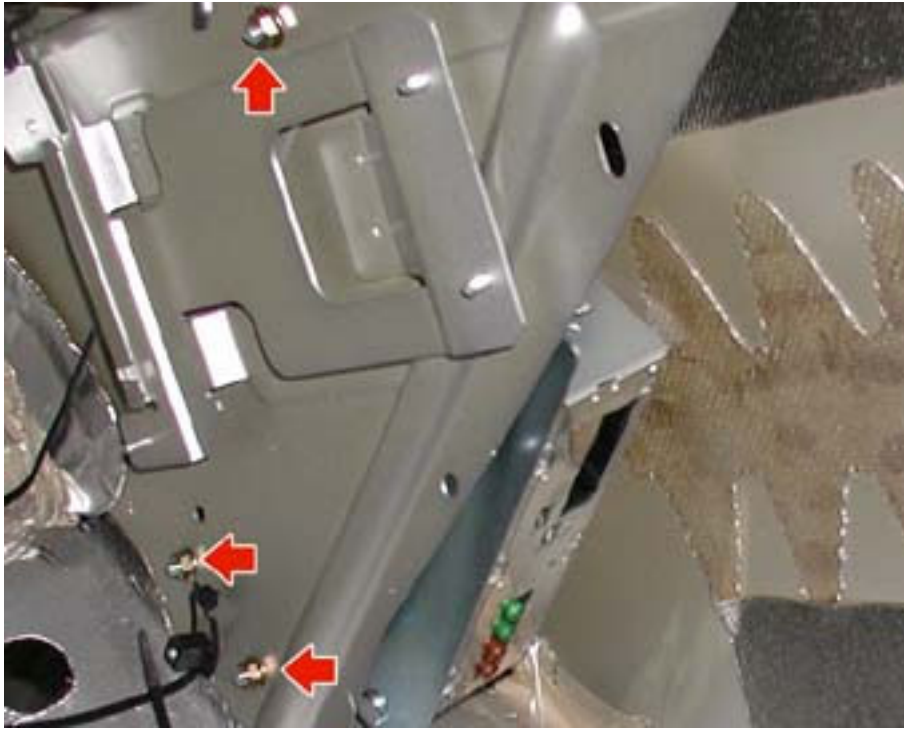

When refitting, follow the above procedures in reverse order

- After connecting the battery's negative terminal the following self-learning operations must be carried out to ensure that certain connected devices acknowledge the system again:
- Refer to section:

Component self-learning in the event of battery disconnection

IT INFO NODE (NIT)

Removing-refitting the IT info node (NIT)

- The removal and refitting of the IT info node (NIT) is outlined in the section " Bodywork - Interiors" in the chapter headed "IT Module".

IT module

TYRE PRESSURE NODE (NTP)

Removing – refitting the tyre pressure node (NTP)

- Move the front seat on the driver's side as far back as possible
- Disconnect the negative terminal of the battery.
- Remove the protective cover on the suspension control node compartment.



- Undo the fastening screw, detach the electric connection and move the suspension control node out the compartment.

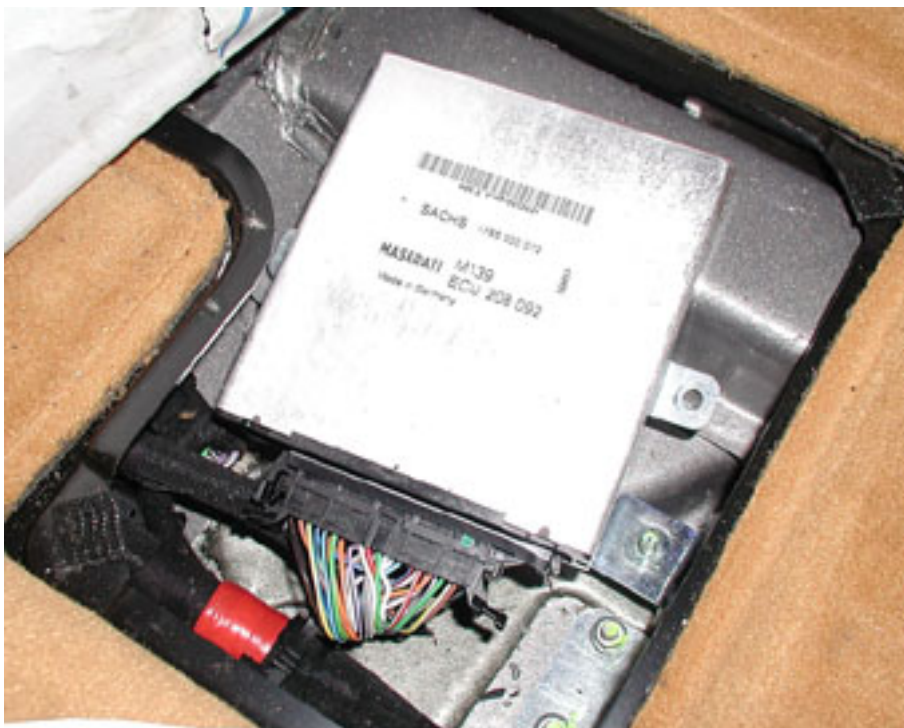

- Unscrew the fastening nuts on the mounting bracket.



- Take out the bracket, unscrew the fastening nuts, detach the electrical connection and remove the tyre pressure node (NTP).



When refitting, follow the above procedures in reverse order

- After connecting the battery's negative terminal the following self-learning operations must be carried out to ensure that certain connected devices acknowledge the system again:
- Refer to section:

Component self-learning in the event of battery disconnection

DASHBOARD CONTROL UNIT (CPL)

Removing-refitting the dashboard control unit (CPL)

- The dashboard control unit (CPL) is secured to the Body Computer node, therefore, to remove or replace it, follow the procedure outlined for removing-refitting the Body Computer node.

CAUTION

As far as the dashboard control unit is concerned, the Proxy and realignment procedures are not necessary.

Body Computer node