

Service Training



## Self-Study Programme 334

# The fuel system in FSI engines

Design and function

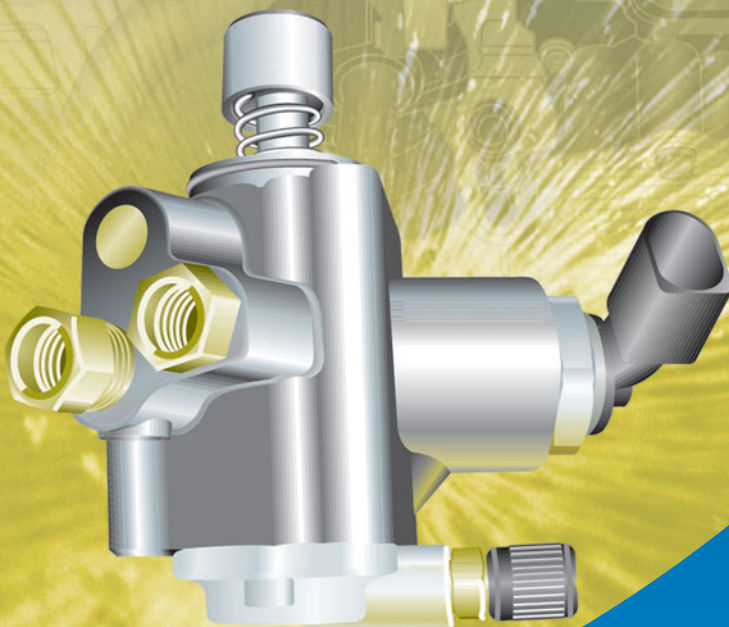

All FSI engines with a power output of over 66 kW are fitted with an improved fuel system.

In this fuel system:

- the high pressure fuel pump and the fuel rail receive a special coating that makes them corrosion resistant to fuels with an ethanol content of up to 10 percent.
- high pressure fuel pump activation has been changed.
- there is no more leakage line on the high pressure fuel pump.
- the pressure limiting valve leakage line on the fuel rail follows the shortest route to the low pressure fuel system upstream of the high pressure fuel pump.

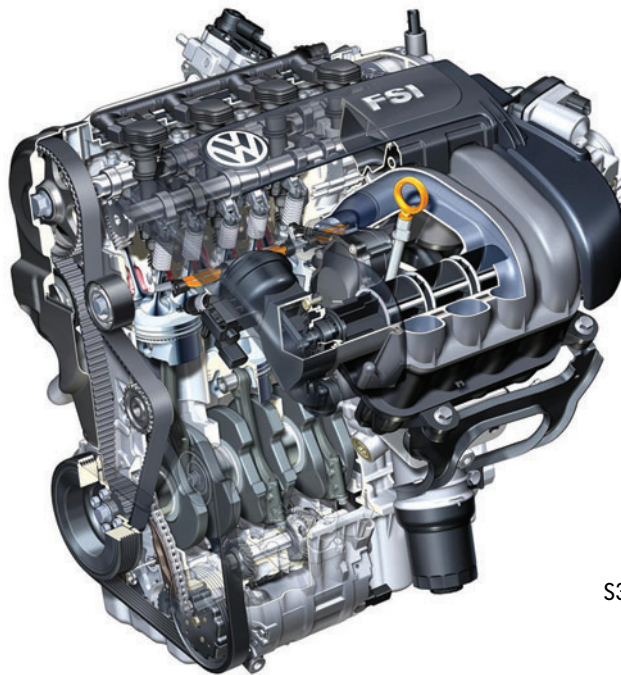

S334\_074

This self-study programme describes the design and function of the improved fuel system using the example of the 2.0 ltr 110 kW FSI engine.

**NEW**





**Important Note**



**This self-study programme shows the design and function of new developments. The contents will not be updated.**

Please always refer to the relevant Service Literature for all inspection, adjustment and repair instructions.



<b>General overview of the fuel system</b> .....	<b>4</b>	
Demand-controlled fuel system .....	4	
<b>Fuel system components</b> .....	<b>6</b>	
Fuel pump control unit .....	6	
Electric fuel pump .....	6	
High pressure fuel pump with fuel pressure regulating valve .....	8	
Fuel pressure sender for lower pressure .....	14	
Fuel pressure sender, high pressure .....	15	
High pressure injectors .....	16	
Pressure limiting valve .....	18	
Connecting piece with restrictor .....	18	
<b>Test your knowledge</b> .....	<b>19</b>	

# General overview of the fuel system



## Demand-controlled fuel system

The demand-controlled fuel system consists of a low pressure and a high pressure fuel system.

It has the advantage that both the electric fuel pump and the high pressure fuel pump convey only as much fuel as the engine needs at a particular time. This reduces the electrical and mechanical drive power of the fuel pump and saves fuel.

## Low pressure fuel system

The low pressure fuel system has a fuel pressure in normal mode ranging from 0.5 to 5 bar.

The pressure is raised to 6.5 bar for hot and cold starts.

This pressure increase produces a higher initial pressure in the high pressure fuel system for cold starts. It achieves better mixture preparation and a quicker start.

The pressure increase also prevents the formation of vapour bubbles in the high pressure fuel pump for hot starts.

### It consists of:

- Fuel pump control unit J538
- Fuel tank
- Electric fuel pump G6
- Fuel filter with pressure limiting valve (opens at approx. 6.8 bar)
- Fuel pressure sender for lower pressure G410

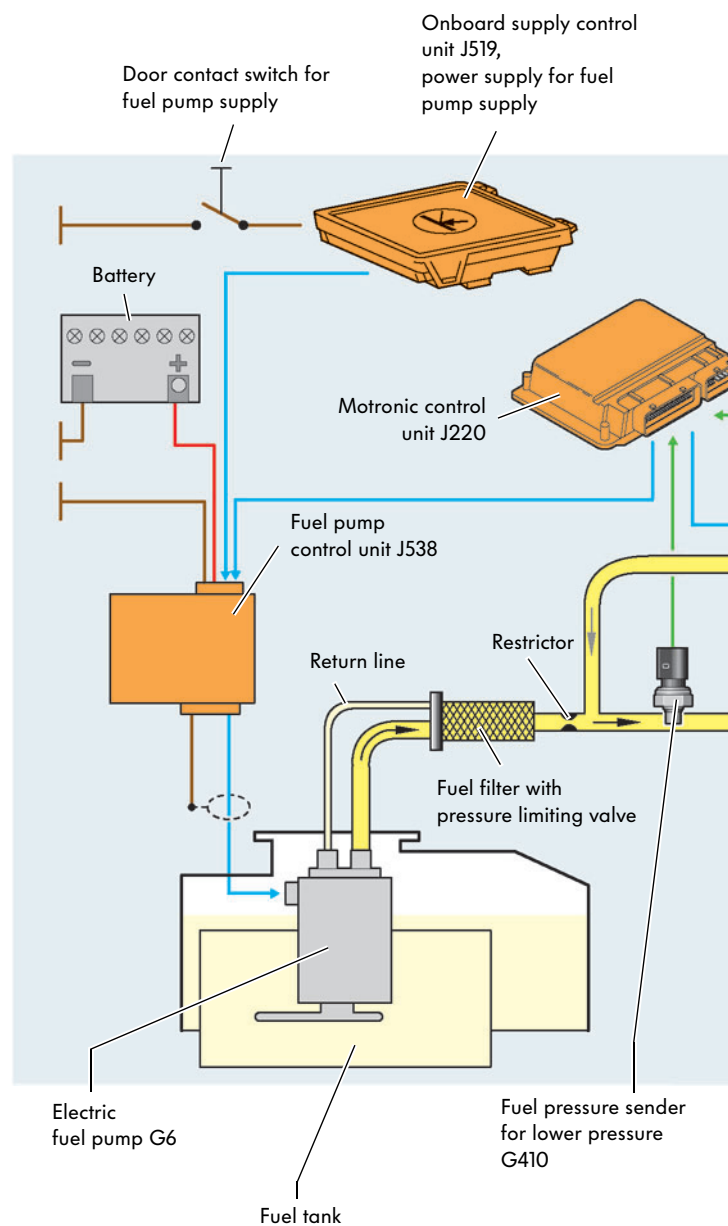

### Colour codes/Legend

	No pressure		Low pressure fuel system
	Low pressure		High pressure fuel system
	High pressure		



## High pressure fuel system

The fuel pressure in the high pressure fuel system ranges from 30 to 110 bar. The pressure range may vary from engine to engine.



**Important:** Be careful when opening the high pressure fuel system. Please observe the instructions in the workshop manuals.

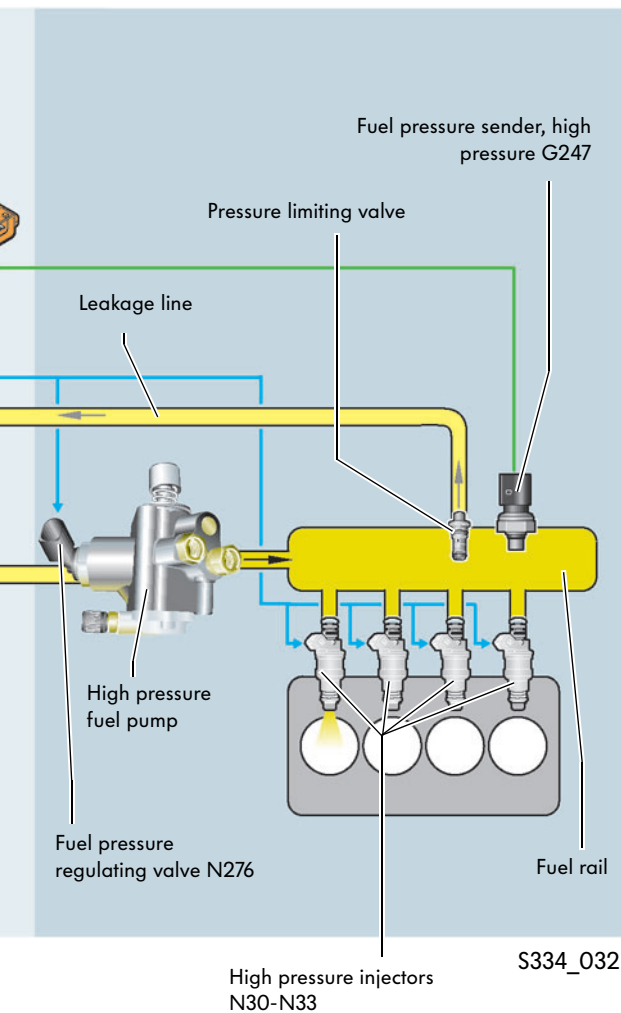

### It consists of:

- High pressure fuel pump  
(corrosion resistant to fuels with an ethanol content of 10%)
- Fuel pressure regulating valve N276
- Fuel rail  
(corrosion resistant to fuels with an ethanol content of 10%)
- Pressure limiting valve  
(opens at approx. 120 bar)
- Fuel pressure sender, high pressure G247
- High pressure injectors N30-N33

# Fuel system components

## Fuel pump control unit J538

The control unit is fitted in the cover of the electric fuel pump.

### Function

The fuel pump control unit controls the electric fuel pump by means of a PWM signal (pulse-width modulated). It regulates pressure in the low pressure fuel system from 0.5 to 5 bar.

The pressure is raised to 6.5 bar for hot and cold starts.

### Failure strategies

If the fuel pump control unit fails, the engine will not run.

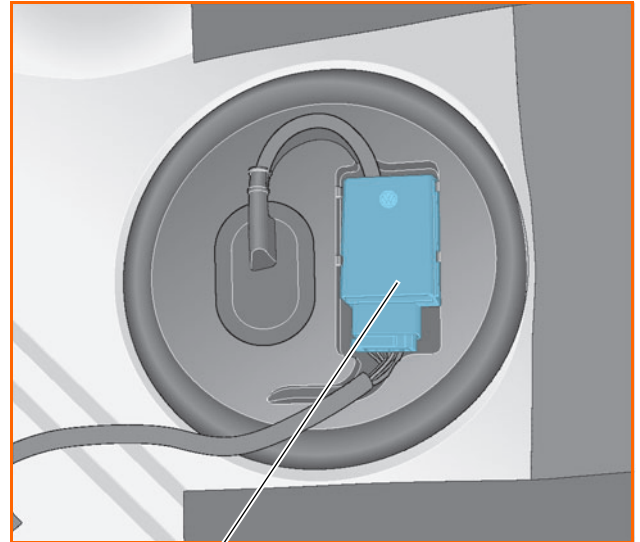

Fuel pump control unit J538

S334\_024

## Electric fuel pump G6

The electric fuel pump is screwed into the fuel tank. It is combined with the fuel gauge sender to form a single component.

### Function

The electric fuel pump conveys fuel through the low pressure fuel system to the high pressure fuel pump. It is activated by a PWM signal sent by the fuel pump control unit.



S334\_076

## How it works

The electric fuel pump always conveys as much fuel as the engine requires at a particular time.

The momentary fuel pressure is measured by the fuel pressure sender for lower pressure and sent to the engine control unit. If this pressure deviates from the reference pressure, the engine control unit sends an appropriate PWM signal (frequency 20 Hz) to the fuel pump control unit. The control unit sends a PWM control signal (frequency 20 kHz) to the electric fuel pump until the fuel pressure returns to the map curves.

Advantages:

- Lower power consumption since the fuel pump only conveys as much fuel as the engine requires at a particular moment.
- Less heat entrained in the fuel since only as much fuel is compressed as is required at a particular moment.
- Reduced noise, especially in idling mode.



## Low pressure fuel system

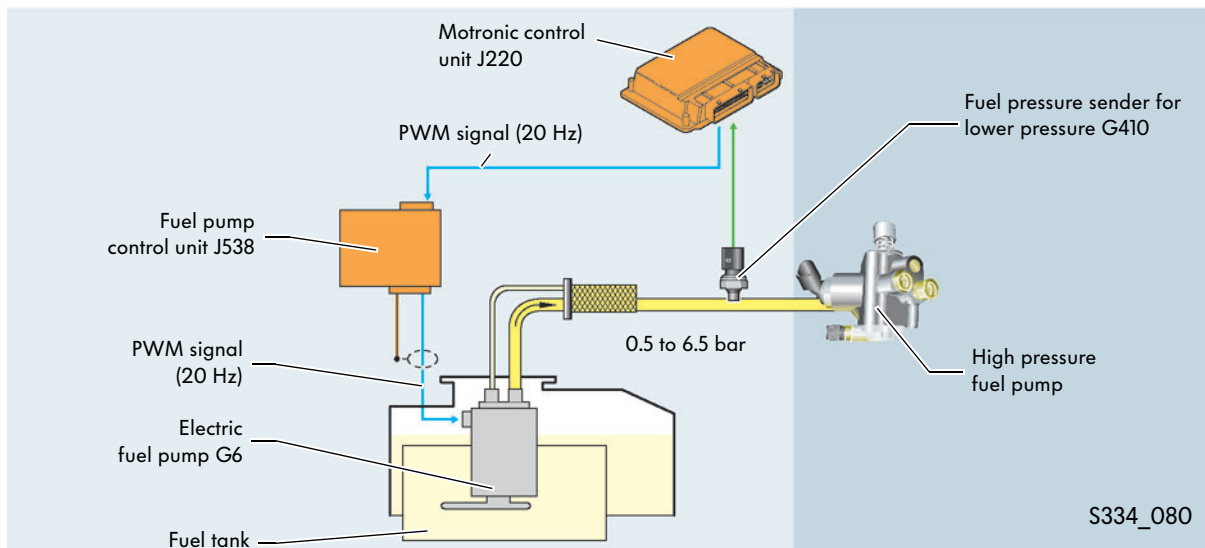

## Failure strategies

If the electric fuel pump fails, the engine will not run.



If the engine control unit or the fuel pump control unit is renewed, adaption of the new parts must be carried out. To do this, refer to the messages displayed during "Guided fault finding" on the VAS 5051.

# Fuel system components

## High pressure fuel pump with fuel pressure regulating valve N276

The high pressure fuel pump is bolted to the cylinder head. Its function is to build up fuel pressure in the high pressure fuel system to a level between 30 and 110 bar.



### Special features

- It is a volume-controlled single-cylinder high pressure fuel pump. As it is map-controlled, it pumps only as much fuel into the fuel rail as is required for fuel injection. This reduces the drive output of the high pressure fuel pump and saves fuel.
- It is corrosion resistant to fuels with an ethanol content of 10 percent. As a result, FSI engines can be offered on the world-wide market.
- There is no more leakage line on the high pressure fuel pump. Excess fuel flows back to the low pressure side of the supply line.

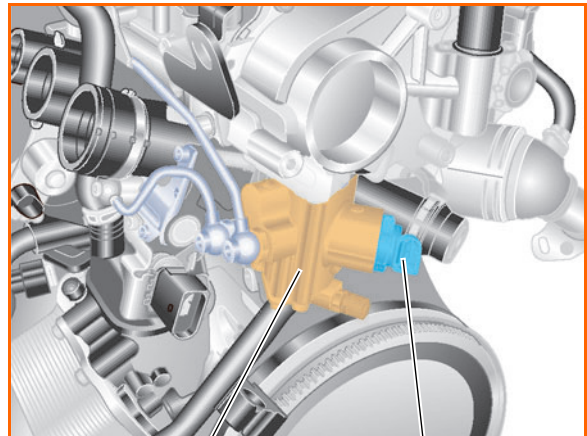

S334\_018

High pressure fuel pump

Fuel pressure regulating valve N276

### High pressure fuel pump drive

The high pressure fuel pump is driven by a double cam on the intake camshaft.



The fitting location, drive and external construction of the high pressure fuel pump depend on the engine type.

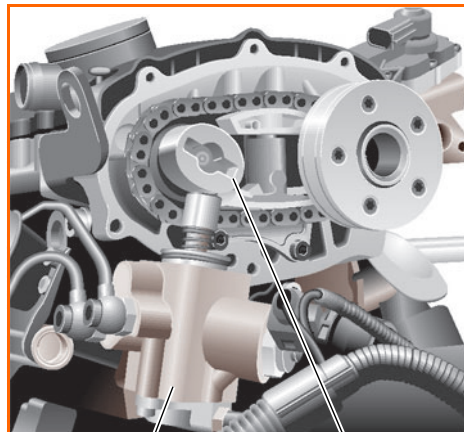

S334\_068

High pressure fuel pump

Double cam



## High pressure fuel pump variants

The high pressure fuel pumps for the various engine series are identical in function and internal construction. However, the external construction may vary due to the construction space available in each case. These differences will be explained below.

### 1.4 ltr 66 kW and 1.6 ltr 85 kW

In this fuel pump, the high pressure fuel line is made of metal and the low pressure fuel line of rubber. The metal line is bolted and the rubber line is secured by a spring band clamp with high prestress. The fuel system is vented during vehicle operation.

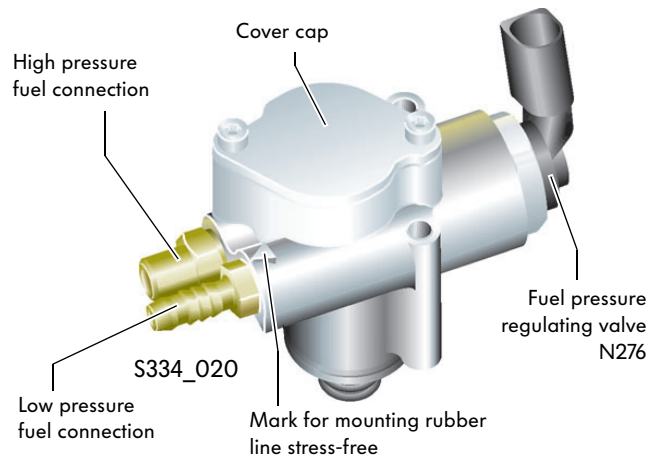

A triangle is located on the rubber line and on the high pressure fuel pump to mount the rubber line stress-free. The apexes of the triangles must be aligned when mounting.

### 2.0 ltr 110 kW and 2.0 ltr 147 kW

In the fuel pump the two fuel lines are made of metal and bolted. The cover cap contains a vent valve that is only required in production. The fuel system vents itself during vehicle operation via the injectors.

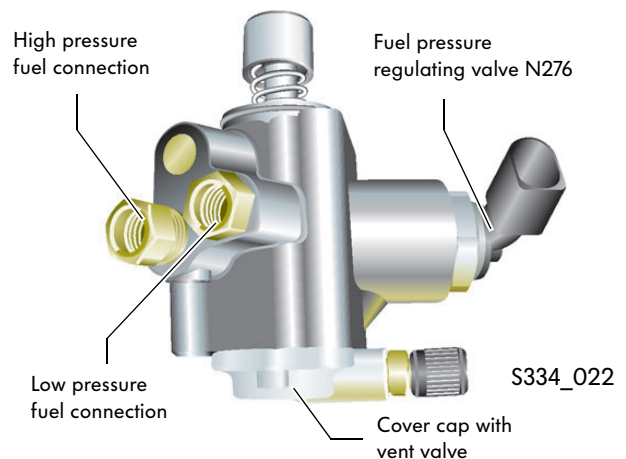

The high pressure fuel pump may not be dismantled. Otherwise it will leak when it is re-assembled.



# Fuel system components

## Activation concept

It is a volume-controlled single-cylinder high pressure fuel pump. As it is map-controlled, it pumps only as much fuel into the fuel rail as is required for fuel injection.

The engine control unit therefore calculates the start of the delivery stroke from the required injection quantity.

When the point in time is reached, the fuel pressure regulating valve closes the inlet valve and the delivery stroke starts.

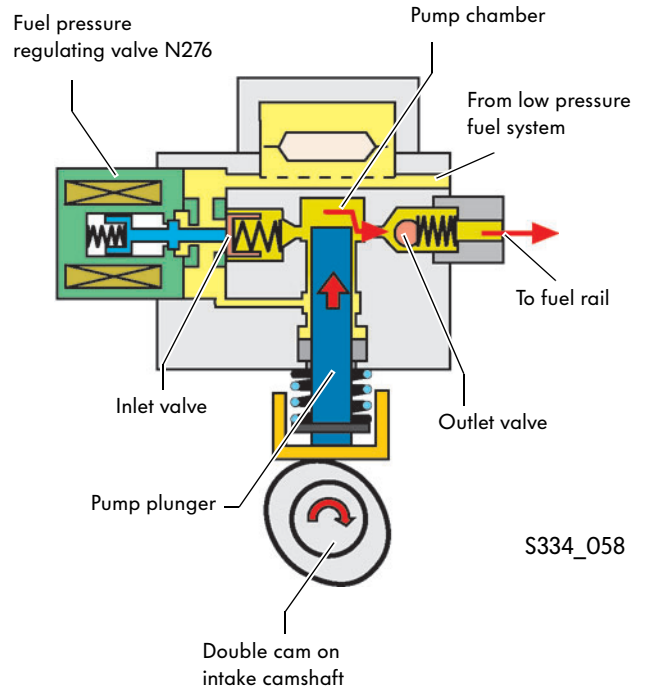

S334\_058

Below the block diagram is a chart divided into three parts. These represent the intake stroke, return stroke and delivery stroke.

The appropriate section is greyed in each of the explanations.

- The blue line indicates the rising curve of the cam, representing a rising or falling movement of the pump plunger.
- The red line indicates the momentary pressure in the pump chamber.

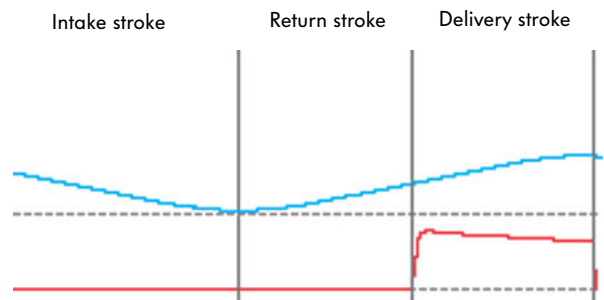

S334\_070

## Fuel intake stroke

During the intake stroke, the inlet valve is opened by the needle valve by the force of the valve needle spring.

Fuel is drawn into the pump chamber for the entire duration of the downwards movement of the pump plunger.

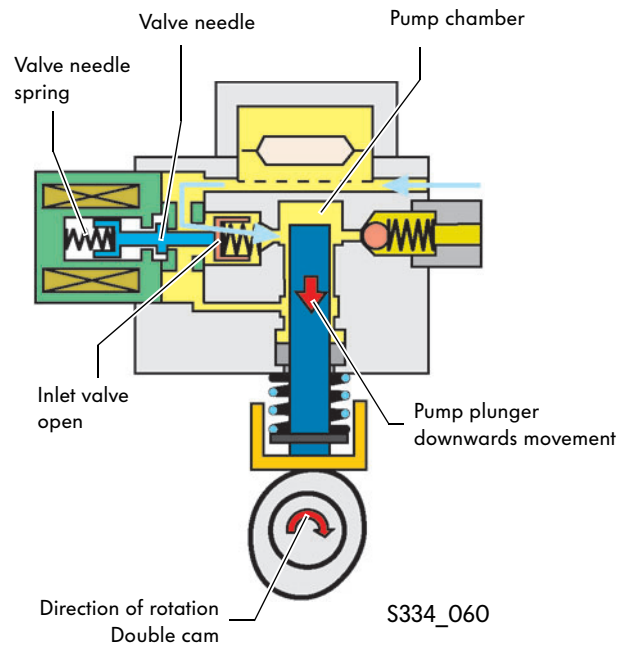

During the intake stroke

- the pump plunger moves down and
- the pressure in the pump chamber roughly corresponds to the pressure in the low pressure fuel system.

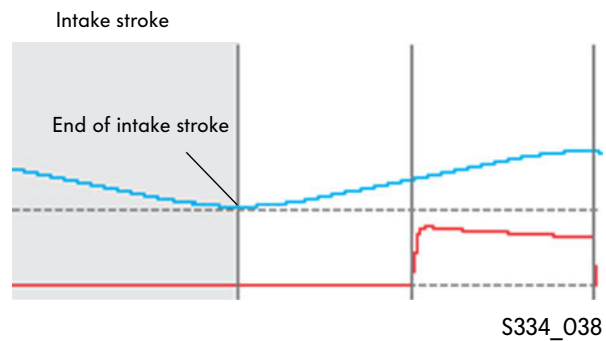

# Fuel system components

## Fuel return stroke

The inlet valve also remains open when the pump plunger starts its upwards movement in order to adjust fuel quantity to actual consumption. The pump plunger presses excess fuel back into the low pressure section.

The resulting pulses are damped by the fuel-pressure attenuator and a restrictor in the fuel supply line.

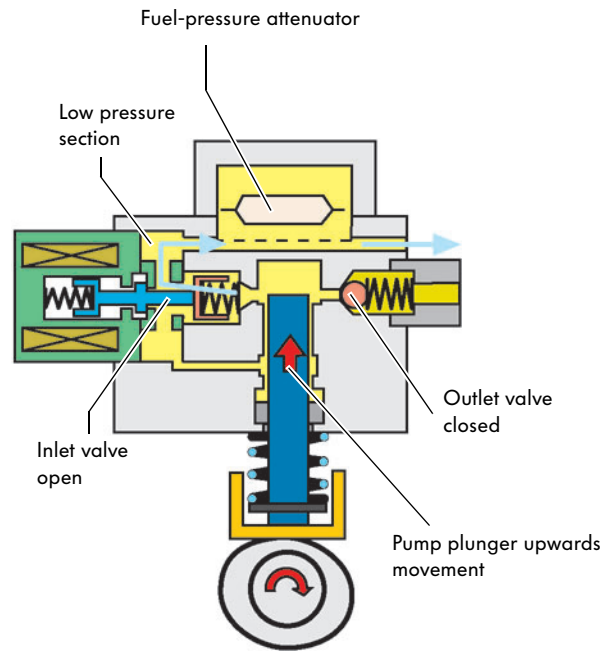

S334\_056

## During the return stroke

- the pump plunger is already on its upwards stroke but
- as the inlet valve is still open, pressure in the pump chamber is still at approximately the same pressure as the low pressure fuel system.

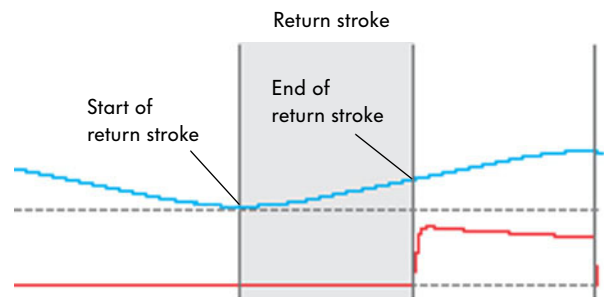

S334\_040

## Fuel delivery stroke

At the calculated start of the delivery stroke, the fuel pressure regulating valve is energised for a short period of time.

This pushes back the valve needle against the force of the valve needle spring and the inlet valve is closed by the force of the inlet valve spring. Pressure is built up in the pump chamber as the pump plunger moves upwards. When pressure in the pump chamber is greater than in the fuel rail, the outlet valve opens. Fuel is pumped to the fuel rail.

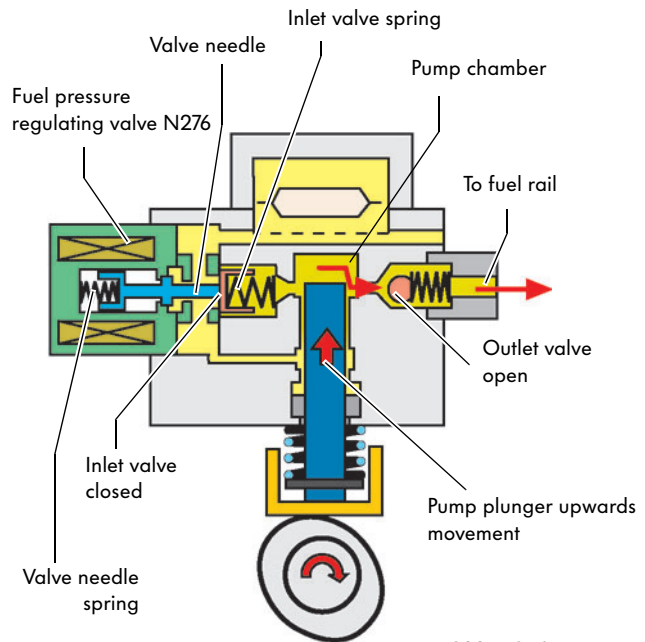

S334\_058

During the delivery stroke

- the pump plunger is still on its upwards stroke and
- pressure in the pump chamber rises. It only starts to fall when the pump plunger reaches its highest point, thus ending the delivery stroke.

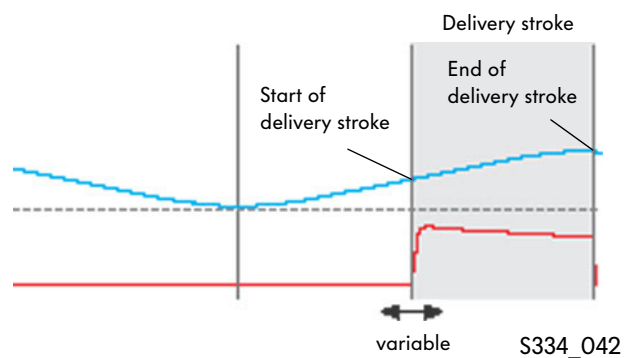

S334\_042

The start of the delivery stroke is variable. It depends on the fuel quantity to be conveyed.



# Fuel system components

## Fuel pressure sender for lower pressure G410

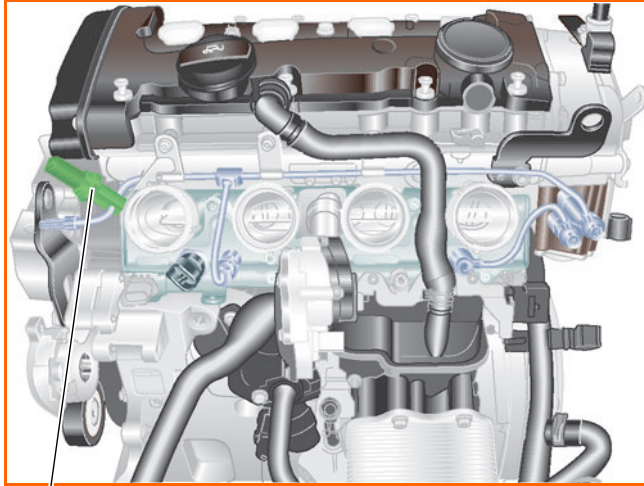

The sender is fitted in the supply line to the high pressure fuel pump. It measures fuel pressure in the low pressure fuel system and sends a signal to the engine control unit.

Fuel pressure sender for lower pressure G410

S334\_012

### Signal utilisation

Use is made of this signal to regulate pressure in the low pressure fuel system.

The fuel pressure may range from 0.5 to 5 bar depending on the engine type.

### Signal failure strategies

If the fuel pressure sender should fail in its function, the electric fuel pump is activated by a fixed PWM signal and pressure in the low pressure fuel system is increased.

## Fuel pressure sender, high pressure G247

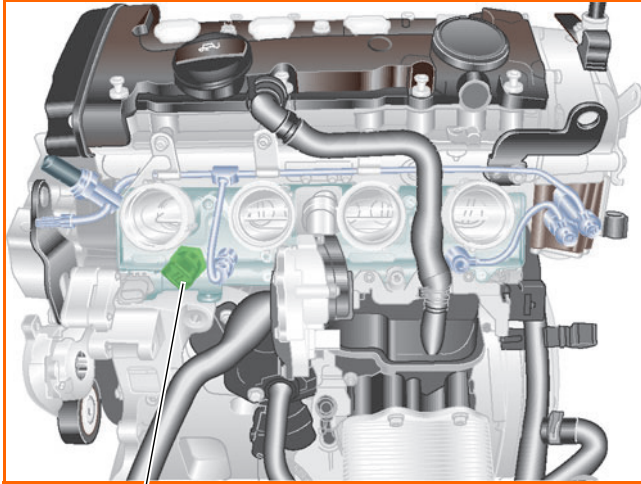

Fuel pressure sender,  
high pressure G247

S334\_014

The sender is located on the lower section of the intake manifold and is screwed into the fuel rail. It measures fuel pressure in the fuel rail and sends a signal to the engine control unit.



### Signal utilisation

The engine control unit evaluates the signal and regulates pressure in the fuel rail via the fuel pressure regulating valve. The fuel pressure may range from between 30 to 110 bar depending on the engine type.

### Signal failure strategies

If the fuel pressure sender should fail in its function, the fuel pressure regulating valve is activated by the engine control unit at a fixed value.

# Fuel system components

## High pressure injectors N30-N33

The high-pressure injectors are inserted in the cylinder head. They inject fuel at high pressure directly into the cylinder.



### Function

The injectors must atomise the fuel completely at high speed and, depending on the operating mode, inject it in a fixed pattern.

In stratified mode, fuel is concentrated around the spark plug, while in homogeneous-lean and homogeneous modes, atomised fuel is distributed evenly throughout the entire combustion chamber.

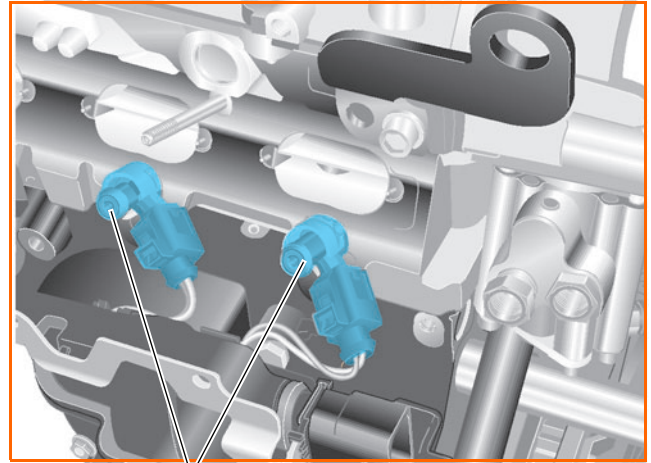

High-pressure injectors

S334\_054

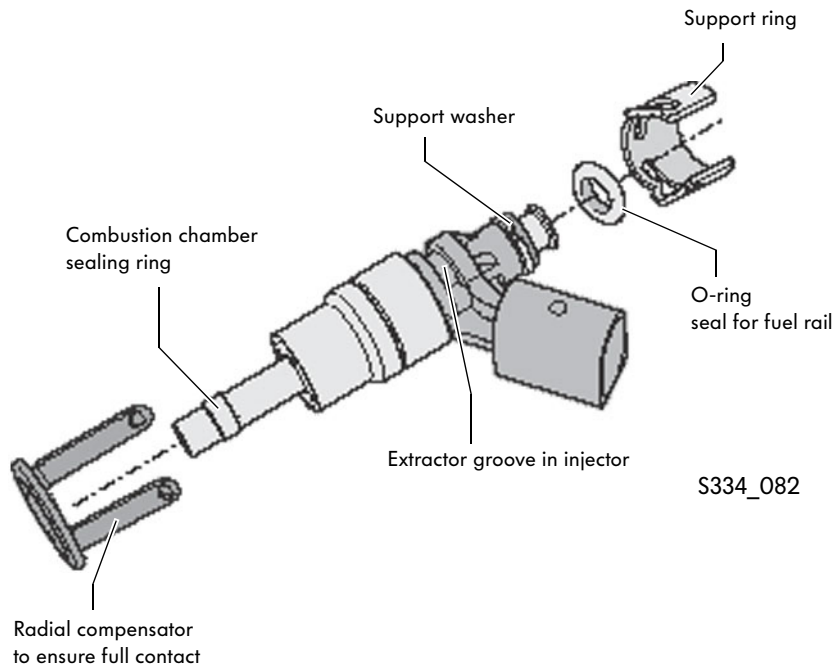

S334\_082



## How it works

During the injection sequence, the solenoid is activated in the injector, thus creating a magnetic field. This energises the solenoid armature with the valve needle, the valve opens and fuel is injected. When coil activation ceases, the magnetic field collapses suddenly and the valve needle is pressed into the valve seat by the compression spring. Fuel flow is interrupted.

## Failure strategies

A defective injector is detected by the misfire detection circuit and is no longer activated.

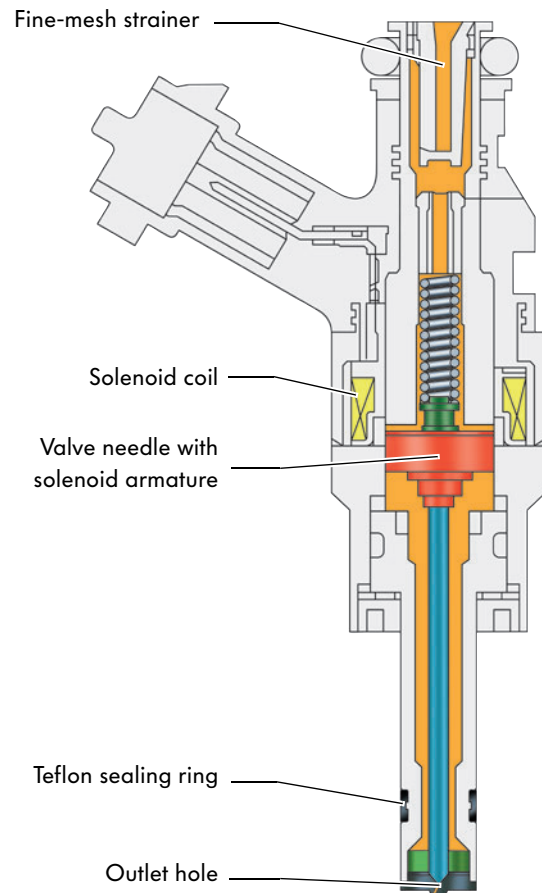

S334\_083



When an injector is renewed, the teach-in values must be erased and the engine control unit must be re-adapted.

Please note the guided fault finding.



# Fuel system components

## Pressure limiting valve

The pressure limiting valve is screwed into the fuel rail and protects the components from heat expansion or malfunctions caused by excessive fuel pressures.

It is a mechanical valve and only opens above a fuel pressure of 120 bar. It releases fuel from the fuel rail via the leakage line to the fuel supply line. There the fuel is immediately pumped back to the high pressure fuel pump.

The short leakage line directly on the engine dispenses with the long leakage line routed through to the fuel tank.

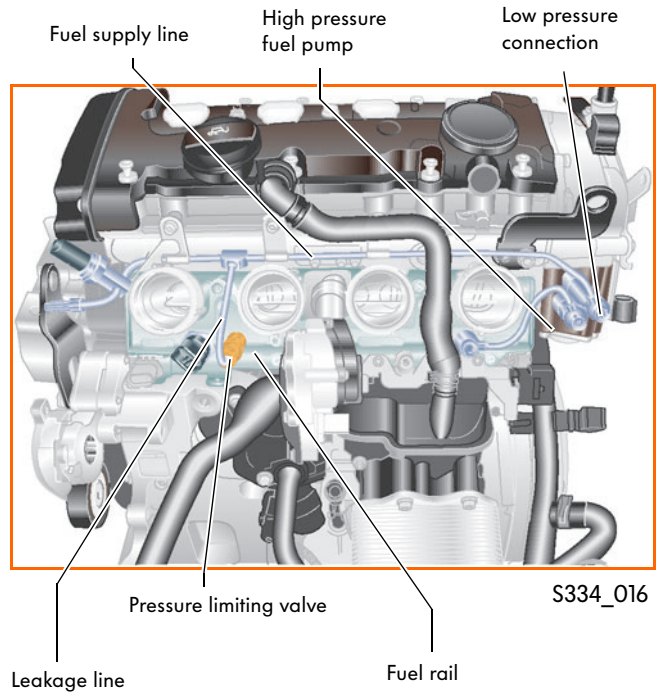

## Connecting piece with restrictor

The connecting piece between the fuel supply line and the leakage line contains a restrictor with a diameter of 1.5 mm.

It ensures that

- the high fuel pressure coming from the high pressure fuel pump is reduced during fuel return or
- the high fuel pressure coming from the fuel rail is reduced while the pressure limiting valve is open

This prevents pulses in the fuel line and stops any resulting noise transmitted by the fuel supply line fixing points to the body.

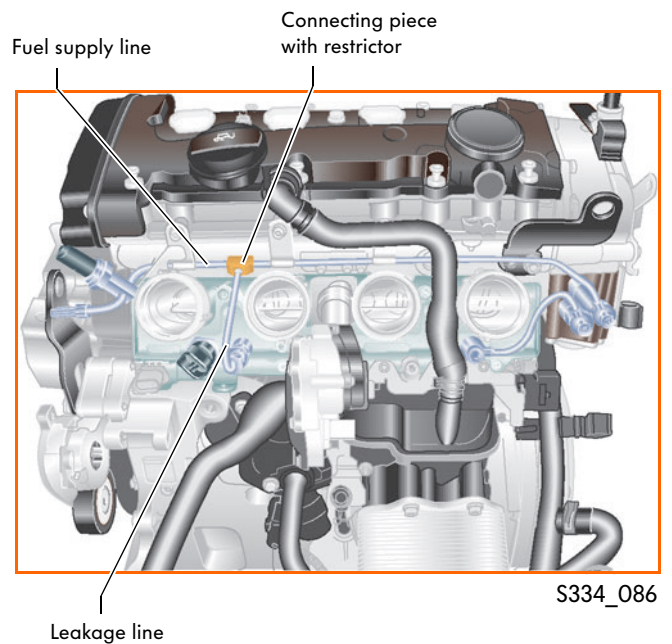

# Test your knowledge

**1. What purpose does the valve in the fuel filter serve?**

- a) The valve regulates fuel pressure in the low pressure fuel system to a constant 5 bar.
- b) The valve opens at a fuel pressure of approx. 6.8 bar to protect components.
- c) The valve closes at cold and hot starts, thus increasing fuel pressure to approx. 6.5 bar.

**2. At what frequency or frequencies do the engine control unit and the fuel pump control unit send the PWM signal (pulse-width modulated)?**

- a) Both control units send the signal at the same frequency of 20 kHz.
- b) The engine control unit sends at a frequency of 20 Hz and the fuel pump control unit sends at a frequency of 20 kHz.
- c) The engine control unit sends at a frequency of 20 kHz and the fuel pump control unit sends at a frequency of 20 Hz.

**3. After fuel system components have been renewed, is it necessary to carry out adaption using the guided fault finding routine?**

- a) No adaption is required.
- b) After renewing the engine control unit or the fuel pump control unit.
- c) After renewing every component.



1.) b; 2.) b; 3.) b

**Answers**

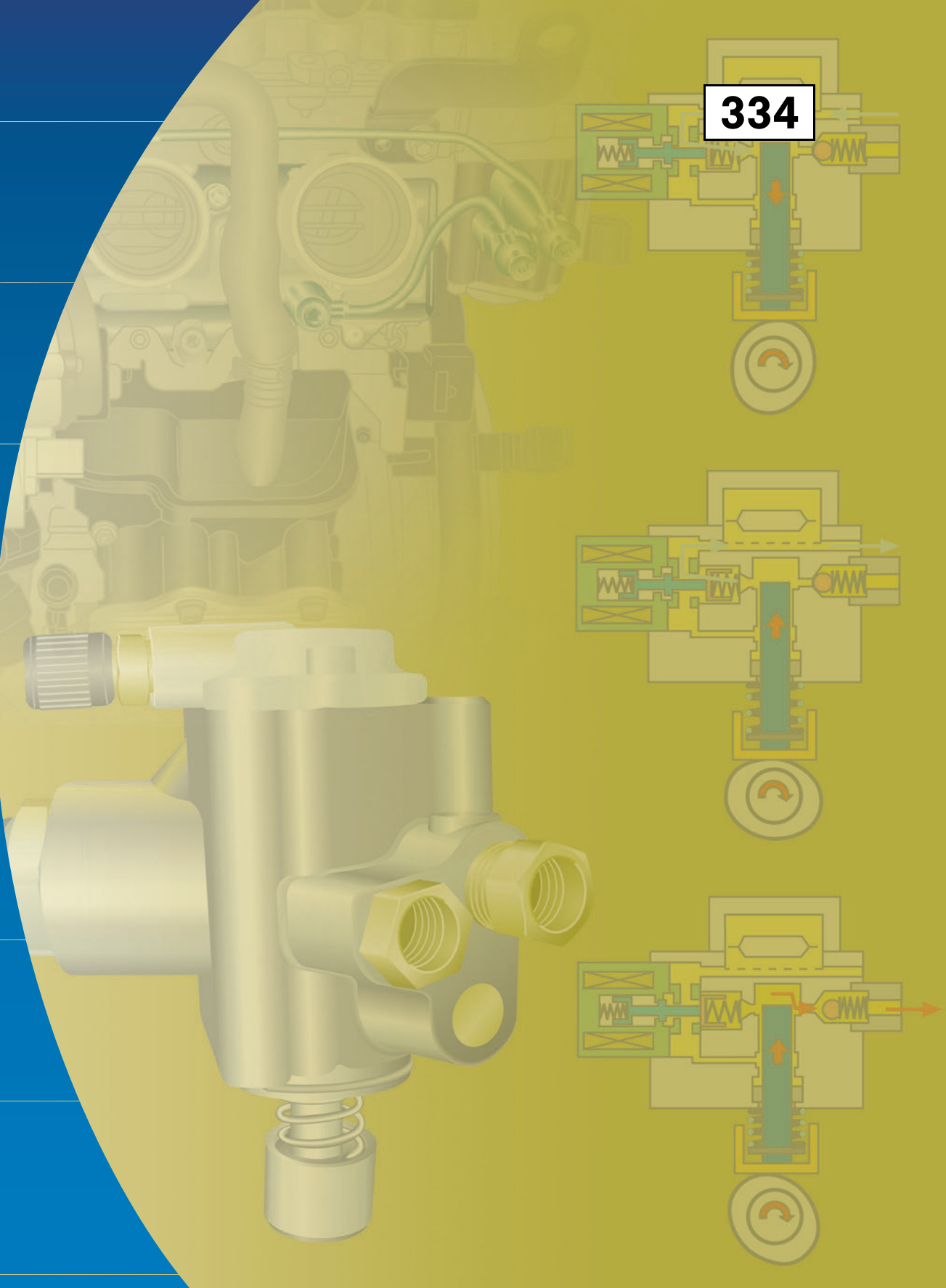

© VOLKSWAGEN AG, Wolfsburg, VK-21 Service Training

All rights reserved. Technical specifications subject to change without notice.

000.2811.49.20 Technical status: 09/04

 This paper was produced from pulp that was bleached without the use of chlorine.