

ENGINE CONTROLS

Engine Controls

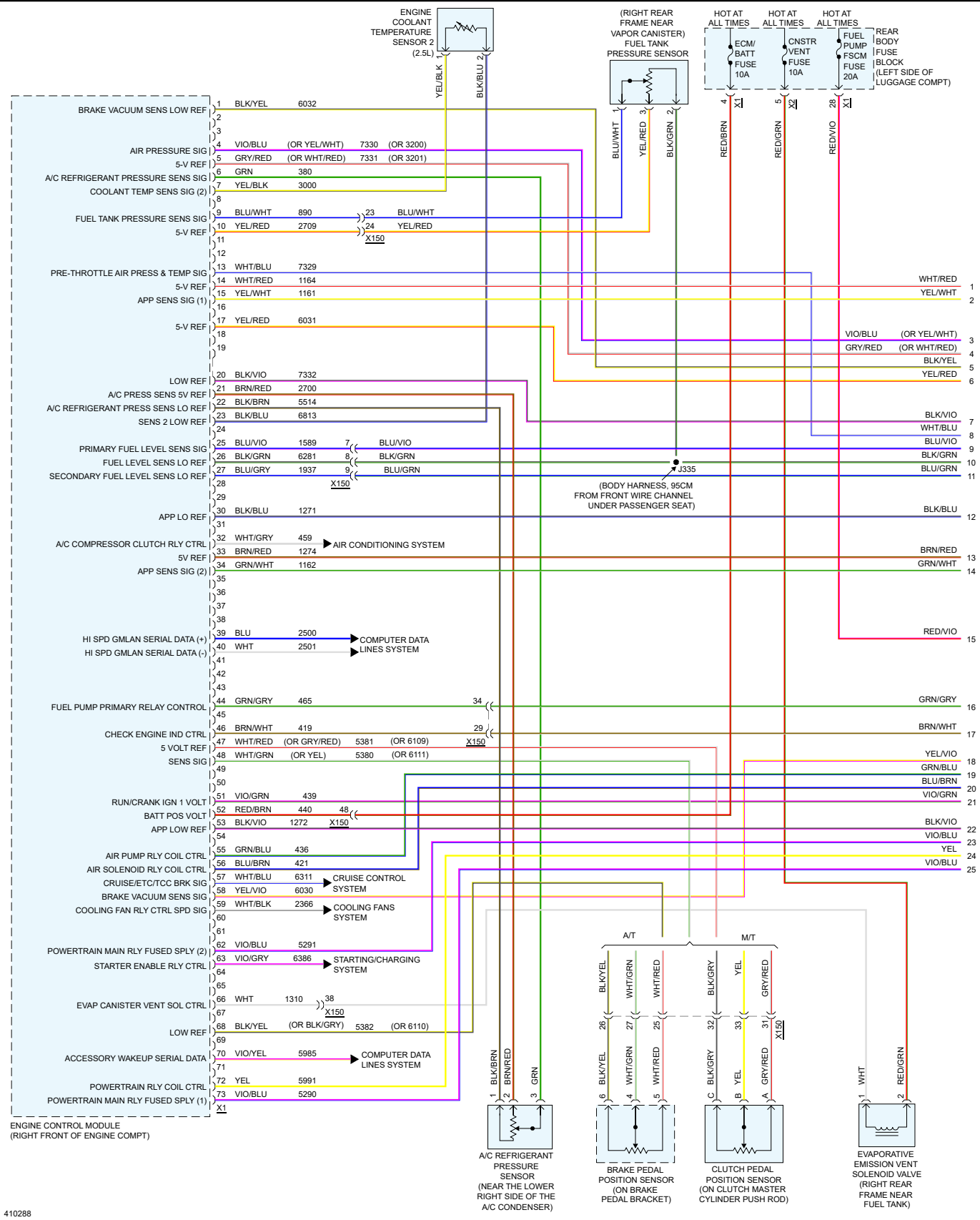

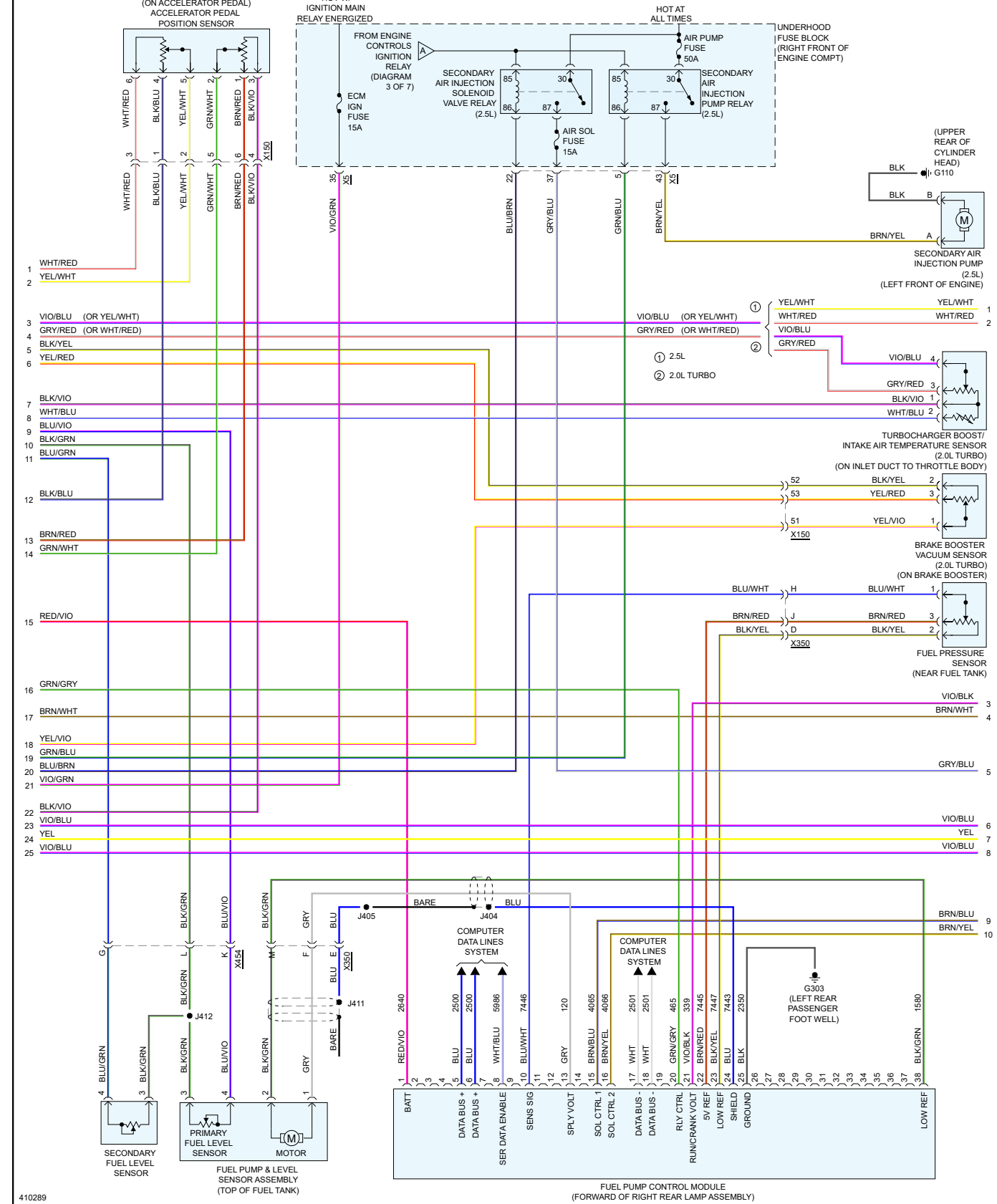

410289

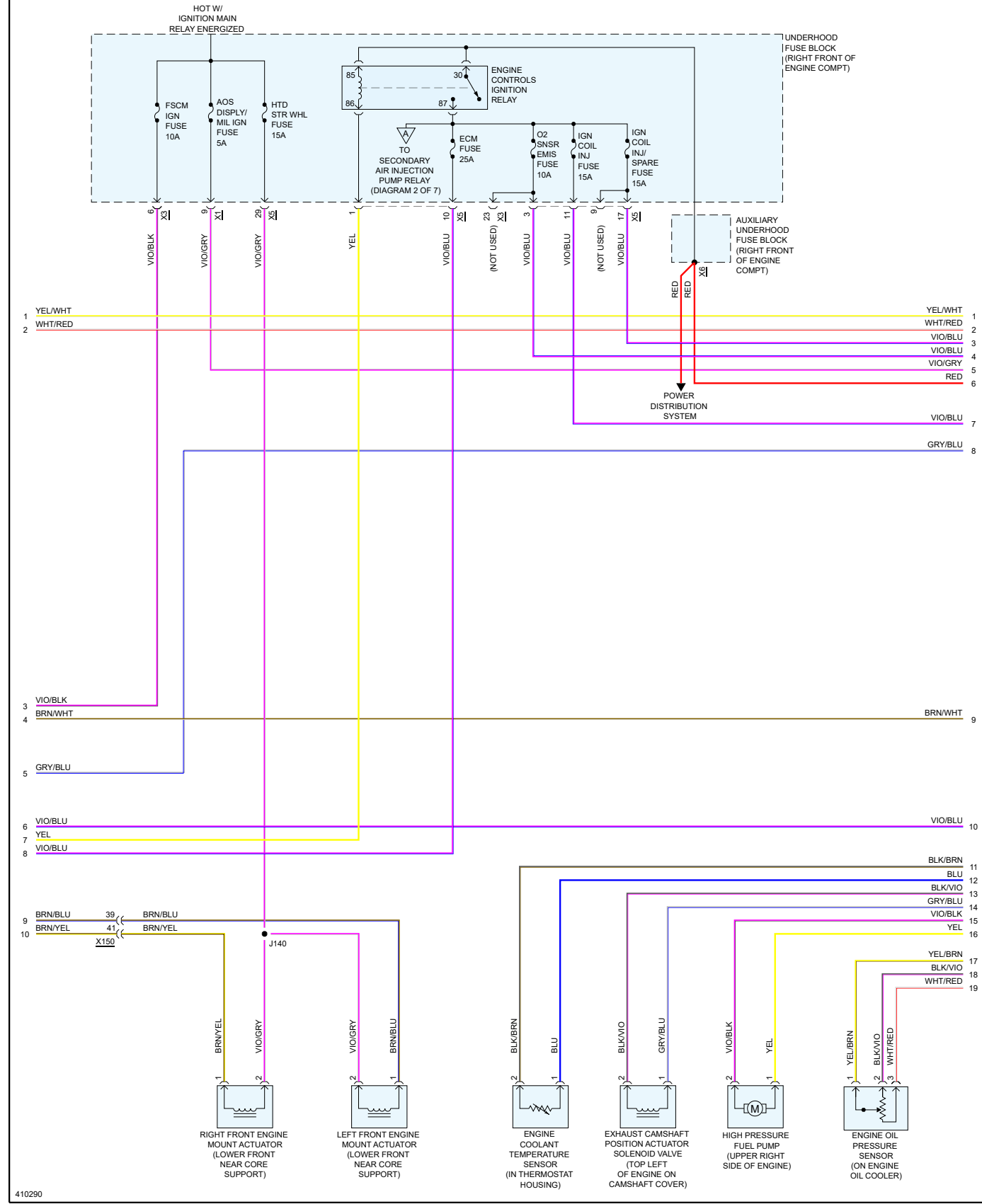

410290

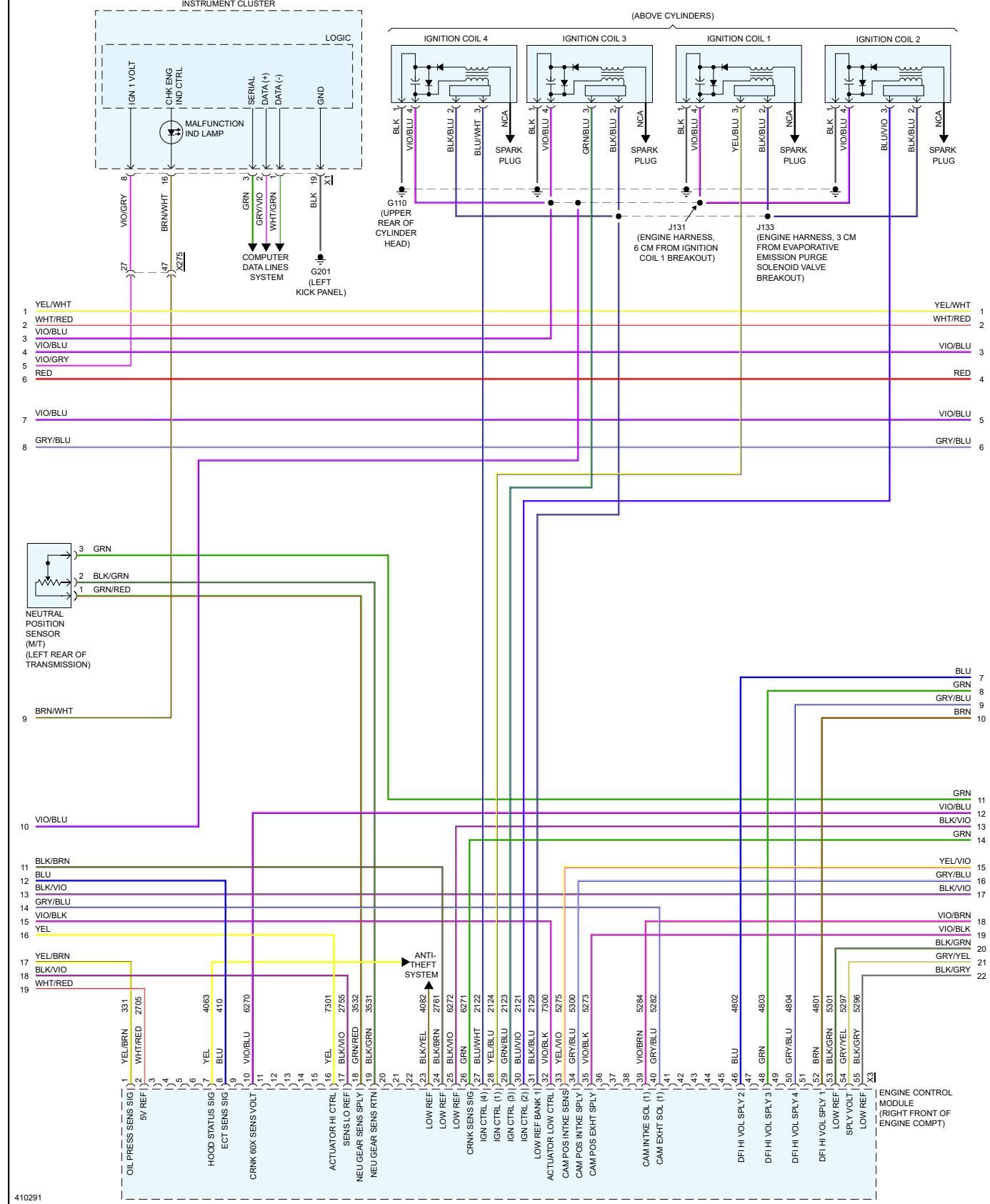

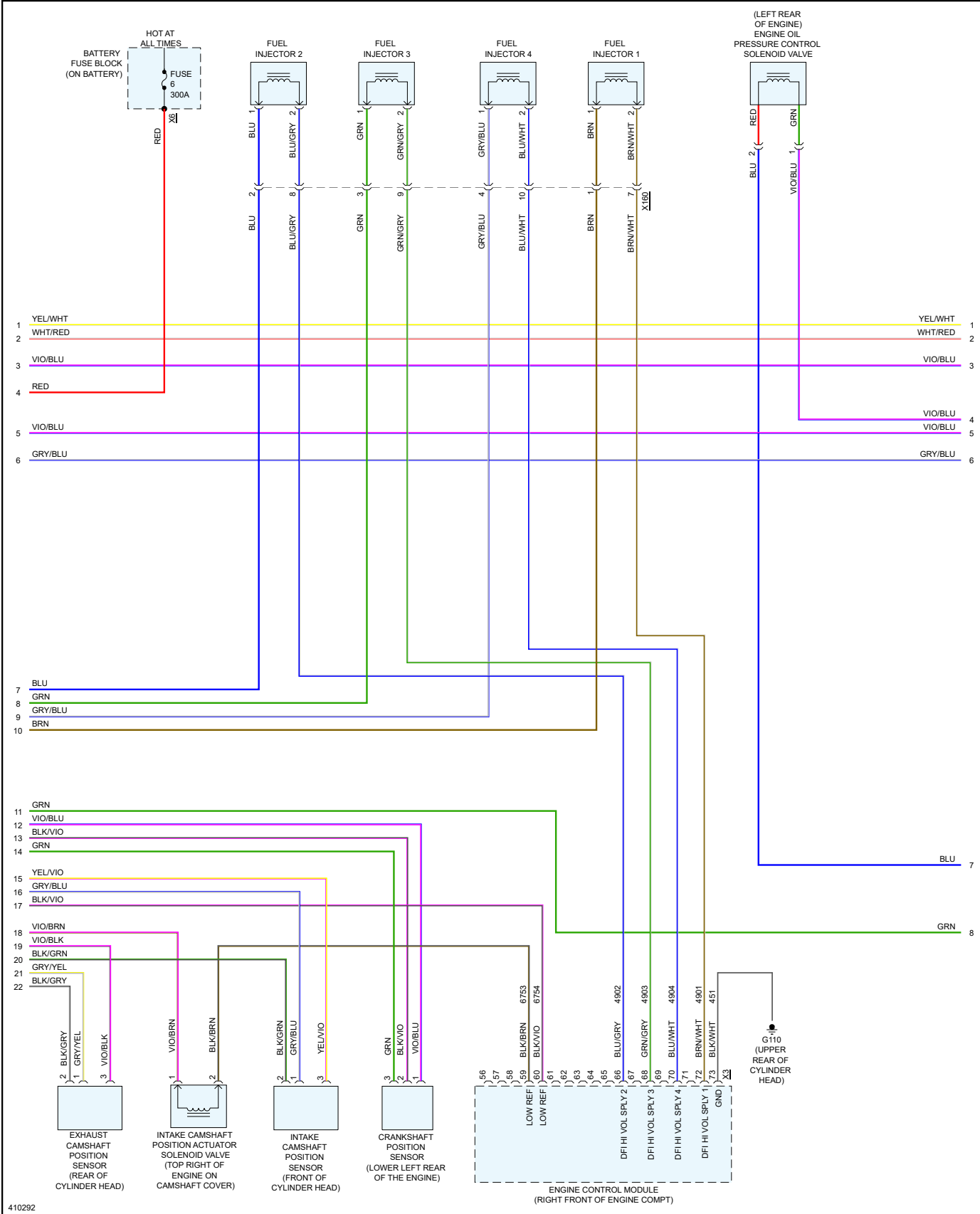

4110292

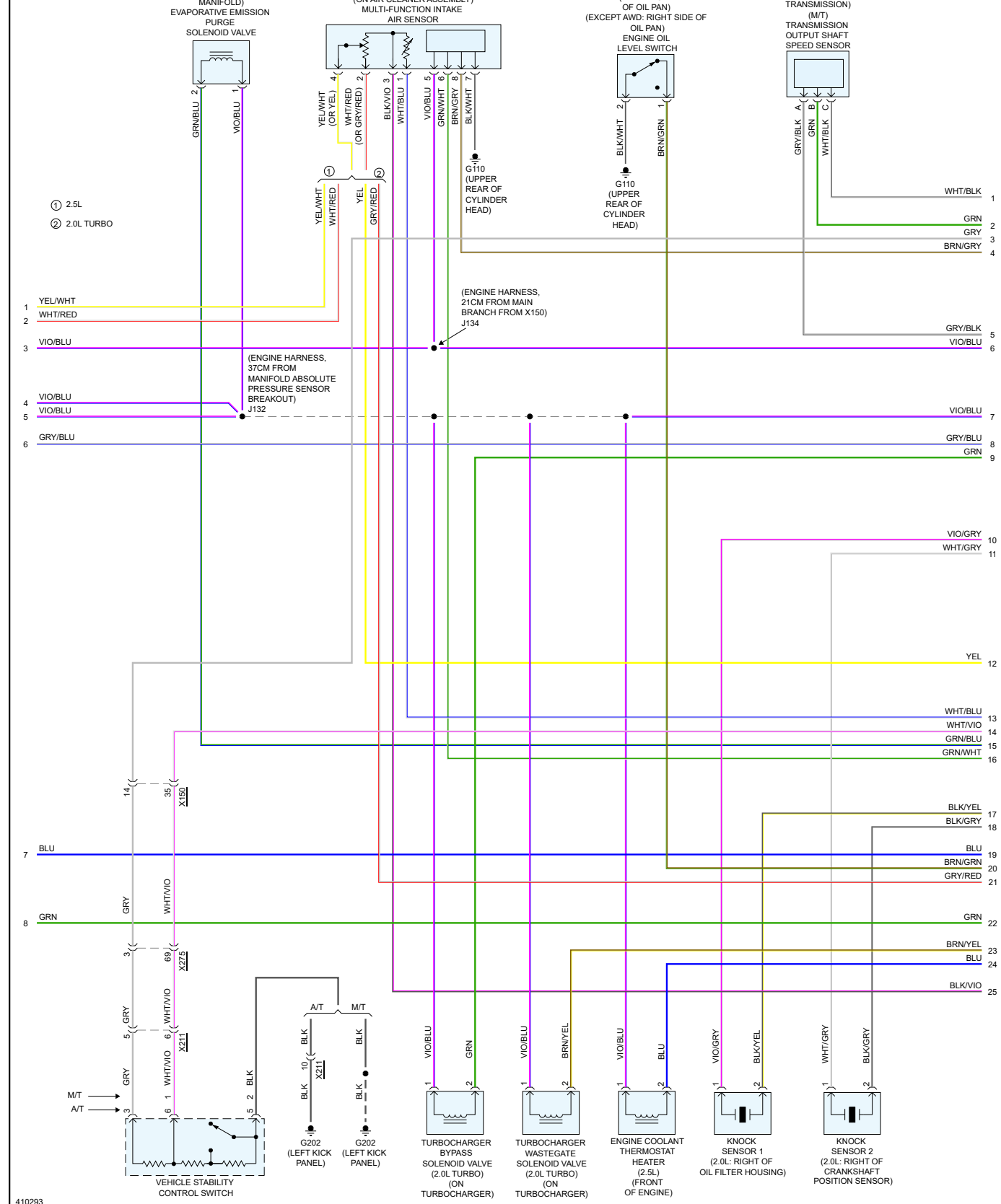

(AFTER CATALYTIC CONVERTER) HEATED OXYGEN SENSOR 2

(2.0L: IN EXHAUST MANIFOLD) HEATED OXYGEN SENSOR 1

SECONDARY AIR INJECTION SOLENOID VALVE (2.5L) (REAR OF EXHAUST MANIFOLD)

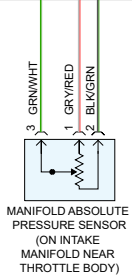
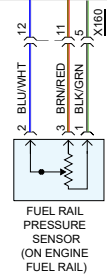
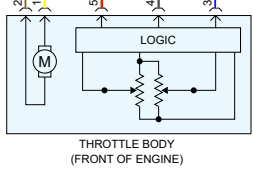
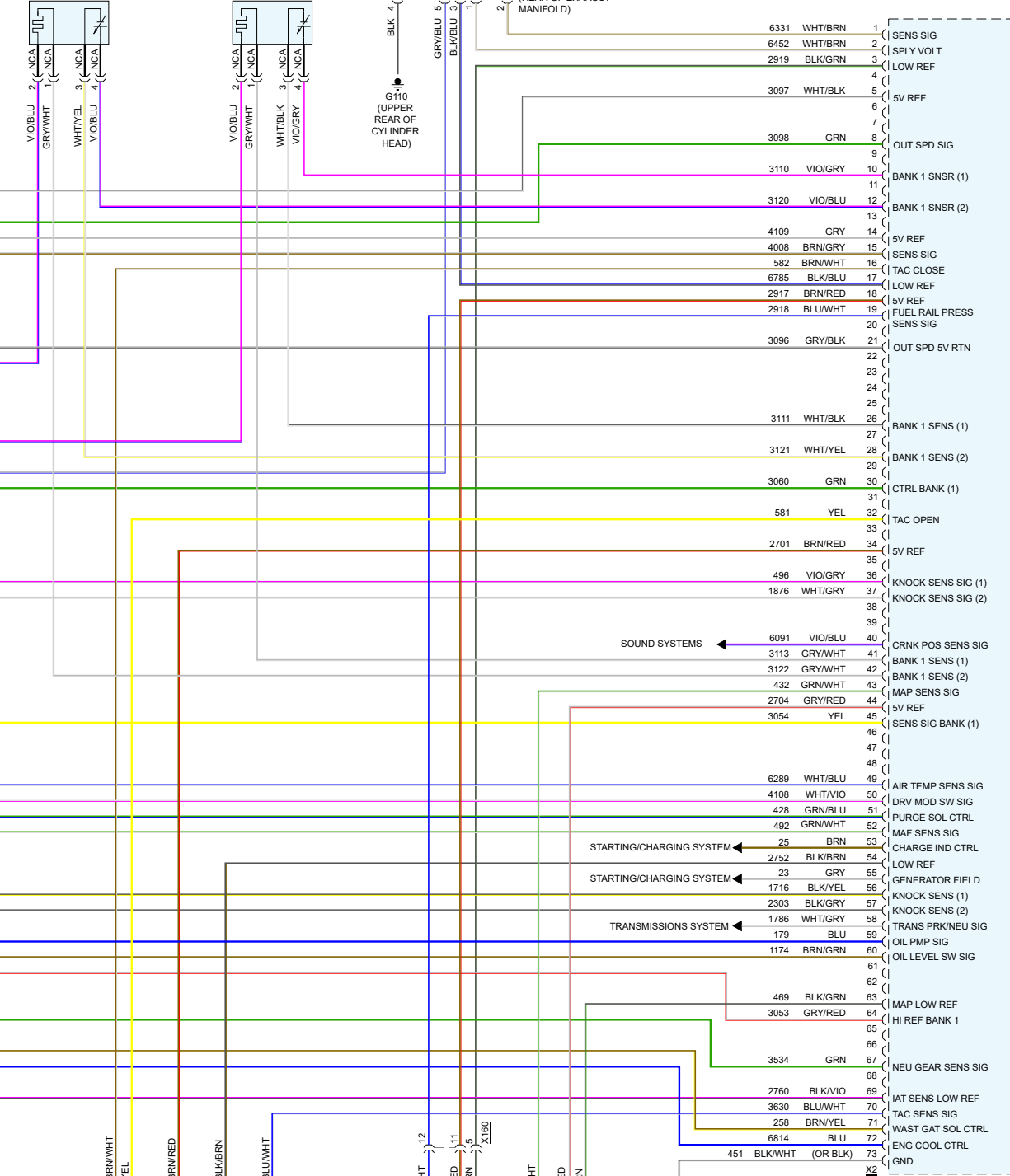

ENGINE CONTROL MODULE (RIGHT FRONT OF ENGINE COMPT)