

ENGINE CONTROLS

Engine Controls

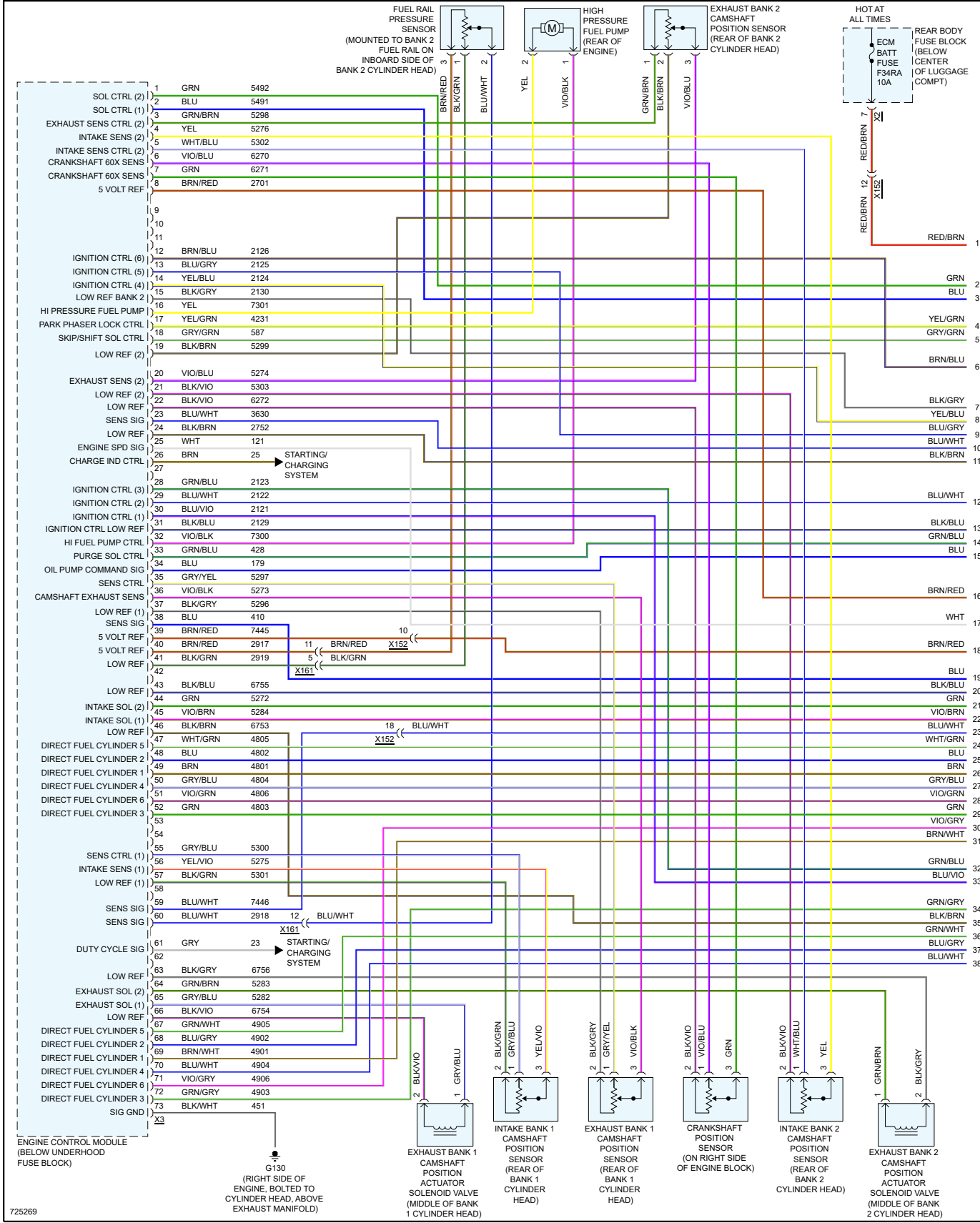

(INBOARD SIDE OF BANK 2 CYLINDER HEAD, ABOVE 2, 4 & 6 CYLINDERS)

(INBOARD SIDE OF BANK 1 CYLINDER HEAD, ABOVE 1, 3 & 5 CYLINDERS)

(REAR TOP OF ENGINE BLOCK) KNOCK SENSOR 2

(FRONT TOP OF ENGINE BLOCK) KNOCK SENSOR 1

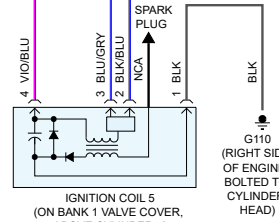
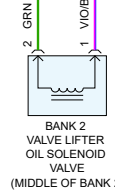
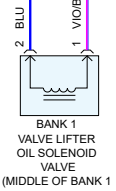
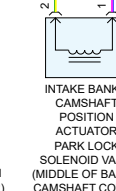
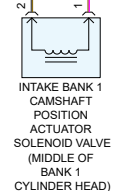
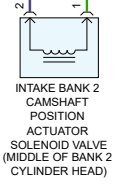
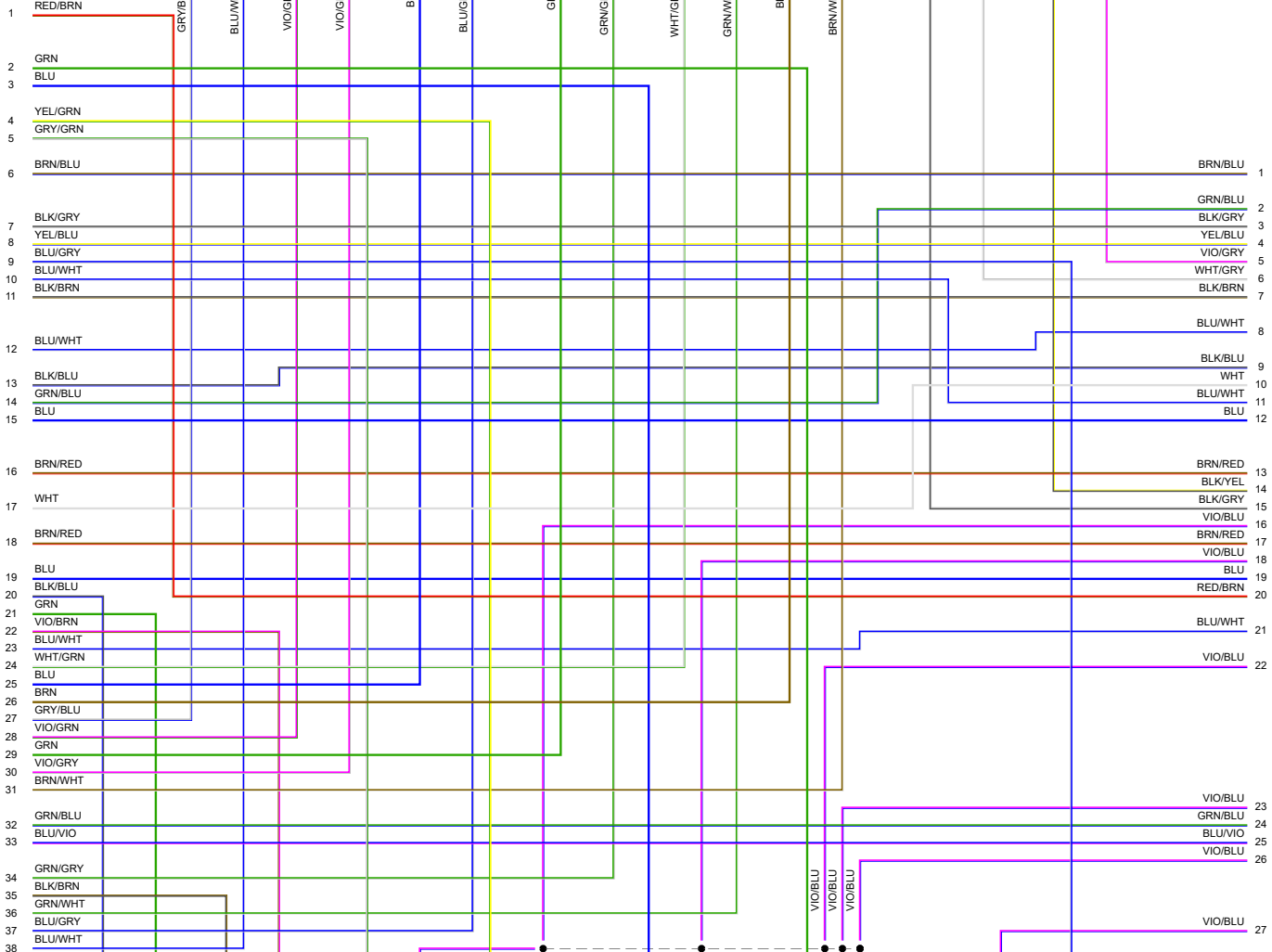
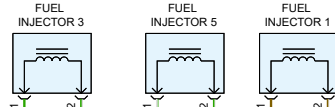
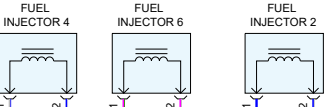

725270

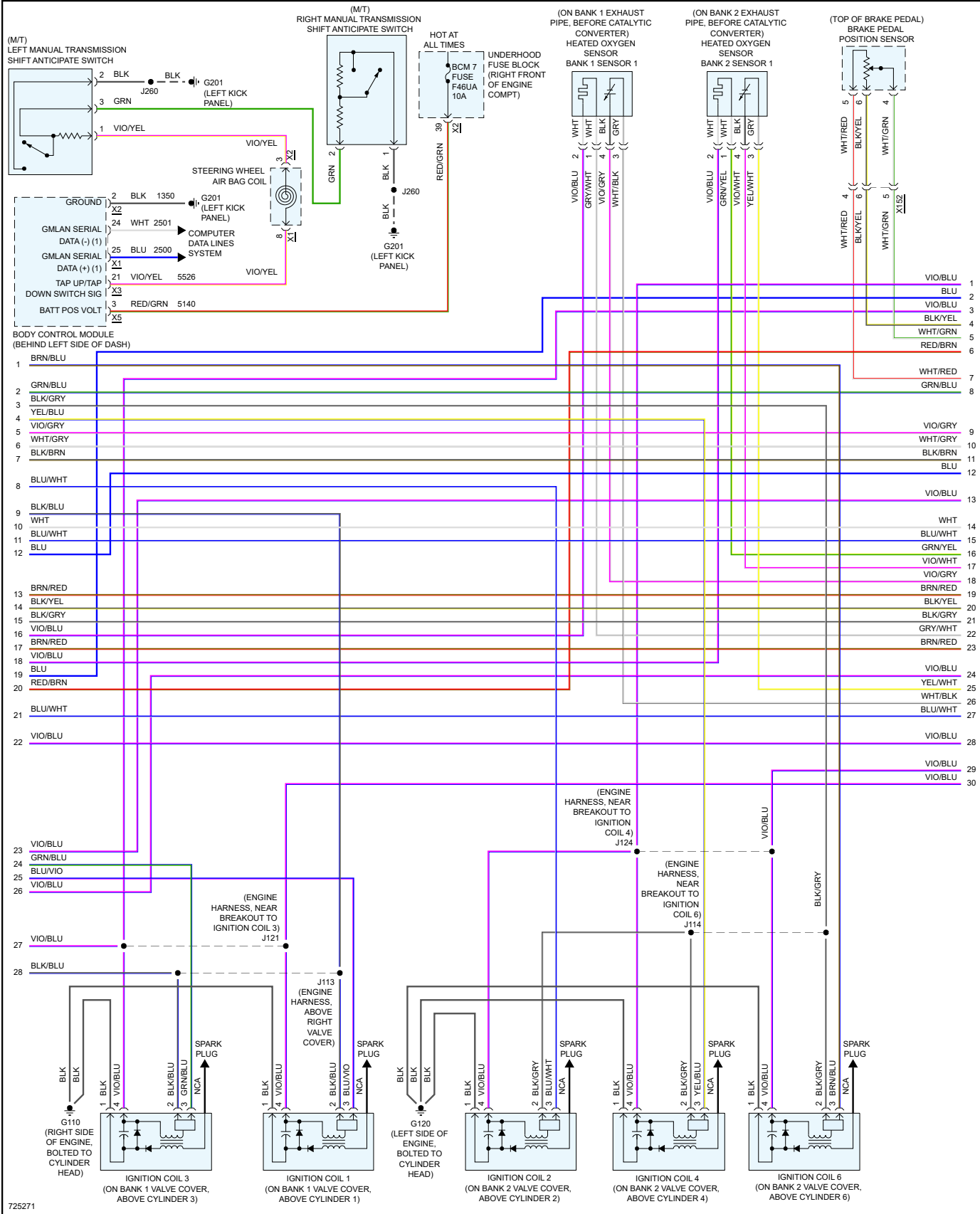

725271

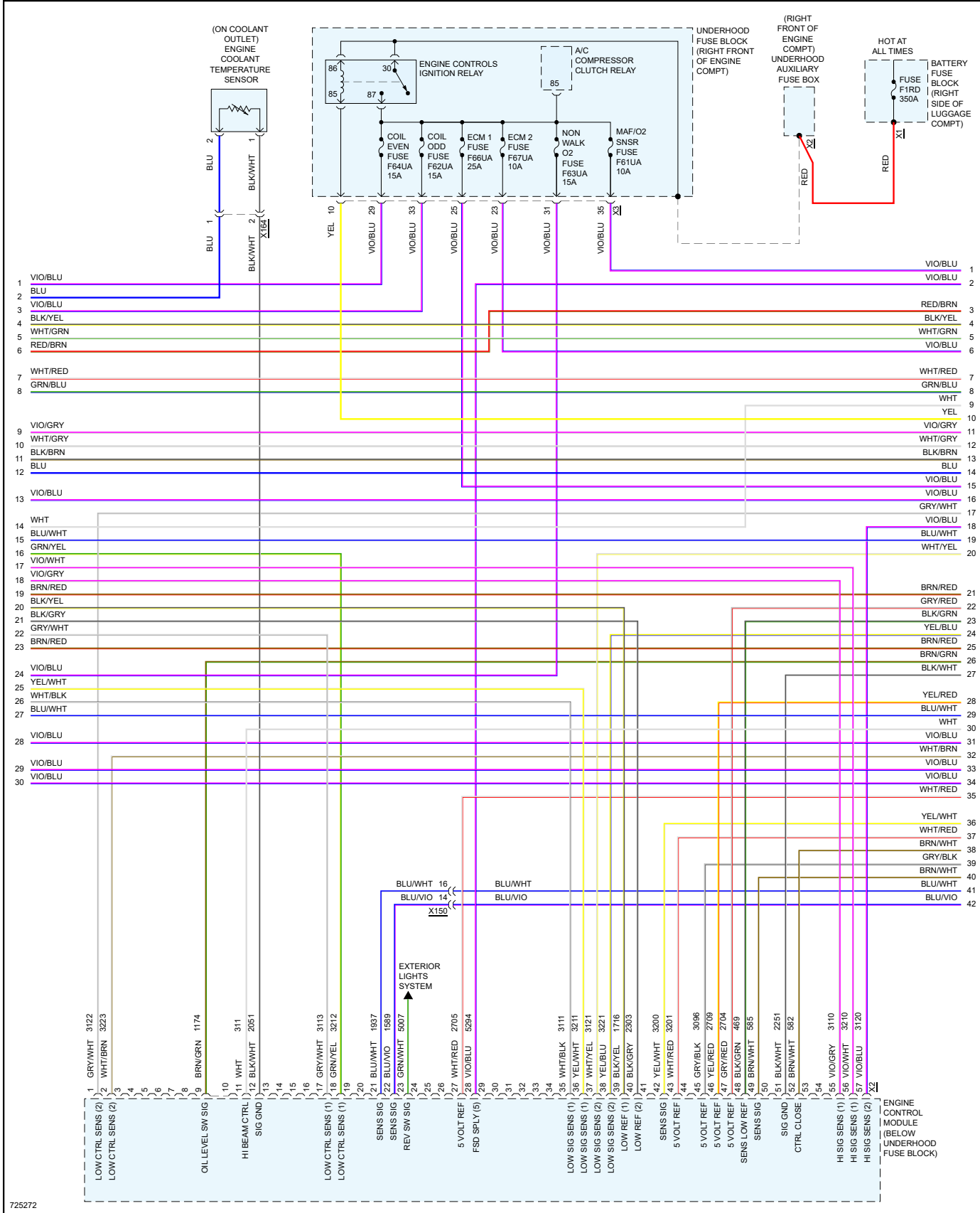

725272

(ON BANK 1 EXHAUST PIPE, AFTER CATALYTIC CONVERTER)

(ON BANK 2 EXHAUST PIPE, AFTER CATALYTIC CONVERTER)

(BELOW UNDERHOOD FUSE BLOCK)

(TOP OF INTAKE MANIFOLD)

HEATED OXYGEN SENSOR BANK 1 SENSOR 2

HEATED OXYGEN SENSOR BANK 2 SENSOR 2

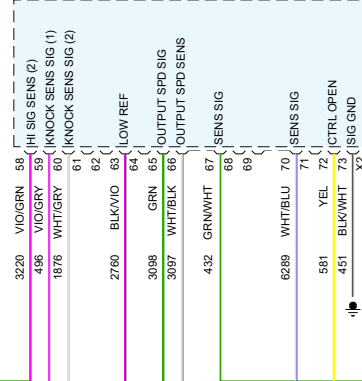

G130 (RIGHT SIDE OF ENGINE, BOLTED TO CYLINDER HEAD, ABOVE EXHAUST MANIFOLD)



(ENGINE HARNESS, NEAR BREAKOUT TO X175) J129

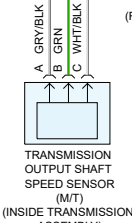
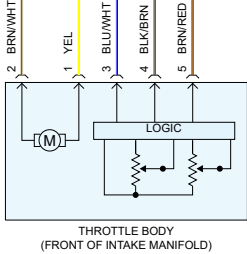
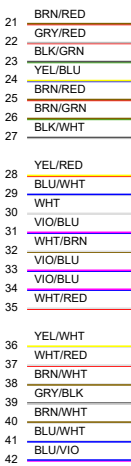
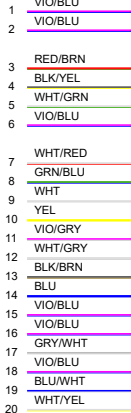

J326 (FUEL TANK HARNESS, ABOVE FUEL TANK)

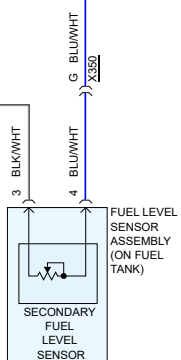
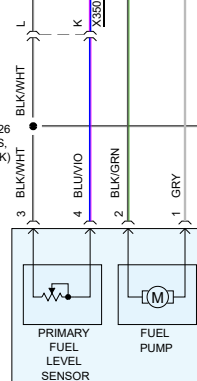

(BLUNT CUT SHIELD) NCA

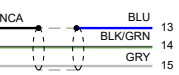

T25273

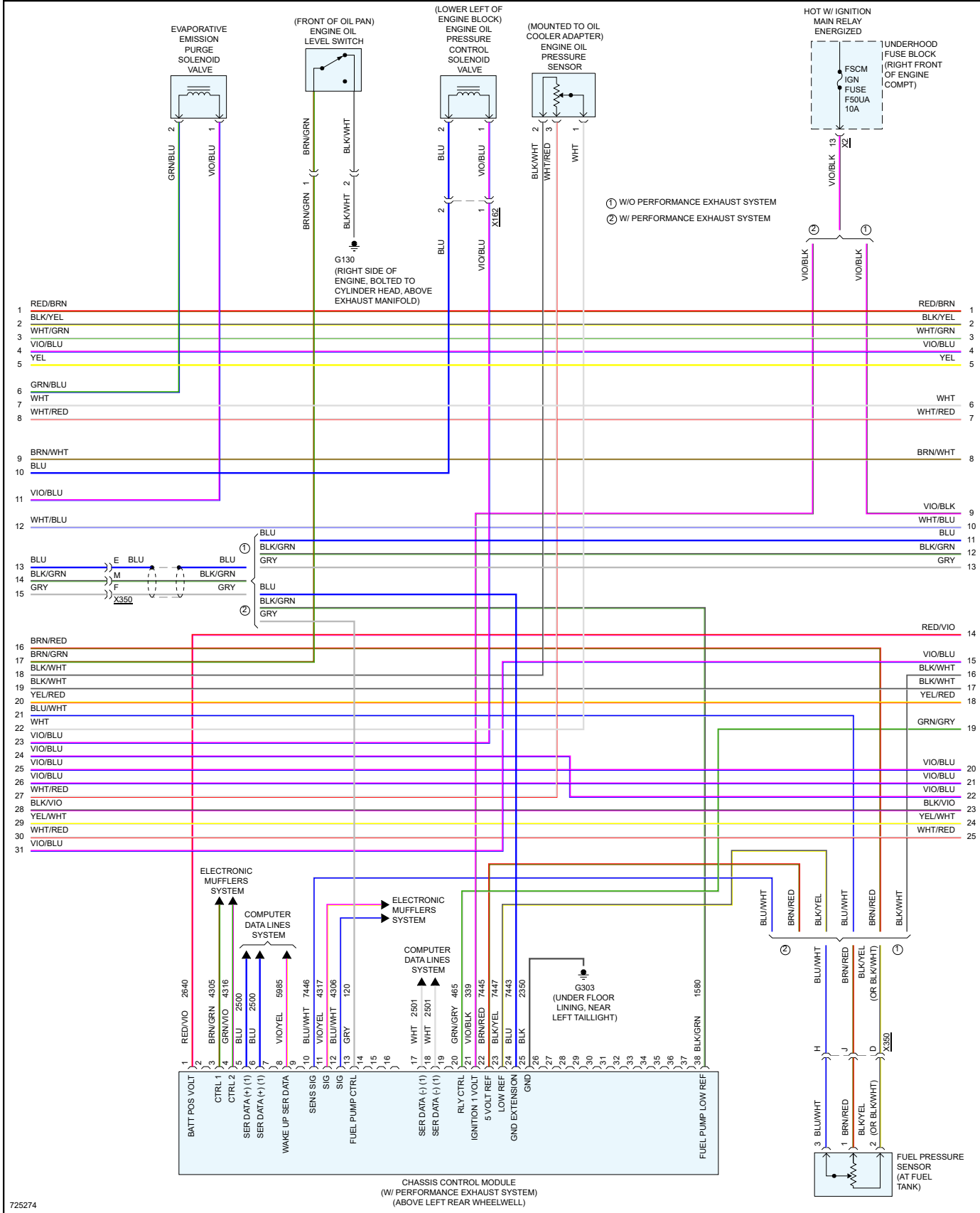

725274

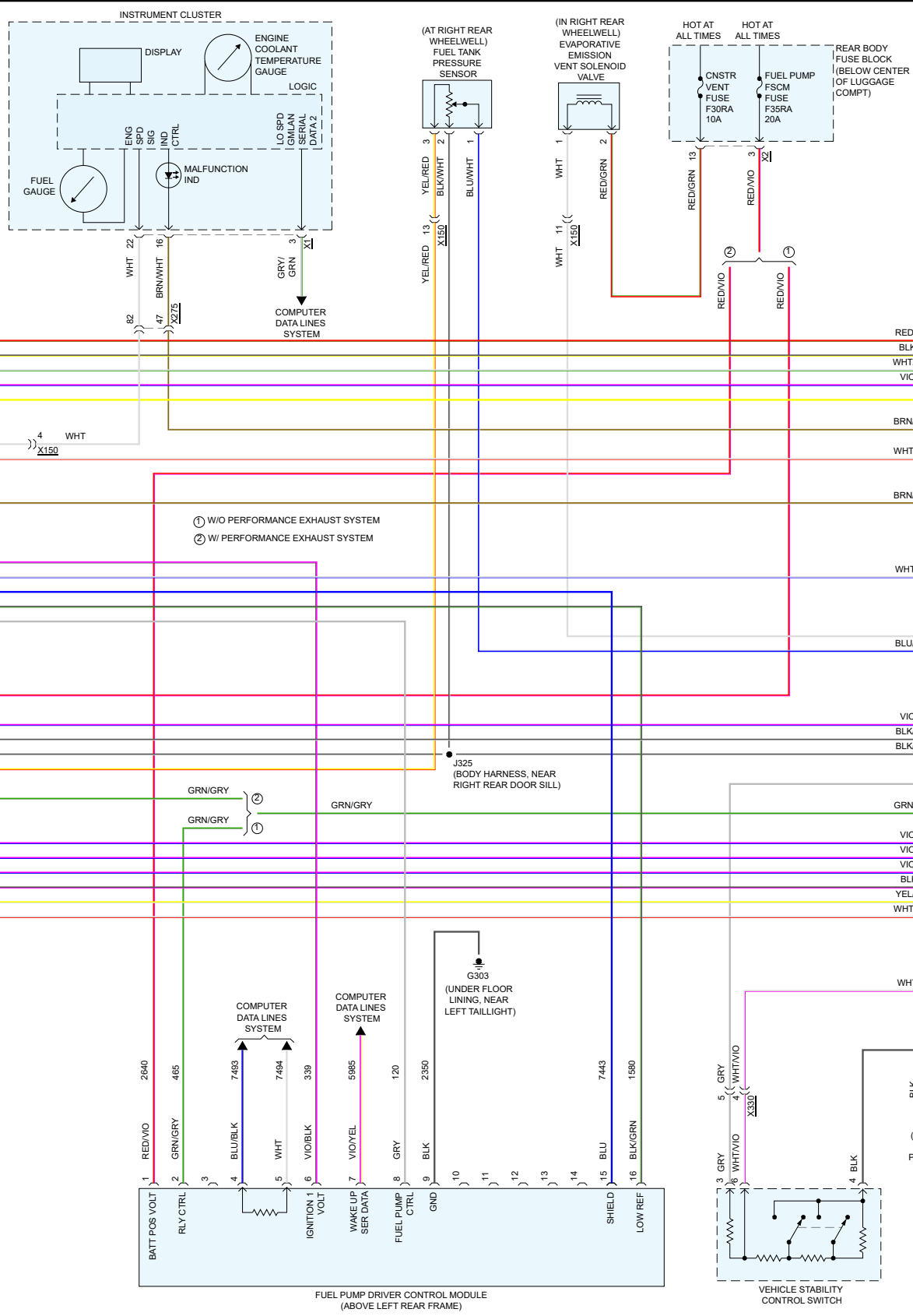

T25275

(MOUNTED TO TRANSMISSION ASSEMBLY)

(M/T) MANUAL TRANSMISSION FLUID TEMPERATURE SENSOR

(ON ARM OF CLUTCH PEDAL) (M/T) CLUTCH PEDAL POSITION SENSOR

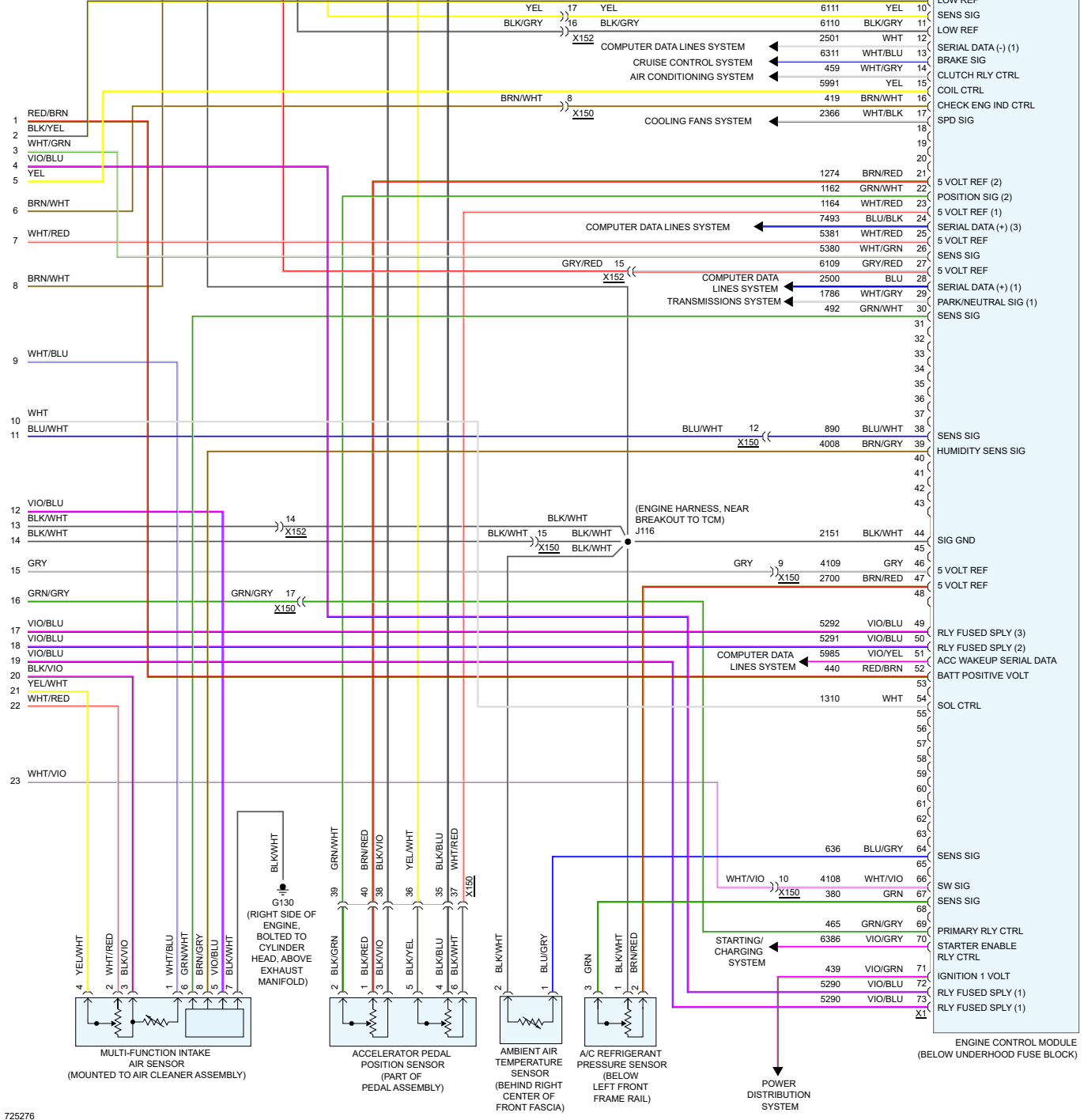
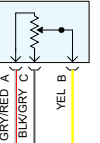
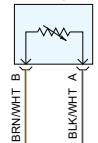

1	
2	
3	
4	
5	1272 BLK/VIO
6	1161 YEL/WHT
7	1271 BLK/BLU
8	7494 WHT
9	5382 BLK/YEL
10	6111 YEL
11	6110 BLK/GRY
12	2501 WHT
13	6311 WHT/BLU
14	459 WHT/GRY
15	5991 YEL
16	419 BRN/WHT
17	2366 WHT/BLK
18	
19	
20	
21	1274 BRN/RED
22	1162 GRN/WHT
23	1164 WHT/RED
24	7493 BLU/BLK
25	5381 WHT/RED
26	5380 WHT/GRN
27	6109 GRY/RED
28	2500 BLU
29	1786 WHT/GRY
30	492 GRN/WHT
31	
32	
33	
34	
35	
36	
37	
38	
39	890 BLU/WHT
40	4008 BRN/GRY
41	
42	
43	
44	2151 BLK/WHT
45	
46	4109 GRY
47	2700 BRN/RED
48	
49	5292 VIO/BLU
50	5291 VIO/BLU
51	5985 VIO/YEL
52	440 RED/BRN
53	
54	1310 WHT
55	
56	
57	
58	
59	
60	
61	
62	
63	
64	636 BLU/GRY
65	
66	4108 WHT/VIO
67	380 GRN
68	
69	465 GRN/GRY
70	6386 VIO/GRY
71	439 VIO/GRN
72	5290 VIO/BLU
73	5290 VIO/BLU
X1	