

EML IIIs Electronic Throttle Control (Siemens)

Training
Reference
Manual

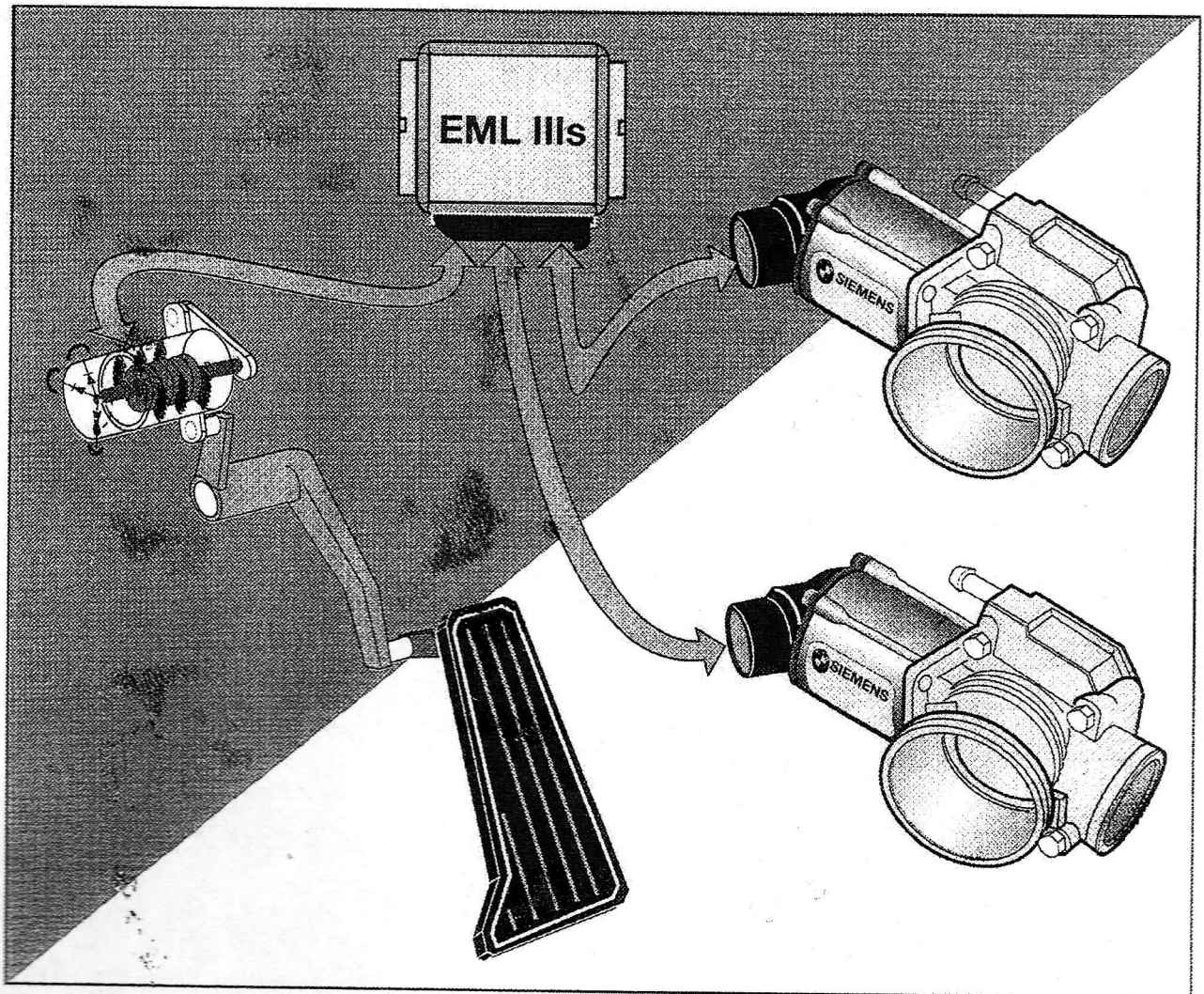
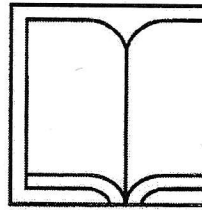

TABLE OF CONTENTS

Subject	Page
Introduction	2
Components	4
• Throttle Valve (DK) Motors	6
• Throttle Position Sensor	9
• External Safety Path	11
• Basic Adaption of the PWG	12
• EML IIIS Control Module	13
Cruise Control Operation	15
Cylinder Bank Synchronization	16
Fault Recognition/Diagnosis	17

INTRODUCTION

The EML III is a newly developed electronic throttle control system for the M73 V-12 engine. The EML III was designed and developed by Siemens to BMW specifications.

The concept of the EML III system remains the same as the current EML system used on the M70 engine. The new EML III system continues to use two throttle valves and one pedal position sensor (PWG). The EML III control module regulates the position of the throttle valves based on the input from the pedal position sensor. These main components provide the same function as the M70 Bosch EML components do.

In addition to throttle control, the main functions of the EML III include:

- Idle stabilization by regulating the throttle openings at idle.
- Throttle valve positioning for optimum starting.
- Synchronization of the cylinder banks.
- Air volume control for ASC/DSC operation.
- Cruise control regulation (the EML III control module contains the new GR II logic introduced on the E38 740).
- Maximum road speed limiting

The operation of the EML III has been enhanced with additional backup (redundancy) features. This helps ensure reliable operation while maintaining a high level of operational safety.

The fault memory of the EML III control module is now stored in an EEPROM so that disconnection of the battery will not erase any stored faults.

The EML III system is incorporated into the driving management system and is connected to the CAN line for signal interfacing with the DME, ASC+T and AGS control modules.

Highlights of the new EML III system include:

- The EML III control module contains two separate processors for redundant checking of inputs and output controls.
- Each throttle valve is now controlled by two separate stepper motors driving one rotor and shaft (redundancy operation).

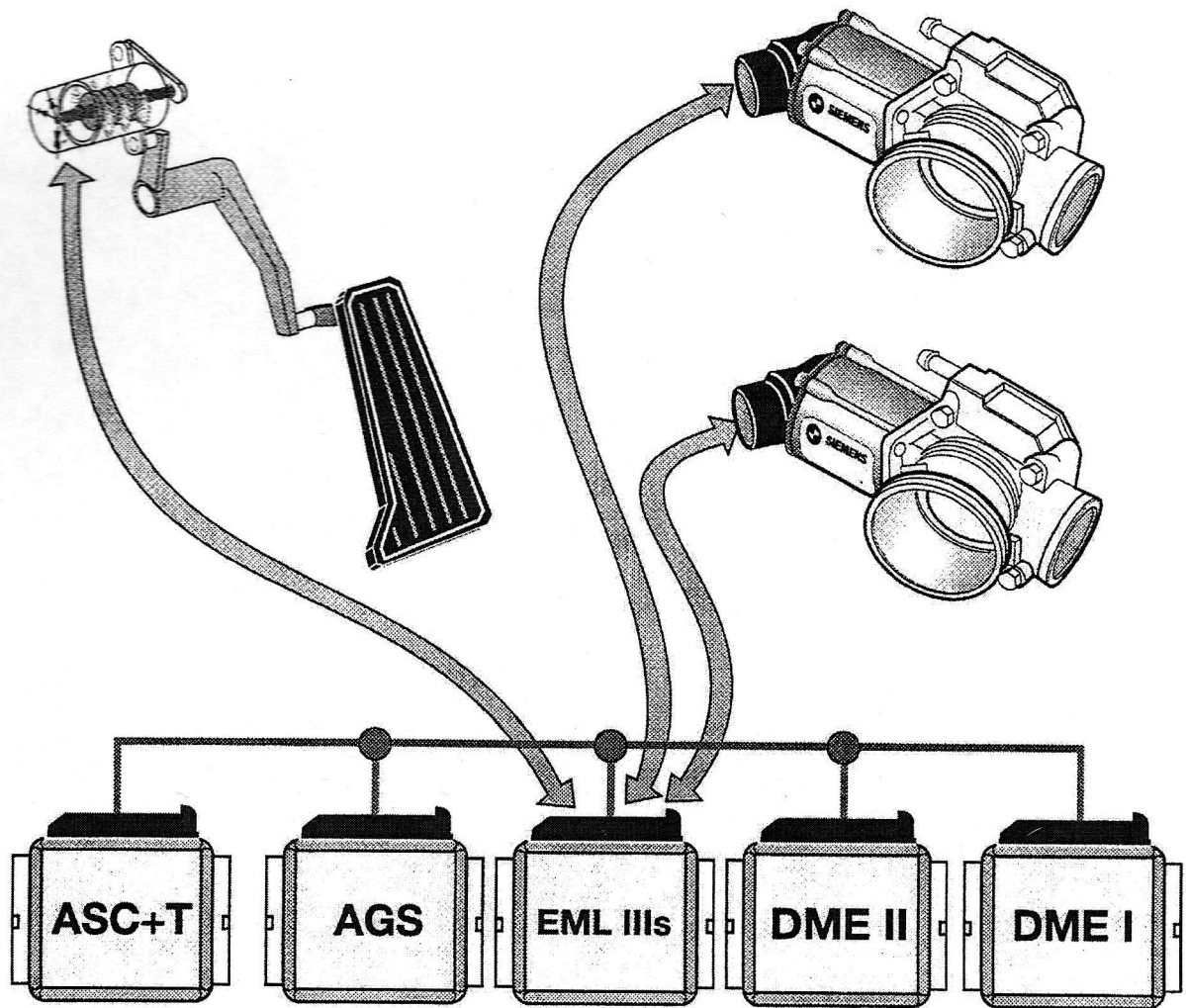

- Each DK assembly contains two feedback potentiometers for throttle position recognition.
- The pedal position sensor (PWG) now contains three inductive coils for the pedal position input (redundancy operation).
- The hall sensor brake pedal switch is used for the brake pedal input.
- Logic monitoring of pedal/throttle valve operation no longer includes the use of the 9° and 17° switches.
- The external safety path circuit is a new design.
- E38 EML fault indication is now handled by the Check control module, through the instrument cluster matrix display.

COMPONENTS

The main components of the EML III system include:

- The EML III control module - located in the E-box.

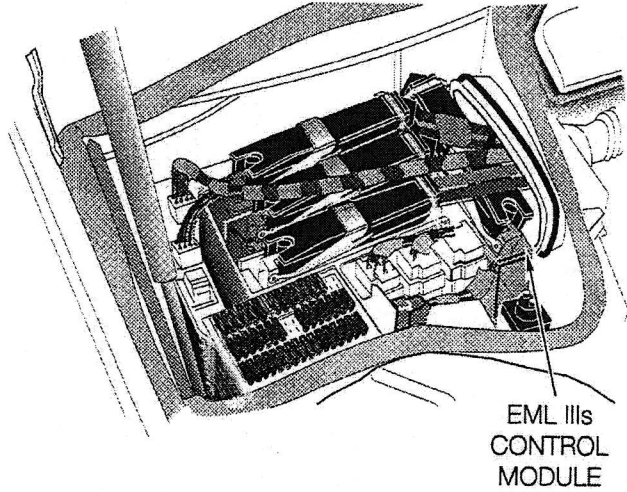

- Two throttle (DK) assemblies - mounted on each intake manifold.

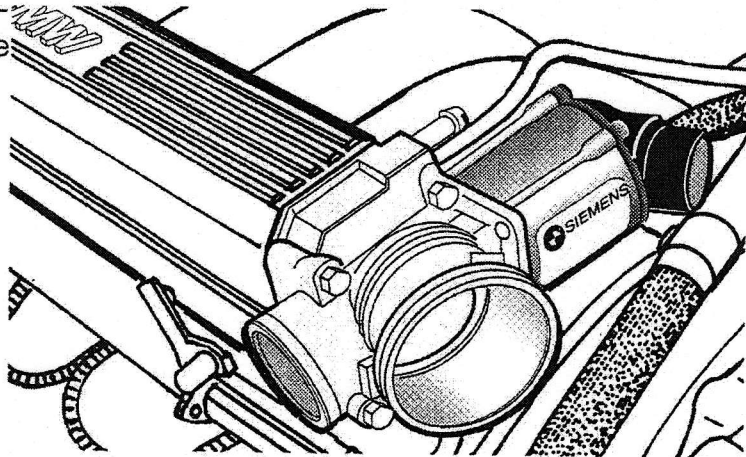

- One pedal position sensor (PWG) - connected to the accelerator pedal (with a separate kick-down switch).

- Electronic brake light switch.

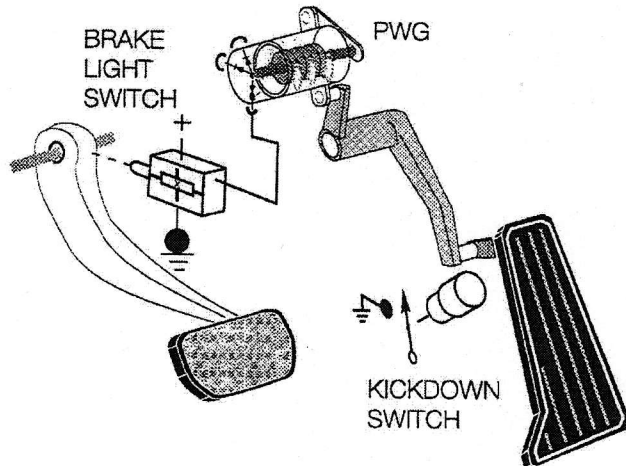

- Cruise control main switch - mounted on the instrument panel. Provides a switched ground input to the EML control module. (E38 only)

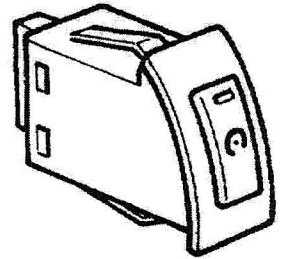

- Multi-Function Steering Wheel - cruise control switch pad and the MFL control module. (E38 only)

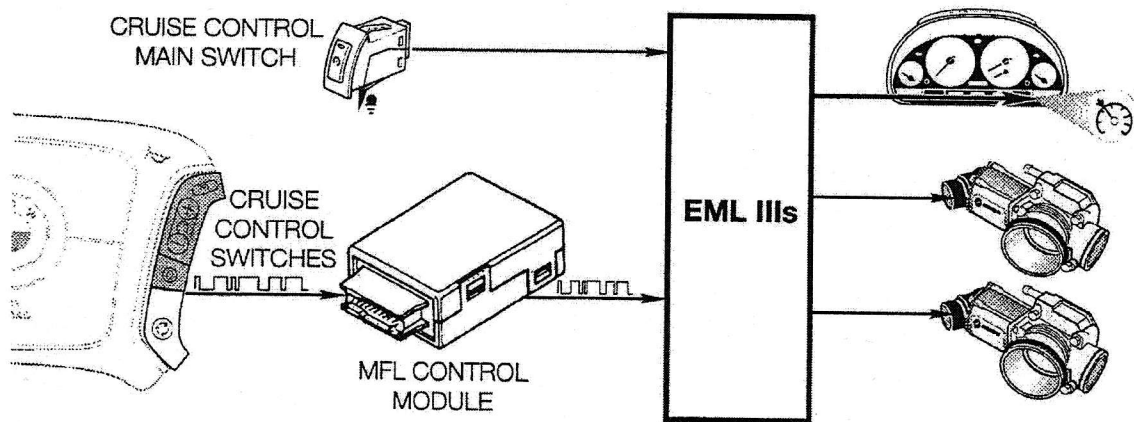

- Check control module - for activation of the fault warning display.

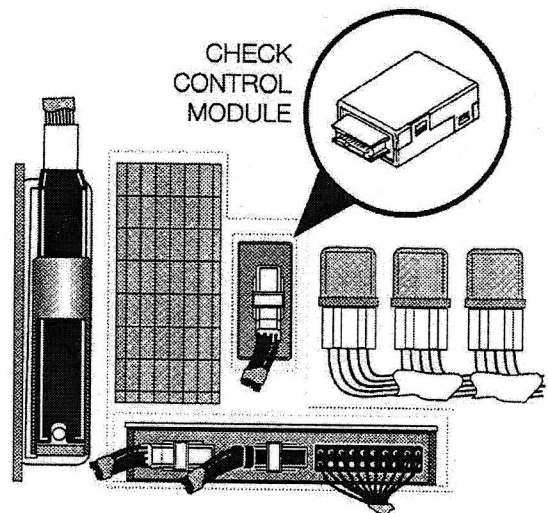

THROTTLE VALVE (DK) MOTORS

The throttle valve assembly consists of the DK housing with the throttle valve plate, return spring, drive motor and feedback potentiometers. In contrast to the M70 - EML system, the EML III's throttle valve plate is driven directly by the motor shaft. The gear drive is eliminated which allows for a more precise control of the throttle plate positioning.

A dual stepper motor configuration is used to drive the throttle plate. Both stepper motors are controlled through separate final stages in the EML control module and operate on the one armature. The final stages for one stepper motor windings are controlled by one micro processor while the second motor windings are controlled by the second processor. The control of the stepper motors takes place simultaneously by each processor.

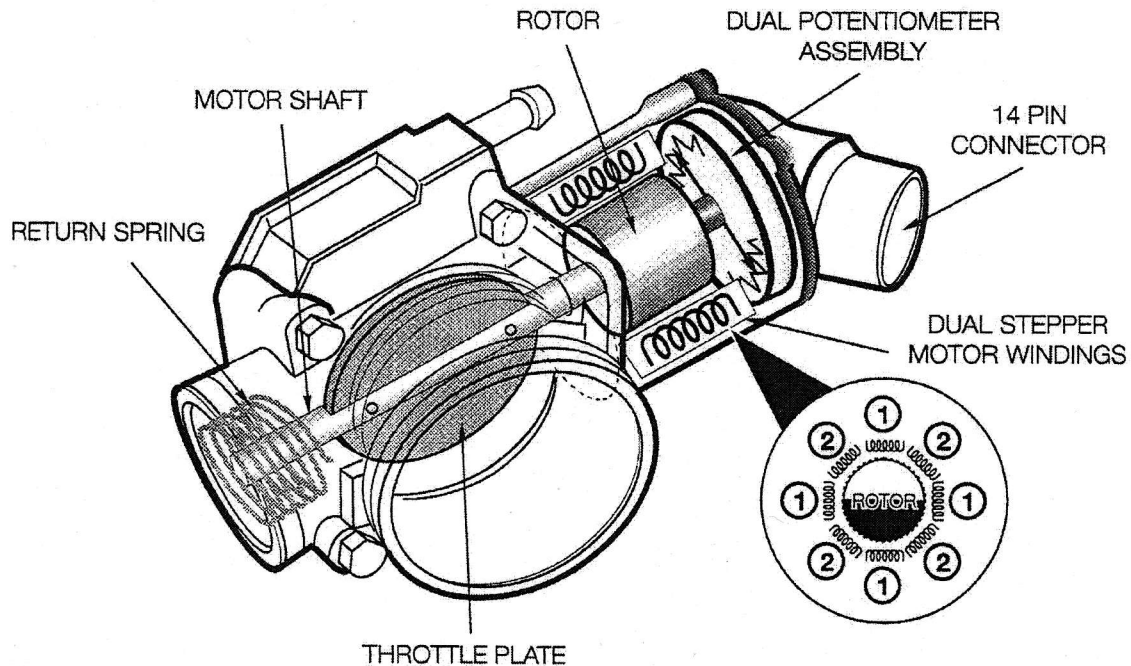

The dual feedback potentiometers signal the movement and position of the throttle plate to each processor. The two potentiometers have separate power and ground circuits to ensure the reliability of their operation.

This dual redundancy system allows the EML III's to continue operation, without driver inconvenience, if one stepper motor or control circuit malfunctions. If the self diagnosis of the EML III's detects a fault with one of the stepper motor controls, it will switch off the affected circuit and continue operation from one motor control circuit. The fault will be logged and the EML fault warning will be displayed in the cluster matrix.

If a fault occurs that cannot allow continued operation of the throttle valve, the control for that bank of cylinders will be switched off as with the previous EML system.

Stepper Motor Control

A digital square wave signal is used to drive the stepper motor of the DK assembly. The duty cycle of the frequency and trigger of the signal are changed to produce the magnetic field required to move the stepper motor rotor.

Each set of stepper motor windings are controlled by four final stages. Each final stage has the ability to switch between power and ground to reverse the direction of current flow through the windings (trigger). This switching allows the magnetic field of the coils to be reversed allowing the rotor to be driven in either direction to position the throttle plate at the precise setting called for by the PWG input request.

The final stage control varies the duty cycle to control the speed of movement and position of the throttle plate.

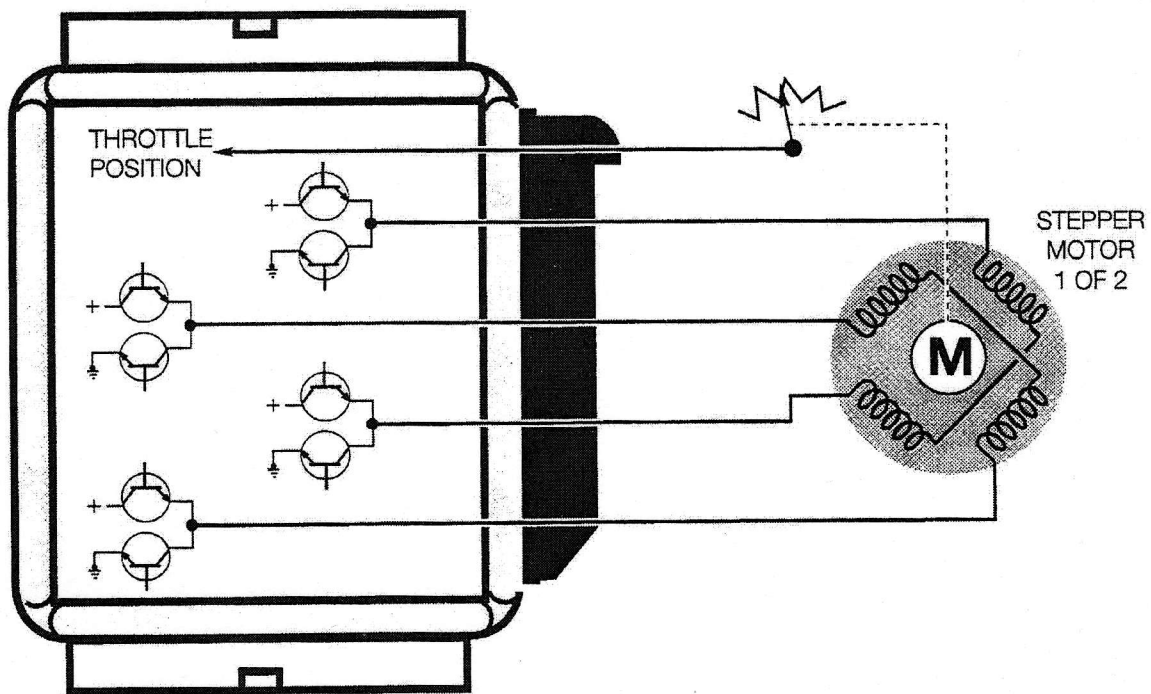

Self Diagnosis: The scope of EML 's self diagnosis for stepper motor operation includes:

- Checking
 - Both throttle valves are checked dynamically prior to engine starting (part of pre-start check with KL 15 on).
 - All eight final stage controls per stepper motor when KL 15 is switched on.
- Monitoring
 - The supply voltages for all potentiometers.
 - Throttle valve set position with the feedback potentiometers position.
 - Comparing the two potentiometer signals.
 - Comparing the set points calculated by each individual processor.
 - The throttle valve operation for OBD II checking requirements.

CONDITIONS OF STEPPER MOTOR CONTROL

Starting: The EML IIIs control module will position the throttle valves to the optimum opening for engine start when it receives the KL 50 input over the CAN line.

Idle: The EML IIIs programming will maintain a stable idle by adjusting the opening of the throttle valves when the vehicle is at a standstill. The EML receives the engine RPM signal from the DME control module over the CAN line.

The idle will be stabilized for A/C compressor activation to compensate for the load of the compressor.

The EML receives TD and AC on signals over the can line.

Decel Fuel Cutoff: Decel fuel cutoff is activated based on the input from the pedal position sensor and the engine RPM signals. A high signal is supplied from the EML control module to the DME control modules for the purpose of activating decel fuel cut off.

These input signals to the DME control modules are separate hard wire lines that are also used for the "safety fuel cut off" feature of the EML control.

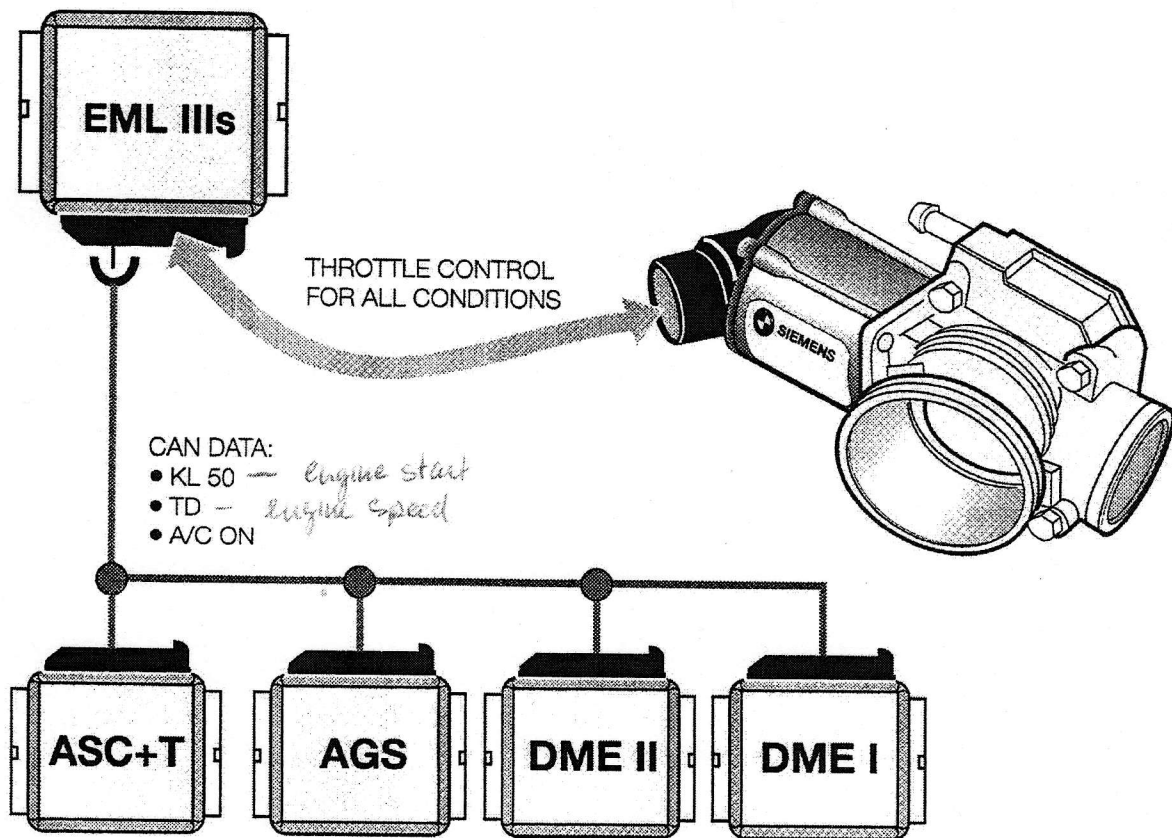

THROTTLE POSITION SENSOR (PWG)

The throttle position sensor uses an inductive coil "oscillator" principle for accelerator position recognition input. The PWG consists of:

- Three separate inductive coils.
- One soft iron core eccentric, attached to the accelerator pedal through the PWG shaft.
- One 4° switch, for the external safety path function.

Each coil is supplied with an AC voltage signal, at a specific frequency, from the EML III's control module. As the pedal is moved, the eccentric shape of the iron core moves closer to the PWG coils.

This causes the inductance of the coils to increase due to the concentration of the magnetic field.

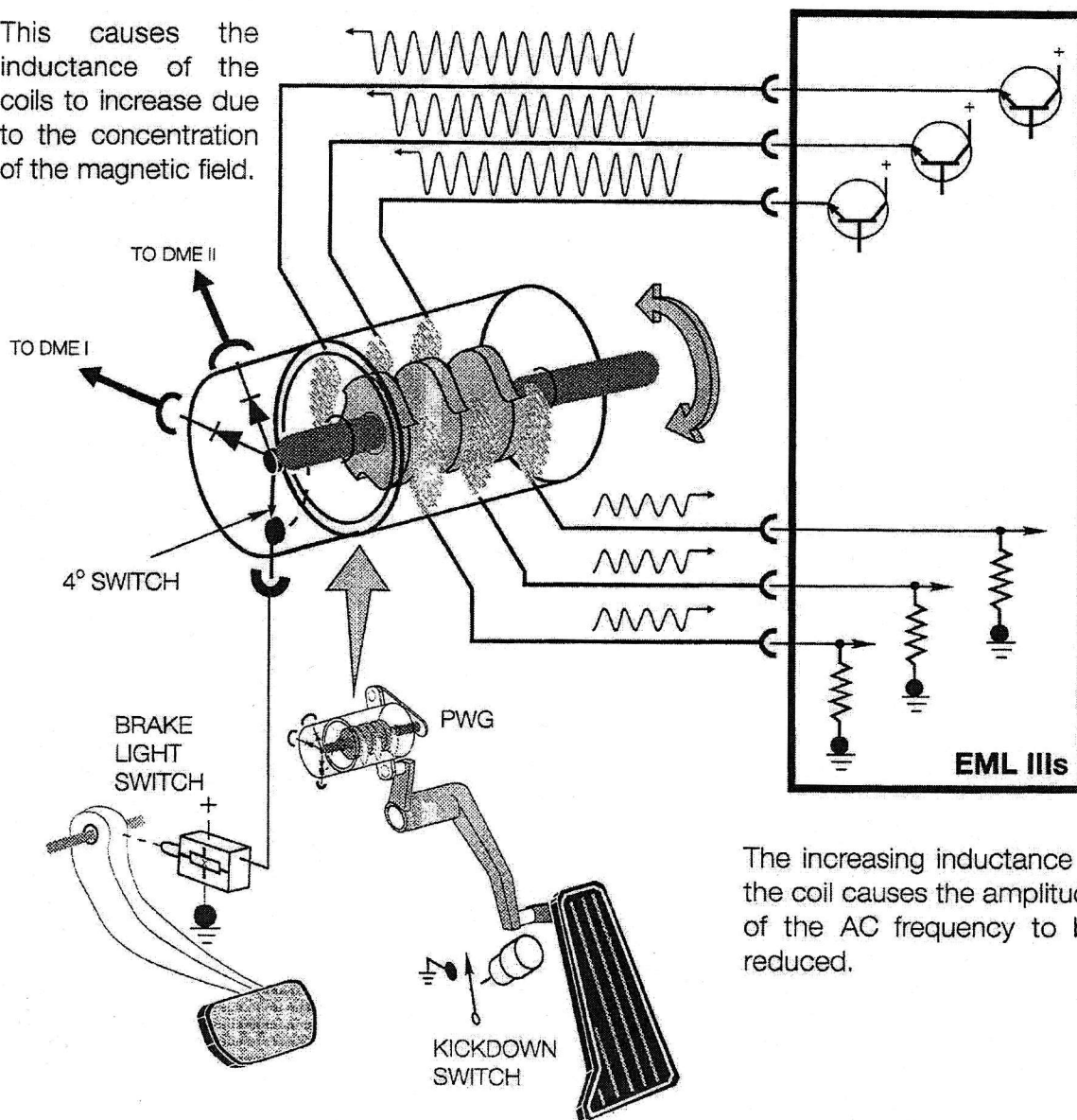

The increasing inductance in the coil causes the amplitude of the AC frequency to be reduced.

The amplitude is decreased linearly as the pedal is pressed down.

The EML control module monitors and processes the changing amplitude as the input request for throttle opening/closing.

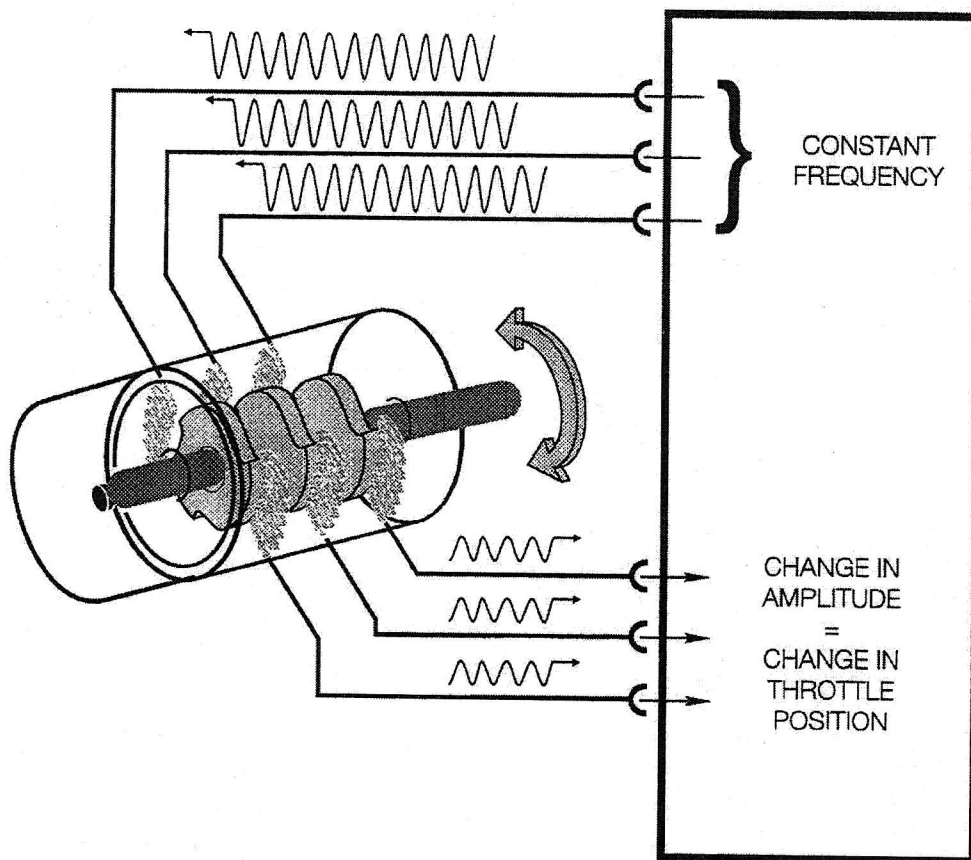

The changing amplitude value is a measure of accelerator pedal movement. The EML control module is programmed to recognize pedal movement from 0° (idle) to 99° (WOT) based on the changing voltage signal.

The three inductive coils are used for redundancy purposes. All three signals from the PWG are input and evaluated by both processors of the EML III's control module.

If one signal were to fail, the operation of the EML system, from the driver's perspective, would not be affected. The EML III's control module would continue to function from the remaining two signals. The fault will be recognized and stored in the fault memory and a failure warning message would be posted in the display matrix. If a second signal were to fail, the system would go into the failsafe operation and the EML III's control module would stop responding to the throttle input. The engine will start but not run above idle. This second fault would also be stored in the fault memory.

EXTERNAL SAFETY PATH

The external safety path circuit is maintained to ensure that the decel fuel cutoff is activated if a fault occurs with the output control of the throttle motors causing the engine not to return to idle.

The external safety path exists from the electronic brake light switch, through the 4° switch, to the decel fuel cutoff inputs of the DME control modules.

With the accelerator pedal released (4° switch closed) and the brake pedal pressed, a high signal is supplied (bypassing the EML control module) to the DME control modules to activate decel fuel cutoff.

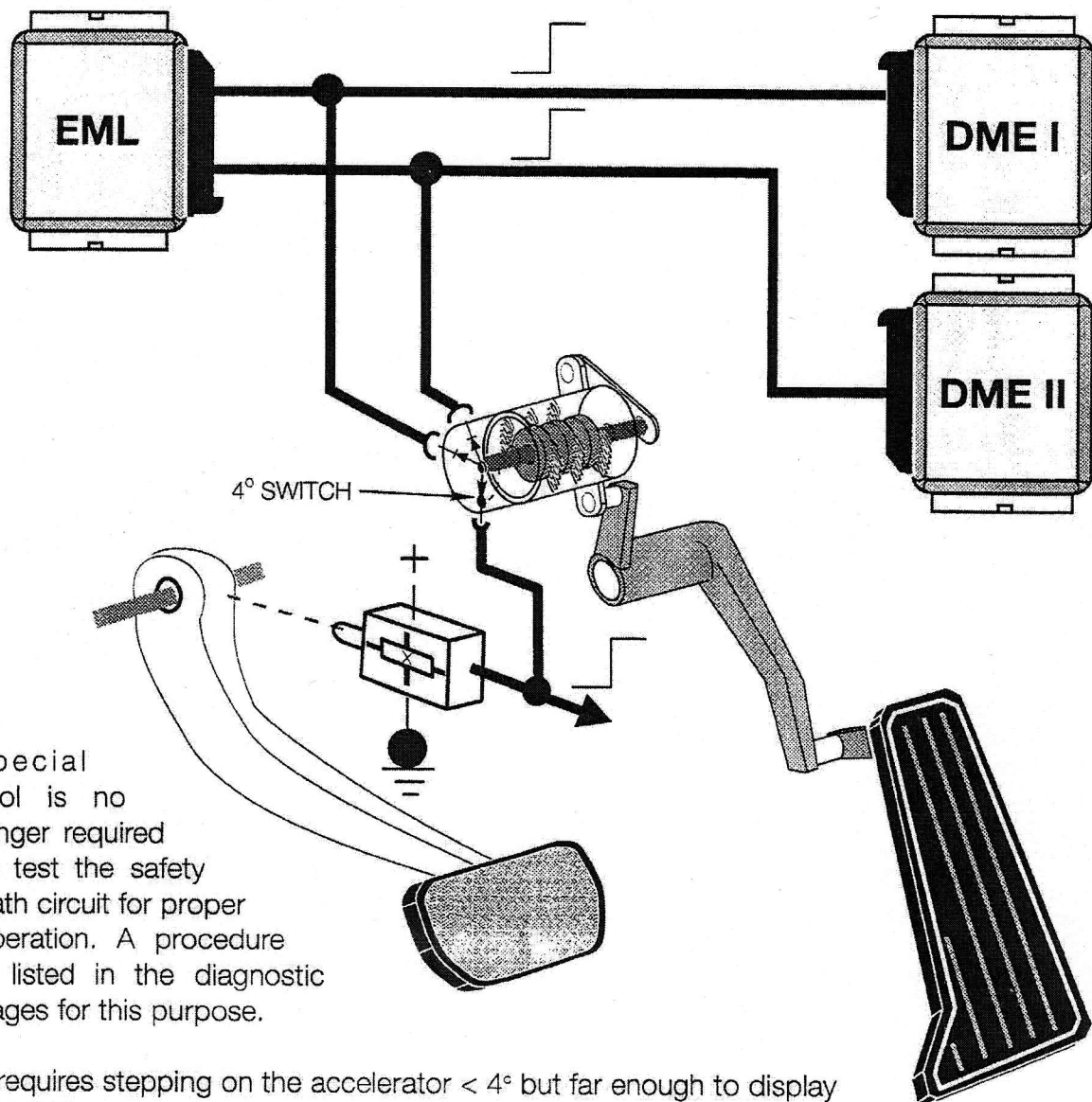

A special tool is no longer required to test the safety path circuit for proper operation. A procedure is listed in the diagnostic pages for this purpose.

It requires stepping on the accelerator < 4° but far enough to display an off idle condition. With this displayed on the DIS screen, stepping on the brake pedal will display the decel fuel cut off request to the DME.

EML III S CONTROL MODULE

The EML IIIs control module is located in the E-Box. All control and safety monitoring functions of the EML are backed up by redundant processing. Each pair of the output control final stages of the DK motors is controlled by a separate processor.

The EML control module communicates with the DME, ASC+T and EGS control modules over the CAN line for the following inputs/outputs:

DME Control Modules

- Engine coolant temperature
- Throttle position
- A/C status (ON/OFF)
- Load signal (ti) for each DME
- Engine speed (TD)

ASC+T Control Module

- Throttle valve angle
- Throttle valve increase
- Throttle valve decrease
- Vehicle speed

AGS Control Module

- Kickdown
- Transmission range/program
- Shift Characteristics

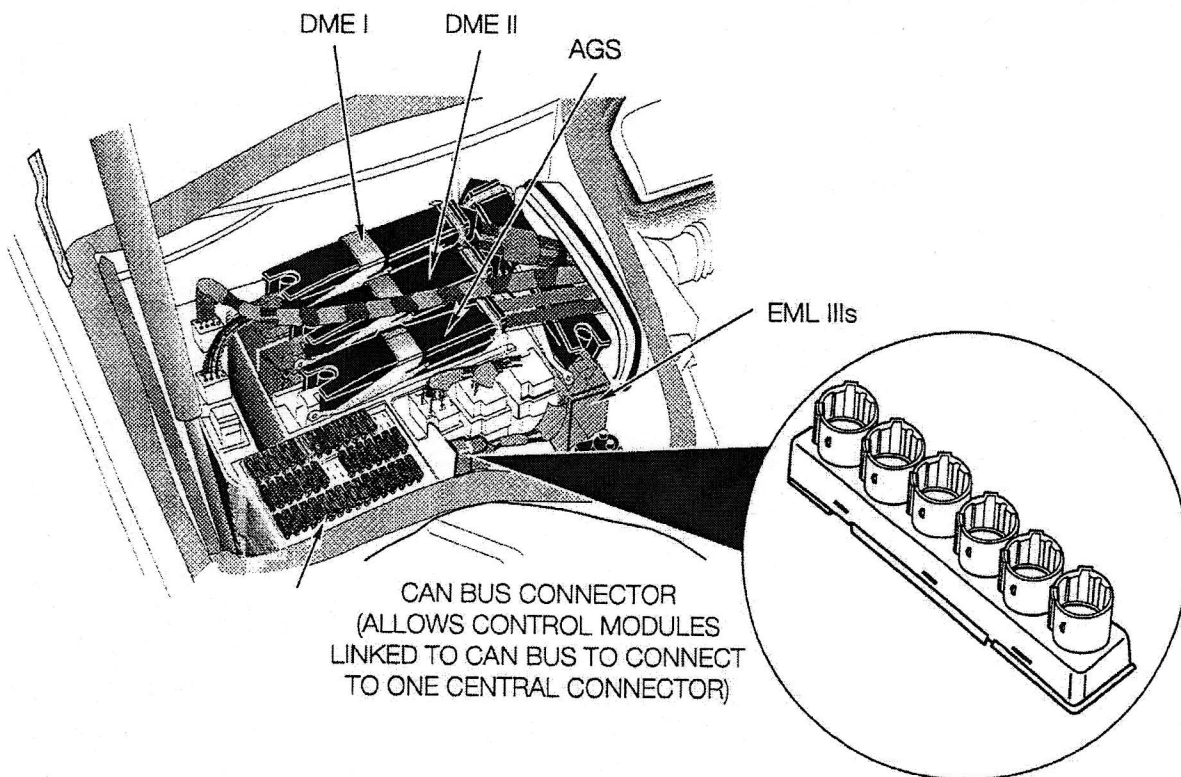

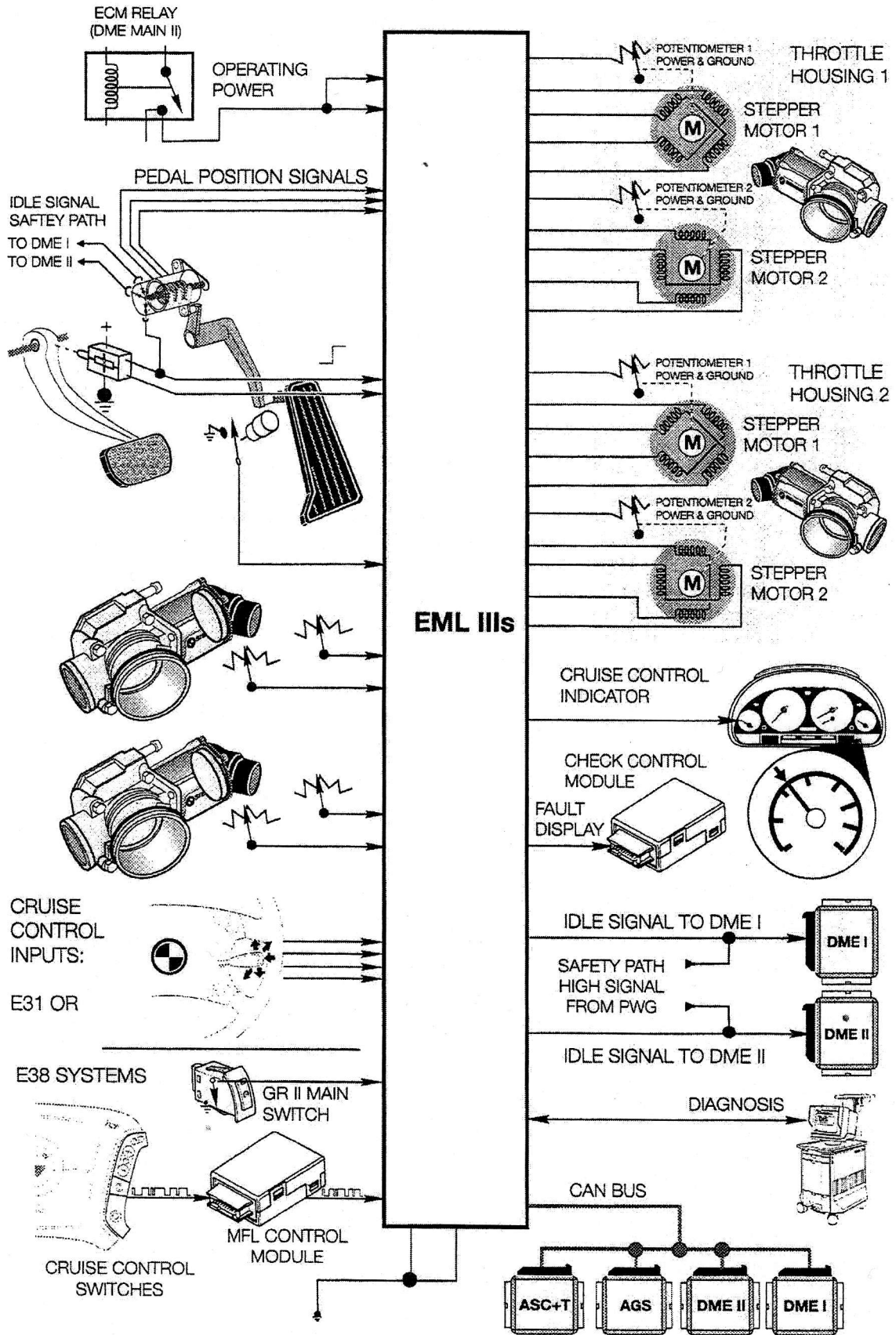

CRUISE CONTROL OPERATION

All functions of the cruise control system are incorporated in the EML III's control module. The cruise control main switch is wired directly to the EML III's control module. The multi-function steering wheel inputs are direct to the EML through a separate serial data bus.

The EML control module regulates the operation of the cruise control by regulating the position of the throttle valves as it did in the past. The new cruise control logic adopted with the GR II E38 740I are incorporated in the EML control logic.

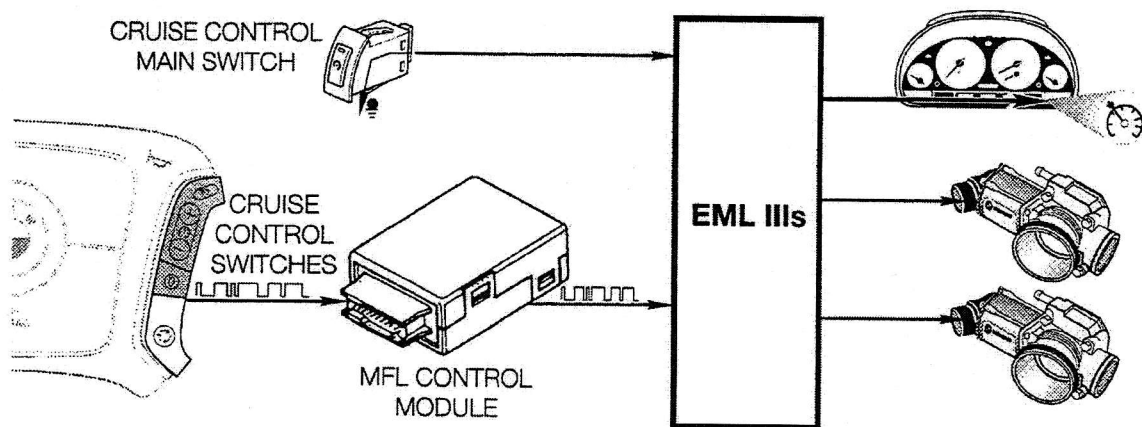

The EML controls the cruise control indicator lamp in the instrument cluster. When the main switch is pressed, the indicator lamp is illuminated.

The switching "OFF" priorities for cruise operation are carried over from the GR II system. The commands for cruise control operation are carried out according to the highest priority as follows:

- | | |
|-------------------------------|----------------------------------|
| 5 - brake light switch - | directly from EML control module |
| 4 - transmission in neutral - | from AGS control module over CAN |
| 3 - "OFF" request - | from MFL steering wheel |
| 2 - Set/Accelerate - | from MFL steering wheel |
| 1 - Resume - | from MFL steering wheel |

The new logic incorporated into the cruise control include:

- Smoother acceleration under the Resume feature.
- Downshift on decel (down hill) to provide engine braking effect.

CYLINDER BANK SYNCHRONIZATION

The throttle valves are synchronized automatically on the EML III system. This ensures that both cylinder banks receive the same air charge and creates a smooth running engine. The synchronization takes place at an idle during the purge system shut off time. The synchronization process last approx. 100 seconds.

The total conditions for synchronization to take place are:

- Idling
- Engine speed between 560 - 720 RPM
- Throttle valve stops recognized (DK idle position)
- Load difference side-to-side no more than .04 to 10 %
- No faults in DME/EML control modules
- Purge system shut down

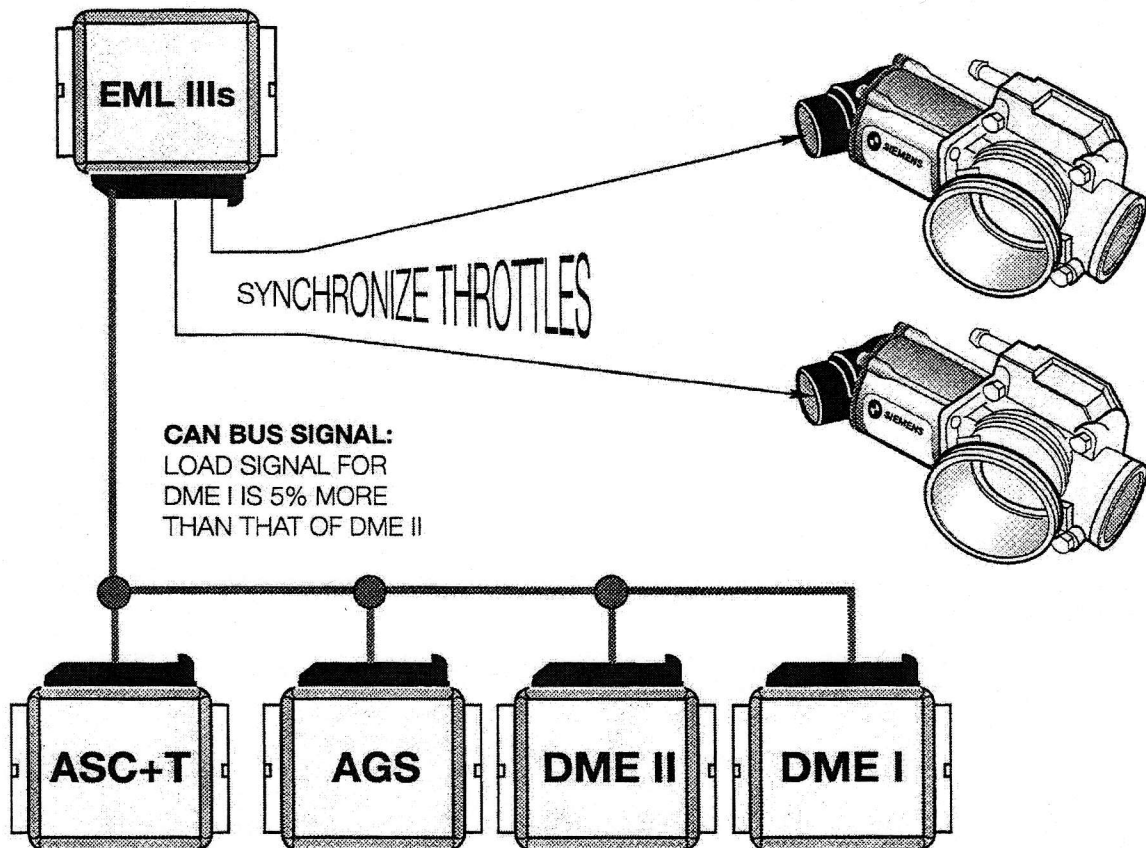

The EML control module processes the load signals from the two DME control modules. If a difference exists, the EML will adjust the DK motors to achieve equal air throughput on both banks.

If the load difference is greater than 10%, the synchronization will not take place and a fault is stored in the memory.

FAULT RECOGNITION/DIAGNOSIS

The OBD II regulations require that any fault with the EML III's system that can affect emissions must turn on the "Check Engine Lamp" and be accessible through the OBD II read out connector. These faults will also be stored in the fault memory of the EML III's control module for access through the DIS test programs.

The failure warning of the EML III's system is through the check control system (CCM) of the E38. A fault message from the EML control module is sent to the CCM and the message will be posted in the matrix display of the instrument cluster.

The diagnosis program of the DIS includes the "Fault Symptom" troubleshooting paths as well as the Test Modules, Service Functions and Expert Modes introduced with the E38 740i.

Diagnosis and troubleshooting should always begin with the fault symptom troubleshooting mode. Follow the test modules and diagnostic path provided by the DIS Tester.

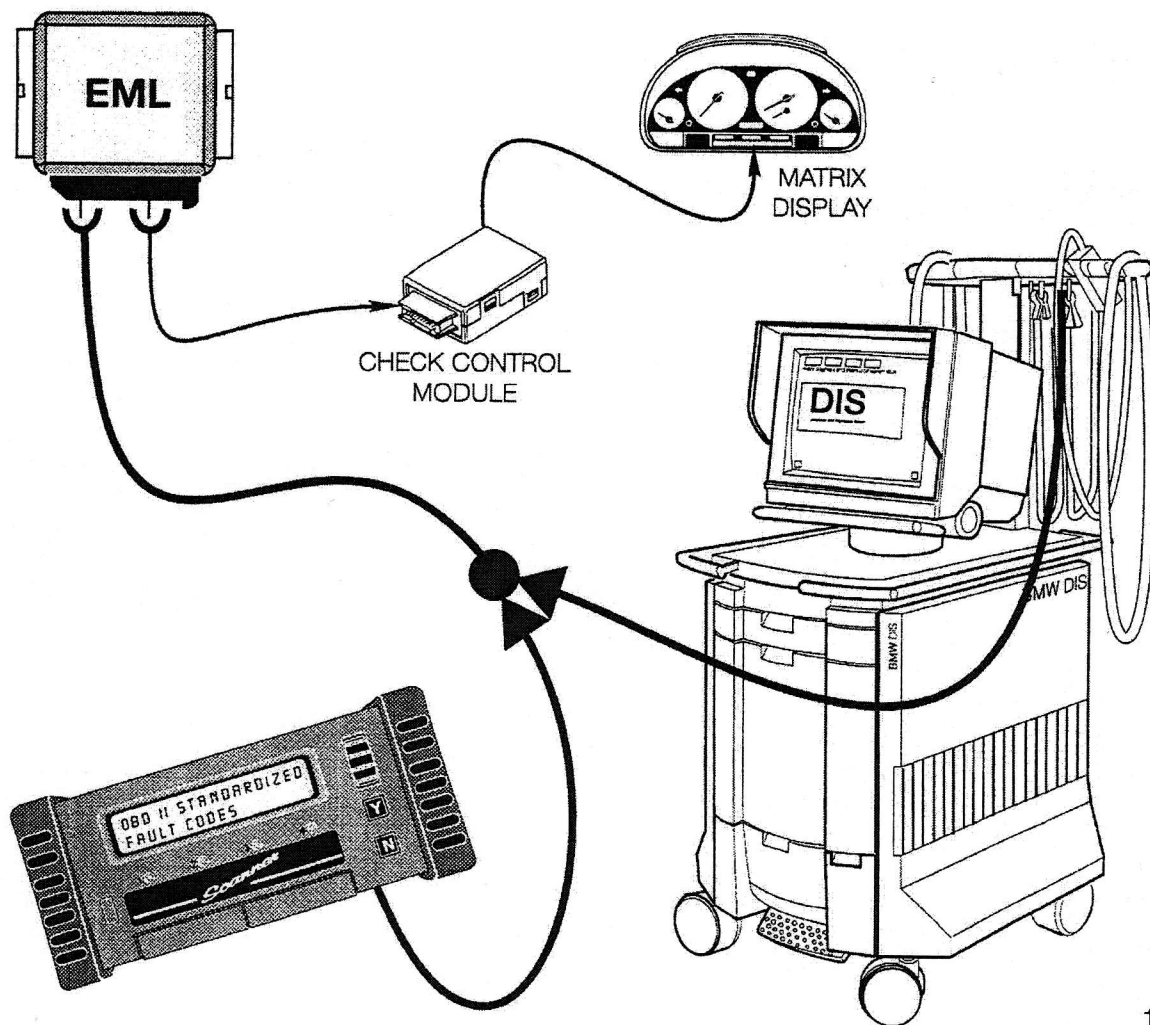

BASIC TROUBLESHOOTING

- Always personally verify the customer complaint.
- Perform a Quick Test to determine if the vehicle systems have logged fault codes.
- Call up the faulted system or appropriate test schedule to verify the correct control module is installed in the car.
- Follow the Diagnostic Information System (DIS) on screen instructions and perform all tests as specified.
- Use the DIS and fault symptom diagnostic procedures as trained.
- Follow the appropriate test module procedures for systems that malfunction but fail to set faults in memory.
- System problems which elude diagnostic procedures must be brought to the attention of BMW of North America, Inc.
- **BMW Technical Assistance Hotline 1-800-472-7222**