

ECLIPSE

ELECTRICAL WIRING

FOREWORD

This Electrical Wiring Manual contains information necessary for inspection and servicing of electrical wiring of Mitsubishi ECLIPSE edited in the form of wiring harness configuration diagrams and function-separated circuit diagrams. It is recommended that all service mechanics engaged in the servicing of the vehicle refer to the following publications as well as this manual.

TECHNICAL INFORMATION MANUAL

WORKSHOP MANUAL
CHASSIS GROUP
BODY REPAIR MANUAL

ENGINE GROUP
(Looseleaf edition)

PARTS CATALOGUE

All information, illustrations and product descriptions contained in this manual are current as of time of publication. We, however, reserve the right to make changes at any time without prior notice or obligation.

 **MITSUBISHI MOTOR SALES**
Europe B.V.

GROUP INDEX

00109000225

HOW TO READ THE WIRING DIAGRAMS	1
WIRING HARNESS CONFIGURATION DIAGRAMS	2
SINGLE PART INSTALLATION POSITION	3
CIRCUIT DIAGRAMS	4
INDEX	

HOW TO USE THIS MANUAL

00100010104

CONTENTS

The preceding page contains GROUP INDEX that lists the group title and group number.

PAGE NUMBERS

All page numbers consist of two sets of digits separated by a dash. The digits preceding the dash identify the number of the group. The digits following the dash represent the consecutive page number within the group. The page number can be found on the top left or right of each page.

OPERATION AND TROUBLESHOOTING HINTS

In the GROUP 4 circuit diagrams, the operation and troubleshooting hints are given on the previous page or following page for each circuit where necessary.

1 HOW TO READ THE WIRING DIAGRAMS

00109000232

MODELS	1-2	MARKINGS FOR CONNECTOR	
COMPOSITION AND CONTENTS OF		EARTHING	1-6
WIRING DIAGRAMS	1-2	WIRE COLOUR CODES	1-9
HOW TO READ CONFIGURATION		ABBREVIATION SYMBOLS	1-10
DIAGRAMS	1-3		
HOW TO READ CIRCUIT DIAGRAMS	1-4		

MODELS

00100030124

Model code		Engine model	Transmission model	Fuel supply system
D32A	MNHSLF6	4G63-DOHC (1,997mℓ)	F5M31 (2WD-5M/T)	MPI

COMPOSITION AND CONTENTS OF WIRING DIAGRAMS

00100010111

- (1) This manual consists of wiring harness diagrams, installation locations of individual parts, circuits diagrams and index.
- (2) In each section, all specifications are listed, including optional specifications. Accordingly, some specifications may not be applicable for individual vehicles.

Section	Basic contents
Wiring harness configuration diagrams	Connector locations and harness wiring configurations on actual vehicles are illustrated.
Single part installation position	Locations are shown for each point of relays, electronic control units, sensors, solenoids, solenoid valves, diodes, inspection connectors, spare connectors, fusible links, fuses, etc. In the part's lists, parts are listed in alphabetical order.
Circuit diagrams	<p>Circuits from power supply to earth are shown completely, classified according to system. There is a main division into power circuits, and circuits classified by system. The circuits classified by system also include operation and troubleshooting hints.</p> <ul style="list-style-type: none"> ● Junction block The entire circuit for the junction block is described, because only the part of the junction block needed is normally shown in each circuit diagram. ● Joint connectors The internal circuits for all joint connectors are described, because only the part needed is shown in each circuit diagram. ● Power supply circuits Circuits from the battery to fusible link, dedicated fuses, ignition switch, general purpose fuses, etc. ● Circuits classified by system For each system, the circuits are shown from fuse to earth, excluding the power supply sections. ● Operation The standard operation of each system is briefly described, following the route of current flow. ● Troubleshooting hints This is a brief explanation of the inspection points that serve as hints when troubleshooting. Explanations of the circuits controlled by the electronic control unit are omitted. Refer to the related publications as required.
Index	All components used are listed by connector number and component name.

HOW TO READ CONFIGURATION DIAGRAMS

80100020109

The wiring harness diagrams clearly show the connector locations and harness routings at each site on actual vehicles.

Denotes connector No.
The same connector No. is used throughout the circuit diagrams to facilitate connector location searches.
The first alphabetical symbol indicates the location site of the connector and a number that follows is the unique number. Numbers are assigned to parts in clockwise order on the diagram.
In addition, the number of connector pins and the connector colour (except milk white)* are shown for ease of retrieval.

Example: A-12 (2-B)

- Connector colour (milk white if no colour is indicated)
- Number of connector pins
- Number specific to connector (serial number)
- Connector location site symbol
- A: Engine compartment
- B: Dash panel
- C: Instrument panel and floor console
- D: Door
- E: Interior

*: Typical connector colours

- B: Black
- Y: Yellow
- L: Blue
- G: Green
- R: Red
- BR: Brown
- V: Violet
- O: Orange
- GR: Gray
- DG: Dark gray

Denotes earth point.
Same earth number is used throughout circuit diagrams to facilitate search of earth point. Refer to GROUP 3 SINGLE PART INSTALLATION POSITION - EARTH MOUNTING LOCATIONS for details of earth points.

Denotes a section covered by a corrugated tube.

The mark ★ shows the standard mounting position of wiring harness.

Indicates the device to which the connector is to be connected.

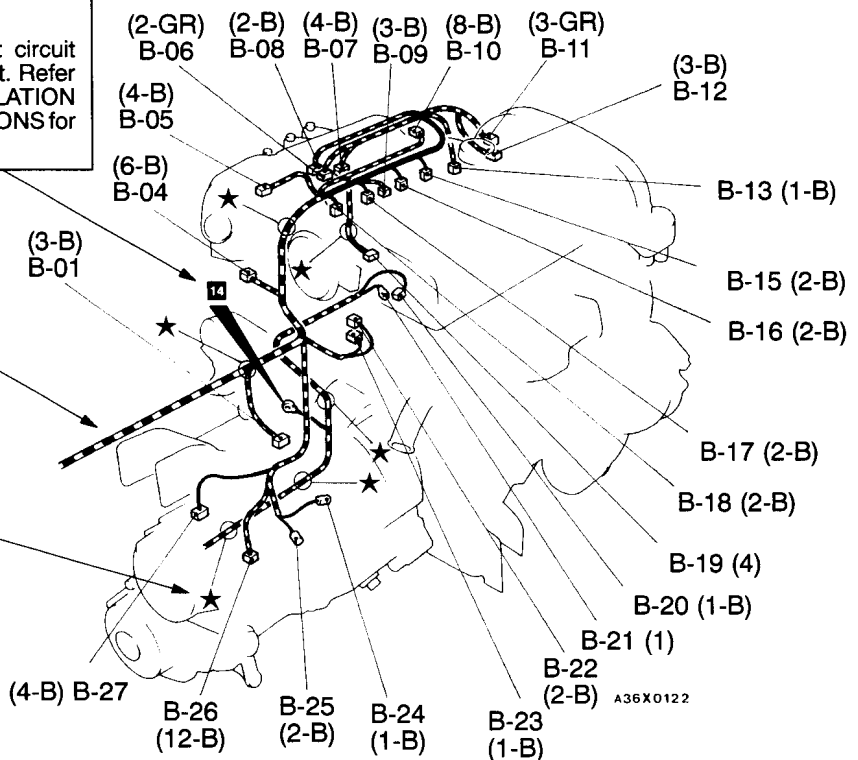

- | | | | |
|------|--------------------------|------|-----------------------|
| B-01 | Vehicle speed sensor | B-16 | Injector No. 2 |
| B-02 | Distributor assembly | B-17 | Injector No. 3 |
| B-03 | Distributor assembly | B-18 | Injector No. 4 |
| B-04 | Idle speed control servo | B-19 | Oxygen sensor (front) |
| B-05 | Throttle position sensor | B-20 | Starter motor |

HOW TO READ CIRCUIT DIAGRAMS

90100010099

The circuit of each system from fuse (or fusible link) to earth is shown. The power supply is shown at the top and the earth at the bottom to facilitate understanding of the current flow.

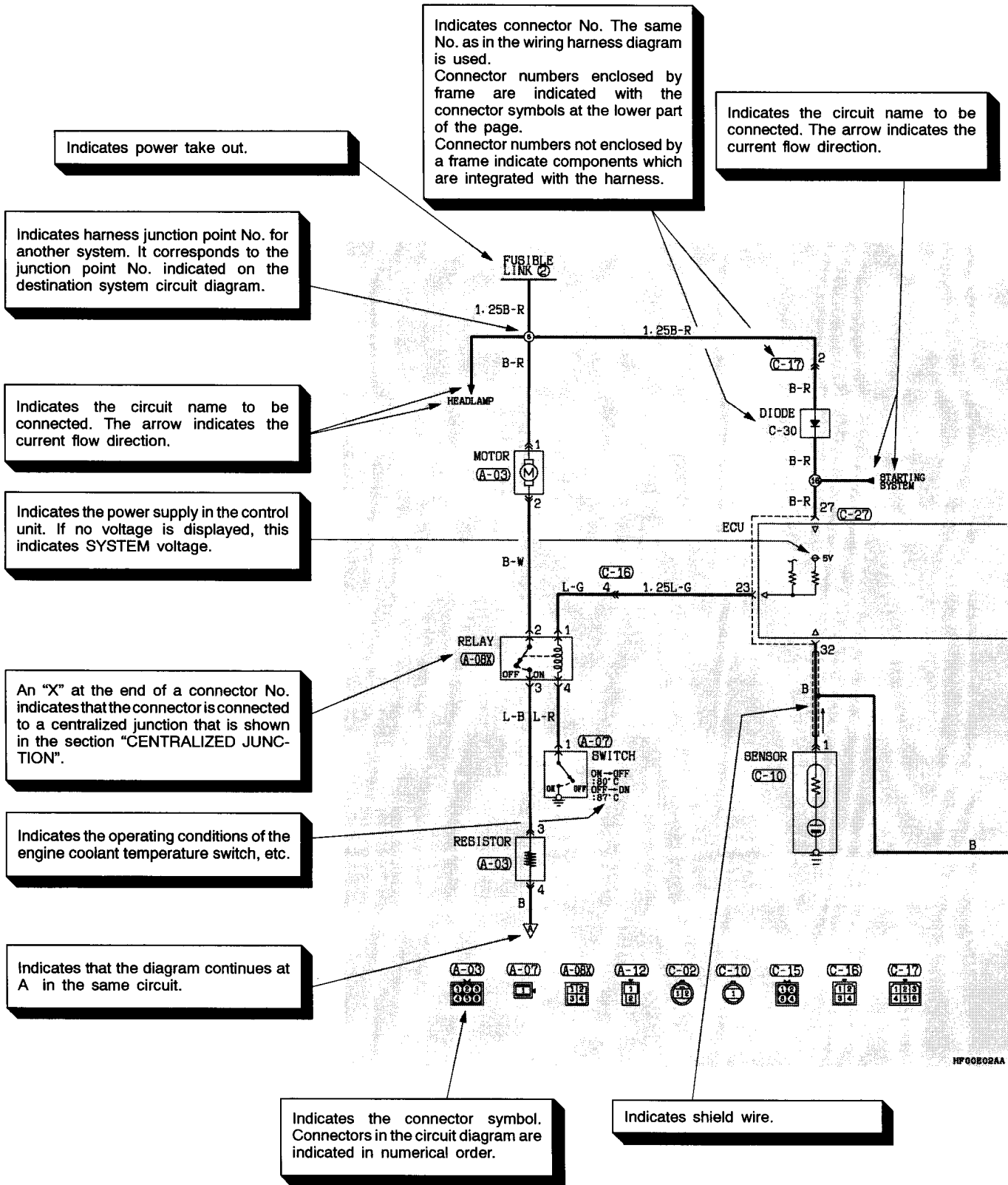

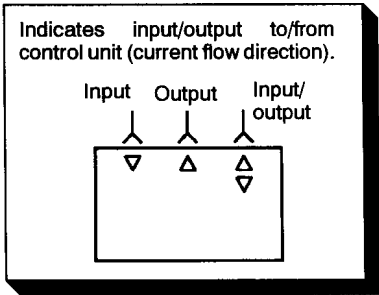

A broken line indicates that these connectors are the same intermediate connectors.

Indicates that the diagram comes from A in the same circuit.

Indicates terminal No.

In case two or more connectors are connected to the same device, markings indicating the same connectors are connected by a broken line.

Indicates current flow downwards or upwards as controlled by the control unit.

Indicates harness junction where wire diameter or colour changes.

Indicates intersections at which the lead wire are not connected.

Indicates intersections at which the lead wires are connected.

Indicates vehicle body earth point. (Same No. as that of earth point in wiring harness diagram and installation locations of individual parts.)

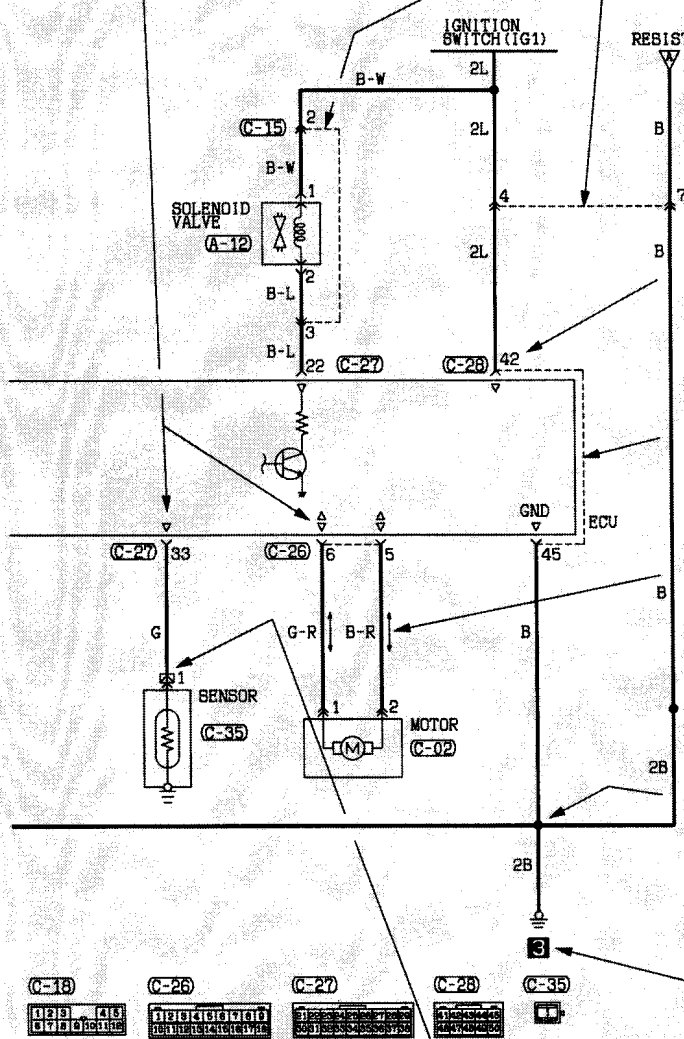

Indicates that the terminal is a spare one if the device (sensors in this case) is not provided.





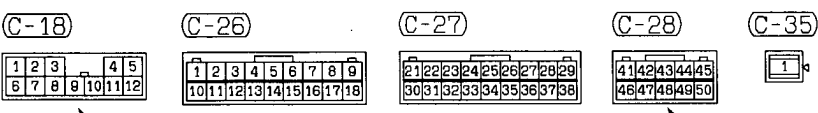
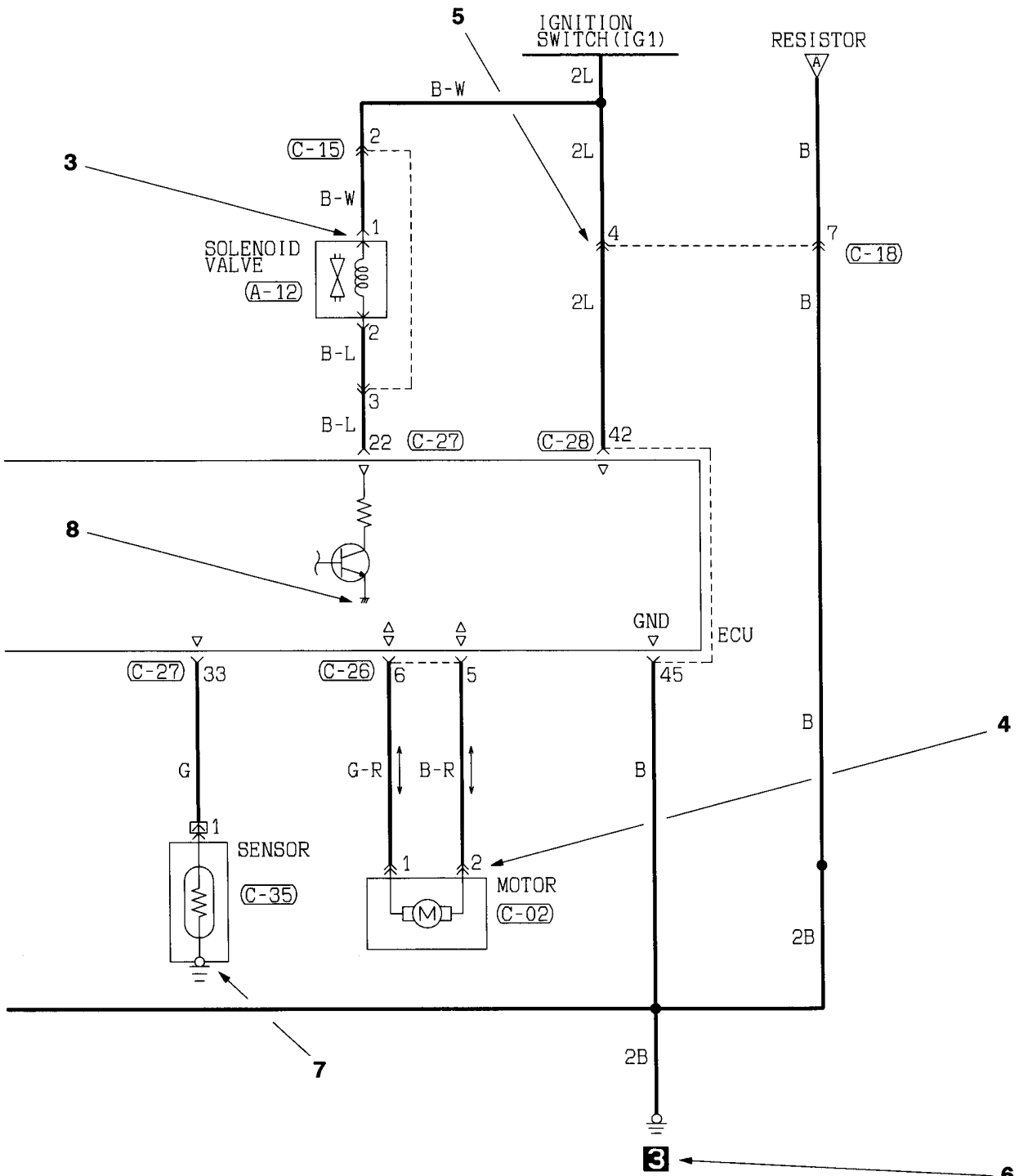

HF00802AB



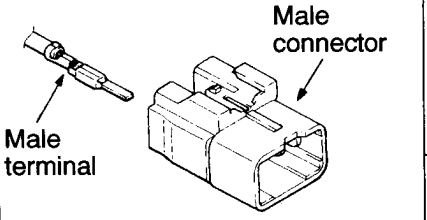

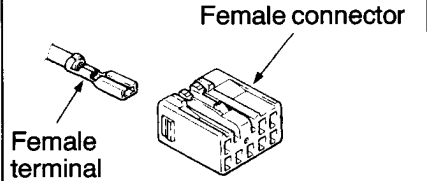

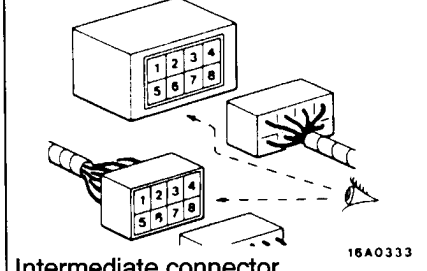
MARKINGS FOR CONNECTOR EARTHING

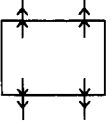
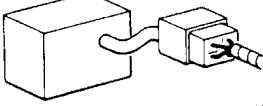
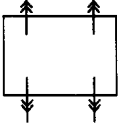
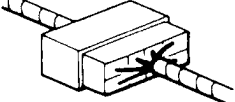

1

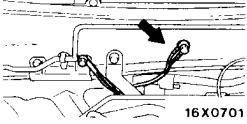
2

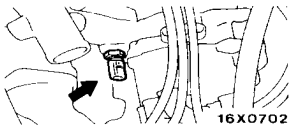
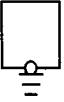
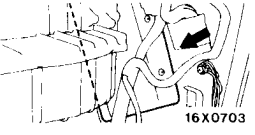
Item	No.	Connector/Earthing	Symbol	Contents
Connector and terminal marking	1	 <p>Male terminal</p> <p>Male connector</p> <p>A16R0001</p>	<p>Male terminal</p>  <p>Male connector</p> 	<p>The male and female terminals are indicated as shown. The connector with male terminal(s) is called as male connector and indicated by double-connector contour lines, while the connector with female terminal(s) is called as female connector and indicated by single-connector contour line.</p>
	-	 <p>Female terminal</p> <p>Female connector</p> <p>A16R0002</p>	<p>Female terminal</p>  <p>Female connector</p> 	
Connector symbol marking	2	<p>Device</p>  <p>Intermediate connector</p> <p>16A0333</p>		<p>The symbol indicates the connector as viewed from illustrated direction. At the connection with a device, the connector symbol on the device side is shown, and for an intermediate connector, male connector symbol is shown. For the diagnosis connector, its contents differ from the previous description. Refer to "MUT-II operation instruction" in detail.</p>

Item	No.	Connector/Earthing	Symbol	Contents
Connector connection marking	3	Direct connection type  <small>16X0700</small>		A connection between a device and connector on the harness side is either by direct insertion in the device (direct connection type) or by connection with a harness connector on the device side furnished (harness connection type). The two types are indicated as illustrated.
	4	Harness connection type  <small>16A0334</small>		
	5	Intermediate connector  <small>16A0339</small>		
Earth markings	6	Body earth  <small>16X0701</small>		Earth is either by body earth, device earth or control unit interior earth. These are indicated as illustrated.
	7	Device earth  <small>16X0702</small>		
	8	Earth in control unit  <small>16X0703</small>		

WIRE COLOUR CODES

Wire colours are identified by the follow colour codes.

Code	Wire colour	Code	Wire colour
B	Black	P	Pink
BR	Brown	R	Red
G	Green	SB	Sky blue
GR	Gray	SI	Silver
L	Blue	V	Violet
LG	Light green	W	White
O	Orange	Y	Yellow

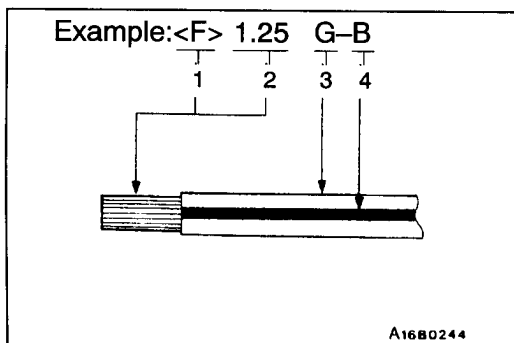

If a cable has two colours, the first of the two colour code characters indicates the basic colour (colour of the cable coating) and the second indicates the marking colour

No.	Meaning
1	<F>:Flexible wire
	<T>:Twisted wire
2	Wire size(mm ²)*
3	Basic colour (colour of the cable coating)
4	Marking colour

NOTE

*: No code indicates 0.5 mm² (.0008 in²).
Cable colour code in parentheses indicates 0.3 mm² (.0005 in²).

1-10 HOW TO READ THE WIRING DIAGRAMS – Abbreviation Symbols

ABBREVIATION SYMBOLS

1. Abbreviation symbols used for wiring harness

Abbreviation symbol	Meaning	Abbreviation symbol	Meaning
ABS	Anti-skid braking system	ILL	Illumination lamp
A/C	Air conditioner	IND	Indicator lamp
DRL	Daytime running lamp	J/B	Junction block
ECU	Electronic control unit	J/C	Joint connector
EGR	Exhaust gas recirculation	LH	Left hand
ETACS	Electronic time and alarm control system	MPI	Multi-point injection
		RH	Right hand
GND	Earth	SRS	Supplemental restraint system

2. Abbreviation symbols used for combination meters

Abbreviation symbol	Meaning	Abbreviation symbol	Meaning
ABS	Anti-skid braking system warning lamp	OIL	Oil pressure warning lamp
BEAM	High-beam indicator lamp	OIL LEVEL	Engine oil level warning lamp
BRAKE	Brake warning lamp	R/FOG	Rear fog lamp indicator lamp
CHECK ENGINE	Check engine warning lamp	SPEED	Speedometer
CHG	Charging warning lamp	SRS	Supplemental restraint system warning lamp
CRUISE	Auto-cruise control system warning lamp	TACHO	Tachometer
DOOR	Door-ajar warning lamp	T/GA	Engine coolant temperature gauge
F/GA	Fuel gauge	TURN (LH)	Turn signal indicator lamp (L.H.)
FUEL	Low-fuel warning lamp	TURN (RH)	Turn signal indicator lamp (R.H.)
ILL	Illumination lamp	WASHER	Washer fluid level warning lamp
O/GA	Engine oil pressure gauge		

3. Abbreviation symbols used for switches and relays

Name of switches and relays	Abbreviation symbols	Operation	Name of switches and relays	Abbreviation symbols	Operation
Ignition switch	ACC	When turned to the ACC (ACCESSORY) or ON position, the power circuit will start	Windshield wiper switch	LO	Wipers operate at low speed
	IG1	Even when at the ST (START) position, the power circuit will start		HI	Wipers operate at high speed
				INT	Wipers operate intermittently
	IG2	When at the ST (START) position, the power circuit will not start functioning	Variable intermittent wiper control switch	SLOW	Pause time for intermittent operation lengthen
Dimmer passing switch	LO	Low beams ON	Rear wiper switch	FAST	Pause time for intermittent operation shorten
	HI	High beams ON		LO	Wiper operates at low speed
Lighting switch	TAIL	Position, tail, licence plate and other illumination lamps ON	Remote controlled mirror switch	INT	Wiper operates intermittently
	HEAD	Headlamps ON		LH	L.H. mirror operates
Room lamp switch	DOOR	Room lamp ON when a door is open	Sunroof switch	RH	R.H. mirror operates
				OPEN	Sunroof tilts up or slides to open
Turn signal switch	LH	L.H. turn signal lamps ON	Power seat switch	CLOSE	Sunroof tilts down or slides to close
	RH	R.H. turn signal lamps ON		SLIDE FR	Seat is moved forwards
Power window switch	UP	Window closes	SLIDE RR	Seat is moved backwards	
	DOWN	Window opens	FRONT HEIGHT UP	Front part of seat cushion is tilted up	
	AUTO DOWN	Window is easily opened with one action	FRONT HEIGHT DOWN	Front part of seat cushion is tilted down	
Door lock actuator	LOCK	Door lock	REAR HEIGHT UP	Rear part of seat cushion is tilted up	
	UN-LOCK	Door unlock	REAR HEIGHT DOWN	Rear part of seat cushion is tilted down	
Door lock key cylinder switch	LOCK	Door lock	Others	ON	Switched on
	UN-LOCK	Door unlock		OFF	Switched off
Blower switch	LO	Blower operates at low speed			
	ML	Blower operates at medium low speed			
	MH	Blower operates at medium high speed			
	HI	Blower operates at high speed			

NOTES

2 WIRING HARNESS CONFIGURATION DIAGRAMS

80109000081

OVERALL WIRING DIAGRAM	2-3	INSTRUMENT PANEL AND FLOOR CONSOLE	2-12
ENGINE COMPARTMENT	2-4	DOOR	2-13
DASH PANEL	2-8	INTERIOR	2-14

NOTES

OVERALL WIRING DIAGRAM

80100010106

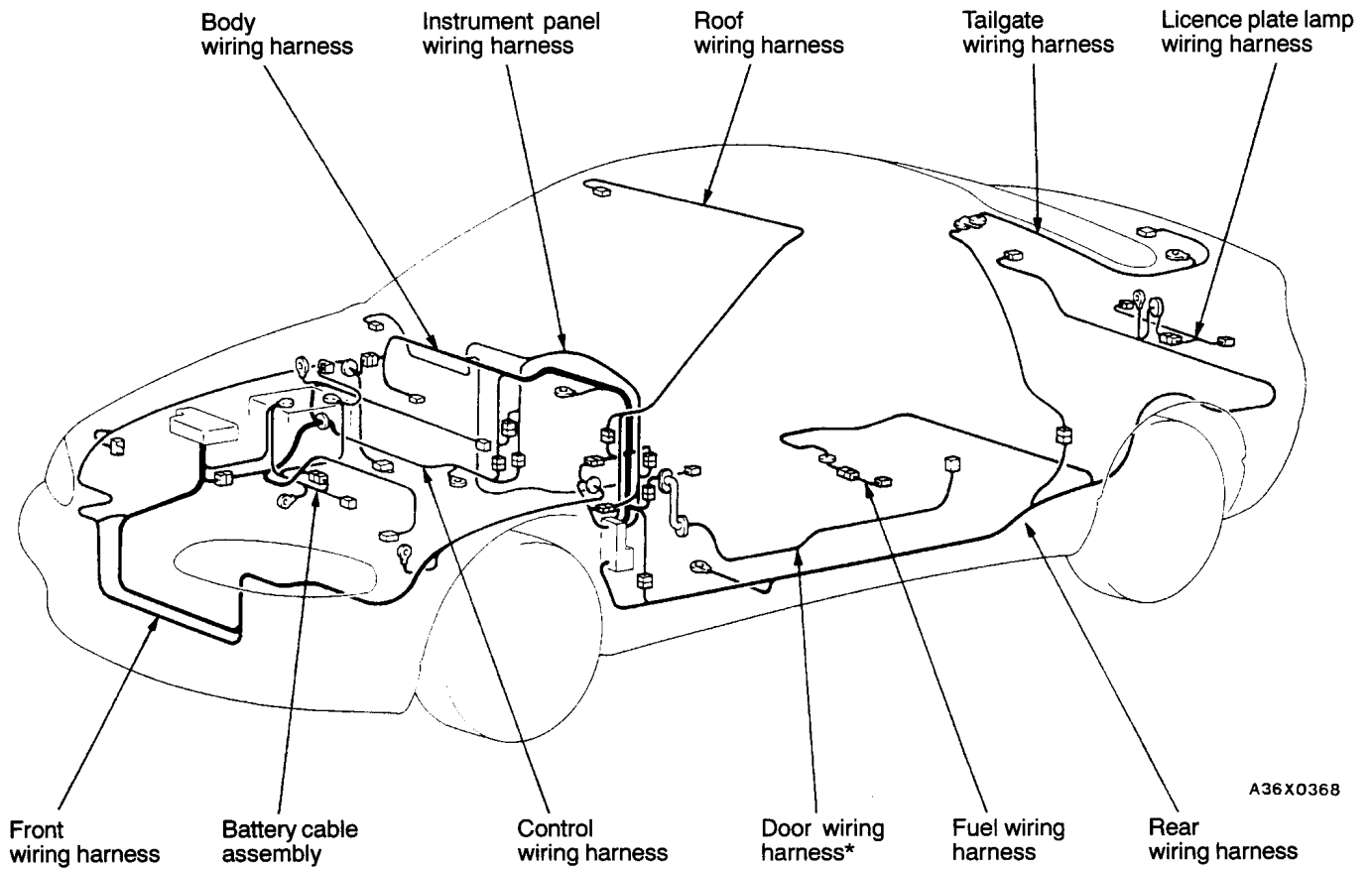

Remarks

- (1) This illustration shows only major wiring harnesses.
- (2) *: also equipped at the right side.

ENGINE COMPARTMENT

80100030454

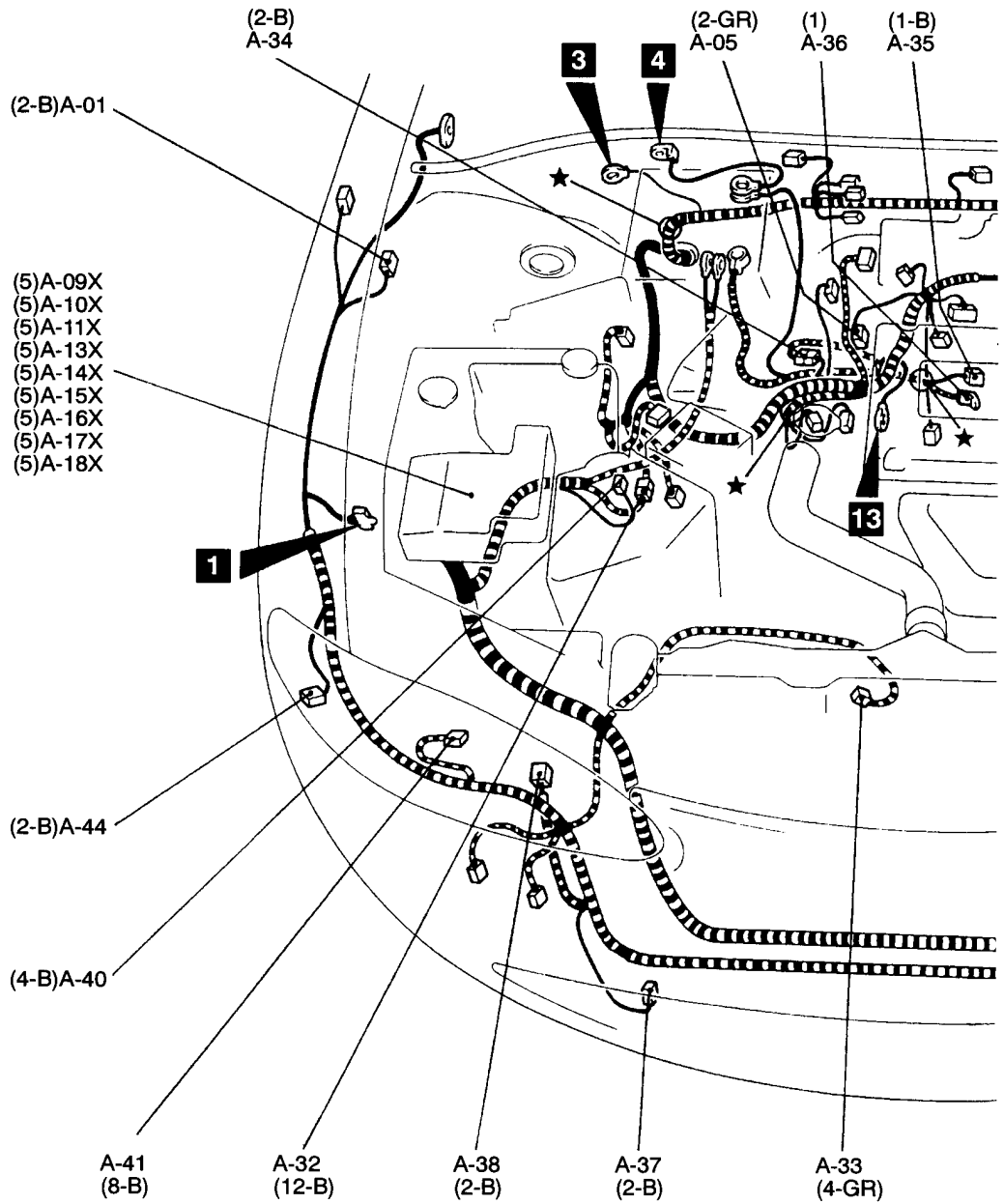
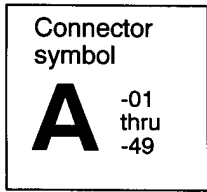

- A-01 ABS wheel-speed sensor (front:RH)
- A-02 Alternator
- A-03 Alternator
- A-04 Crankshaft position sensor
- A-05 Detonation sensor
- A-08 ABS wheel-speed sensor (front:LH)
- A-09X Condensor fan relay (LO)
- A-10X Condensor fan relay (HI)
- A-11X Radiator fan relay (LO)
- A-13X Radiator fan relay (HI)
- A-14X Headlamp relay

- A-15X Tail lamp relay
- A-16X Front fog lamp relay
- A-17X Horn relay
- A-18X A/C compressor clutch relay
- A-20 Front combination lamp (LH)
- A-23 Hydraulic unit
- A-24 Hydraulic unit
- A-25 Headlamp assembly (LH)
- A-26 Front wiring harness and joint wiring harness combination

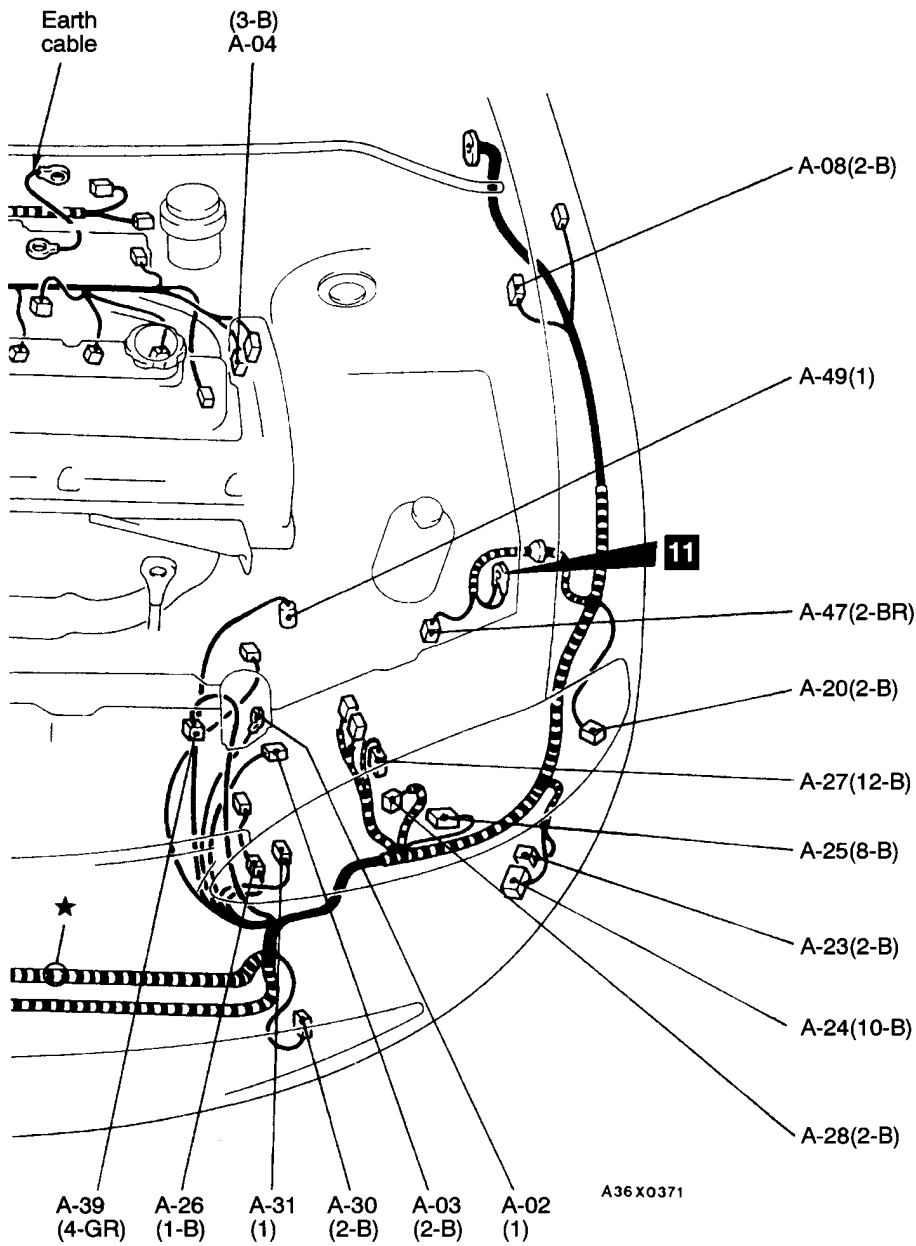

A36 X0371

- | | | | |
|------|---|------|------------------------------------|
| A-27 | DRL-ECU | A-36 | Starter motor |
| A-28 | Horn (LH) | A-37 | Front fog lamp (RH) |
| A-30 | Front fog lamp (LH) | A-38 | Horn (RH) |
| A-31 | Oil pressure switch | A-39 | Condensor fan motor |
| A-32 | Front wiring harness and control wiring harness combination | A-40 | Alternator relay |
| A-33 | Radiator fan motor | A-41 | Headlamp assembly (RH) |
| A-34 | Control wiring harness and battery cable combination | A-44 | Front combination lamp (RH) |
| A-35 | Starter motor | A-47 | Dual pressure switch |
| | | A-49 | Power steering oil pressure switch |

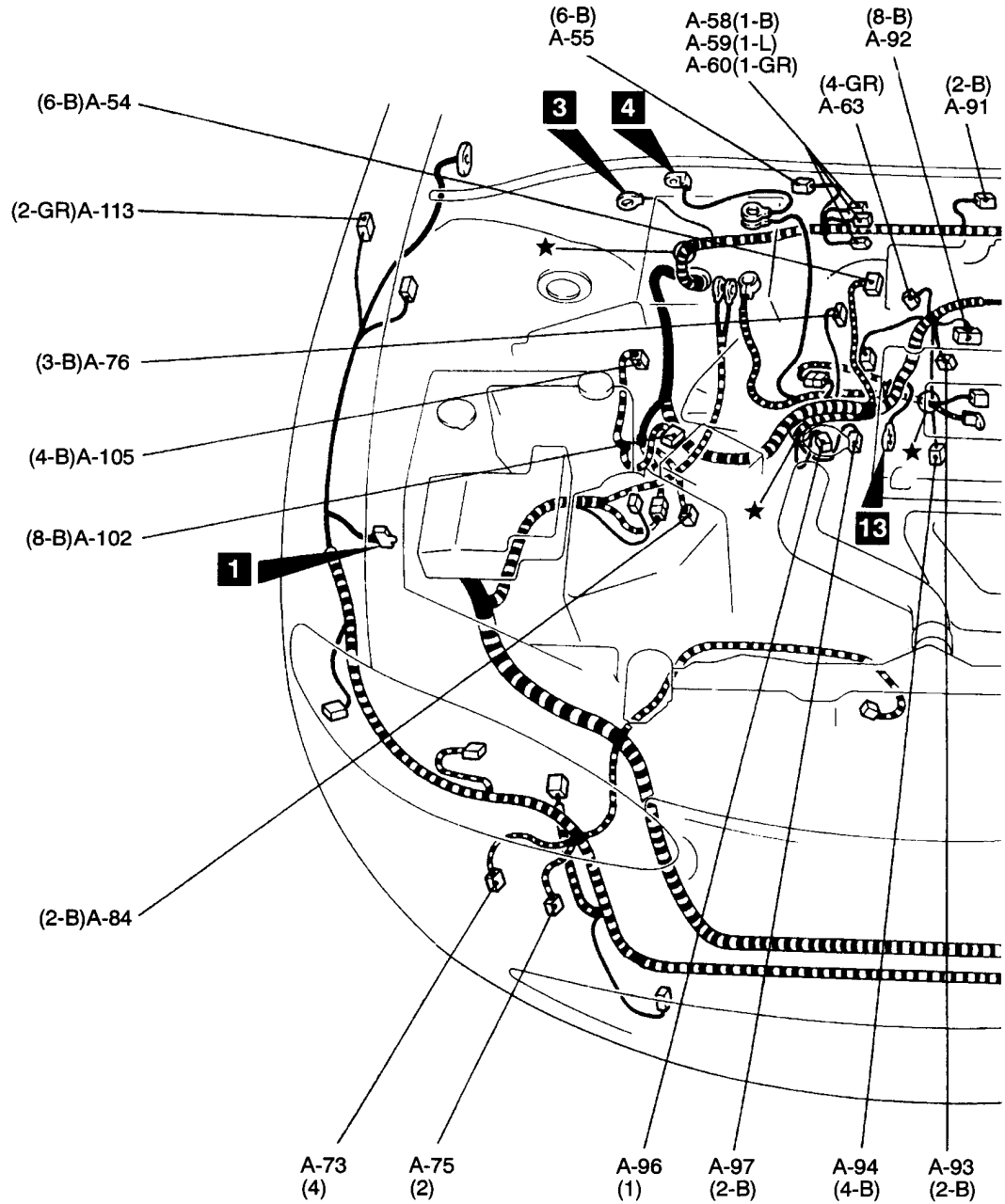
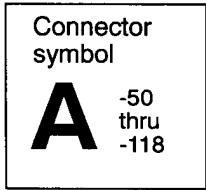

- | | | | |
|------|--------------------------------------|------|---|
| A-50 | Injector No.1 | A-63 | Throttle position sensor |
| A-54 | Idle air control motor | A-64 | Capacitor |
| A-55 | Windshield wiper motor | A-66 | Purge solenoid valve |
| A-56 | Injector No.2 | A-67 | Brake fluid level sensor |
| A-58 | Fuel pump check connector | A-73 | Windshield washer fluid level switch or headlamp washer motor |
| A-59 | Engine speed detection connector | A-75 | Windshield washer motor |
| A-60 | Ignition timing adjustment connector | A-76 | Vehicle speed sensor |
| A-61 | Injector No.3 | | |
| A-62 | Ignition coil | | |

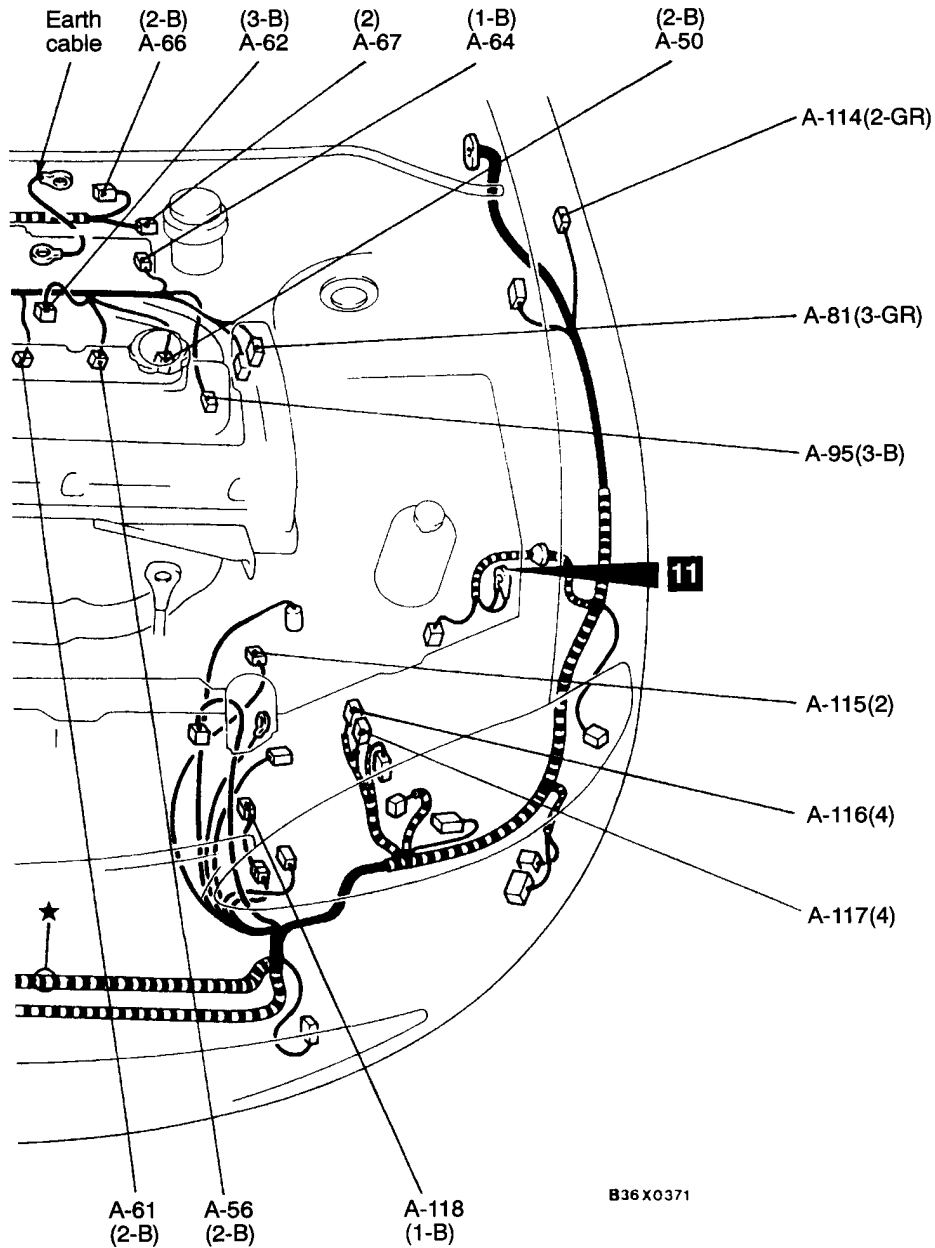

- | | | | |
|------|---------------------------------------|-------|---------------------------------|
| A-81 | Camshaft position sensor | A-102 | Air flow sensor |
| A-84 | Back-up lamp switch | A-105 | Auto-cruise control vacuum pump |
| A-91 | EGR solenoid valve | A-113 | Side turn-signal lamp (RH) |
| A-92 | Power transistor | A-114 | Side turn-signal lamp (LH) |
| A-93 | Injector No.4 | A-115 | Engine oil level sensor |
| A-94 | Oxygen sensor | A-116 | DRL relay (1) |
| A-95 | A/C compressor | A-117 | DRL relay (2) |
| A-96 | Engine coolant temperature gauge unit | A-118 | Oil pressure gauge unit |
| A-97 | Engine coolant temperature sensor | | |

DASH PANEL

80100060194

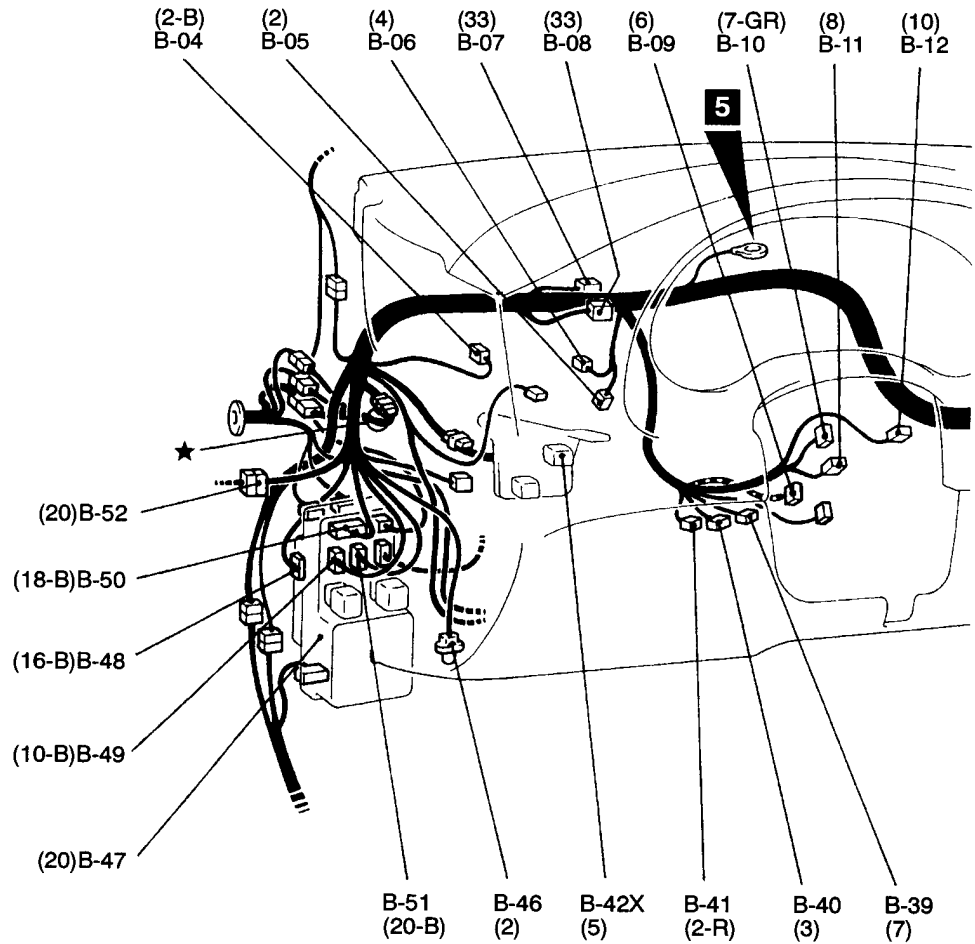
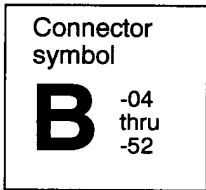

- B-04 Clutch pedal position switch
- B-05 Stop lamp switch <without auto-cruise control system> or no connection <with auto-cruise control system>
- B-06 Stop lamp switch <with auto-cruise control system> or no connection <without auto-cruise control system>
- B-07 J/C (1)
- B-08 J/C (2)
- B-09 Ignition switch
- B-10 Column switch

- B-11 Column switch
- B-12 Column switch
- B-13 Diode (for idle up circuit)
- B-15 Blower control panel illumination lamp
- B-16 Blower switch
- B-17 A/C switch
- B-18 Turn-signal and hazard flasher unit
- B-22 Blower resistor
- B-24 Blower motor
- B-25 A/C-ECU
- B-27 Body wiring harness and door wiring harness (RH) combination

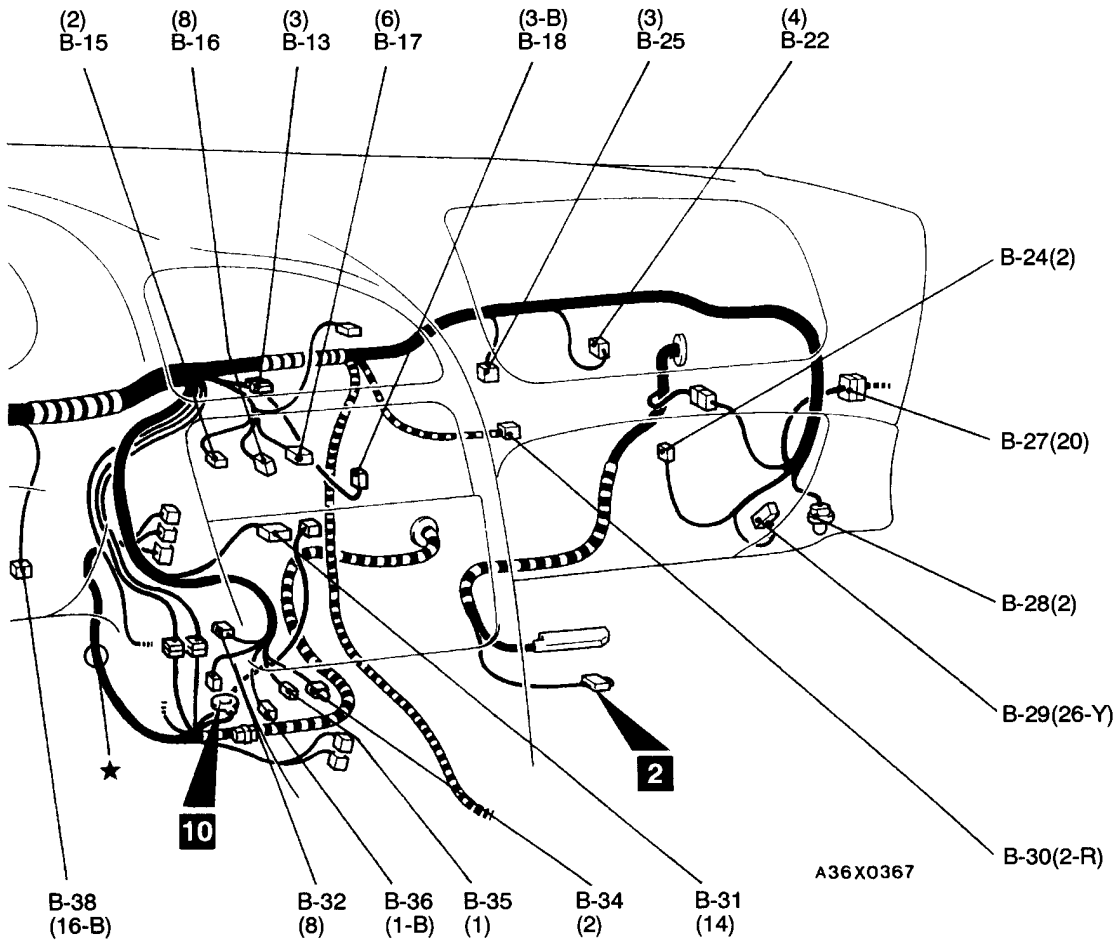

- | | | | |
|------|-------------------------------------|-------|--|
| B-28 | Foot lamp (RH) | B-41 | Air bag module (driver's side) |
| B-29 | Auto-cruise-ECU | B-42X | Power window relay |
| B-30 | Air bag module (passenger's side) | B-46 | Foot lamp (LH) |
| B-31 | Radio | B-47 | ETACS-ECU |
| B-32 | Door lock power relay | B-48 | ETACS-ECU |
| B-34 | Cigarette lighter illumination lamp | B-49 | Body wiring harness and J/B combination |
| B-35 | Cigarette lighter | B-50 | Body wiring harness and J/B combination |
| B-36 | Cigarette lighter | B-51 | Body wiring harness and J/B combination |
| B-38 | Diagnosis connector | B-52 | Body wiring harness and door wiring harness (LH) combination |
| B-39 | Key reminder switch | | |
| B-40 | Clock spring | | |

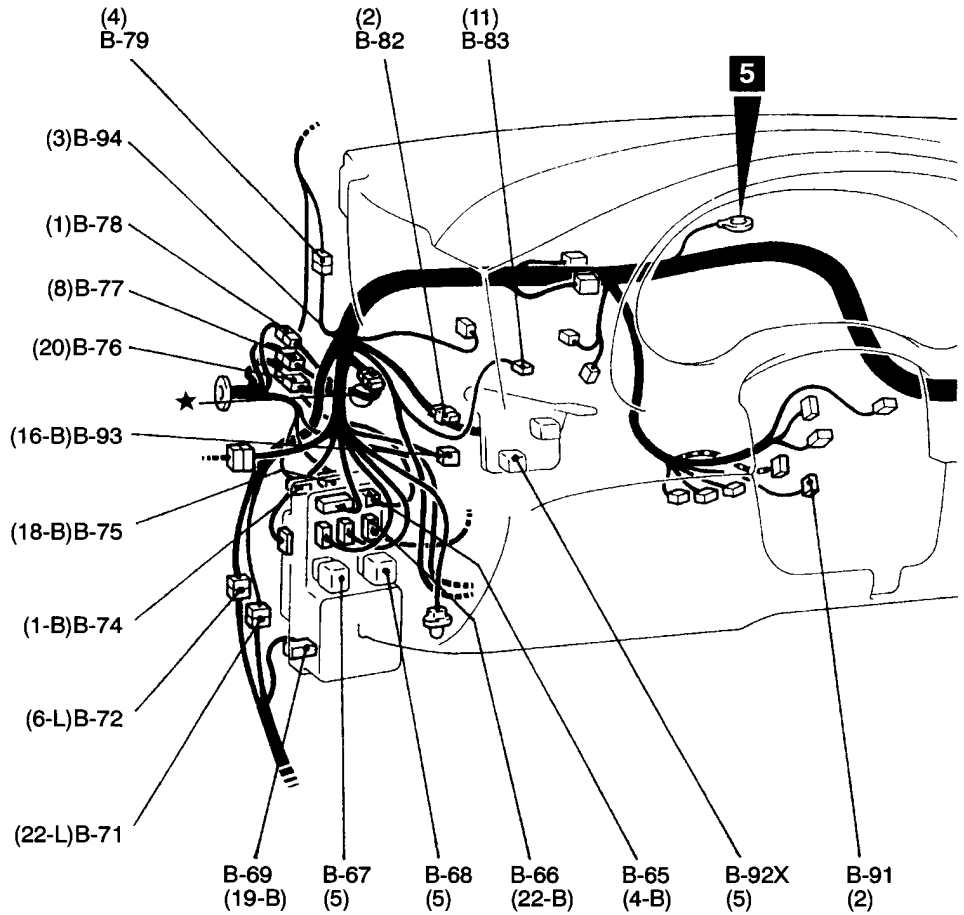
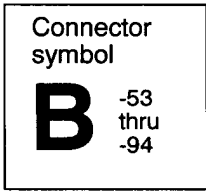

- B-53 Engine-ECU
- B-54 Engine-ECU
- B-56 Engine-ECU
- B-58 ABS-ECU
- B-59 Body wiring harness and front wiring harness combination
- B-63 Body wiring harness and control wiring harness combination
- B-64 Body wiring harness and control wiring harness combination
- B-65 Roof wiring harness and J/B combination

- B-66 Instrument panel wiring harness and J/B combination
- B-67 Defogger relay
- B-68 Blower relay
- B-69 Rear wiring harness and J/B combination
- B-71 Body wiring harness and rear wiring harness combination
- B-72 Body wiring harness and rear wiring harness combination
- B-74 Front wiring harness and J/B combination

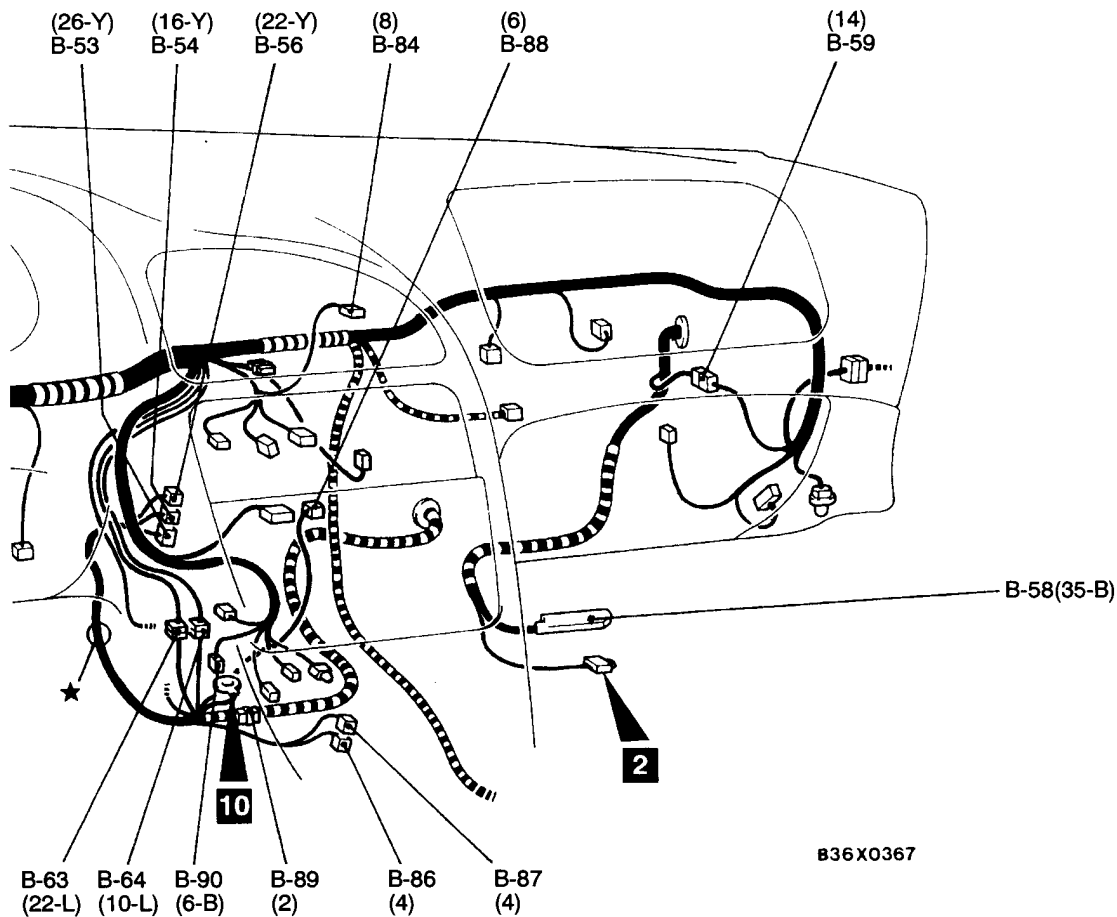

836X0367

- | | | | |
|------|--|-------|---------------------------------------|
| B-75 | Front wiring harness and J/B combination | B-84 | Rear wiper and washer switch |
| B-76 | Body wiring harness and front wiring harness combination | B-86 | Fuel pump relay |
| B-77 | Body wiring harness and front wiring harness combination | B-87 | MPI relay |
| B-78 | Body wiring harness and front wiring harness combination | B-88 | Engine oil level relay |
| B-79 | Body wiring harness and roof wiring harness combination | B-89 | Fuel octane ratio selection connector |
| B-82 | Dedicated fuse (with auto-cruise control system) | B-90 | Headlamp washer relay |
| B-83 | Remote controlled mirror switch | B-91 | Ignition key ring antenna |
| | | B-92X | Rear fog lamp relay |
| | | B-93 | Immobilizer-ECU |
| | | B-94 | Diode (for headlamp circuit) |

INSTRUMENT PANEL AND FLOOR CONSOLE

80100080091

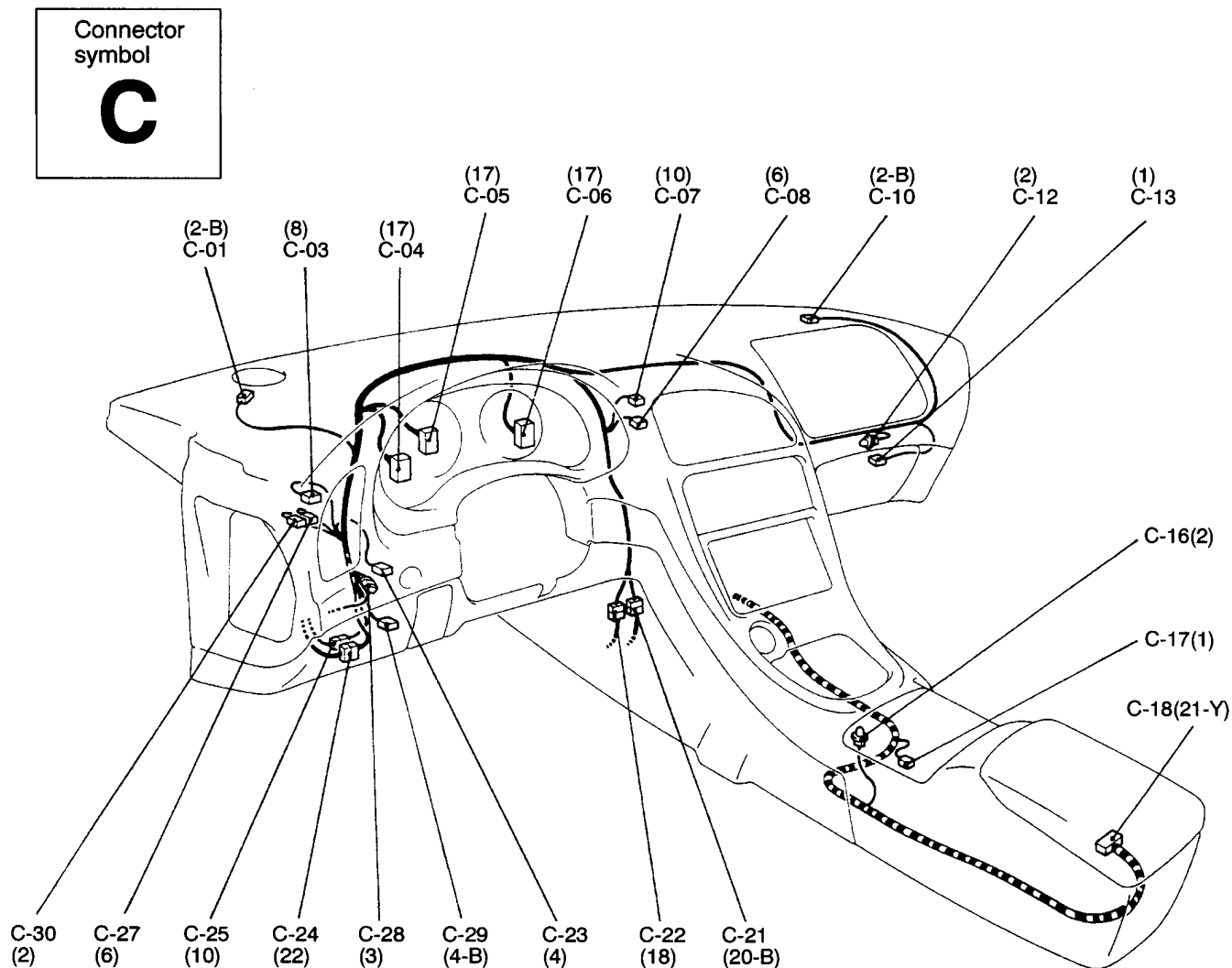

A36X0372

C-01	Front speaker (LH)	C-21	Instrument panel wiring harness and body wiring harness combination
C-03	Auto-cruise control main switch	C-22	Instrument panel wiring harness and control wiring harness combination
C-04	Combination meter	C-23	Rheostat
C-05	Combination meter	C-24	Instrument panel wiring harness and body wiring harness combination
C-06	Combination meter	C-25	Instrument panel wiring harness and front wiring harness combination
C-07	Hazard warning lamp switch	C-27	Front fog lamp switch
C-08	Defogger switch	C-28	Diode (for door-ajar warning lamp circuit)
C-10	Front speaker (RH)	C-29	Headlamp leveling switch
C-12	Glove box lamp	C-30	Rear fog lamp switch
C-13	Glove box lamp switch		
C-16	Ashtray illumination lamp		
C-17	Parking brake switch		
C-18	SRS-ECU		

DOOR

80100140133

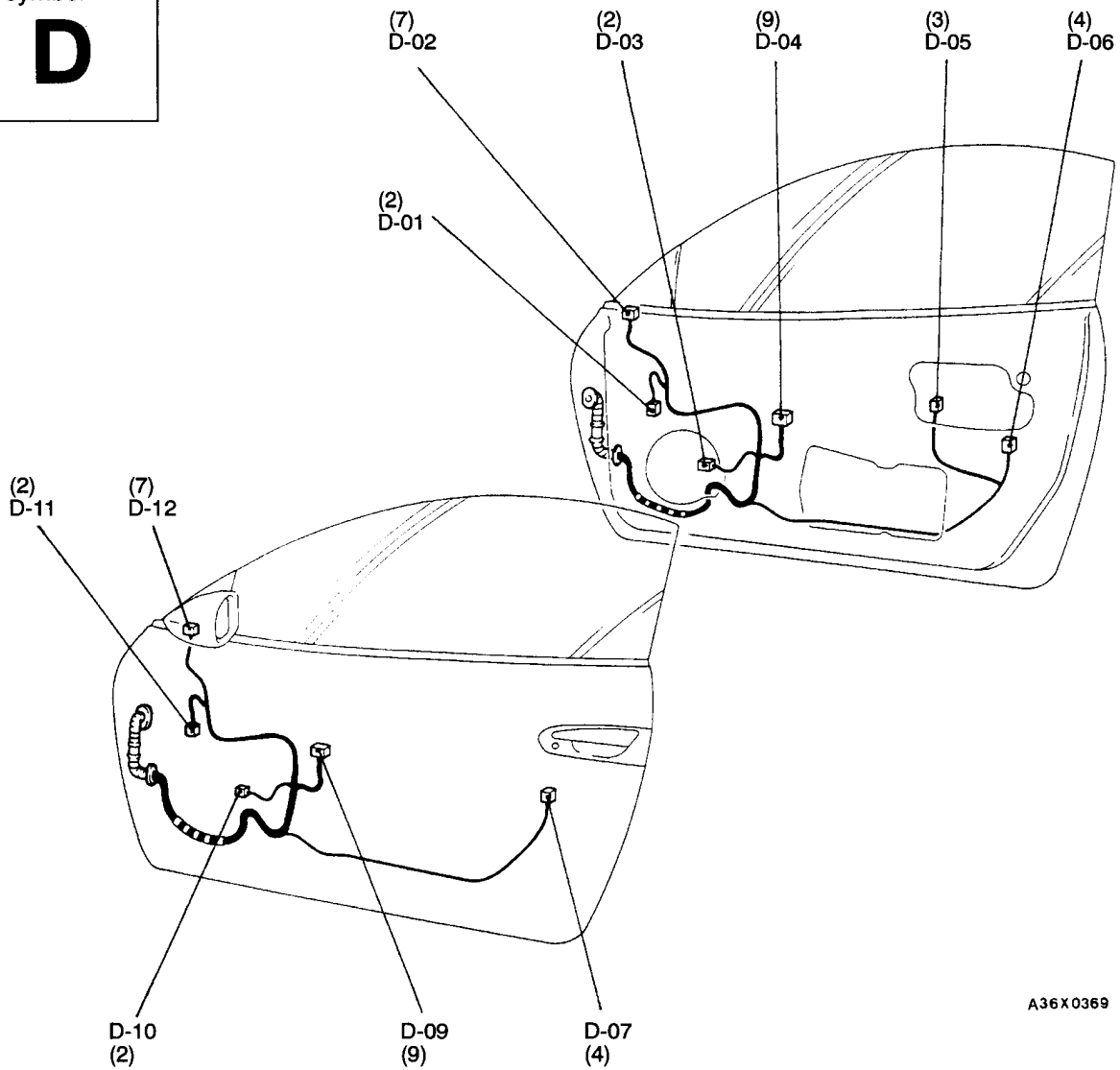
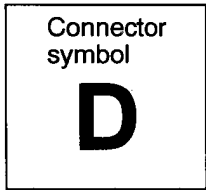

A36X0369

- | | | | |
|------|------------------------------------|------|--------------------------|
| D-01 | Power window motor (RH) | D-07 | Door lock actuator (LH) |
| D-02 | Door mirror (RH) | D-09 | Power window main switch |
| D-03 | Door speaker (RH) | D-10 | Door speaker (LH) |
| D-04 | Power window sub switch | D-11 | Power window motor (LH) |
| D-05 | Door lock key cylinder switch (RH) | D-12 | Door mirror (LH) |
| D-06 | Door lock actuator (RH) | | |

INTERIOR

80100090179

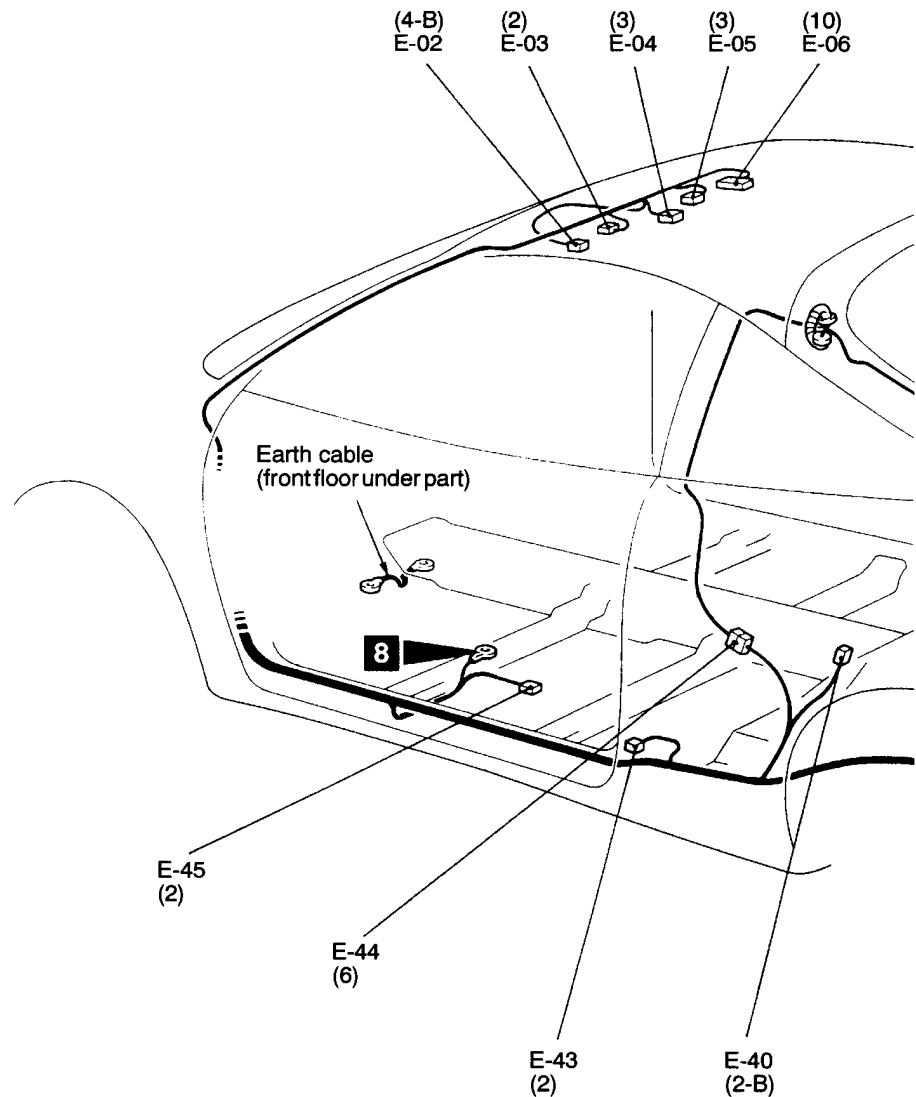
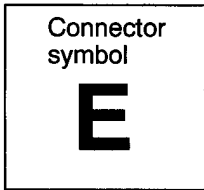

E-02 Room lamp <with sunroof>
 E-03 Sunroof motor
 E-04 Room lamp <without sunroof>
 E-05 Sunroof switch
 E-06 Sunroof-ECU
 E-09 Rear wiring harness and fuel wiring harness combination
 E-10 Defogger (+)
 E-11 Door switch (RH)

E-13 Rear speaker (RH)
 E-14 Defogger (-)
 E-15 Rear wiper motor
 E-16 High-mounted stop lamp
 E-17 Rear combination lamp (RH)
 E-18 Rear combination lamp (RH)
 E-19 Luggage compartment lamp switch
 E-22 Back-up lamp (RH)
 E-23 Licence plate lamp (RH)

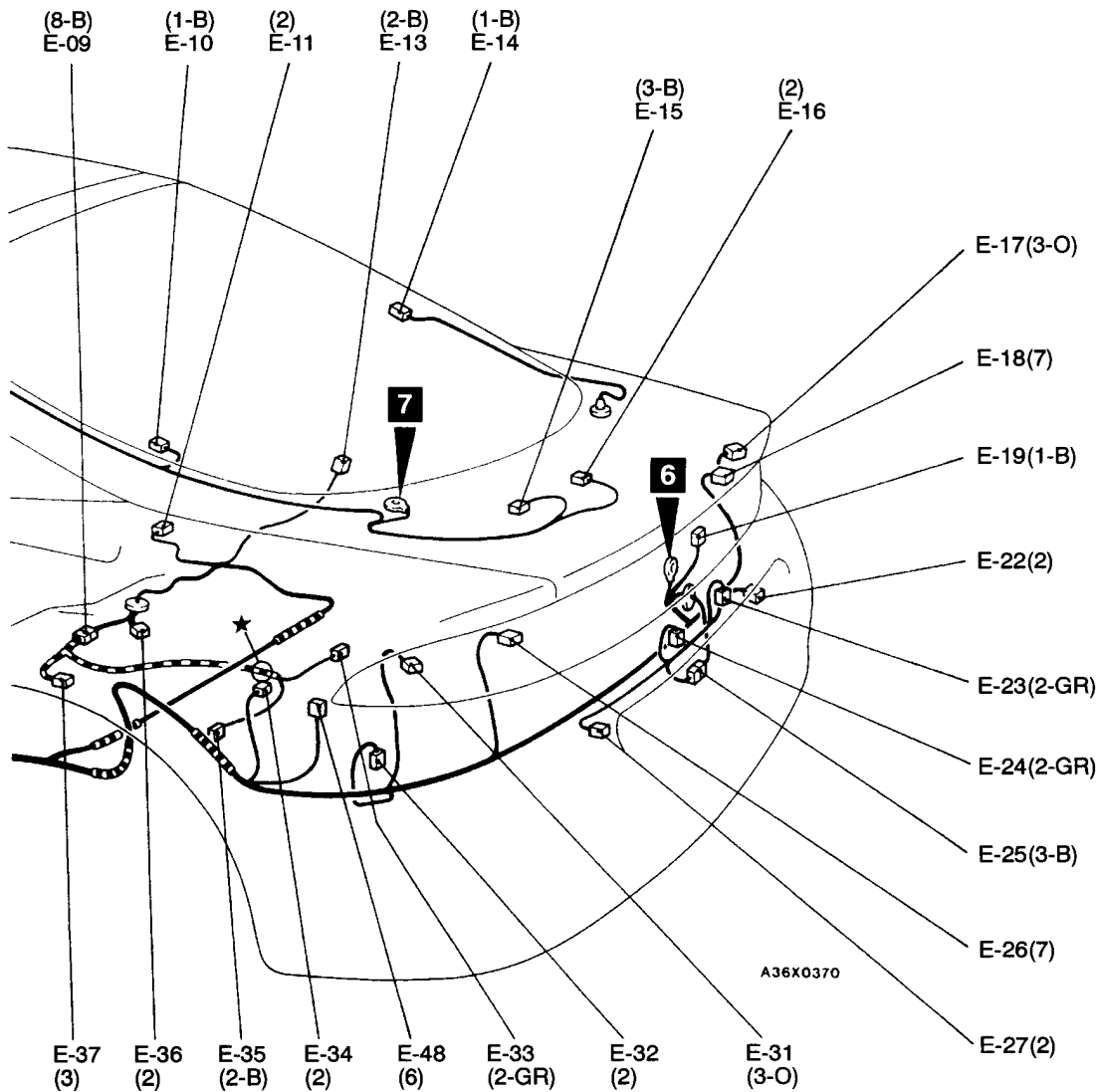

- | | | | |
|------|---|------|---|
| E-24 | Licence plate lamp (LH) | E-35 | ABS wheel-speed sensor (rear:LH) |
| E-25 | Rear wiring harness and licence plate lamp wiring harness combination | E-36 | Fuel pump |
| E-26 | Rear combination lamp (LH) | E-37 | Fuel gauge unit |
| E-27 | Back-up lamp (LH) | E-40 | Rear speaker (LH) |
| E-31 | Rear combination lamp (LH) | E-43 | Door switch (LH) |
| E-32 | Rear washer motor | E-44 | Rear wiring harness and tailgate wiring harness combination |
| E-33 | ABS wheel-speed sensor (rear:RH) | E-45 | Power seat assembly |
| E-34 | Luggage compartment lamp | E-48 | Motor antenna assembly |

NOTES

3 SINGLE PART INSTALLATION POSITION

70109000075

RELAY	3-2	INSPECTION CONNECTOR	3-11
ECU	3-5	FUSIBLE LINK AND FUSE	3-12
SENSOR	3-7	EARTH CABLE	3-13
SOLENOID VALVE	3-9	EARTH	3-14
DIODE	3-10		

RELAY

70100040113

Name	Symbol	Name	Symbol
A/C compressor clutch relay	A	Horn relay	A
Alternator relay	B	Motor antenna control relay	L
Blower relay	E	Motor relay <ABS> (built in hydraulic unit)	D
Condensor fan relay (HI) (LO)	A	MPI relay	I
Defogger relay	E	Power window relay	F
Door lock power relay	H	Radiator fan relay (HI) (LO)	A
DRL relay 1, 2	C	Rear fog lamp relay	F
Engine oil level relay	J	Rear intermittent wiper relay (built in rear wiper and washer switch)	K
Front fog lamp relay	A	Tail lamp relay	A
Fuel pump relay	I	Turn-signal and hazard flasher unit	J
Headlamp relay	A	Valve relay <ABS> (built in hydraulic unit)	D
Headlamp washer relay	H	Windshield intermittent wiper relay (built in column switch)	G

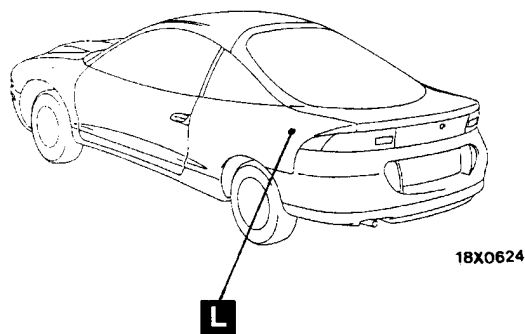
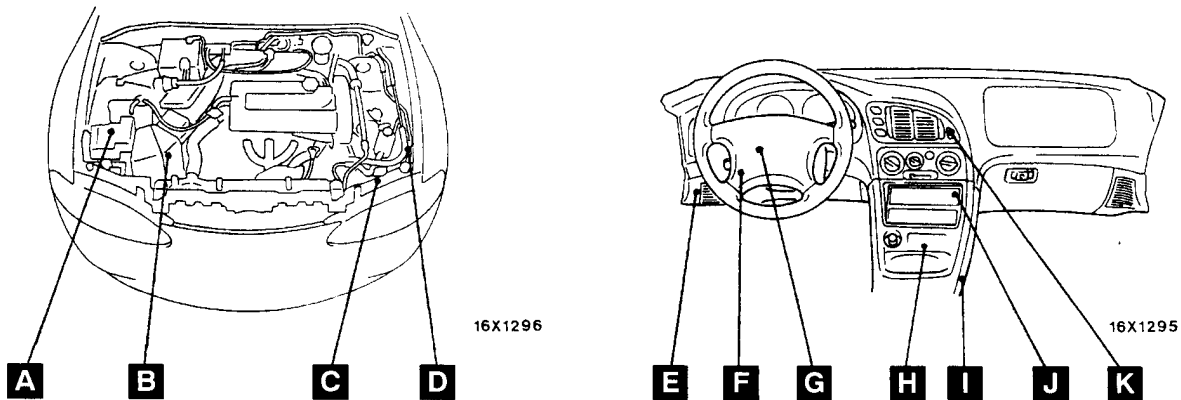

00004368

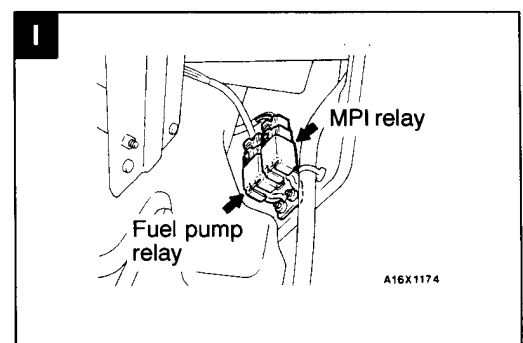
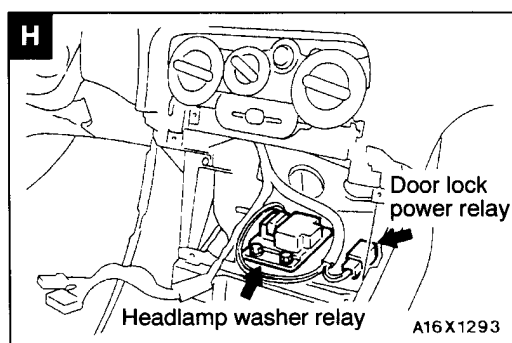
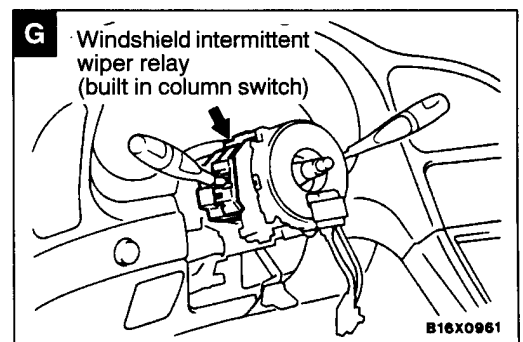
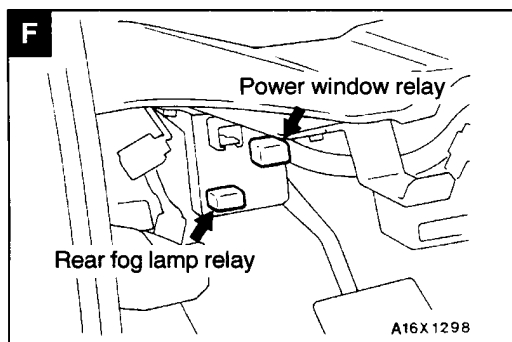
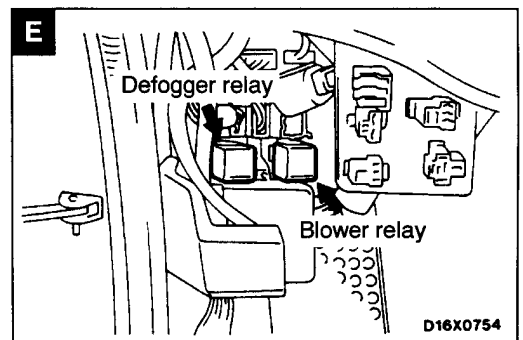
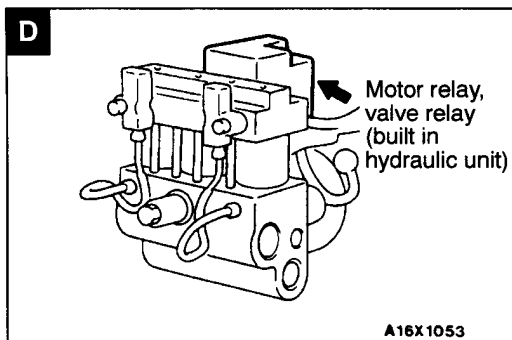
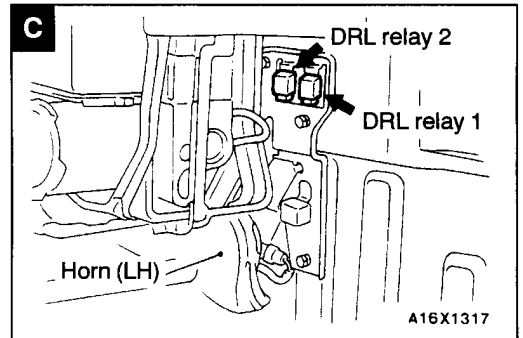
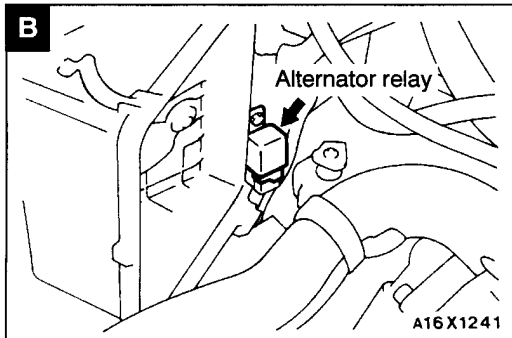
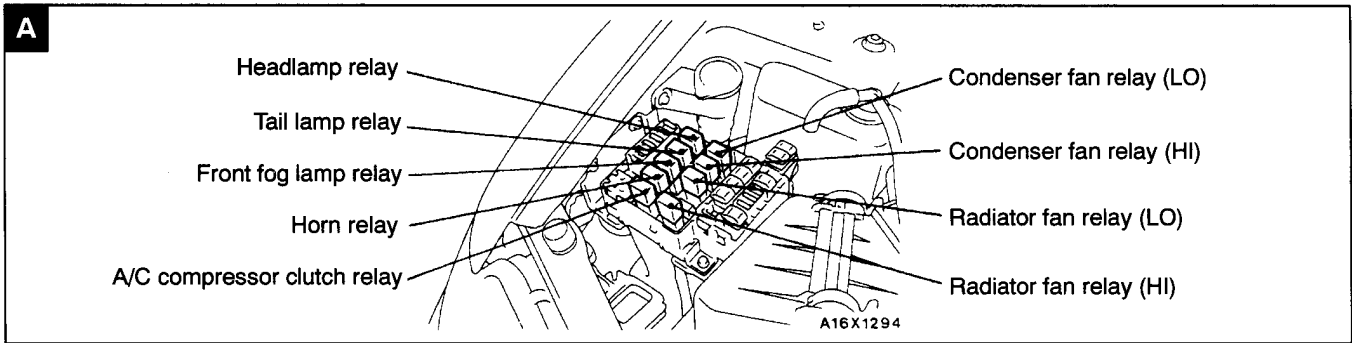

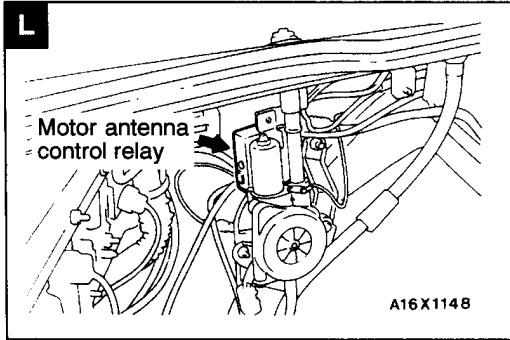
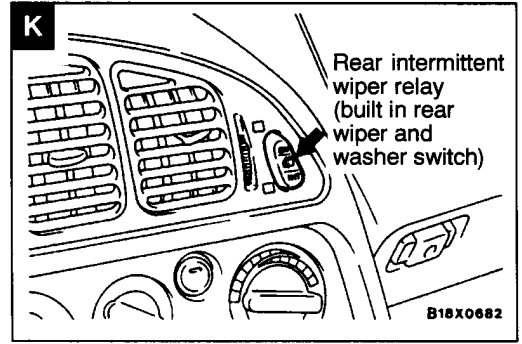
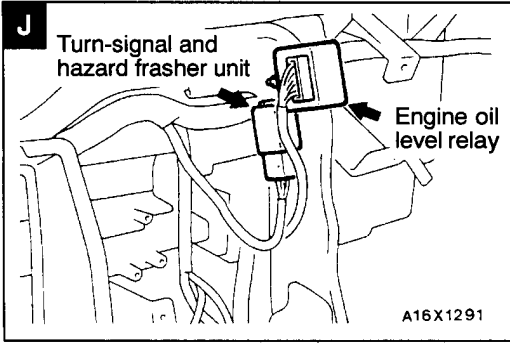

ECU

70100050031

Name	Symbol	Name	Symbol
ABS-ECU	G	ETACS-ECU	C
A/C-ECU	F	Immobilizer-ECU	B
Auto-cruise-ECU	H	SRS-ECU	D
DRL-ECU	A	Sunroof-ECU	I
Engine-ECU	E		

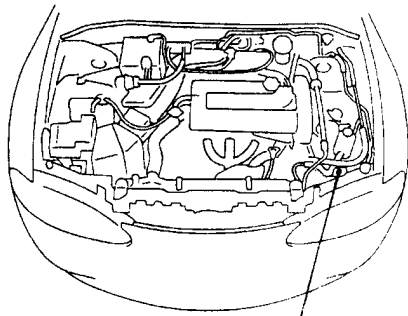

A 16X1296

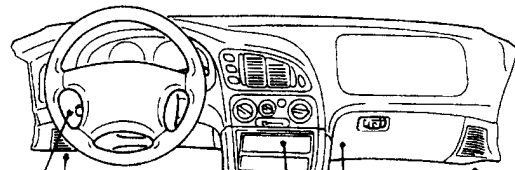

B C D E F G H 16X1295

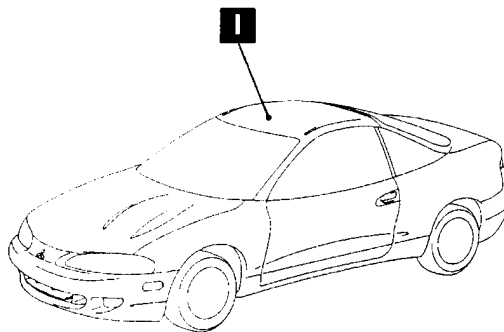

18X0623

00004369

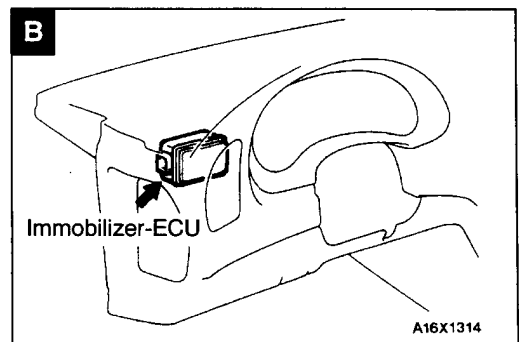
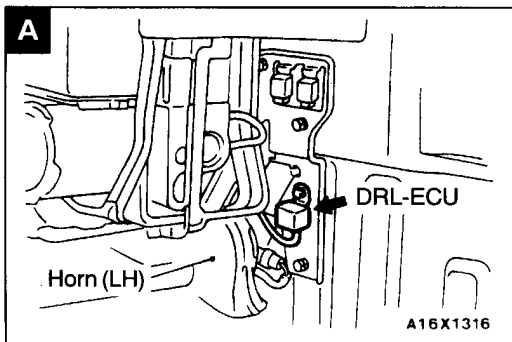

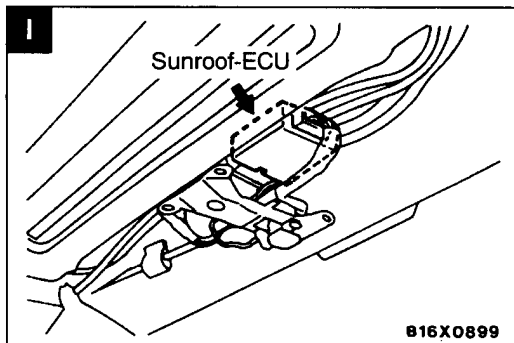
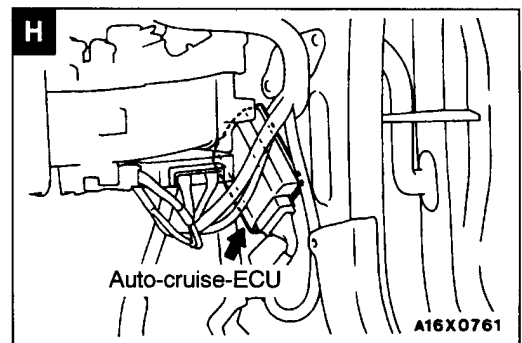
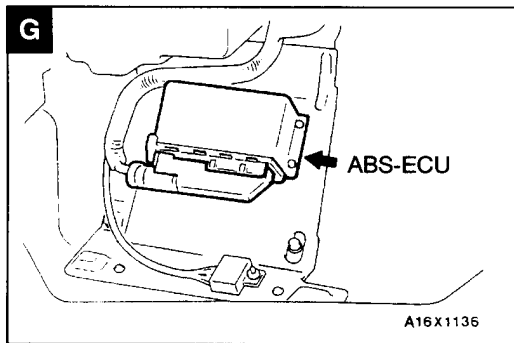
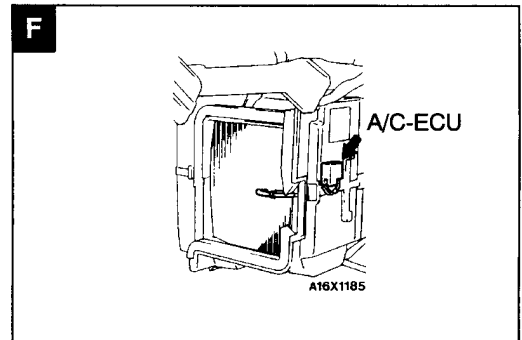
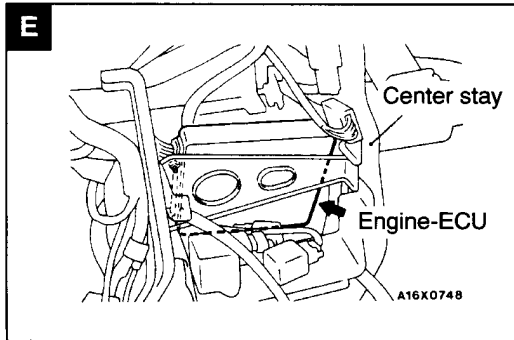
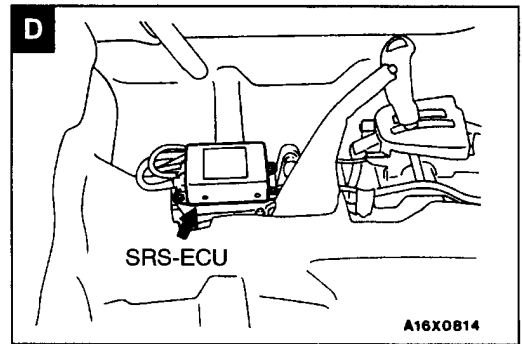
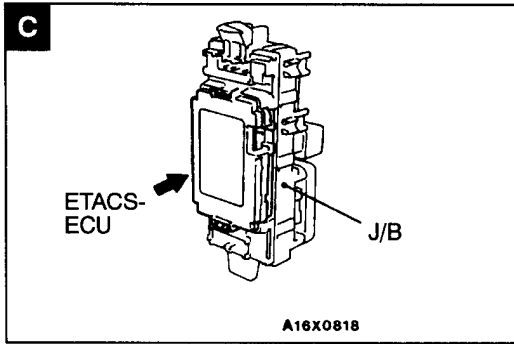

SENSOR

70100060126

Name	Symbol	Name	Symbol
ABS wheel-speed sensor (front)	I	Engine coolant temperature sensor	F
ABS wheel-speed sensor (rear)	L	Engine oil level sensor	K
Air flow sensor	E	Fin thermo sensor	H
Camshaft position sensor	D	Oxygen sensor	J
Crankshaft position sensor	G	Throttle position sensor	B
Detonation sensor	C	Vehicle speed sensor	A

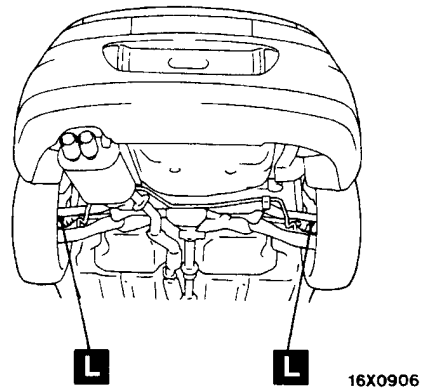
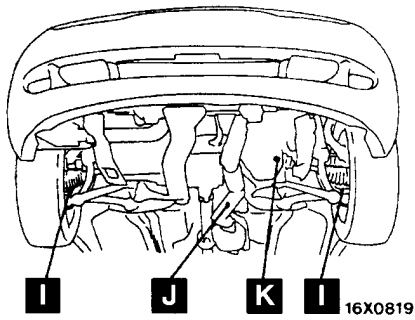
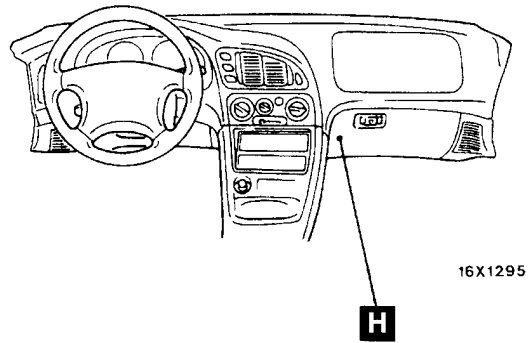
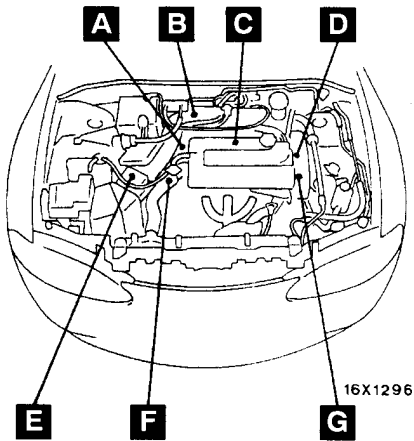

00004370

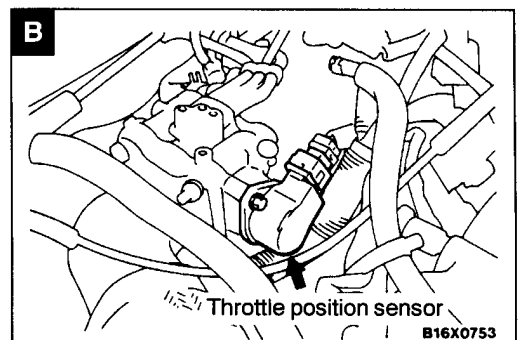
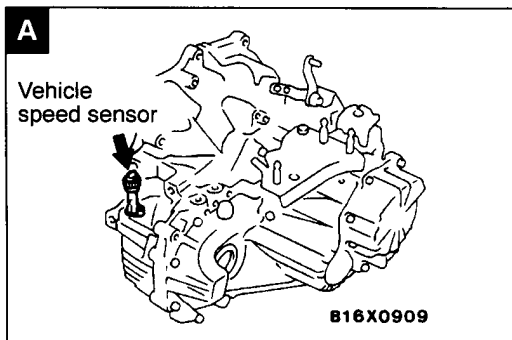

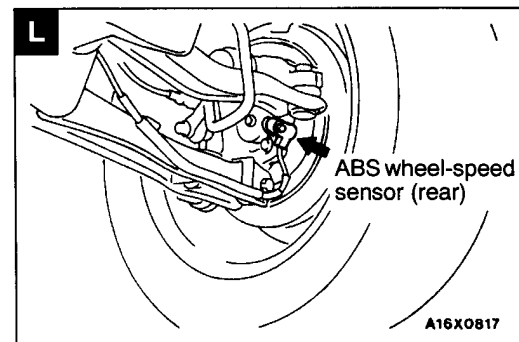
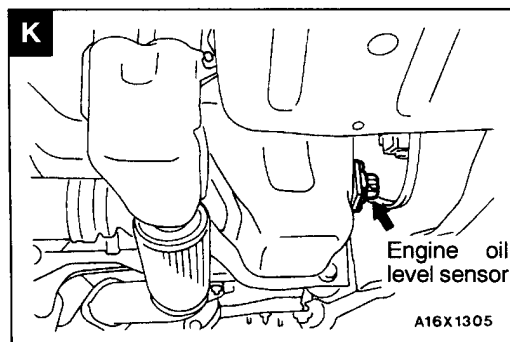
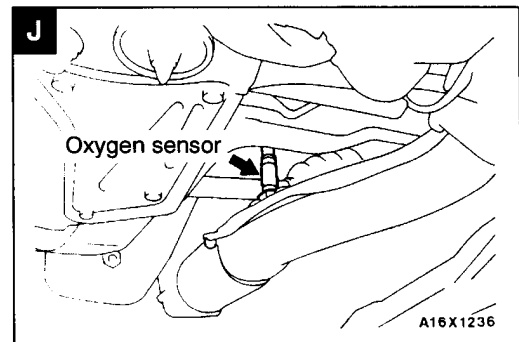
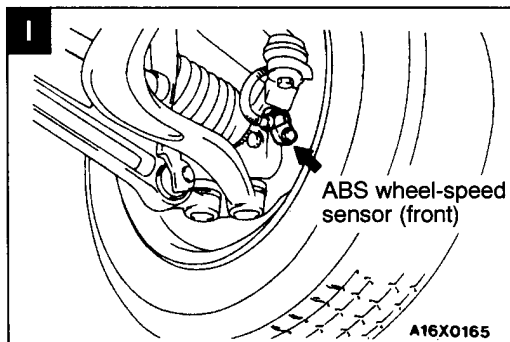
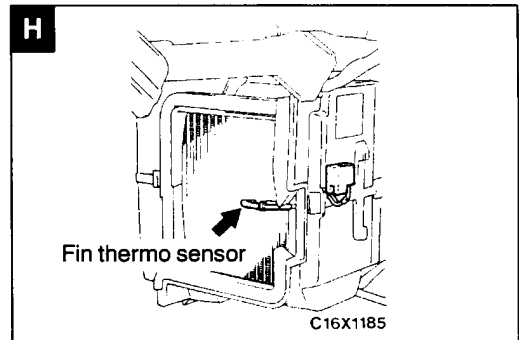
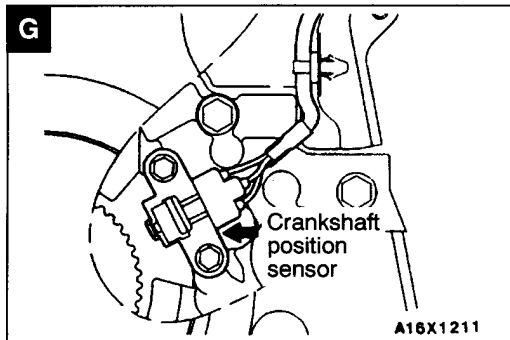
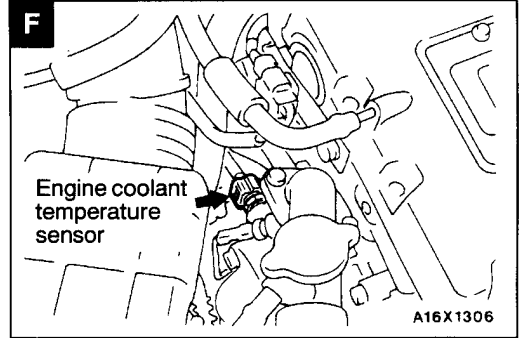
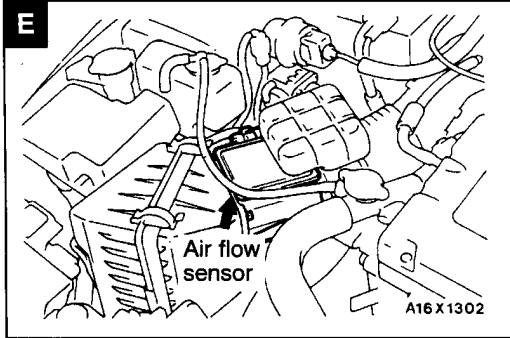
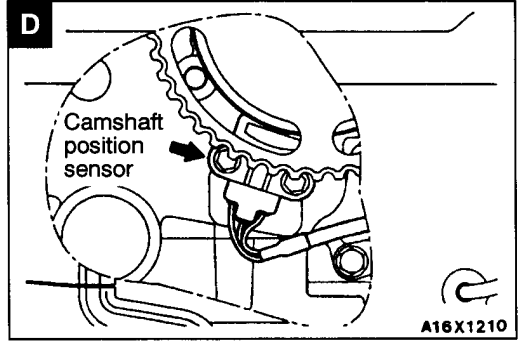
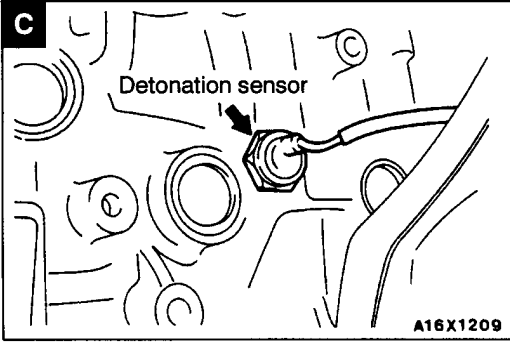

SOLENOID VALVE

70100080092

Name	Symbol	Name	Symbol
Control valve (built in auto-cruise control vacuum pump)	A	Release valve (built in auto-cruise control vacuum pump)	A
EGR solenoid valve	B	Solenoid valve <ABS> (built in hydraulic unit)	C
Purge solenoid valve	B		

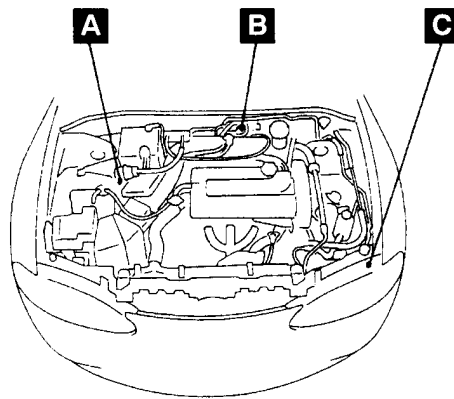

A16X1296

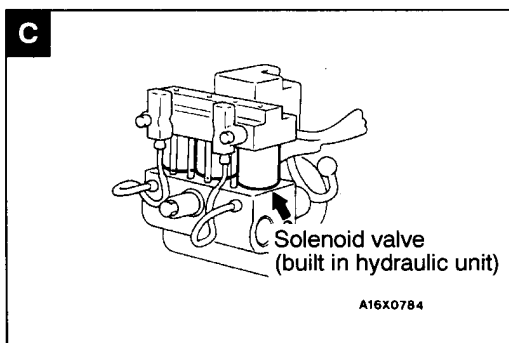
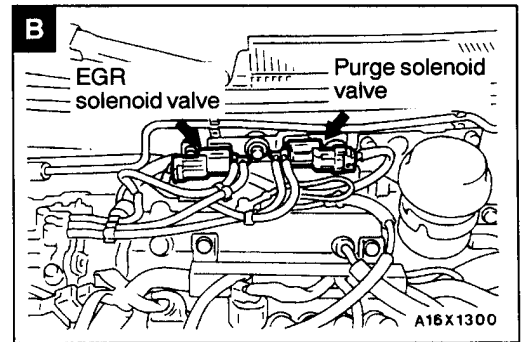
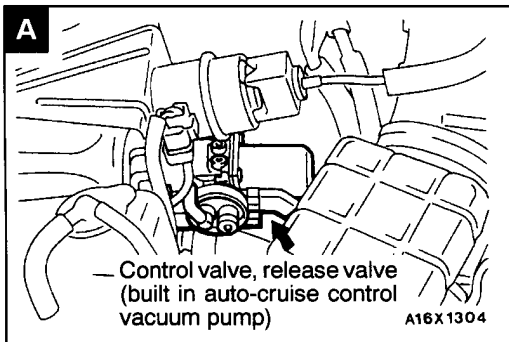

DIODE

70100090118

Name	Symbol	Name	Symbol
Diode (for door-ajar warning lamp circuit)	A	Diode (for idle up circuit)	C
		Diode (for headlamp circuit)	B

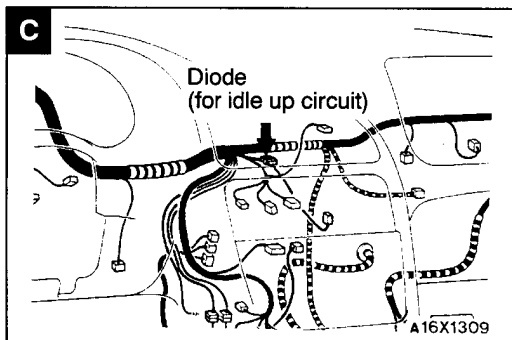
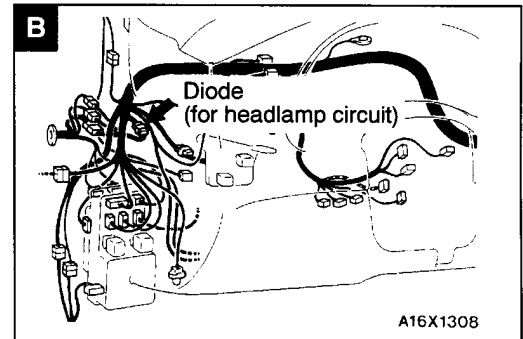
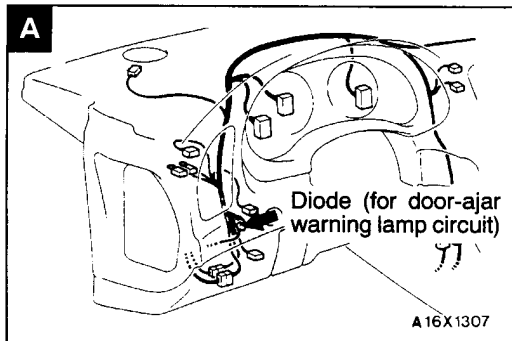
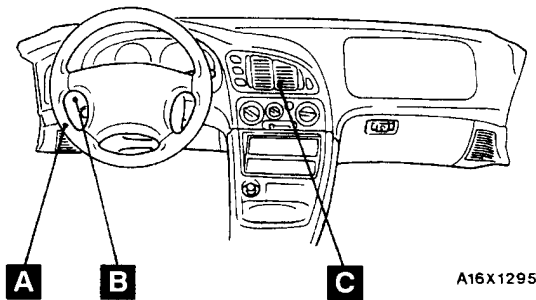

INSPECTION CONNECTOR

70100020100

Name	Symbol	Name	Symbol
Diagnosis connector	B	Fuel pump check connector	A
Engine speed detection connector	A	Ignition timing adjustment connector	A

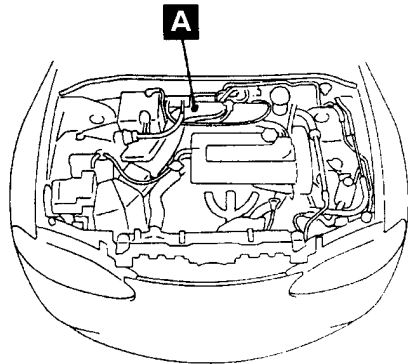

16X1296

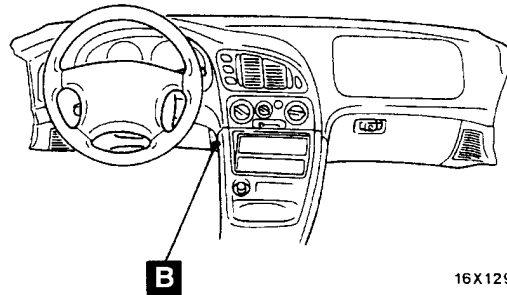

16X1295

00004371

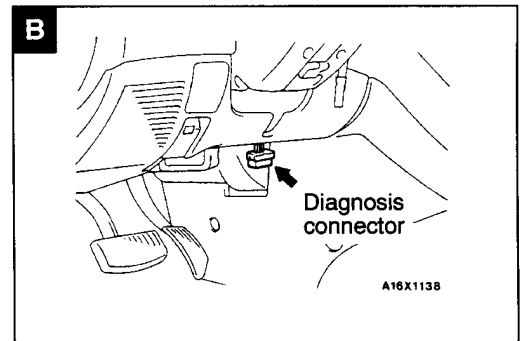
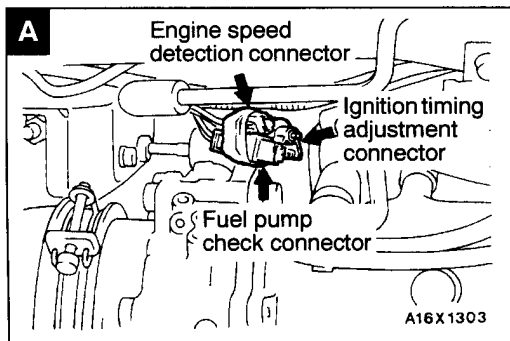

3-12 SINGLE PART INSTALLATION POSITION – Fusible Link and Fuse

FUSIBLE LINK AND FUSE

70100010107

Name	Symbol	Name	Symbol
Dedicated fuse (for auto-cruise control system)	C	Dedicated fuse No.13	E
		Multi-purpose fuses	D
Dedicated fuses No.2-12	A	Fusible links	B

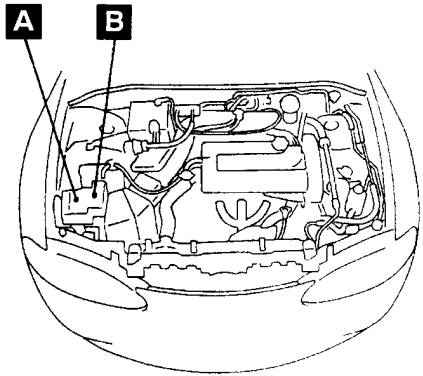

16X1296

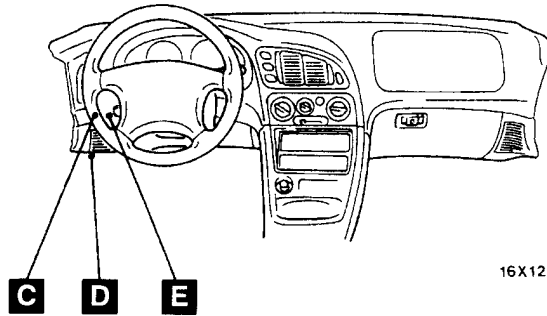

16X1295

00004372

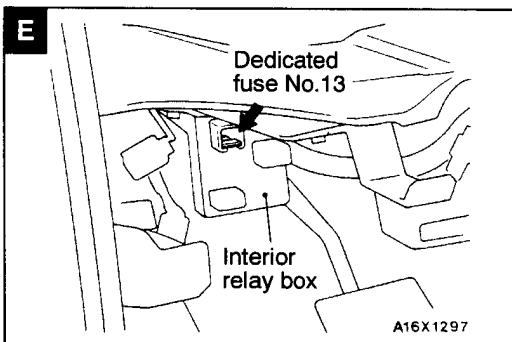
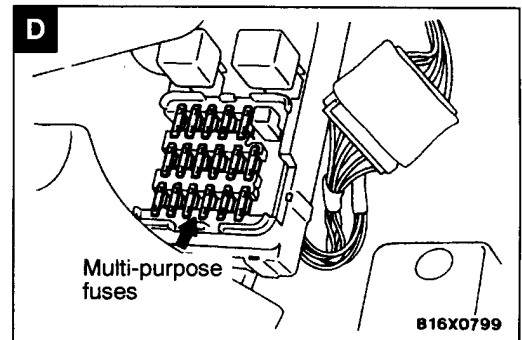
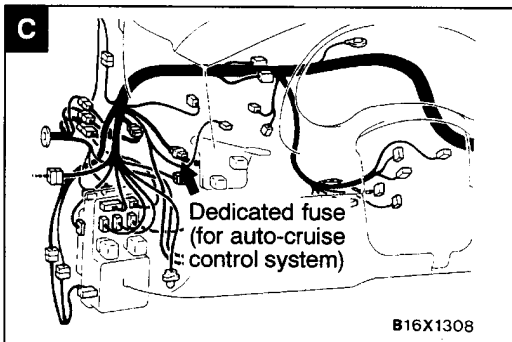
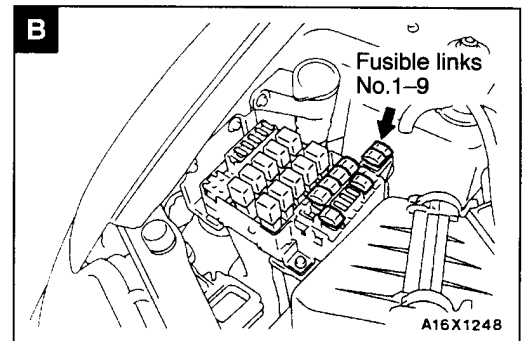
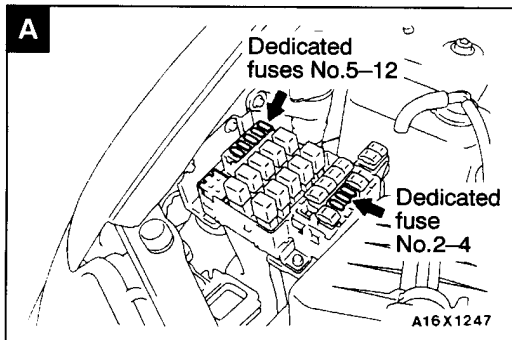

EARTH CABLE

70100100057

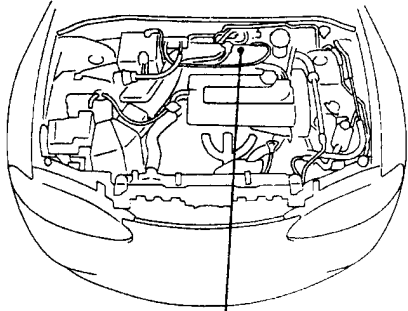

16X1296

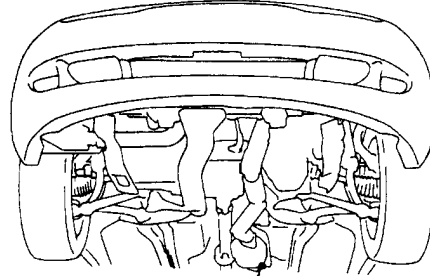

16X0819

00004373

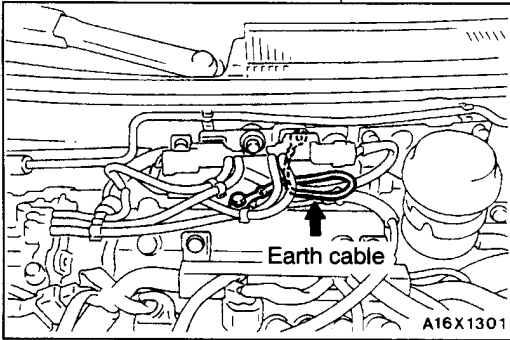

Earth cable

A16X1301

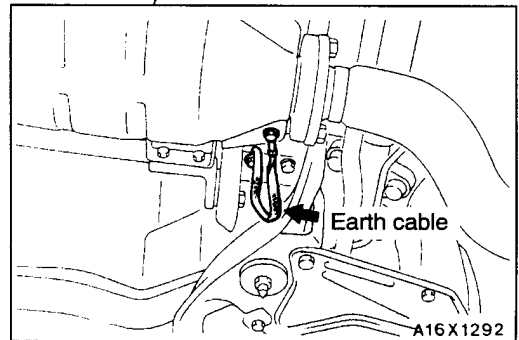

Earth cable

A16X1292

EARTH

70100030134

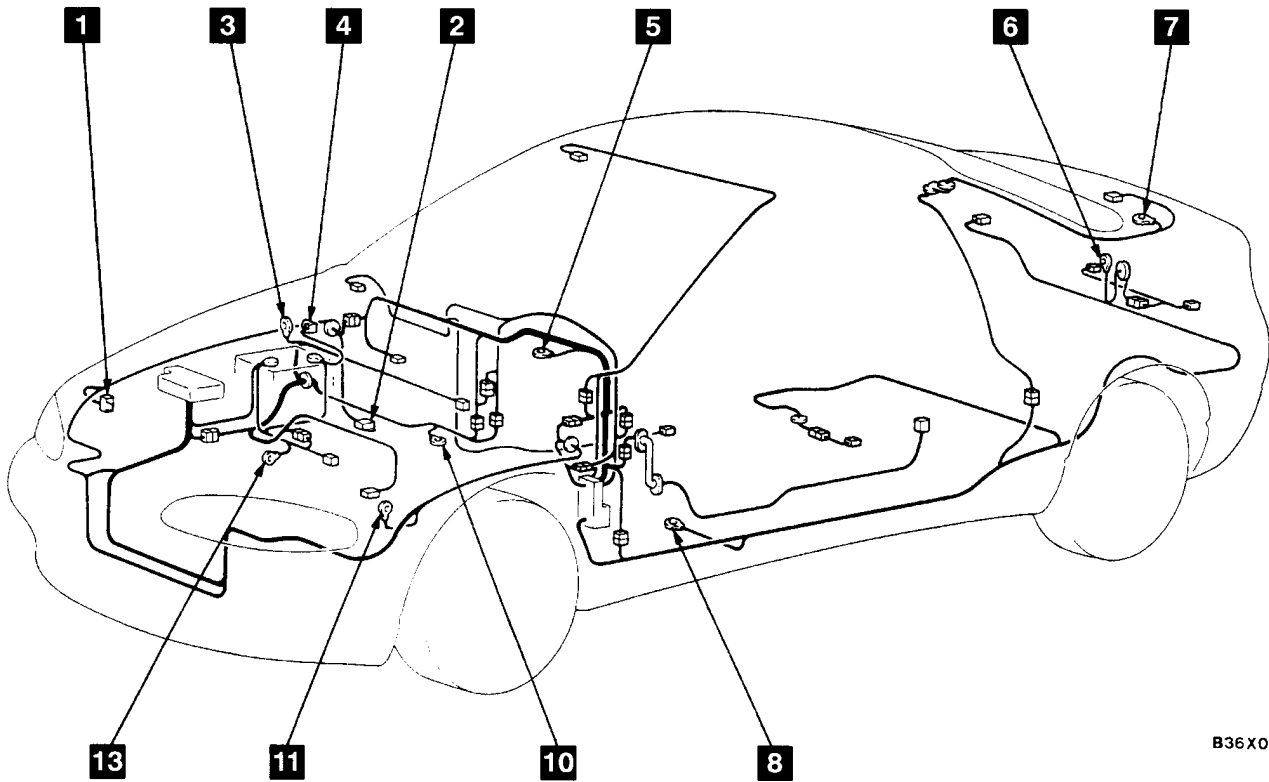

B36X0368

NOTE
Same earth numbers are used in the circuit diagram.

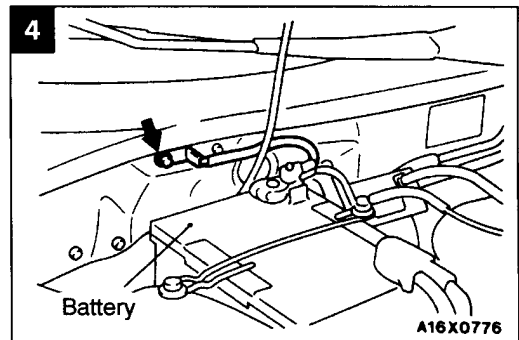
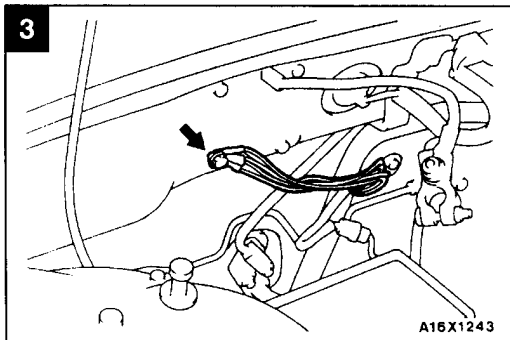
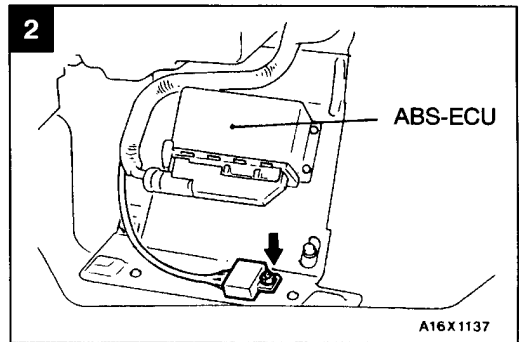
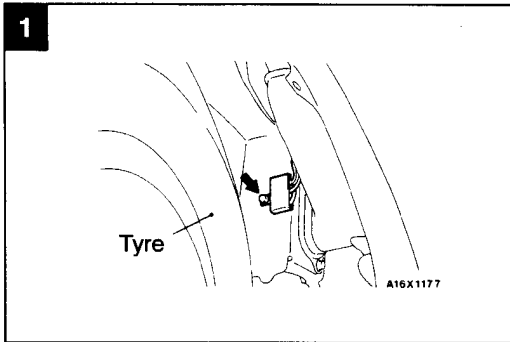

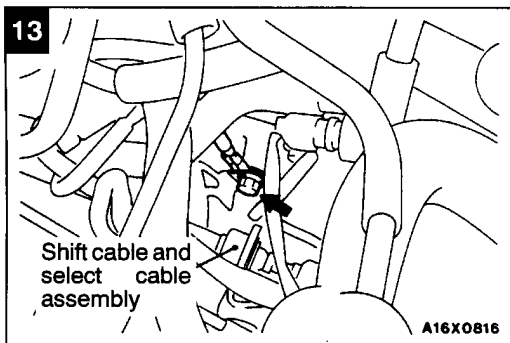
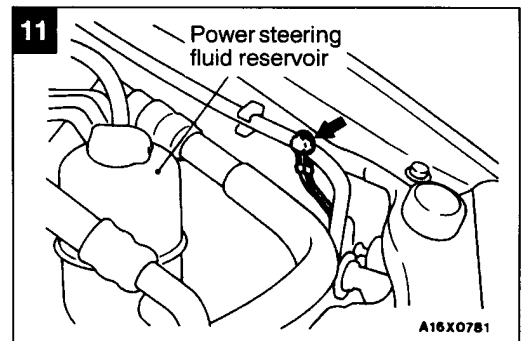
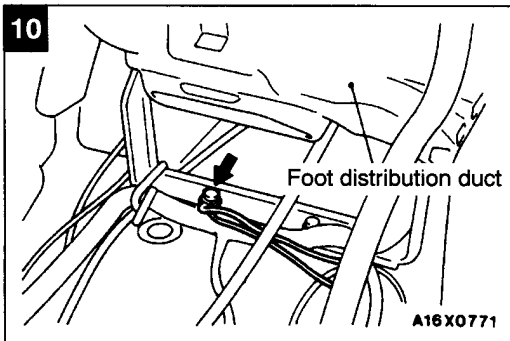
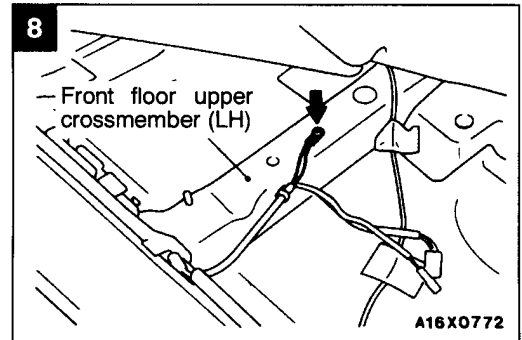
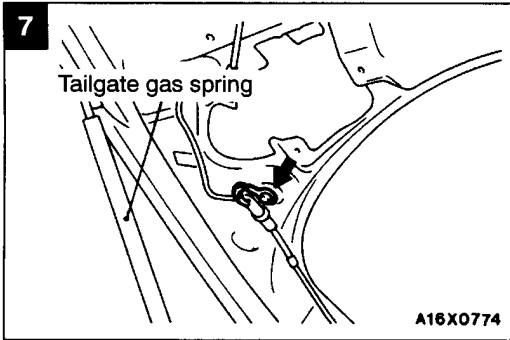
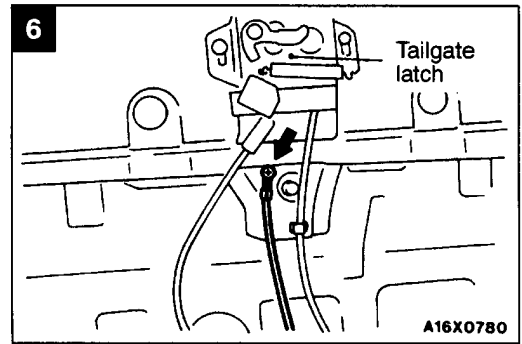
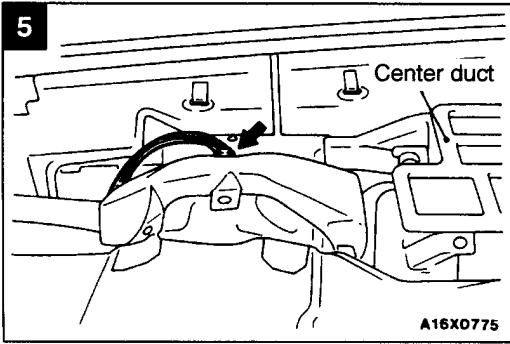

NOTES

4 CIRCUIT DIAGRAMS

9010900097

JUNCTION BLOCK (J/B)	4-2	METER AND GAUGES	4-62
JOINT CONNECTOR (J/C)	4-4	BRAKE WARNING LAMP	4-66
CENTRALIZED JUNCTION	4-5	OIL PRESSURE WARNING LAMP	4-66
POWER DISTRIBUTION SYSTEM	4-10	FUEL WARNING LAMP	4-67
STARTING SYSTEM	4-16	ENGINE OIL LEVEL WARNING LAMP ...	4-67
IGNITION SYSTEM	4-17	CENTRAL DOOR LOCKING SYSTEM	4-70
CHARGING SYSTEM	4-18	POWER WINDOWS	4-73
MPI SYSTEM	4-20	HEATER	4-74
COOLING SYSTEM	4-28	AIR CONDITIONER	4-76
HEADLAMP		WINDSHIELD WIPER AND WASHER	4-80
Vehicles without daytime running lamp	4-30	REAR WIPER AND WASHER	4-84
Vehicles with daytime running lamp	4-34	REAR WINDOW DEFOGGER	4-86
HEADLAMP LEVELING SYSTEM	4-38	HEADLAMP WASHER	4-88
TAIL LAMP, POSITION LAMP AND LICENCE PLATE LAMP	4-40	REMOTE CONTROLLED MIRROR	4-89
FRONT FOG LAMP	4-44	RADIO WITH TAPE PLAYER	4-90
REAR FOG LAMP	4-46	CIGARETTE LIGHTER	4-92
GLOVE BOX LAMP	4-49	ANTI-SKID BRAKING SYSTEM	4-94
ROOM LAMP, FOOT LAMP AND LUGGAGE COMPARTMENT LAMP	4-50	AUTO-CRUISE CONTROL SYSTEM	4-98
IGNITION KEY CYLINDER ILLUMINATION LAMP	4-53	SUPPLEMENTAL RESTRAINT SYSTEM (SRS)	4-102
TURN-SIGNAL LAMP AND HAZARD LAMP	4-54	IMMOBILIZER SYSTEM	4-104
STOP LAMP	4-58	POWER SEAT	4-106
BACK-UP LAMP	4-60	LIGHTING MONITOR BUZZER	4-108
HORN	4-61	SUNROOF	4-110

JUNCTION BLOCK (J/B)

90100020139

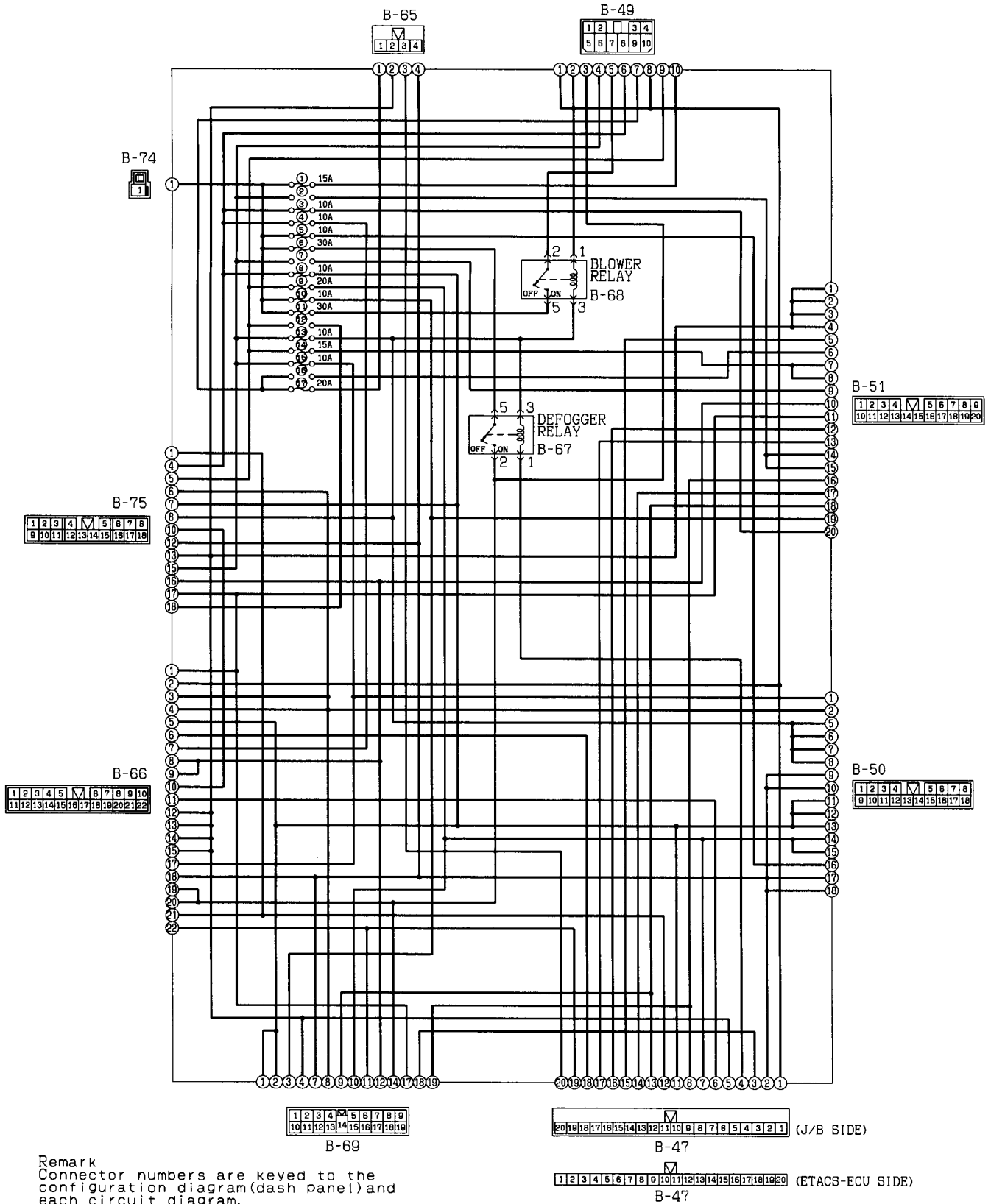

Remark
 Connector numbers are keyed to the configuration diagram (dash panel) and each circuit diagram.

Front side

Rear side

To front wiring harness

To front wiring harness

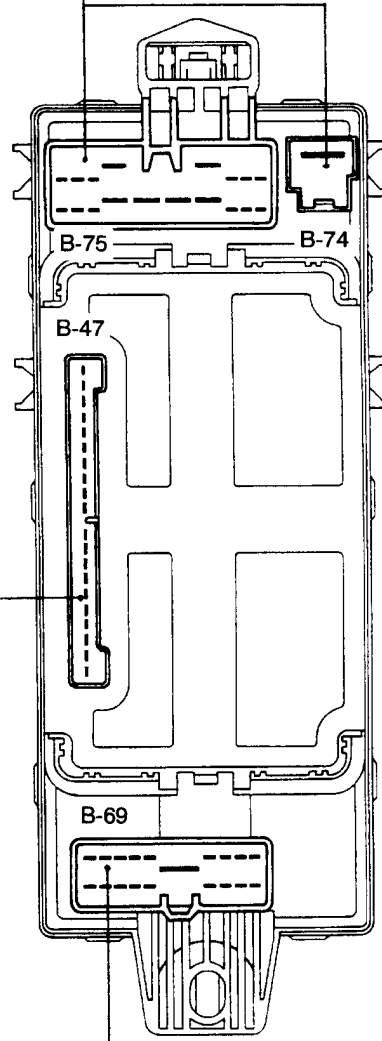
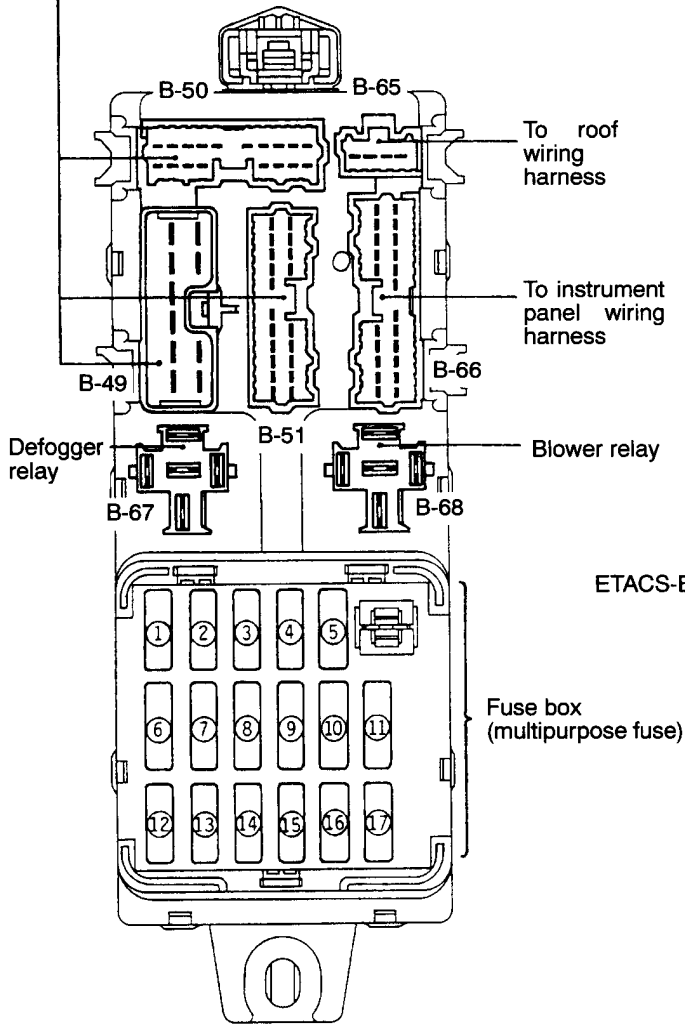

16Z0009

To rear wiring harness

16Z0010

00004374

JOINT CONNECTOR (J/C)

90100020146

J/C (1) B-07

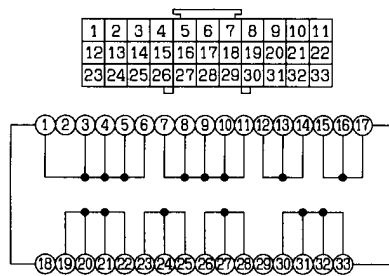

J/C (2) B-08

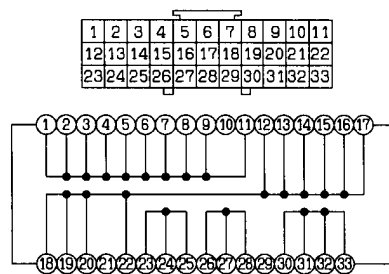

Remark

·On actual vehicles, any of the terminals connected in J/C are used.
 The terminals described in the circuit diagram may not be identical to those of the vehicles.

CENTRALIZED JUNCTION

90100030149

FUSIBLE LINK (Relay box in engine compartment)

No.	Circuit	Housing colour	Rated capacity (A)
1	Charging system and circuits using fusible links Nos. 2 and 9.	Blue	100
2	Circuits using dedicated fuses Nos. 8 and 11, circuit using multi-purpose fuses Nos. 6, 10, and 11	Yellow	60
3	—	—	—
4	MPI system and immobilizer system	Light blue	20
5	Charging system, circuits using dedicated fuse No.16, circuits using headlamp relay, and circuit using tail lamp relay	Green	40
6	Circuits using multi-purpose fuse No.17 and ignition switch	Pink	30
7	Air conditioner and cooling system	Pink	30
8	Anti-skid braking system	Red	50
9	Power seat and power windows	Pink	30
10	—	—	—

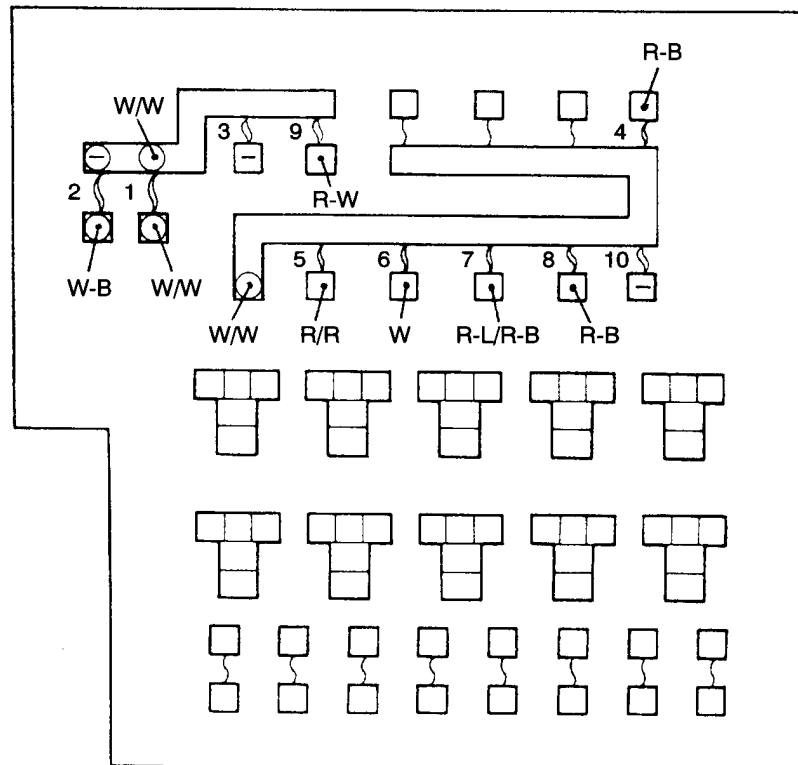

A16X1270

DEDICATED FUSE

Power supply circuit	No.	Rated capacity (A)	Housing colour	Circuit
—	1	—	—	—
Battery	2	15	Blue	Anti-lock braking system, auto-cruise control system and stop lamp
	3	15	Blue	Horn
	4	15	Blue	Turn-signal lamp and hazard lamp
Tail lamp relay	5	10	Red	Tail lamp, position lamp and licence plate lamp
Fusible link No. 5	6	15	Blue	Front fog lamp
Headlamp relay	7	10	Red	Headlamp and headlamp leveling system
Fusible link No. 2	8	10	Red	Air conditioner
Battery	9	20	Yellow	Air conditioner and cooling system
Tail lamp relay	10	10	Red	Air conditioner, auto-cruise control system, cigarette lighter, front fog lamp, glove box lamp, heater, headlamp leveling system, headlamp washer, lighting monitor buzzer, meter and gauge, radio with tape player, rear fog lamp, rear window defogger, rear wiper and washer, remote controlled mirror, tail lamp, position lamp, licence plate lamp, turn-signal lamp and hazard lamp
Fusible link No. 2	11	10	Red	Anti-lock braking system, auto-cruise control system, central door locking system, door lamp, foot lamp, luggage compartment lamp, ignition key cylinder illumination lamp, immobilizer system, lighting monitor buzzer, meter and gauge, MPI system, radio with tape player, rear window, defogger and supplemental restraint system
Ignition switch (ACC)	12	10	Red	Auto-cruise control system and radio with tape player
	13	10	Red	Remote controlled mirror
—	14	—	—	—

(Relay box in engine compartment)

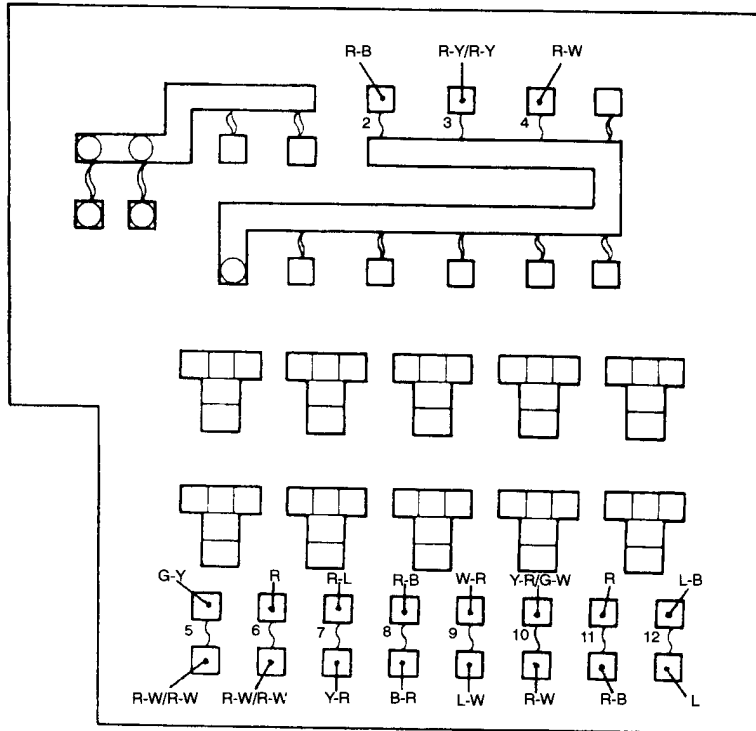

16X1270

(Relay box in passenger compartment)

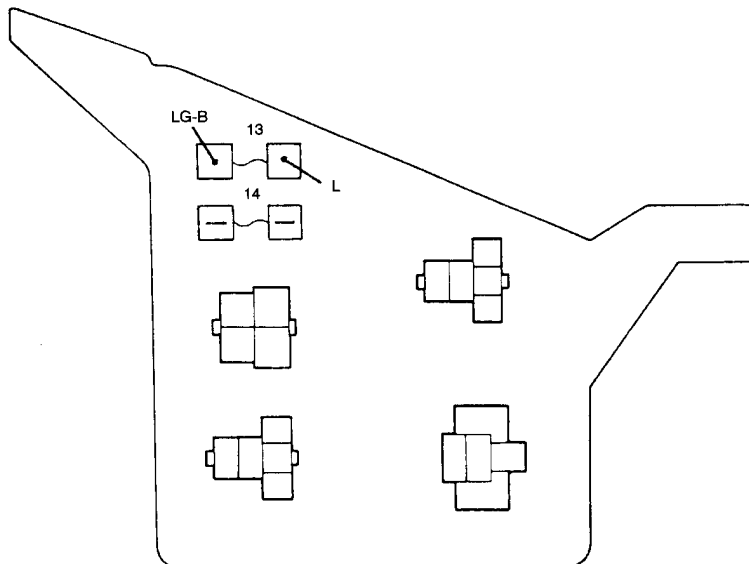

16X0903

00004375

MULTI-PURPOSE FUSE (In junction block)

Power supply circuit	No.	Rated capacity (A)	Housing colour	Load circuit	
Battery	1	—	—	—	
Ignition switch	IG2	2	—	—	
	IG1	3	10	Red	Back-up lamp and SRS-ECU
		4	10	Red	Turn-signal and hazard frasher unit
Battery	5	—	—	—	
	6	30	Pink	Defogger	
Ignition switch	IG2	7	—	—	
	IG1	8	10	Red	Combination meter, ETACS-ECU, SRS-ECU, sunroof-ECU, immobilizer-ECU, motor antenna assembly and auto-cruise control main switch
	ACC	9	20	Yellow	Windshield intermittent wiper relay, windshield wiper motor, windshield washer motor, rear intermittent wiper relay, rear wiper motor, rear washer motor and headlamp washer relay
Battery	10	10	Red	Door lock power relay and door lock actuator	
	11	30	Pink	Blower motor	
Ignition switch	ACC	12	—	—	
	IG2	13	10	Red	DRL-ECU, DRL relay (1), power window relay, blower relay, A/C-ECU, radiator fan relay, condensor fan relay (HI), defogger relay and ABS-ECU
	ACC	14	15	Blue	Cigarette lighter
	IG2	15	—	—	—
Battery	16	—	—	—	
	17	20	Yellow	Sunroof-ECU	

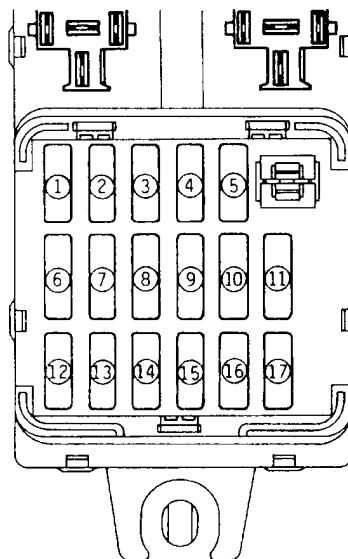

CENTRALIZED RELAY

Connector No.	Name	Connector No.	Name
A-09X	Condensor fan relay (LO)	A-16X	Front fog lamp relay
A-10X	Condensor fan relay (HI)	A-17X	Horn relay
A-11X	Radiator fan relay (LO)	A-18X	A/C compressor clutch relay
A-12X	—	B-42X	Power window relay
A-13X	Radiator fan relay (HI)	B-43X	—
A-14X	Headlamp relay	B-44X	—
A-15X	Tail lamp relay	B-92X	Rear fog lamp relay

(Relay box in engine compartment)

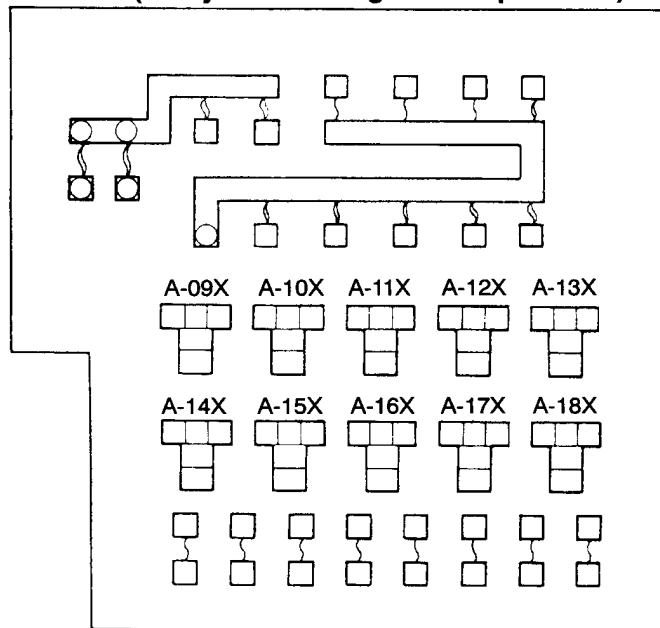

16X1270

(Relay box in passenger compartment)

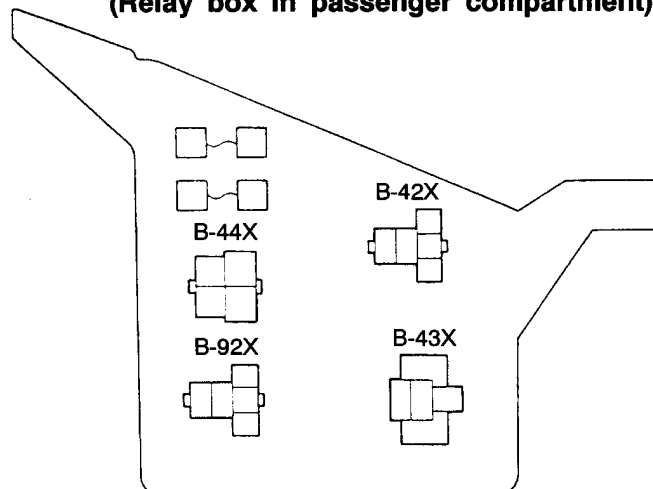

00004376

16X0903

POWER DISTRIBUTION SYSTEM

90100040166

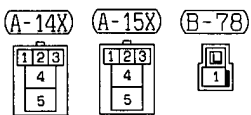
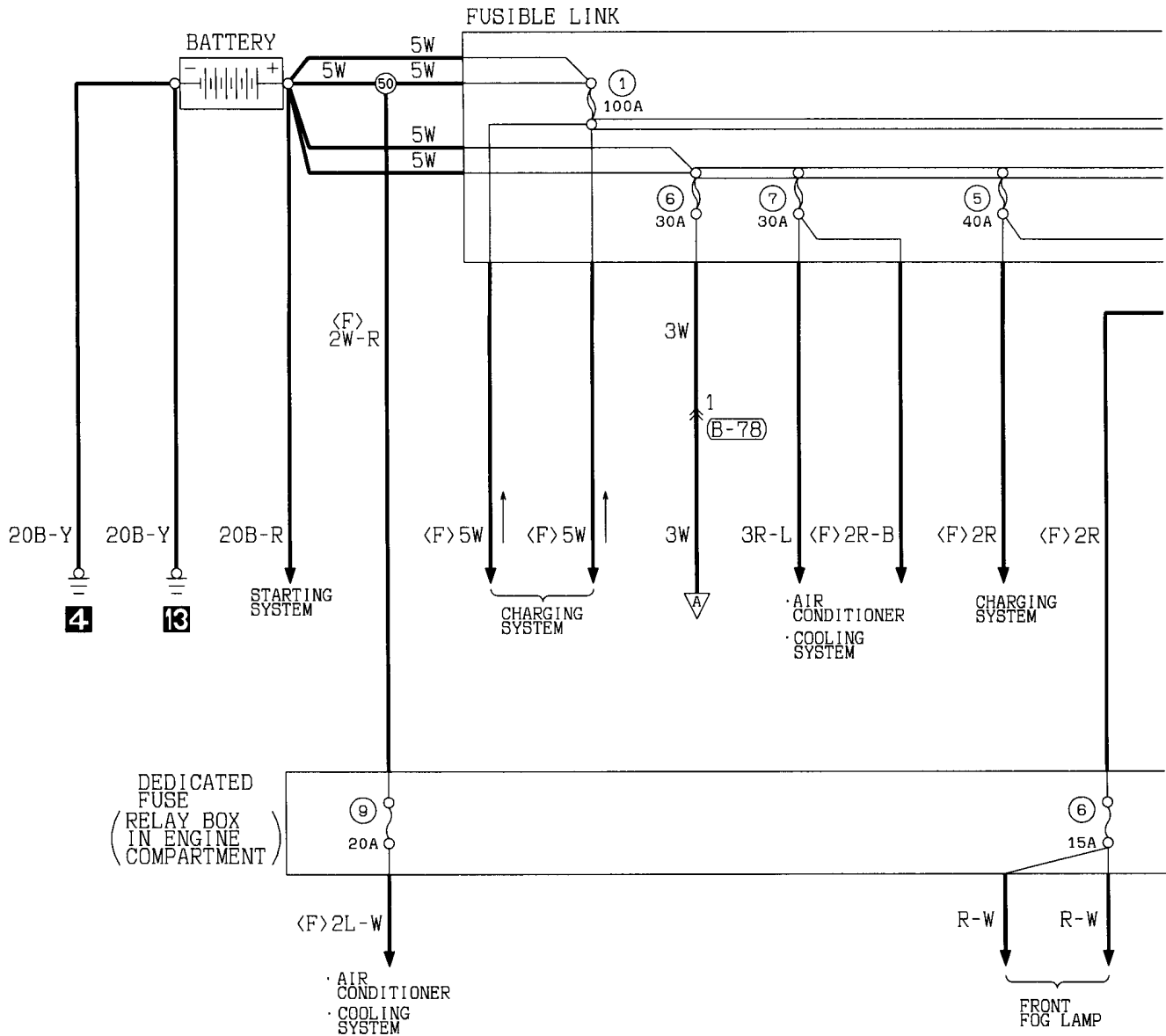

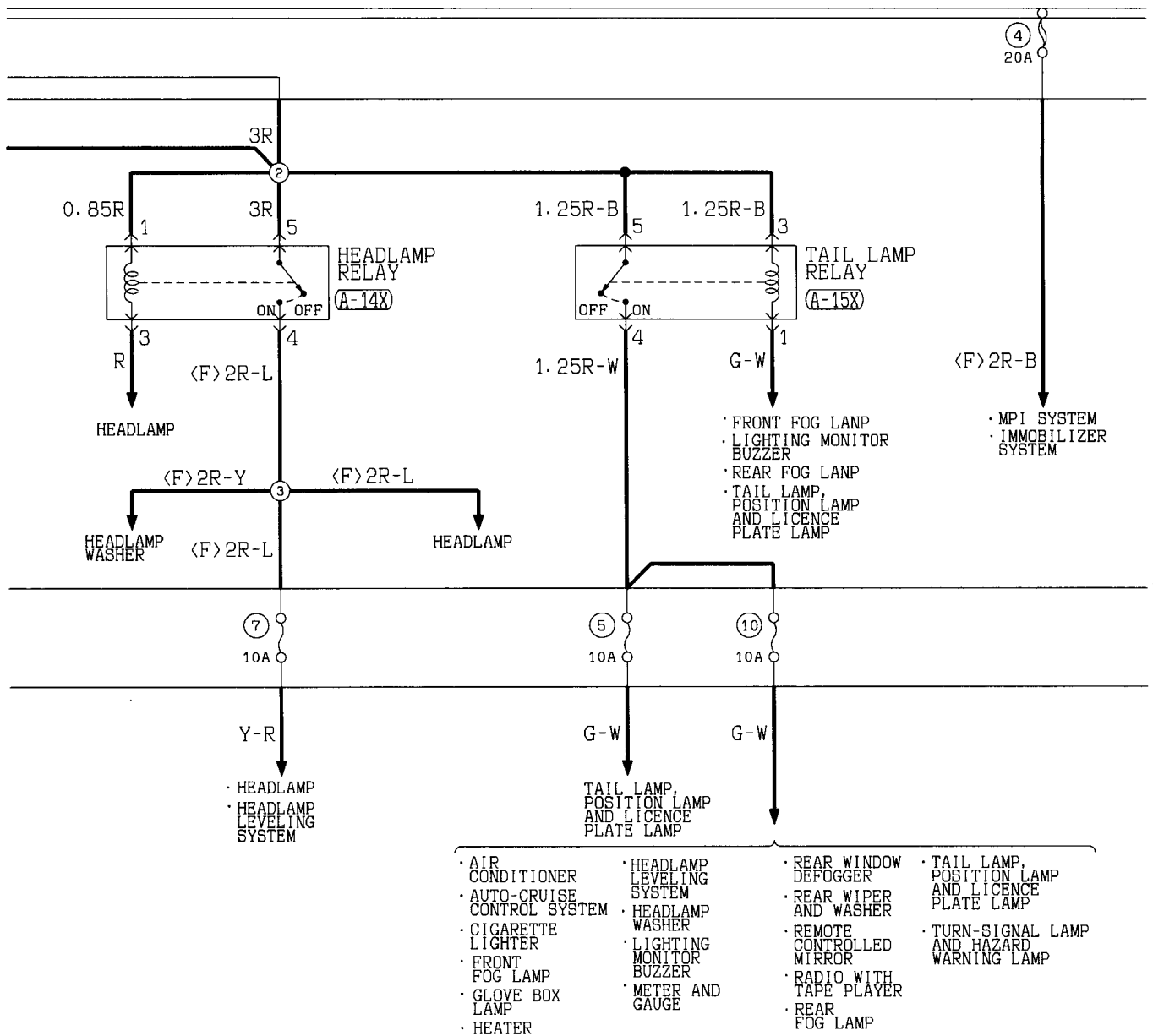

Wire colour code
 B:Black LG:Light green G:Green L:Blue W:White Y:Yellow SB:Sky blue
 BR:Brown O:Orange GR:Gray R:Red P:Pink V:Violet

POWER DISTRIBUTION SYSTEM (CONTINUED)

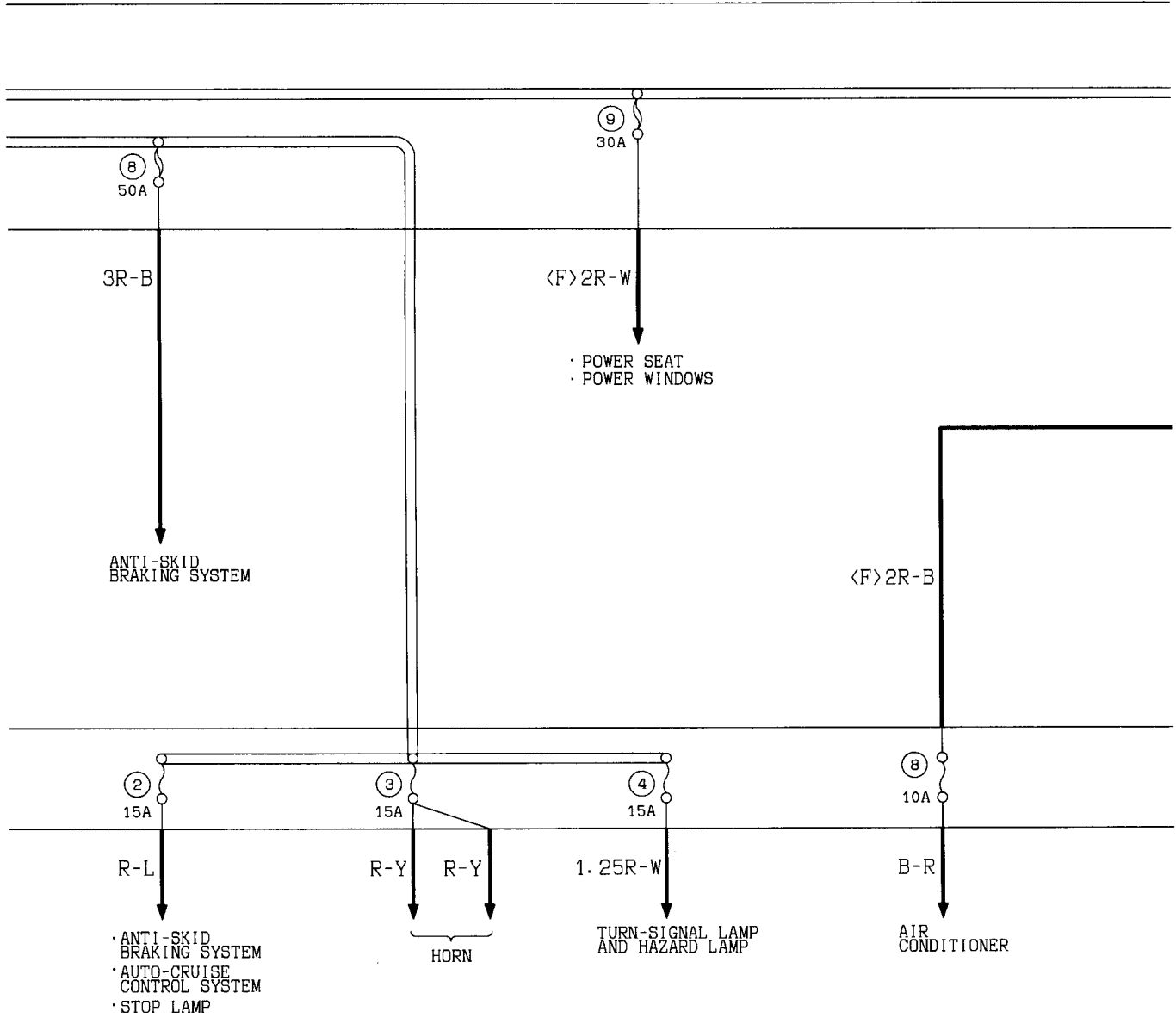

(B-74)



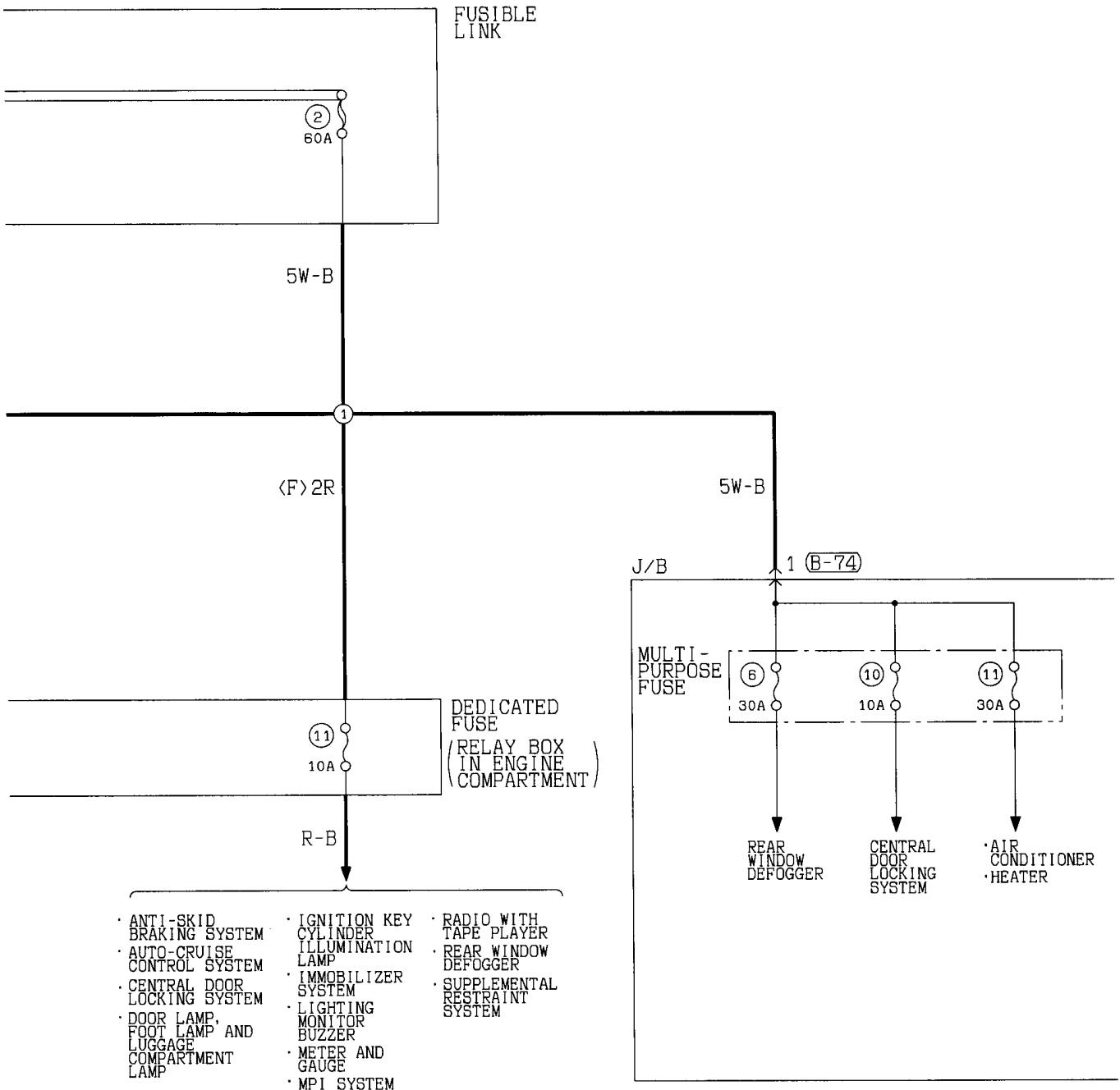

Wire colour code
 B:Black LG:Light green G:Green L:Blue W:White Y:Yellow SB:Sky blue
 BR:Brown O:Orange GR:Gray R:Red P:Pink V:Violet

POWER DISTRIBUTION SYSTEM (CONTINUED)

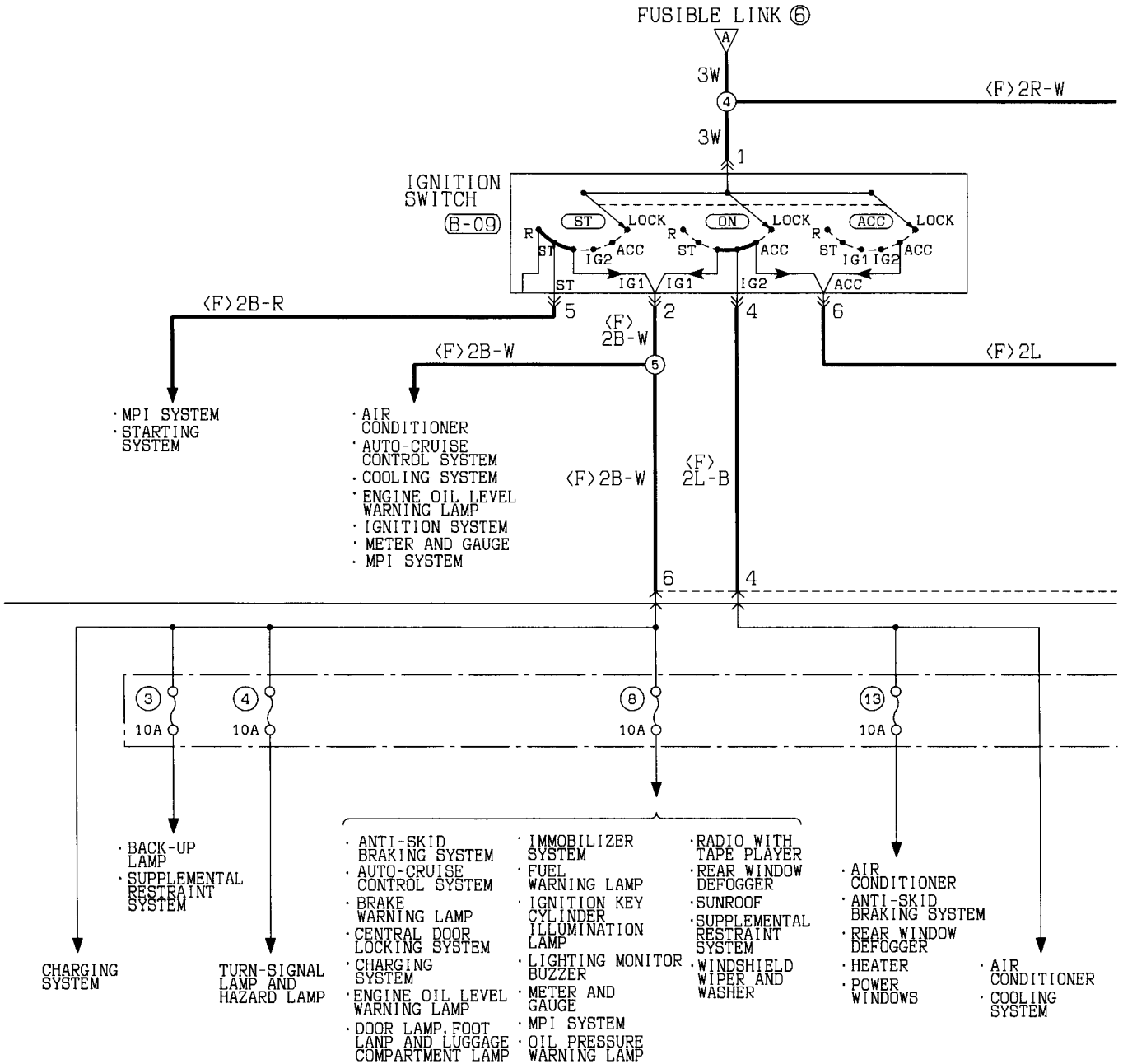

(B-09)

(B-49)

(B-75)

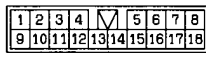
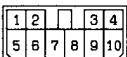

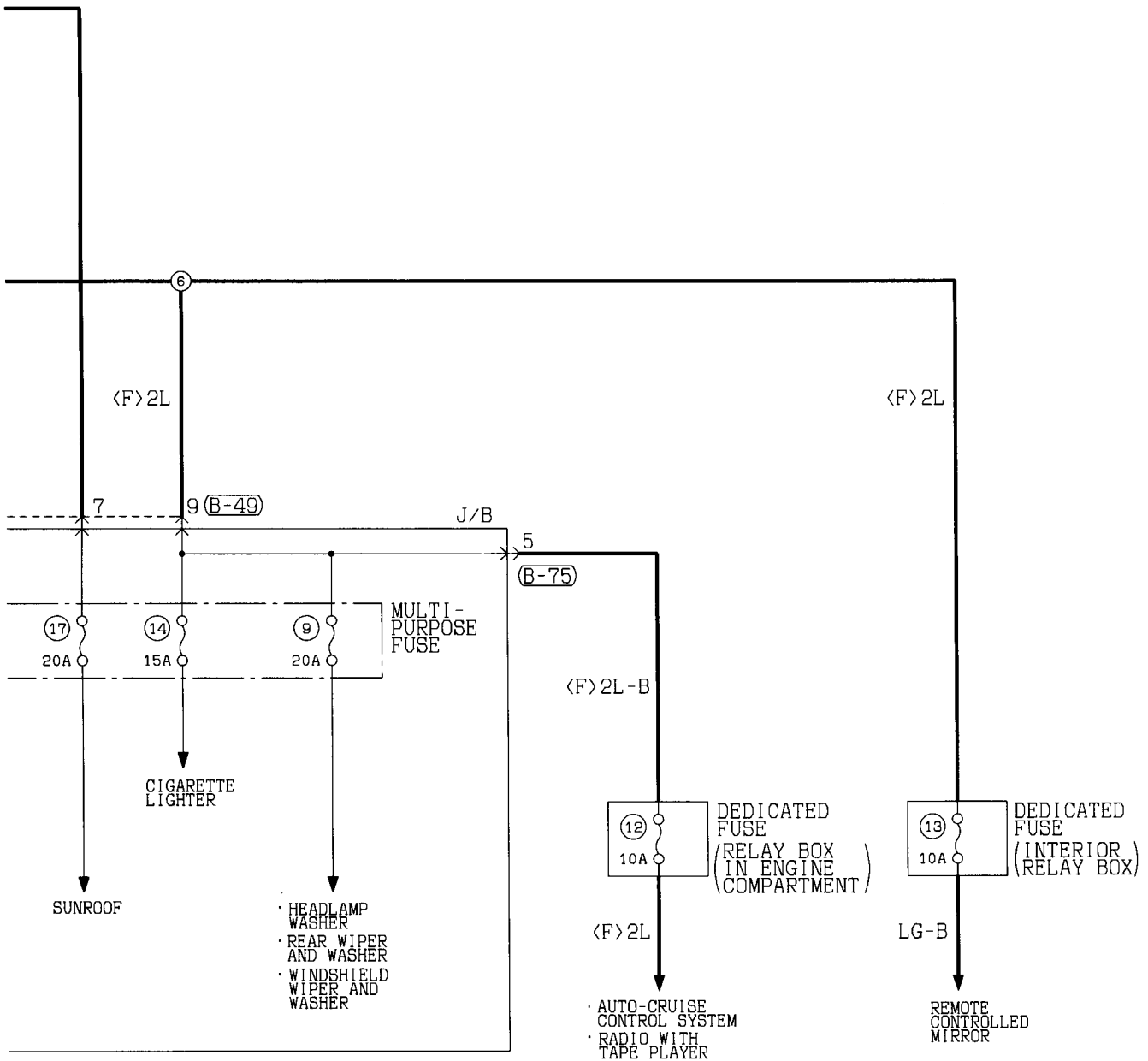

Wire colour code
 B:Black LG:Light green G:Green L:Blue W:White Y:Yellow SB:Sky blue
 BR:Brown O:Orange GR:Gray R:Red P:Pink V:Violet

STARTING SYSTEM

90100050282

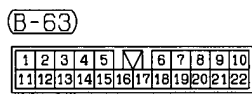
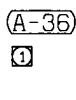
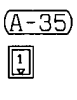
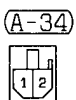
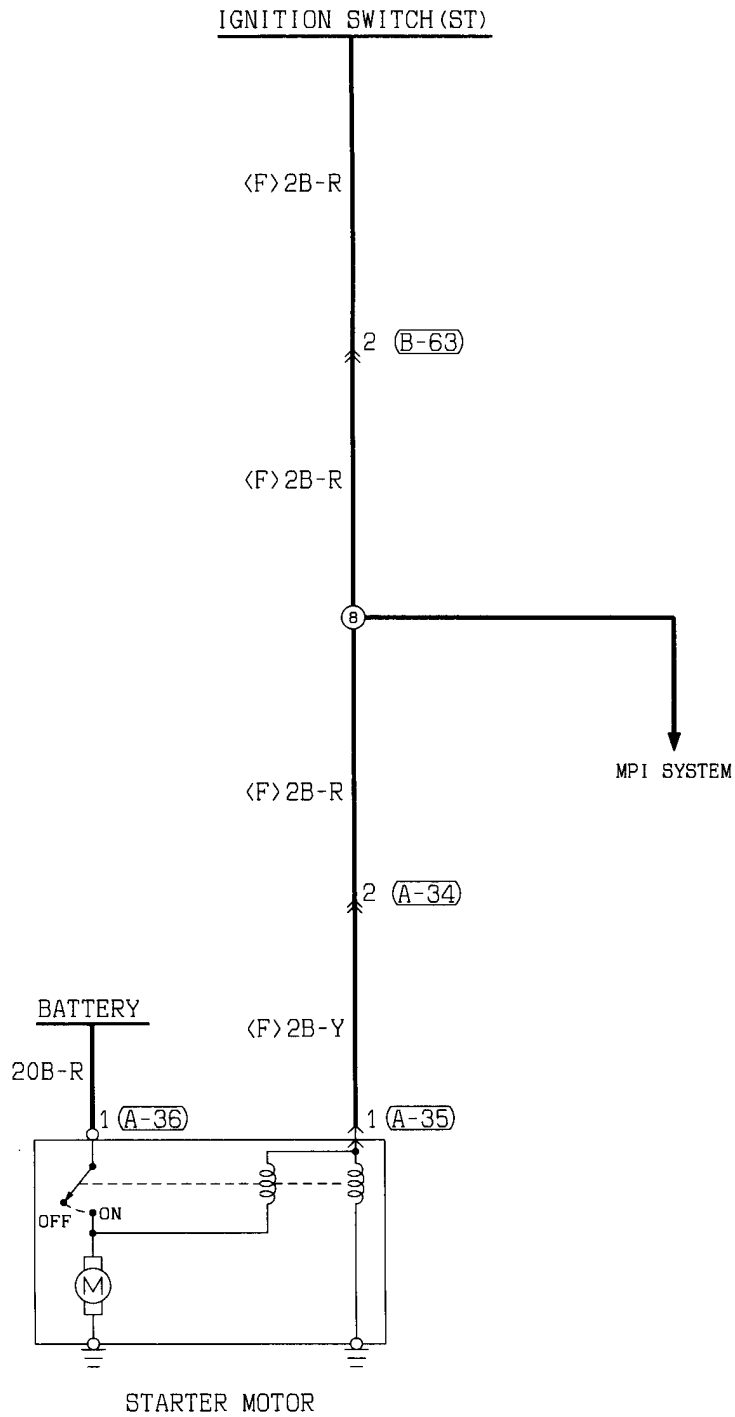

Wire colour code
 B:Black LG:Light green G:Green L:Blue W:White Y:Yellow SB:Sky blue
 BR:Brown O:Orange GR:Gray R:Red P:Pink V:Violet

CHARGING SYSTEM

90100070257

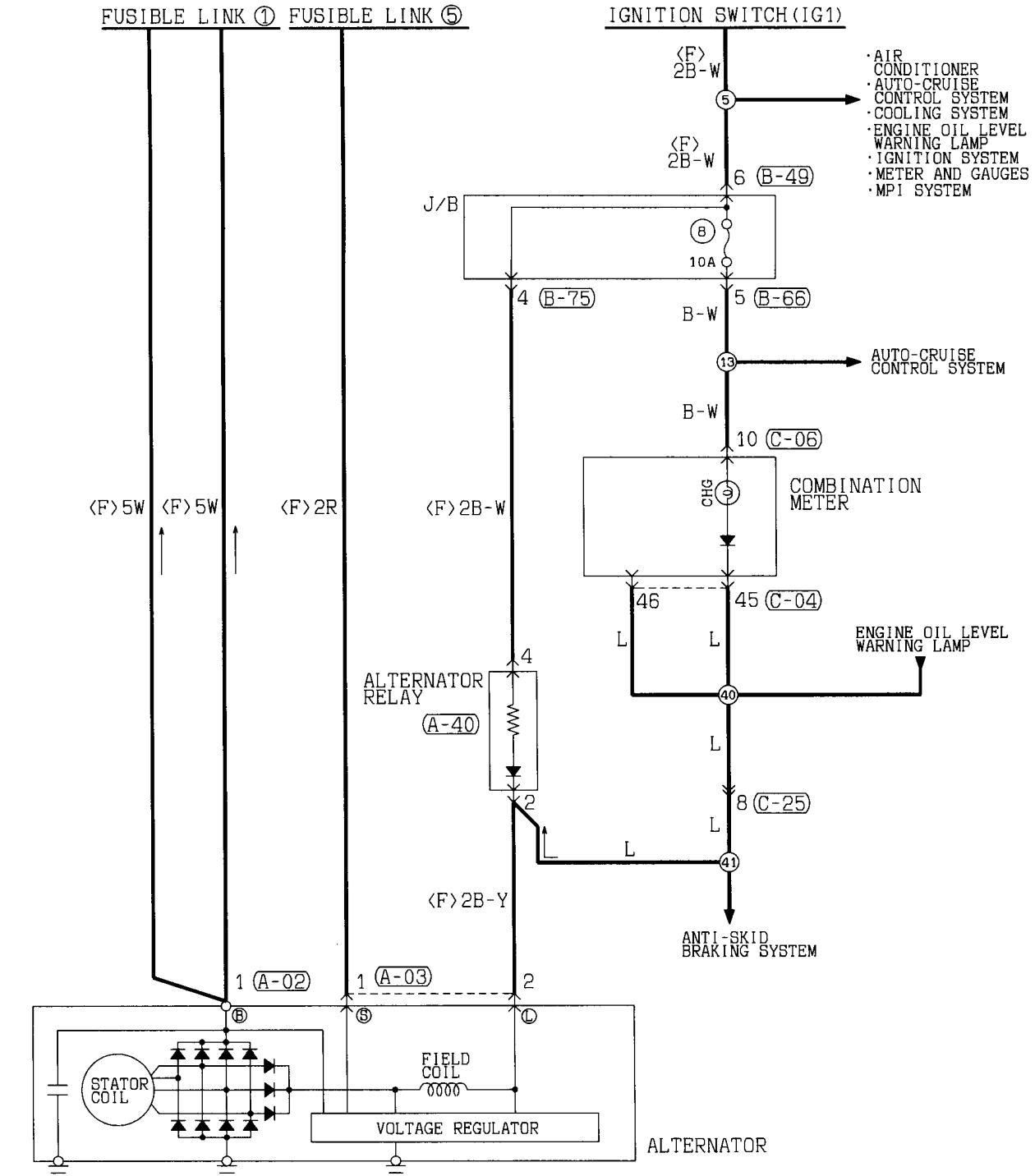

(A-02)	(A-03)	(A-40)	(B-49)	(B-66)	(B-75)	(C-04)	(C-06)
①	①②	1 2 3 4	1 2 3 4 5 6 7 8 9 10	1 2 3 4 5 6 7 8 9 10 11 12 13 14 15 16 17 18 19 20 21 22	1 2 3 4 5 6 7 8 9 10 11 12 13 14 15 16 17 18	41 42 43 44 45 46 47 76 49	1 2 3 4 5 6 7 8 9
						50 51 52 53 54 55 56 57	10 11 12 13 14 15 16 17

(C-25)

1 2 3 4 5 6 7 8 9 10

Wire colour code
 B:Black LG:Light green G:Green L:Blue W:White Y:Yellow SB:Sky blue
 BR:Brown O:Orange GR:Gray R:Red P:Pink V:Violet

CHARGING SYSTEM (See P. 4-18.)**OPERATION****When engine is stationary**

- When the ignition switch is turned to the ON position, current flows the alternator L terminal to the field coil and, at the same time, the charge warning lamp illuminates.

When engine is started and after engine has started

- When the engine is started, the charge warning lamp goes out because of the charging voltage begin applied to the alternator L terminal.
- The battery voltage being applied to the alternator S terminal is monitored by the voltage regulator. Therefore, the amount of electricity produced by the alternator is controlled by allowing and cutting off the current flowing to the field coil.
- The alternator B terminal supplies power to each load.

Remark

- The alternator relay is provided to back up the flow of current to the field coil when the charge warning lamp is burned out.

TROUBLESHOOTING HINTS

1. Charging indicator lamp does not illuminate when the ignition switch is turned to ON position, before the engine starts.
 - Check multi-purpose fuse No. (8)
 - Check the bulb.
2. Charging indicator lamp fails to switch off once the engine starts.
 - Check voltage regulator of alternator.
3. Discharged or overcharged battery.
 - Check voltage regulator of alternator.
4. Charge warning lamp illuminates dimly.
 - Check combination meter diode (for short circuit).

MPI SYSTEM

9010080403

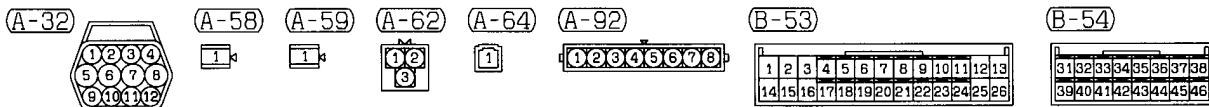
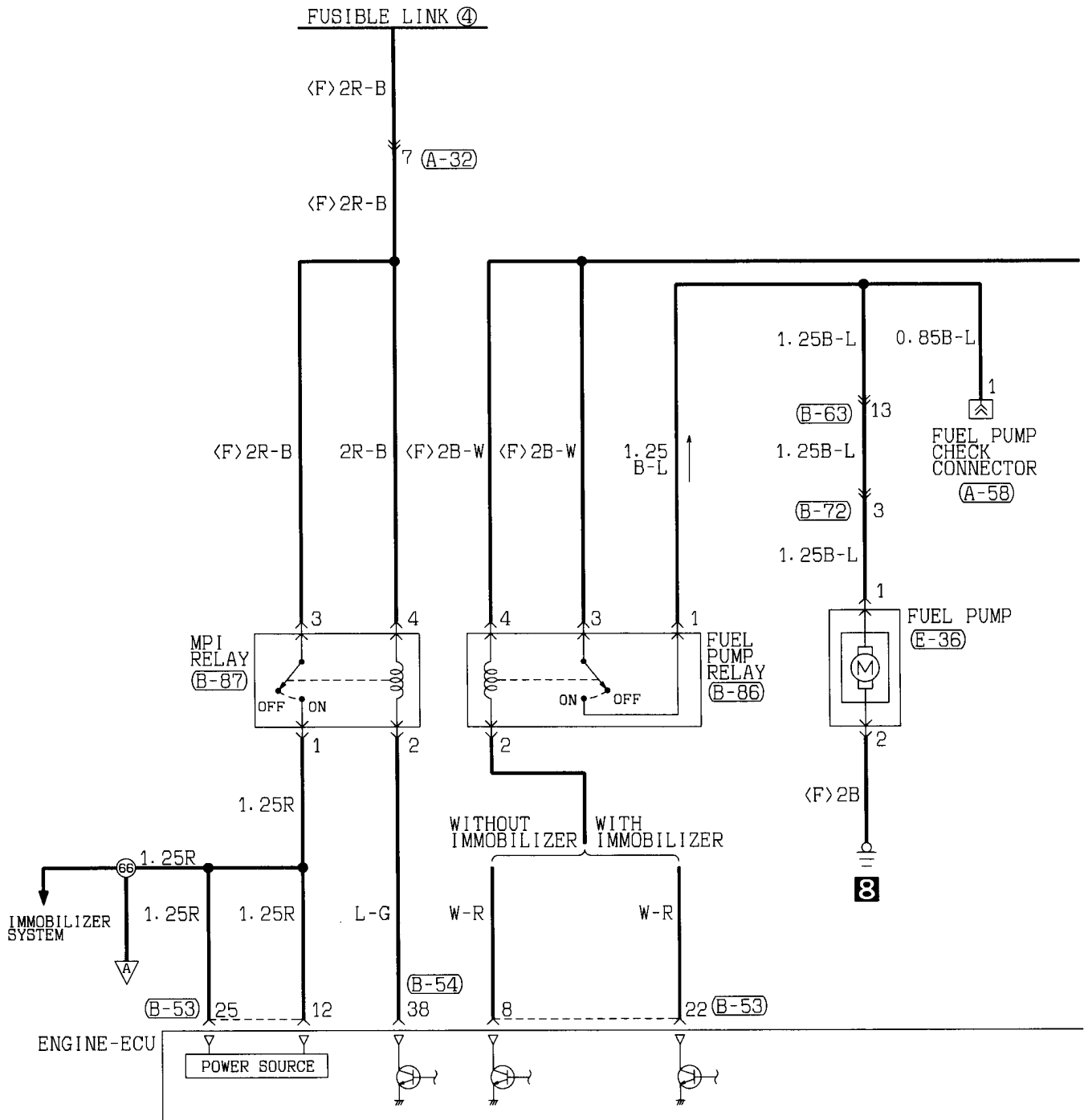

Wire colour code
 B:Black LG:Light green G:Green L:Blue W:White Y:Yellow SB:Sky blue
 BR:Brown O:Orange GR:Gray R:Red P:Pink V:Violet

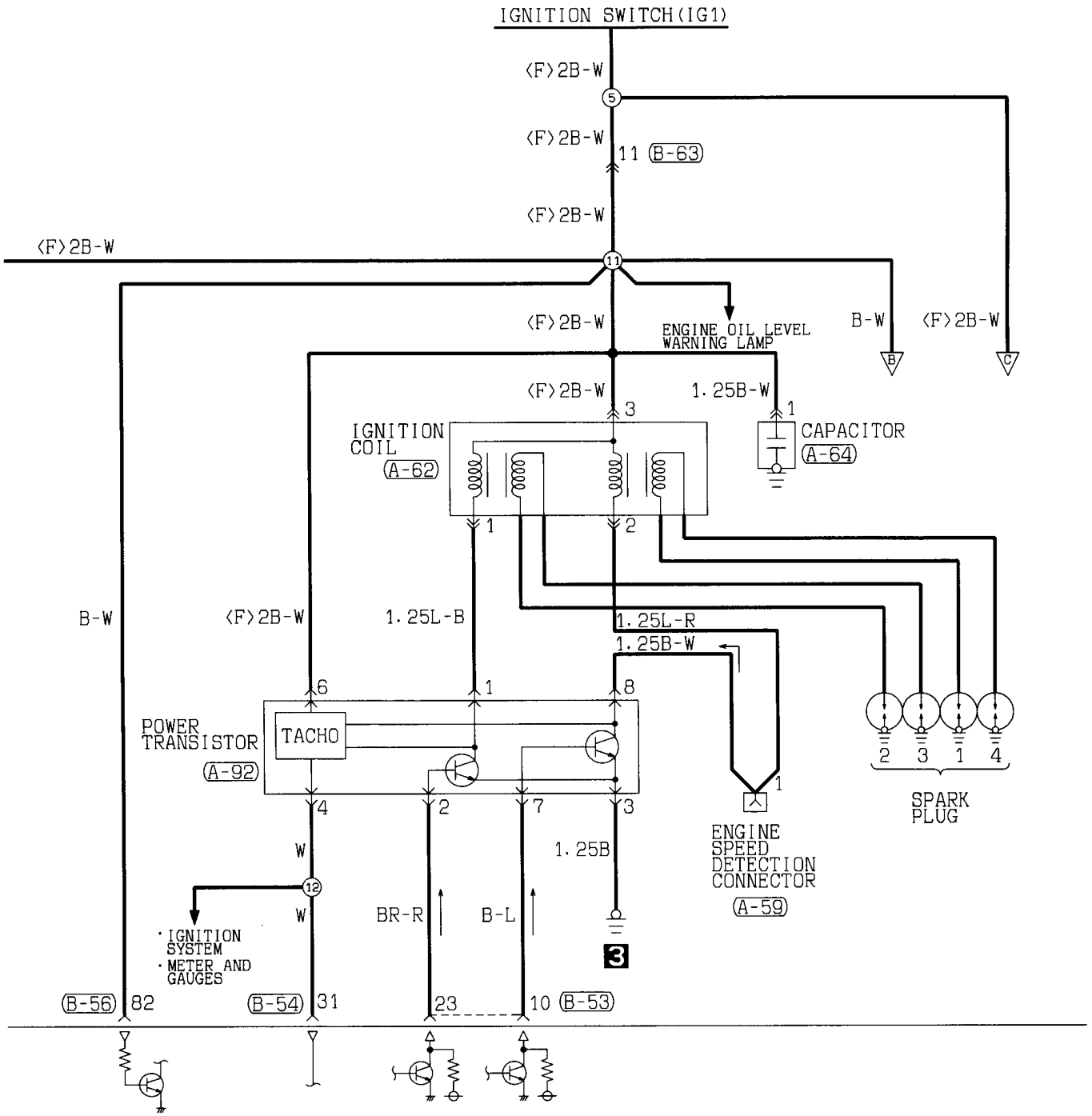

(B-56)

71	72	73	74	75	76	77	78	79	80	81
82	83	84	85	86	87	88	89	90	91	92

(B-63)

1	2	3	4	5	6	7	8	9	10		
11	12	13	14	15	16	17	18	19	20	21	22

(B-72)

1	2
3	4

(B-86)

1	2
3	4

(B-87)

1	2
3	4

(E-36)



MPI SYSTEM (CONTINUED)

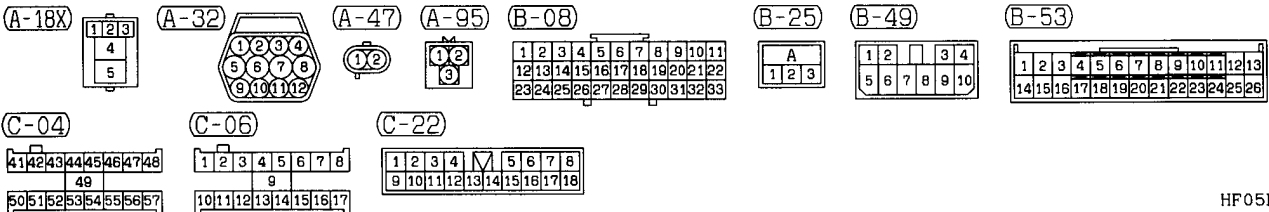
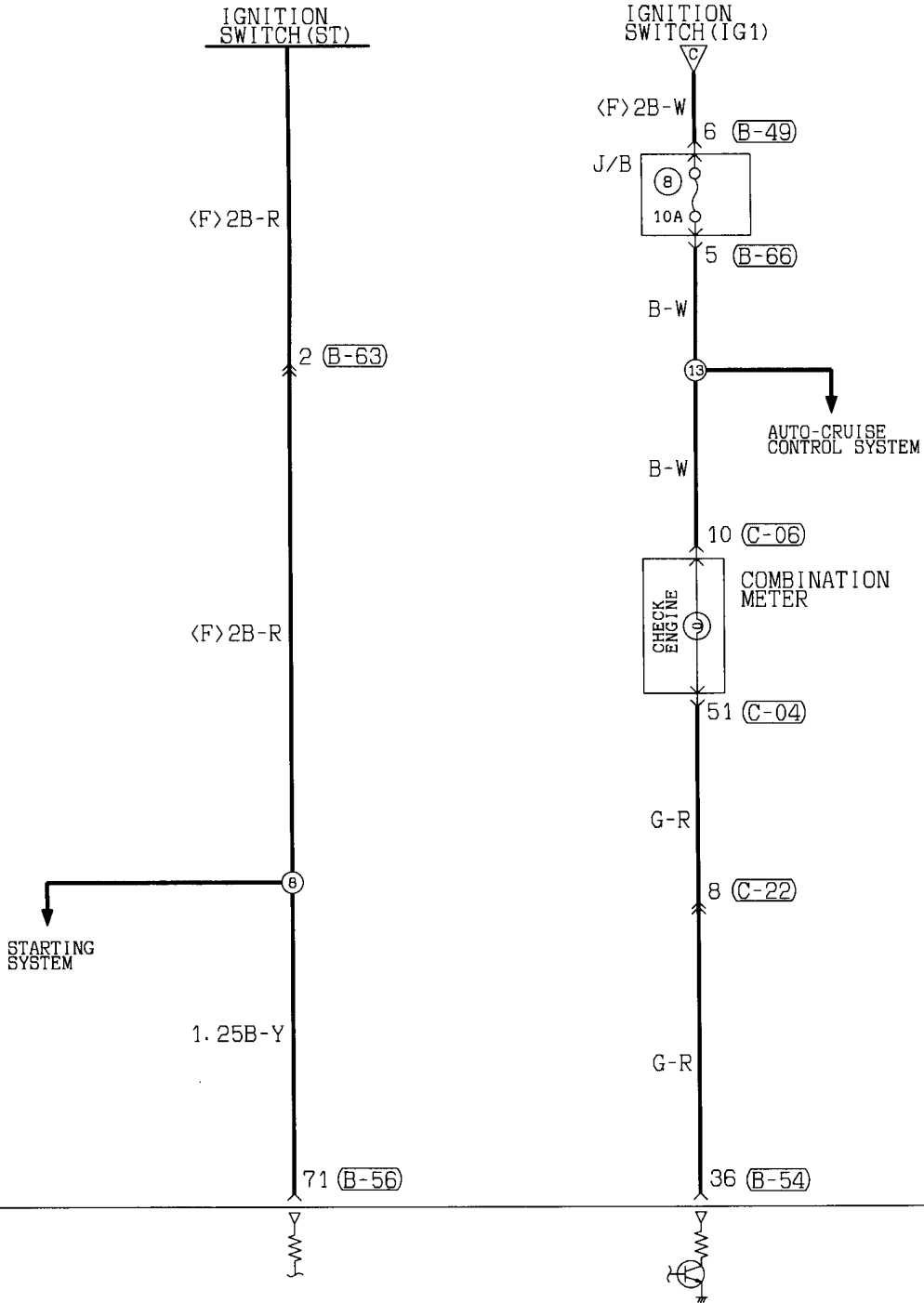

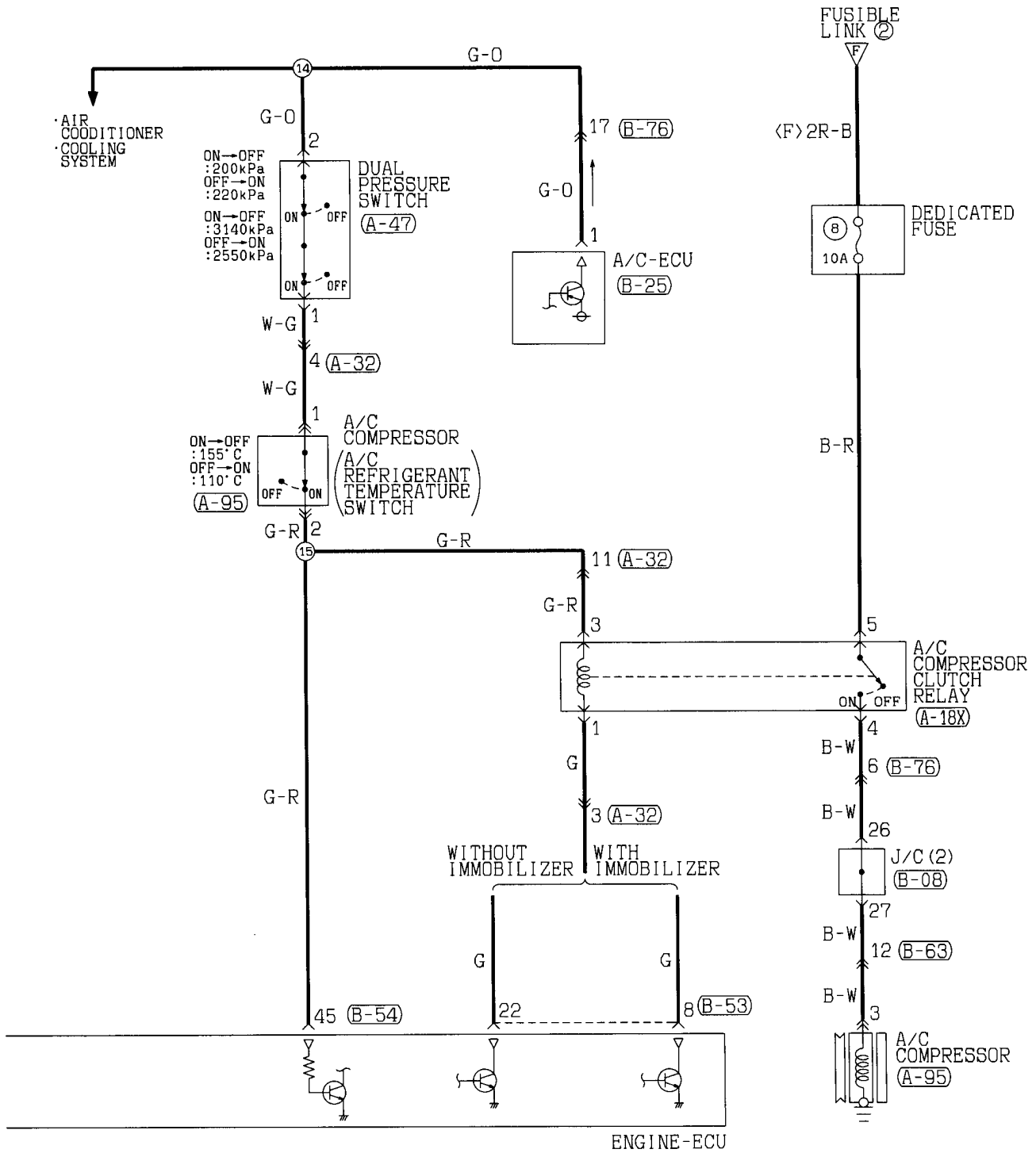

(B-54)

31	32	33	34	35	36	37	38
39	40	41	42	43	44	45	46

(B-56)

71	72	73	74	75	76	77	78	79	80	81
82	83	84	85	86	87	88	89	90	91	92

(B-63)

1	2	3	4	5	M	6	7	8	9	10	
11	12	13	14	15	16	17	18	19	20	21	22

(B-66)

1	2	3	4	5	M	6	7	8	9	10	
11	12	13	14	15	16	17	18	19	20	21	22

(B-76)

1	2	3	4	M	5	6	7	8	9	
10	11	12	13	14	15	16	17	18	19	20

Wire colour code
 B:Black LG:Light green G:Green L:Blue W:White Y:Yellow SB:Sky blue
 BR:Brown O:Orange GR:Gray R:Red P:Pink V:Violet

MPI SYSTEM (CONTINUED)

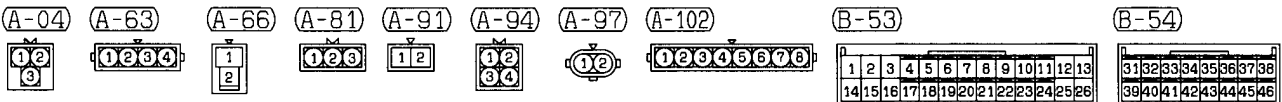
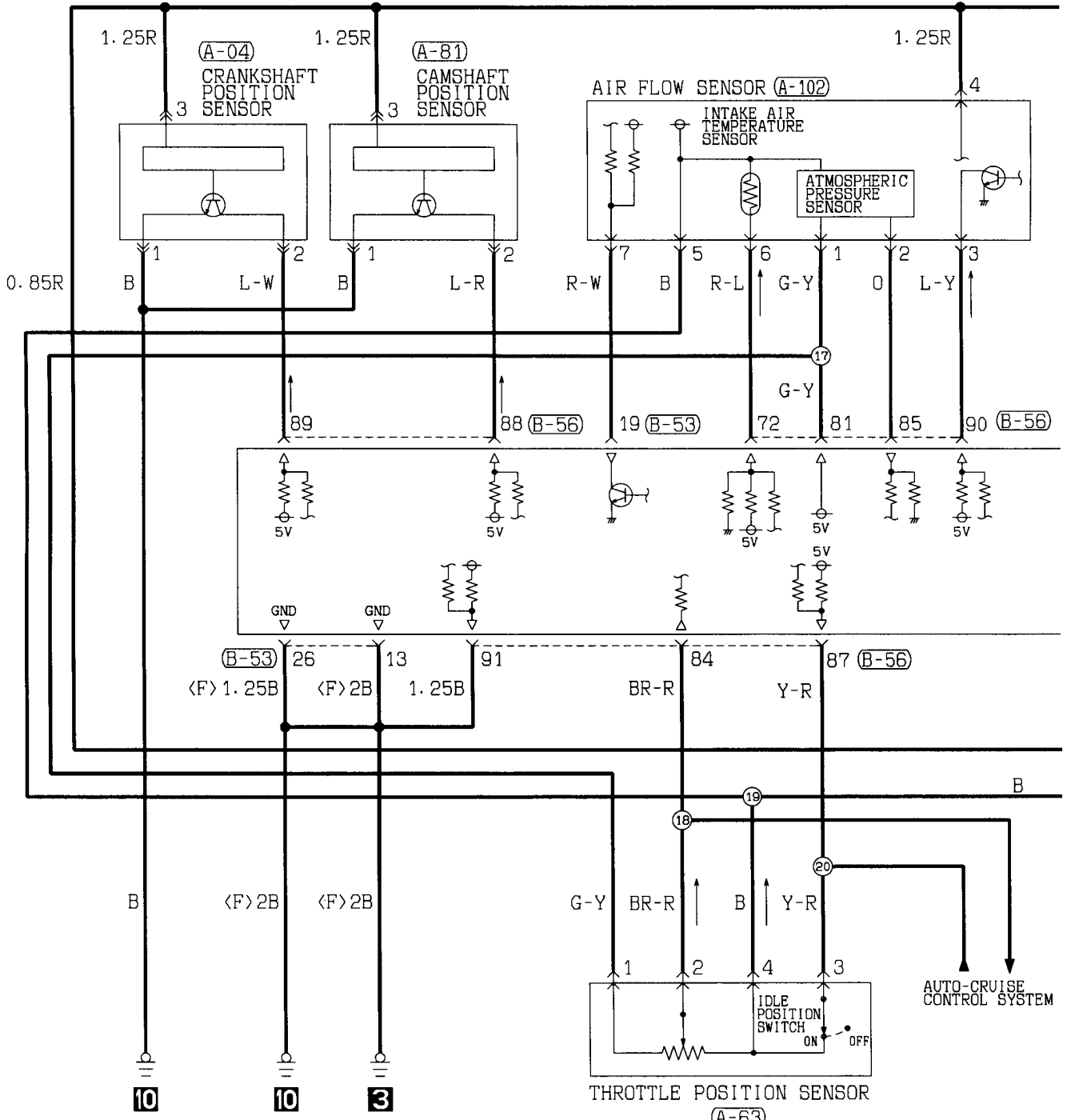

Wire colour code
 B:Black LG:Light green G:Green L:Blue W:White Y:Yellow SB:Sky blue
 BR:Brown O:Orange GR:Gray R:Red P:Pink V:Violet

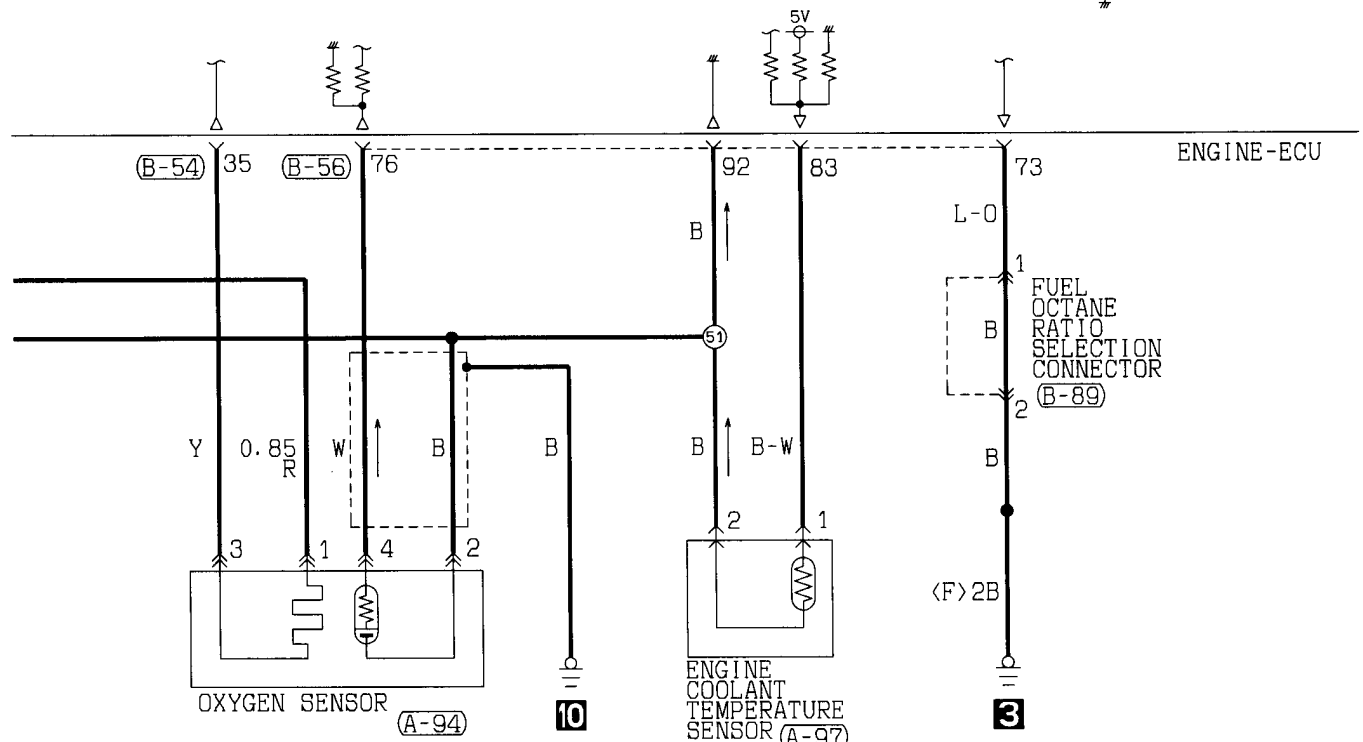
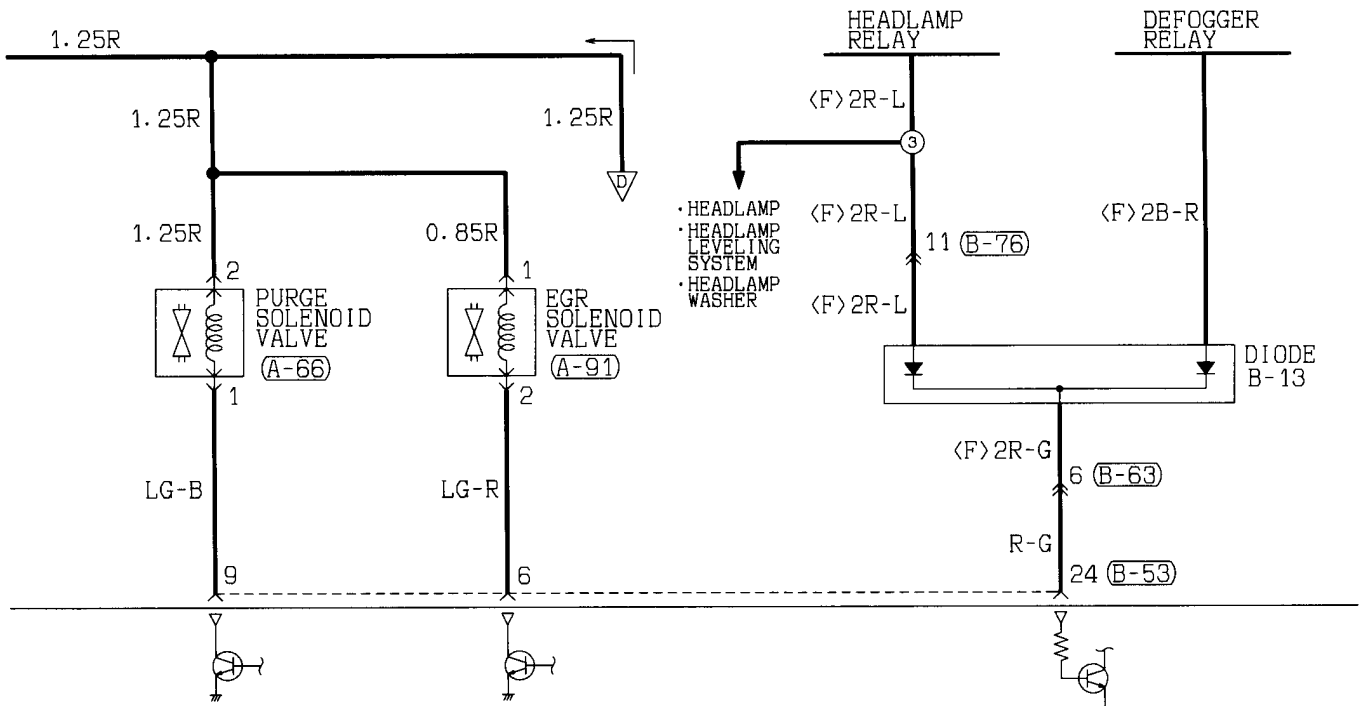

(B-56)

71	72	73	74	75	76	77	78	79	80	81
82	83	84	85	86	87	88	89	90	91	92

(B-63)

1	2	3	4	5	6	7	8	9	10		
11	12	13	14	15	16	17	18	19	20	21	22

(B-76)

1	2	3	4	5	6	7	8	9		
10	11	12	13	14	15	16	17	18	19	20

(B-89)

1
2

MPI SYSTEM (CONTINUED)

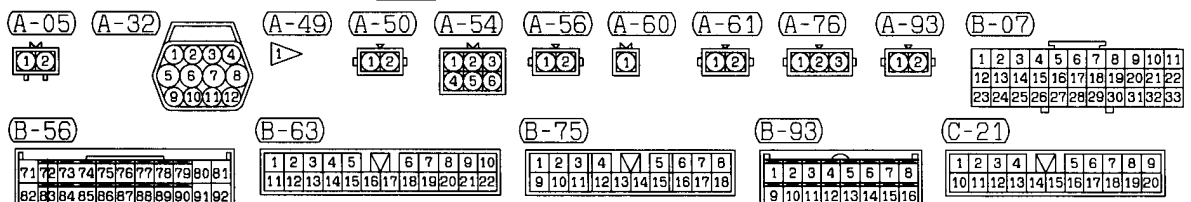
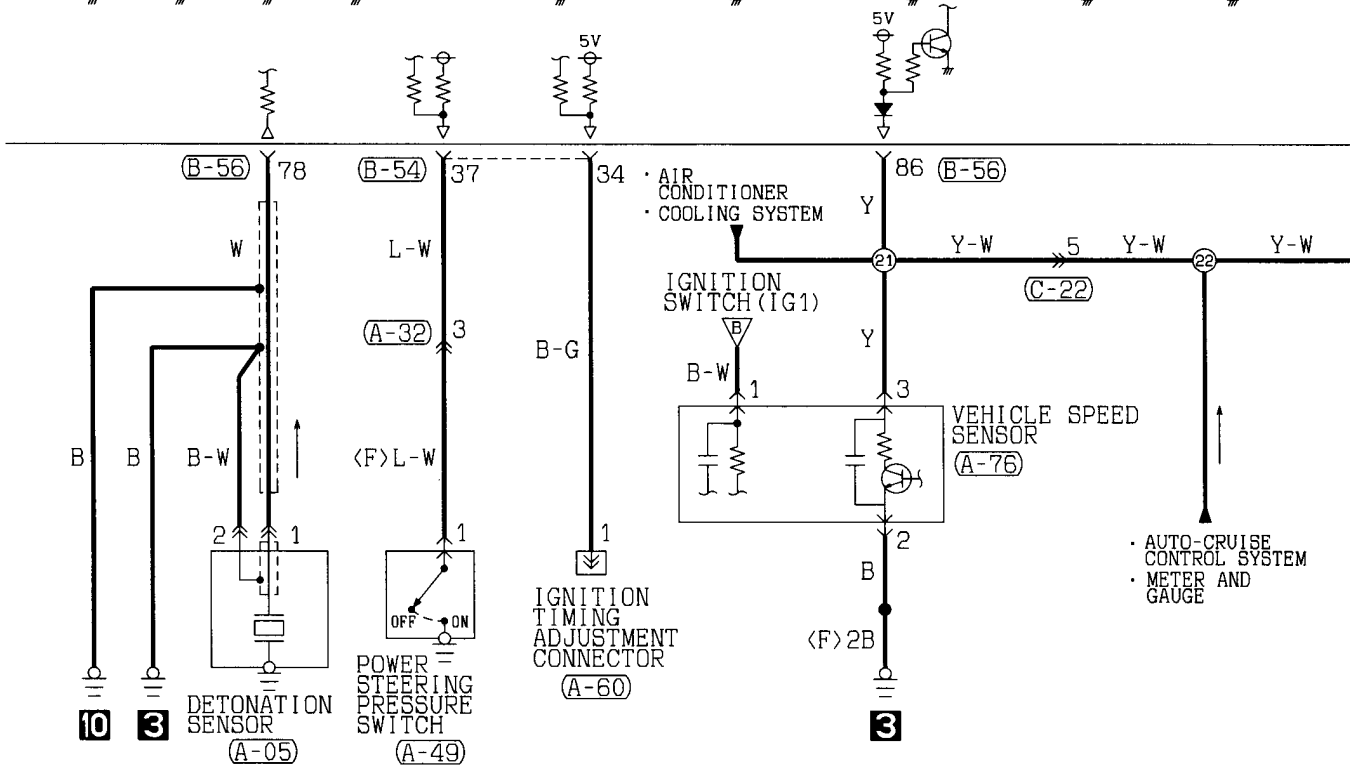
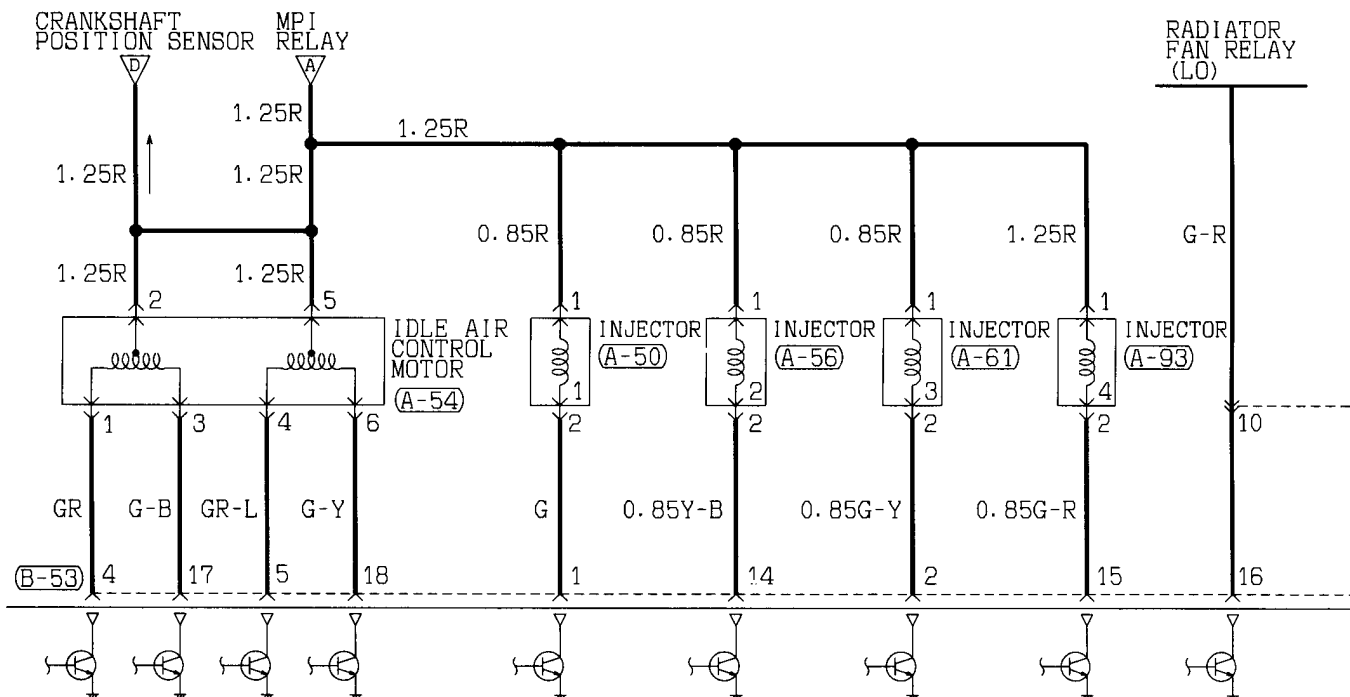

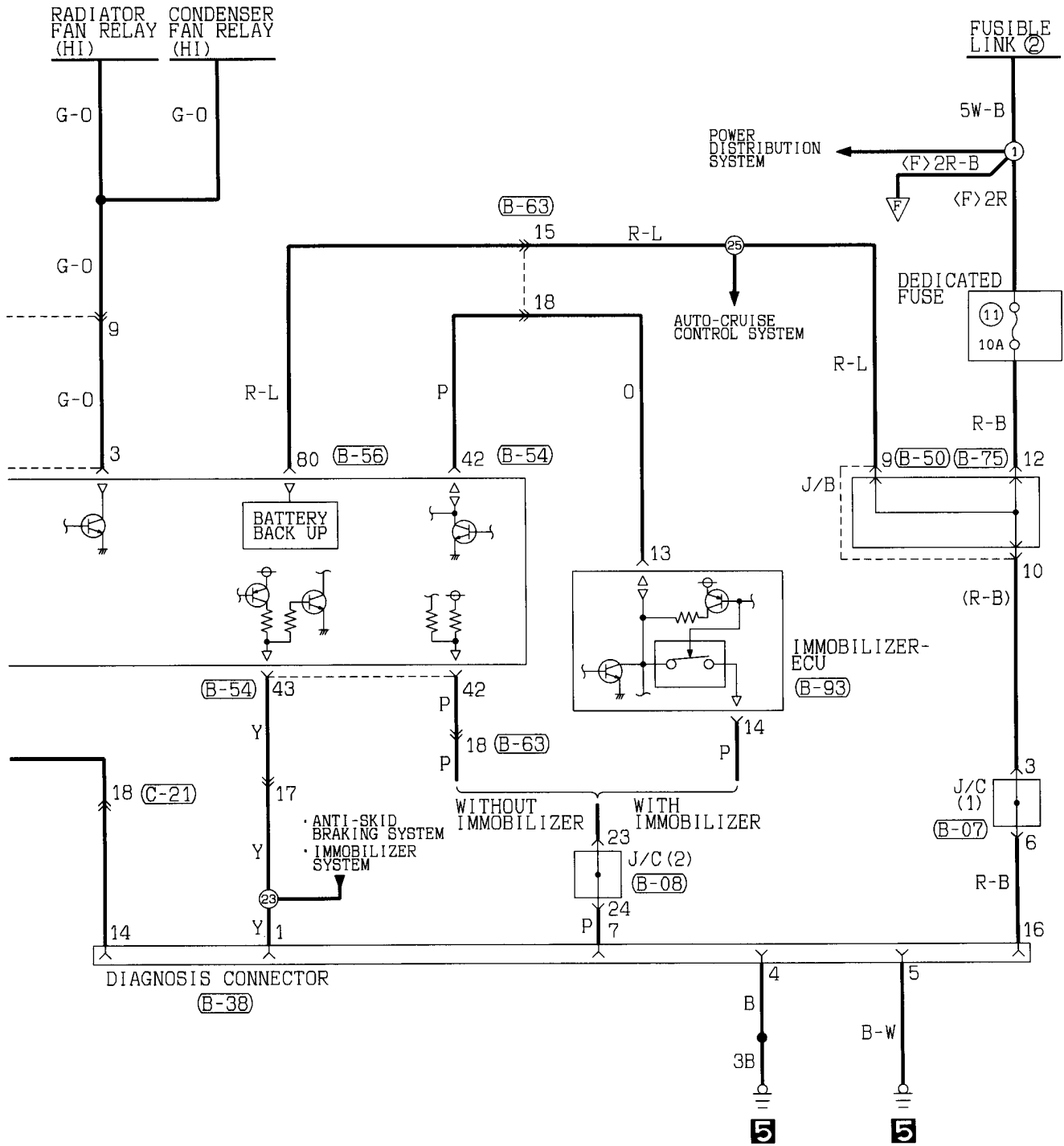

(B-08)

1	2	3	4	5	6	7	8	9	10	11
12	13	14	15	16	17	18	19	20	21	22
23	24	25	26	27	28	29	30	31	32	33

(C-22)

1	2	3	4	5	6	7	8		
9	10	11	12	13	14	15	16	17	18

(B-38) FRONT SIDE

1	2	3	4	5	6	7	8
9	10	11	12	13	14	15	16

(B-50)

1	2	3	4	5	6	7	8		
9	10	11	12	13	14	15	16	17	18

(B-53)

1	2	3	4	5	6	7	8	9	10	11	12	13
14	15	16	17	18	19	20	21	22	23	24	25	26

(B-54)

31	32	33	34	35	36	37	38
39	40	41	42	43	44	45	46

COOLING SYSTEM

90100100239

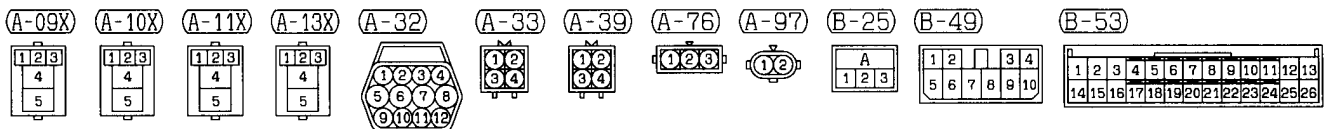
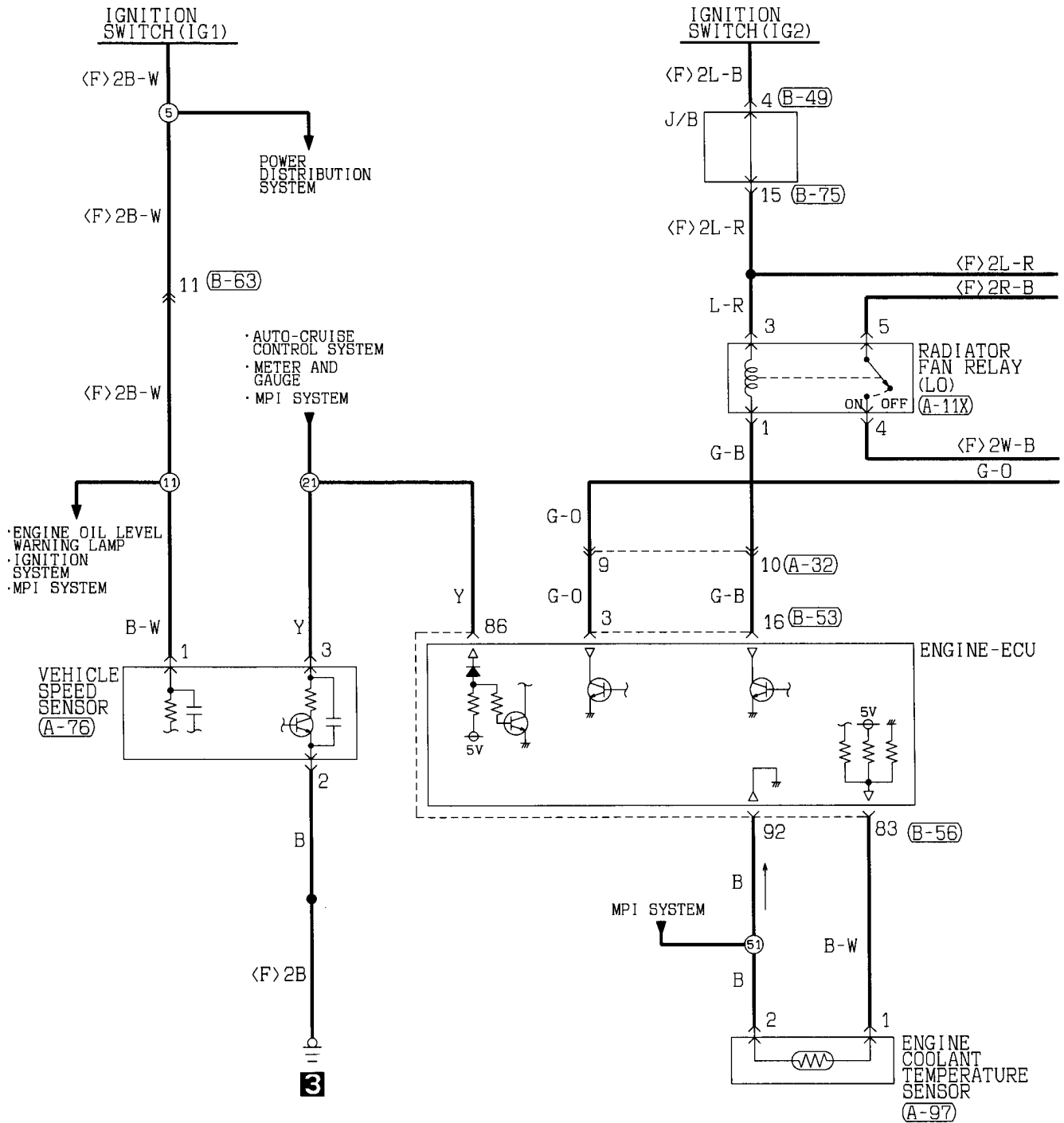

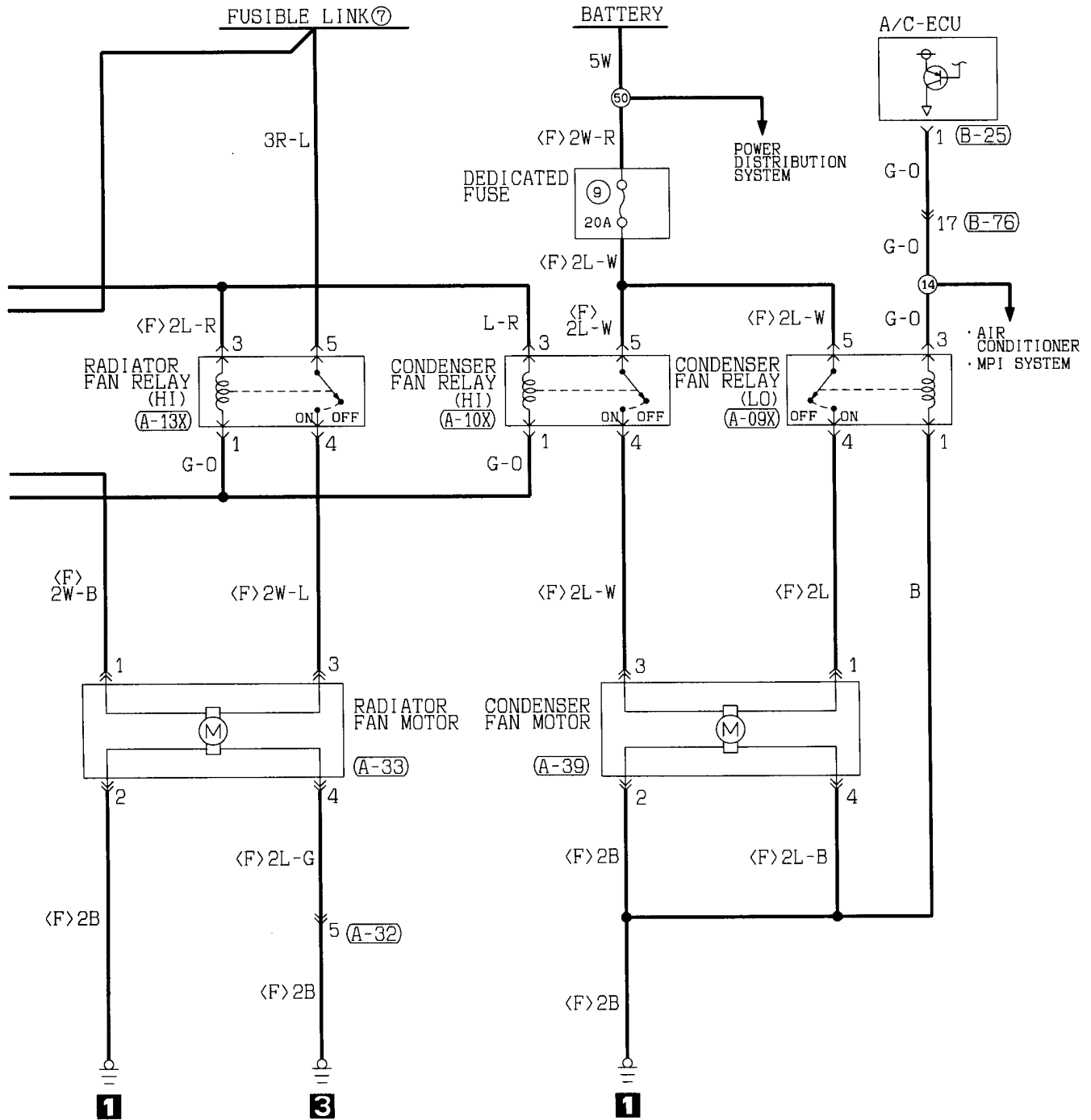

(B-56)

71	72	73	74	75	76	77	78	79	80	81
82	83	84	85	86	87	88	89	90	91	92

(B-63)

1	2	3	4	5	M	6	7	8	9	10	
11	12	13	14	15	16	17	18	19	20	21	22

(B-75)

1	2	3	4	M	5	6	7	8	
9	10	11	12	13	14	15	16	17	18

(B-76)

1	2	3	4	M	5	6	7	8	9	
10	11	12	13	14	15	16	17	18	19	20

Wire colour code
 B:Black LG:Light green G:Green L:Blue W:White Y:Yellow SB:Sky blue
 BR:Brown O:Orange GR:Gray R:Red P:Pink V:Violet

HEADLAMP

90100150180

Vehicles without daytime running lamp

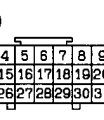
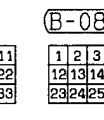
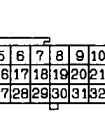
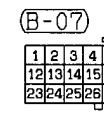
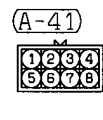
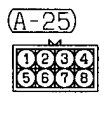
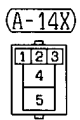
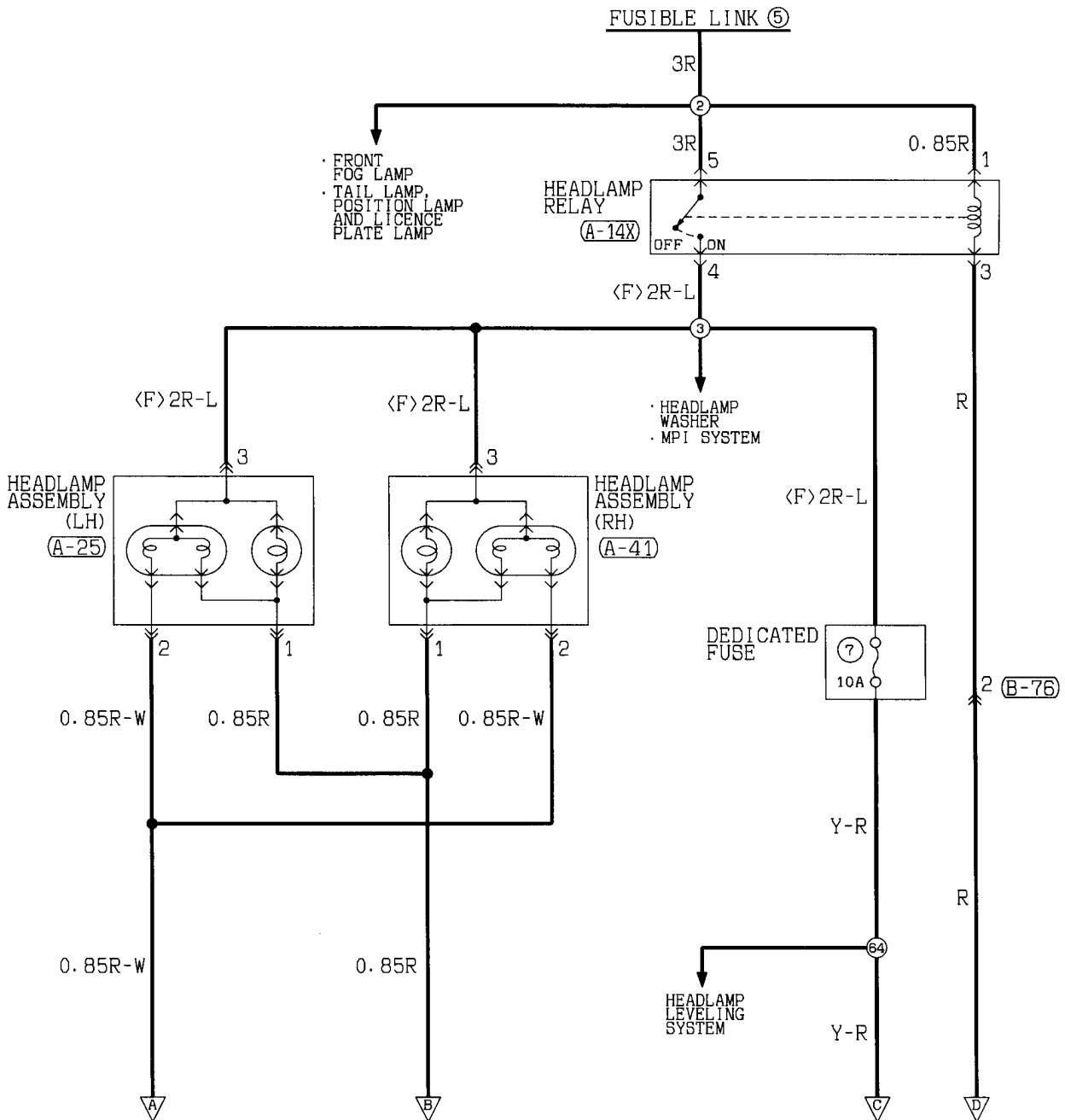

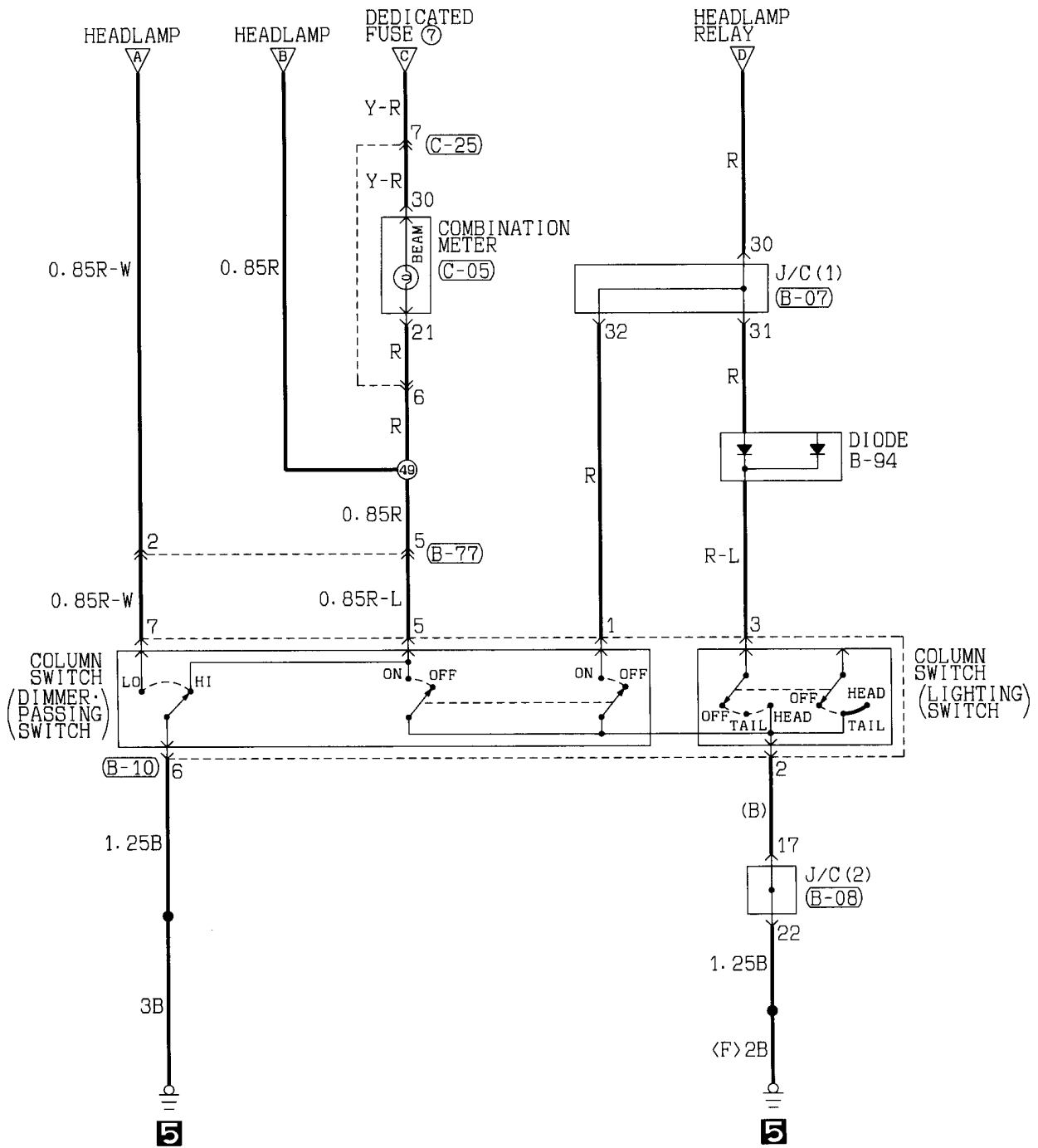

(B-77)

(C-05)

(C-25)

1	2	3
4	5	6
7	8	

21	22	23	24	25	26	27	28
				29			
30	31	32	33	34	35	36	37

1	2	3	4
5	6	7	8
9	10		

Wire colour code
 B:Black LG:Light green G:Green L:Blue W:White Y:Yellow SB:Sky blue
 BR:Brown O:Orange GR:Gray R:Red P:Pink V:Violet

HEADLAMP <Vehicles without daytime running lamp> (See P. 4-30.)

OPERATION

Headlamp Relay ON Conditions
Refer to the table below.

<Low-beam operation>

- Placing the lighting switch in the HEAD position causes the headlamp relay to be energized.
- If the dimmer/passing switch is placed in the LO position at this time, the headlamps light up in low beam.

<Upper-beam operation>

- Placing the lighting switch in the HEAD position causes the headlamp relay to be energized.
- If the dimmer/passing switch is placed in the HI position at this time, the headlamps light up in upper beam.

<Upper-beam indicator lamp>

- This lamp lights up when the upper/passing beams are on, indicating that the headlamps are on in upper beam.

<Passing operation>

- When the dimmer/passing switch is set to the "ON" position, the headlamp relay is switched ON and the upper beam of the headlamps illuminates.

TROUBLESHOOTING HINTS

1. Headlamps don't go on.
 - 1) But the tail lamps illuminate.
 - Check the headlamp relay.
 - Check the lighting switch.
 - 2) The tail lamps also don't illuminate.
 - Check the fusible link No. (5).
2. Both low beams don't illuminate.
 - Check the dimmer switch LO contacts.
3. Both upper beams don't illuminate.
 - 1) The passing signal functions OK.
 - Check the dimmer switch HI contacts.
4. One headlamp doesn't illuminate.
 - Check the lamp bulb.
5. Can't switch from low to upper beam or vice-versa.
 - Check the dimmer switch.
6. Upper-beam indicator lamp does not go on.
 - 1) Headlamp upper beams are operational.
 - Check dedicated fuse No. (7).
 - Check the indicator lamp bulb.

Lighting switch	Dimmer/passing switch	Headlamp relay
"HEAD"	—	ON
—	ON	ON

HEADLAMP <Vehicles with daytime running lamp> (See P. 4-34.)

OPERATION

Headlamp Relay ON Conditions
Refer to the table below.

<Daytime running lamp operation>

- Turning the ignition switch to the ON position causes the headlamp relay, daytime running lamp relay (1), and tail lamp relay to be energized, which causes the headlamps, tail lamps, etc. to go on.

<Low-beam operation>

- Placing the lighting switch in the HEAD position causes the headlamp relay and daytime running lamp relay (2) to be energized.
- If the dimmer/passing switch is placed in the LO position at this time, the headlamps light up in low beam.

<Upper-beam operation>

- Placing the lighting switch in the HEAD position causes the headlamp relay and daytime running lamp relay (2) to be energized.
- If the dimmer/passing switch is placed in the HI position at this time, the headlamps light up in upper beam.

<Upper-beam indicator lamp>

- This lamp lights up when the upper/passing beams are on, indicating that the headlamps are on in upper beam.

<Passing operation>

- When the dimmer/passing switch is set to the "ON" position, the headlamp relay is switched ON and the upper beam of the headlamps illuminates.

TROUBLESHOOTING HINTS

1. Headlamps don't go on.
 - 1) But the tail lamps do illuminate.
 - Check the headlamp relay.
 - Check the lighting switch.
 - 2) The tail lamps also don't illuminate.
 - Check the fusible link No. (6).
 - Check the DRL-ECU.
2. Both low beams don't illuminate.
 - Check the dimmer switch LO contacts.
 - Check the DRL relay (1).
3. Both upper beams don't illuminate.
 - 1) The passing signal functions OK.
 - Check the dimmer switch HI contacts.
 - 1) The passing signal doesn't function.
 - Check the dimmer switch.
 - Check the daytime running lamp relay (2).
 - Check the DRL-ECU.
4. One headlamp doesn't illuminate.
 - Check the lamp bulb.
5. Can't switch from low to upper beam or vice-versa.
 - Check the dimmer switch.
6. With the ignition switch at the "ON" position, the headlamps' low beam does not illuminate.
 - Check the daytime running lamp relay (1).
 - Check the DRL-ECU.
7. Upper-beam indicator lamp does not go on.
 - 1) Headlamp upper beams are operational.
 - Check dedicated fuse No. (7).
 - Check the indicator lamp bulb.

Ignition switch	Lighting switch	Dimmer/passing switch	Headlamp relay
"ON"	"OFF"	—	ON
—	"HEAD"	—	ON
—	—	"PASS"	ON

HEADLAMP

90100150197

Vehicles with daytime running lamp

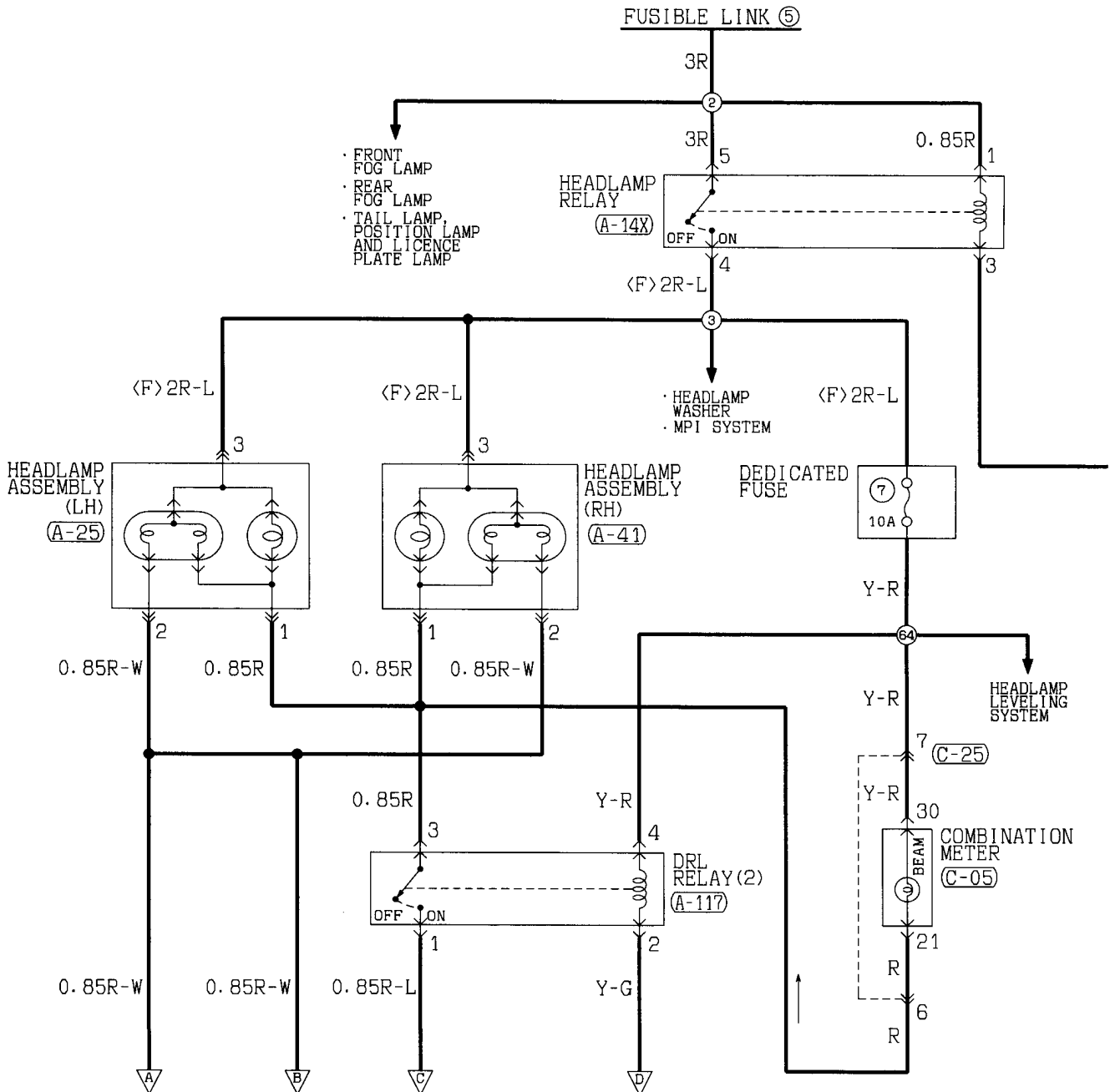

(A-14X)

(A-25)

(A-41)

(A-27)

(A-116)

(A-117)

(B-49)

(B-75)

(B-76)

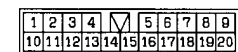
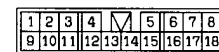
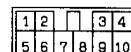
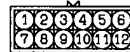

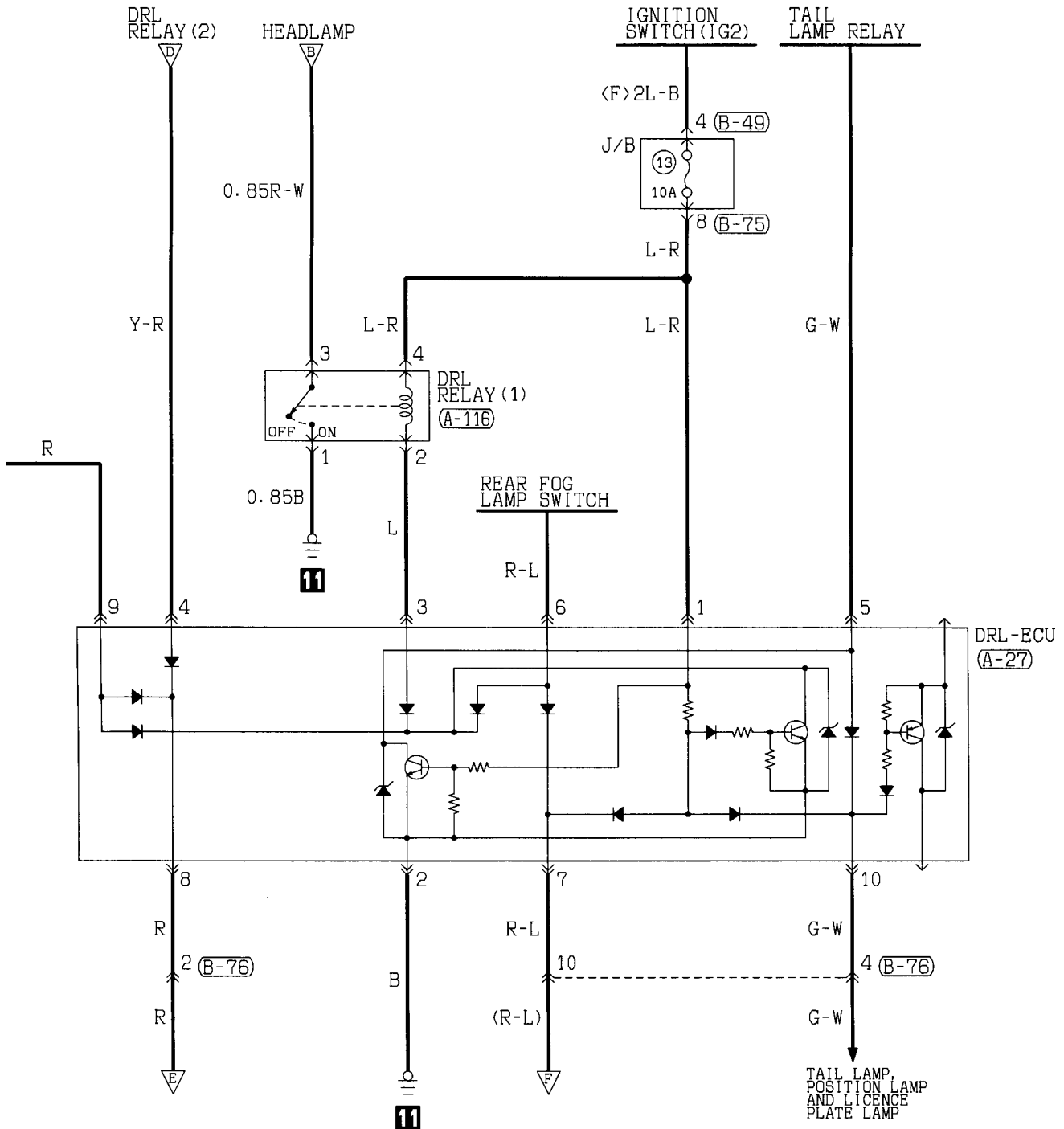

(C-05)

21	22	23	24	25	26	27	28
			29				
30	31	32	33	34	35	36	37

(C-25)

1	2	3	4
5	6	7	8
9	10		

Wire colour code
 B:Black LG:Light green G:Green L:Blue W:White Y:Yellow SB:Sky blue
 BR:Brown O:Orange GR:Gray R:Red P:Pink V:Violet

HEADLAMP <Vehicles with daytime running lamp> (CONTINUED)

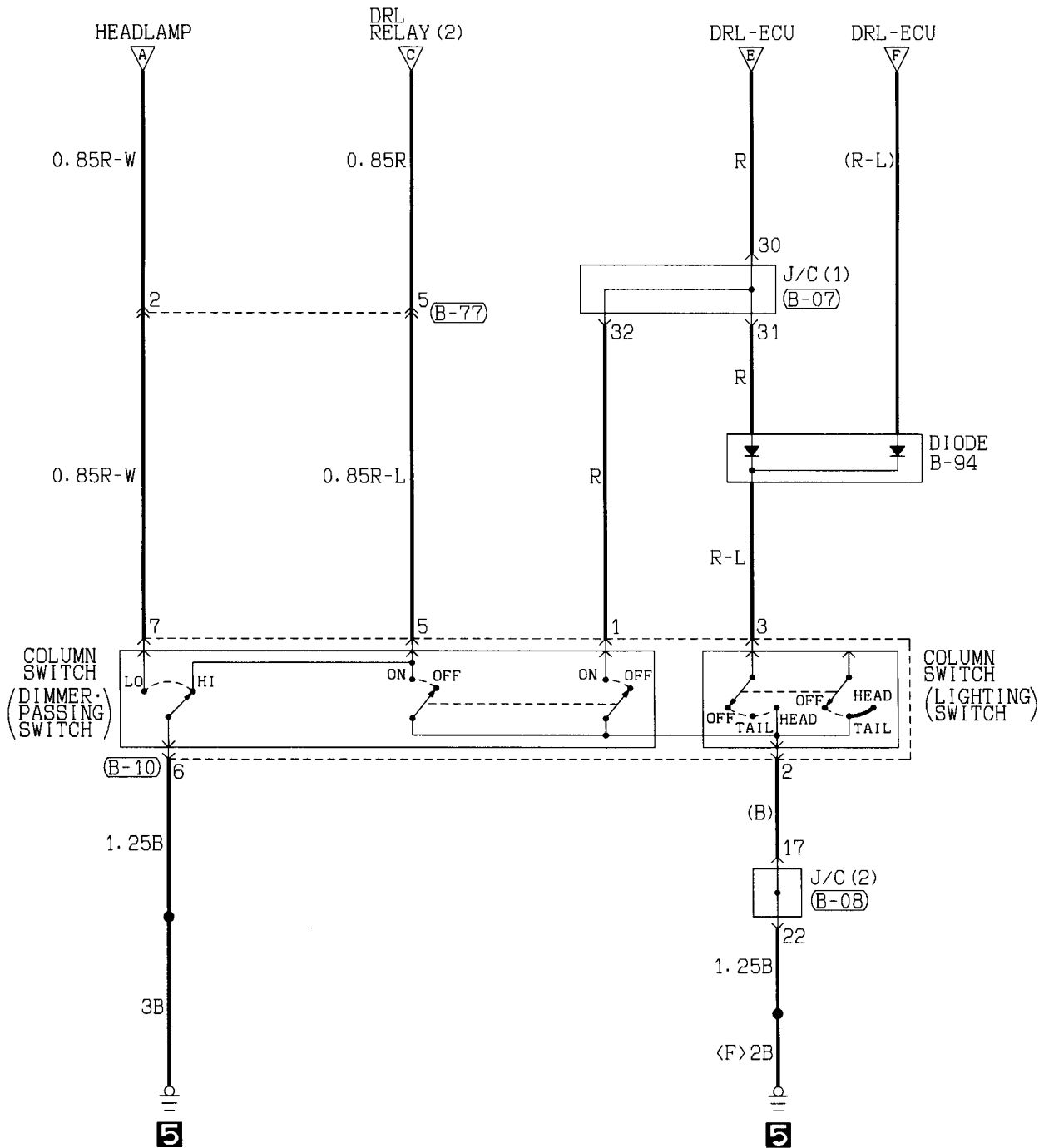

(B-07)

1	2	3	4	5	6	7	8	9	10	11
12	13	14	15	16	17	18	19	20	21	22
23	24	25	26	27	28	29	30	31	32	33

(B-08)

1	2	3	4	5	6	7	8	9	10	11
12	13	14	15	16	17	18	19	20	21	22
23	24	25	26	27	28	29	30	31	32	33

(B-10)

1	2	3	4
5	6	7	

(B-77)

1	2	3
4	5	6
7	8	

Wire colour code
 B:Black LG:Light green G:Green L:Blue W:White Y:Yellow SB:Sky blue
 BR:Brown O:Orange GR:Gray R:Red P:Pink V:Violet

HEADLAMP LEVELING SYSTEM (See P. 4-38.)**OPERATION****1. Headlamps angle-downwards operation**

- When the lighting switch is set to the "HEAD" position, the headlamp relay is switched ON, and battery voltage is applied, through the headlamp assembly, to dedicated fuse No. (7).
- When the headlamp-leveling switch setting is changed from "0" to "1", the positive (+) input terminal voltage of the comparator OP AMP 1 (located within the headlamp assembly) becomes greater than the negative (-) input terminal standard reference voltage value, and OP AMP 1 outputs HIGH signals to OP AMP 2 and OP AMP 3.
- As a result of these HIGH signals, OP AMP 2 outputs LOW signals and OP AMP 3 outputs HIGH signals to the motor-control IC.
- When this happens, the motor-control IC is switched ON, current flows to the motor, and the motor rotates forwards.
- The rotation of the motor, after passing through the gears and the output shaft, causes the headlamp reflectors to move to a downward angle, thus changing the angle of headlamp illumination.
- At this time, the position-detection sliding resistance is activated in the direction of the low resistance value, after which the OP AMP 1 negative (-) input terminal voltage value and positive (+) input terminal voltage value become equivalent, and OP AMP 2 and OP AMP 3 both output HIGH signals.
- When this happen, the motor-control IC is switched OFF and the motor stops.

NOTE

- (1) The same operation occurs if the headlamp-leveling switch is set to another position.
- (2) The input open protection circuit functions to stop the operation of the motor if there is an abnormal condition, such as damaged or disconnected wiring within the headlamp assembly or of the wiring harness.

2. Headlamps angle-upwards operation

- The headlamp angle-upwards operation is the opposite logic of the downwards operation; the motor operates in the reverse direction and then stops.

TROUBLESHOOTING HINTS

1. Absolutely no change of the headlamp angle
 - (1) The upper-beam indicator lamp illuminates.
 - Check the headlamp-leveling switch.
 - Check the headlamp assembly.
 - (2) The upper-beam indicator lamp does not illuminate.
 - Check dedicated fuse No. (7).
2. There is one setting of the headlamp-leveling switch at which the headlamp angle does not change.
 - Check the headlamp-leveling switch.

HEADLAMP LEVELING SYSTEM

90101250070

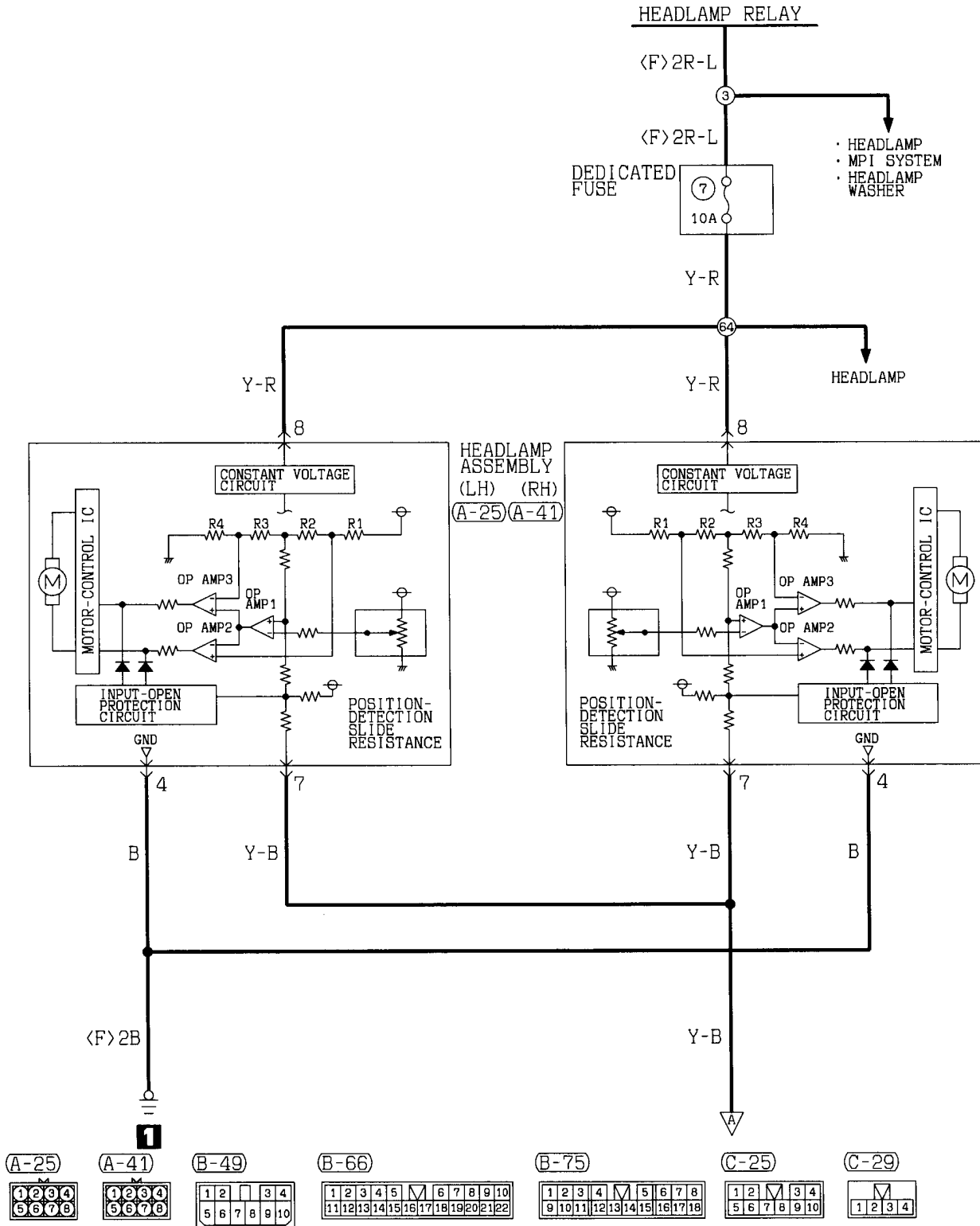

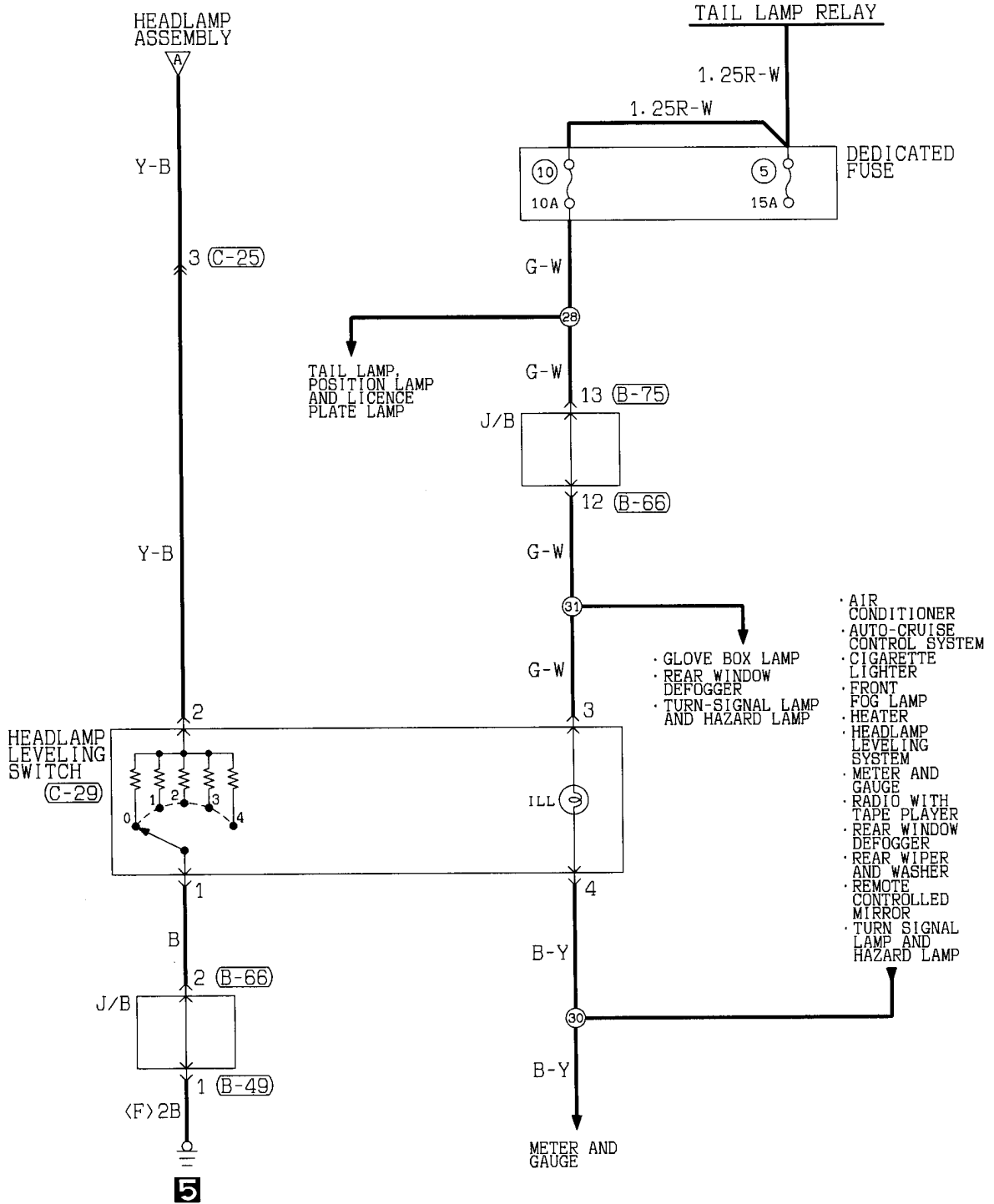

Wire colour code
 B:Black LG:Light green G:Green L:Blue W:White Y:Yellow SB:Sky blue
 BR:Brown O:Orange GR:Gray R:Red P:Pink V:Violet

TAIL LAMP, POSITION LAMP AND LICENCE PLATE LAMP

90101280080

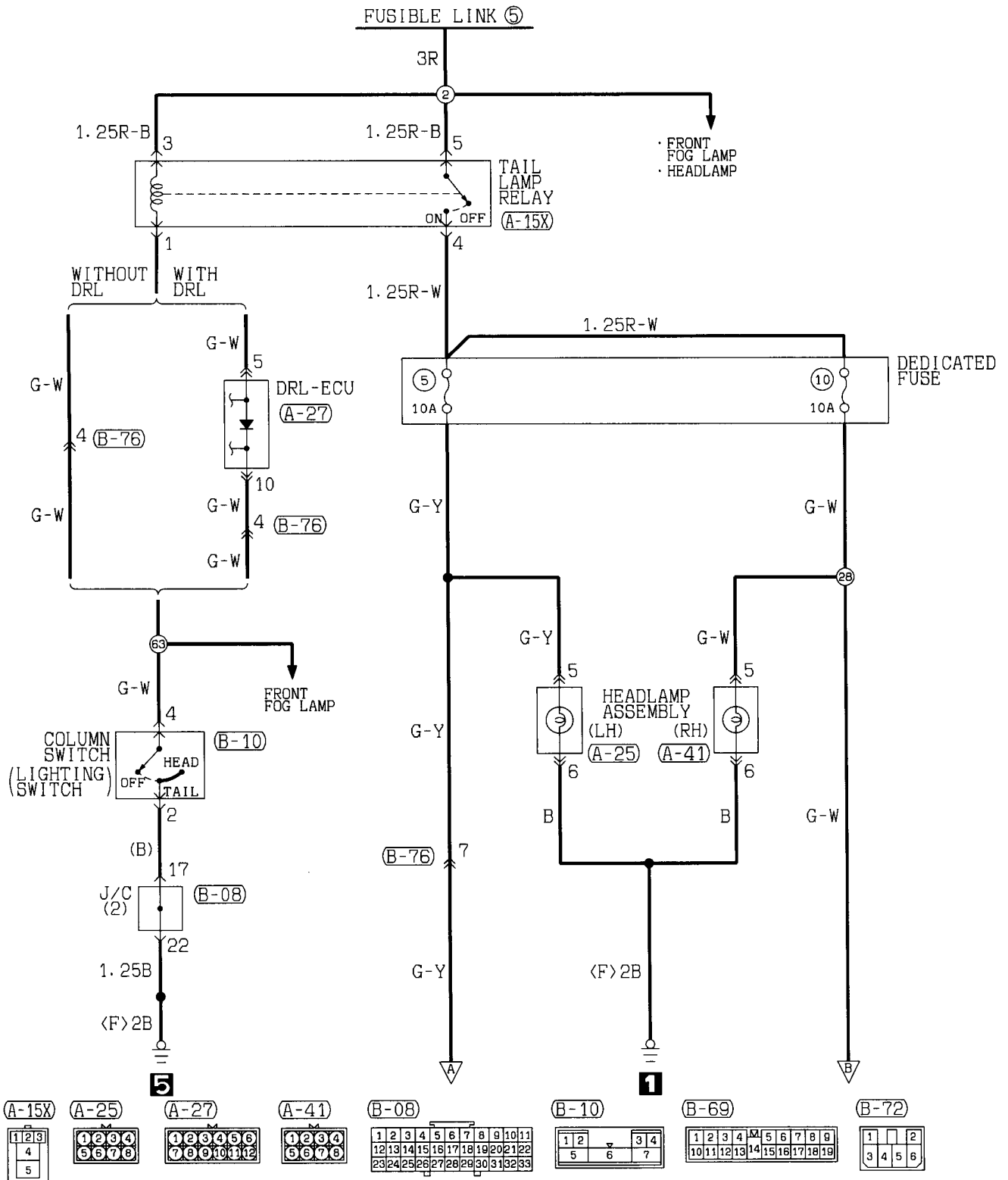

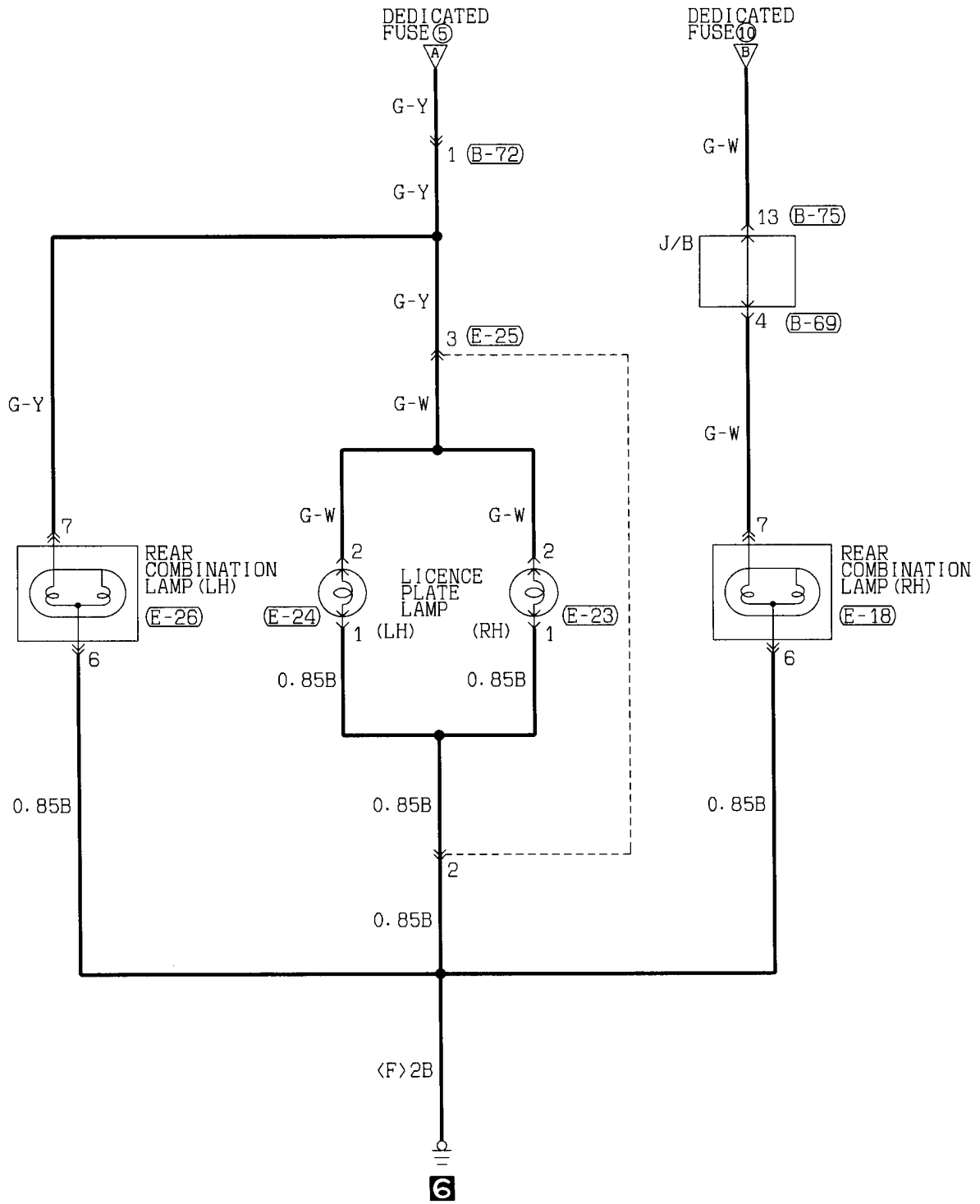

(B-75)

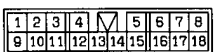

(B-76)

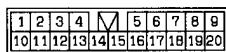

(E-18)

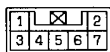

(E-23)



(E-24)



(E-25)



(E-26)

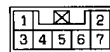

Wire colour code

B:Black LG:Light green G:Green L:Blue W:White SB:Sky blue
 BR:Brown O:Orange GR:Gray R:Red P:Pink V:Violet

TAIL LAMP, POSITION LAMP AND LICENCE PLATE LAMP (See P. 4-40.)**OPERATION**

1. **Vehicles without daytime running lamp.**
 - When the lighting switch is turned to the "TAIL" or "HEAD" position, current is supplied to cause each lamp to illuminate.
2. **Vehicles with daytime running lamp.**
 - Placing the lighting switch in the "TAIL" or "HEAD" position causes the tail lamp relay to be energized.
If the ignition switch is turned to the "ON" position, the tail lamp relay is always "ON".
 - As a result, current flows by way of dedicated fuse No. (5) and No. (10) to cause each lamp to go on.

TROUBLESHOOTING HINTS

1. No lamp goes on.
 - 1) Headlamps do not go on, either.
 - Check fusible link No. (5).
 - 2) Headlamps go on.
 - Check tail lamp relay.
 - Check dedicated fuse No. (5) and No. (10).

FRONT FOG LAMP (See P. 4-44.)**OPERATION**

- Placing the front fog lamp switch in the "ON" position energizes the front fog lamp relay. Then current flows by way of dedicated fuse No. (6) to cause the front fog lamp to go on. At this time, the illumination lamps goes on through the tail lamp relay.

TROUBLESHOOTING HINTS

1. The front fog lamp does not light up.
 - 1) The tail lamp lights up.
 - Check dedicated fuse No. (6).
 - Check front fog lamp relay.
 - Check front fog lamp switch.

FRONT FOG LAMP

90101190068

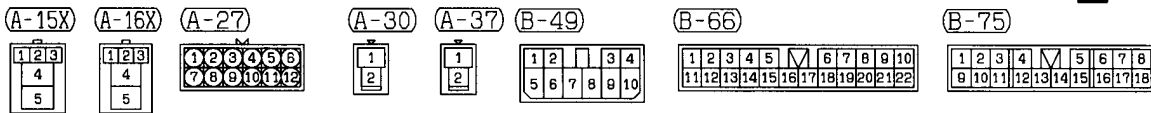
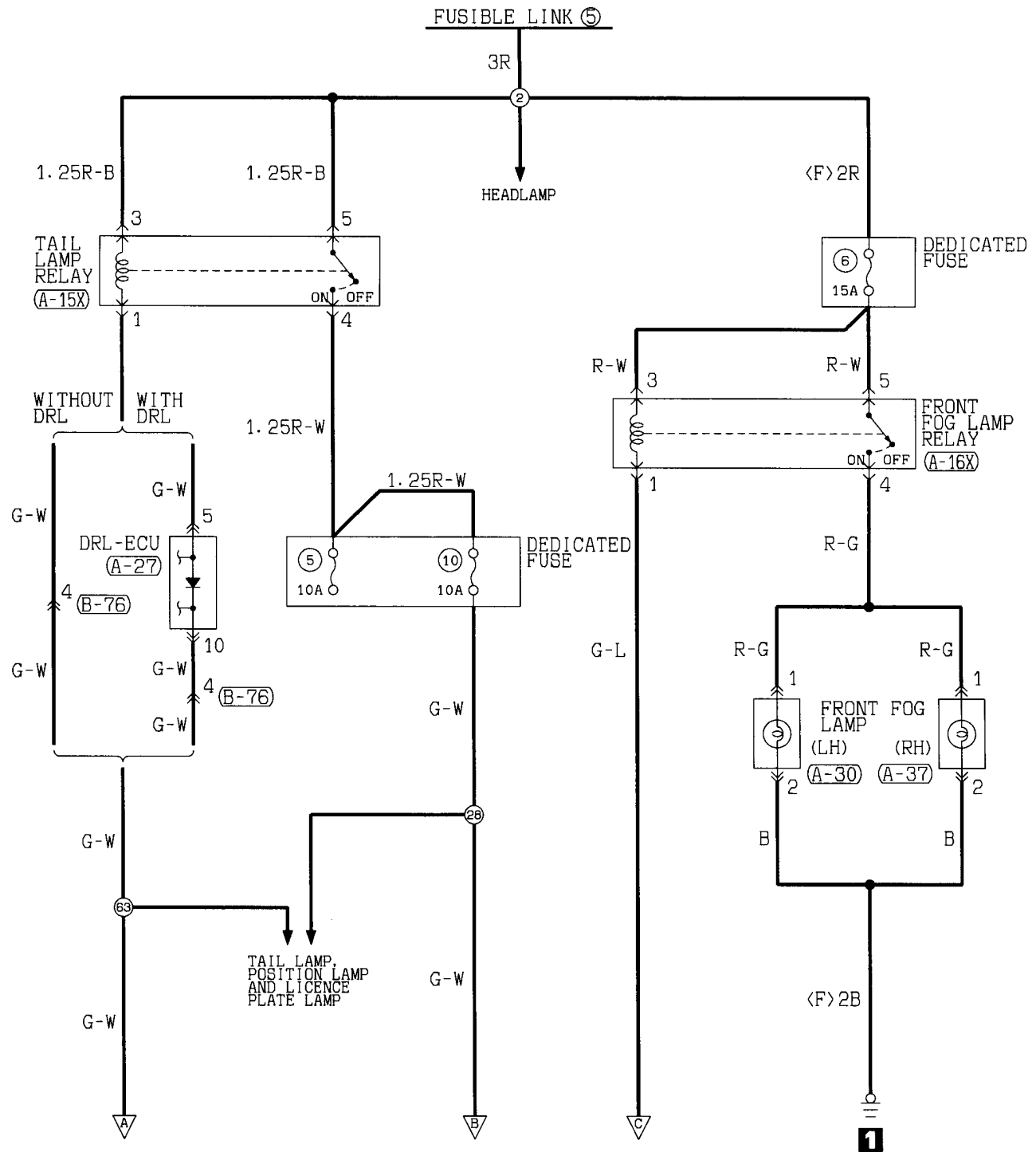

Wire colour code
 B:Black LG:Light green G:Green L:Blue W:White Y:Yellow SB:Sky blue
 BR:Brown O:Orange GR:Gray R:Red P:Pink V:Violet

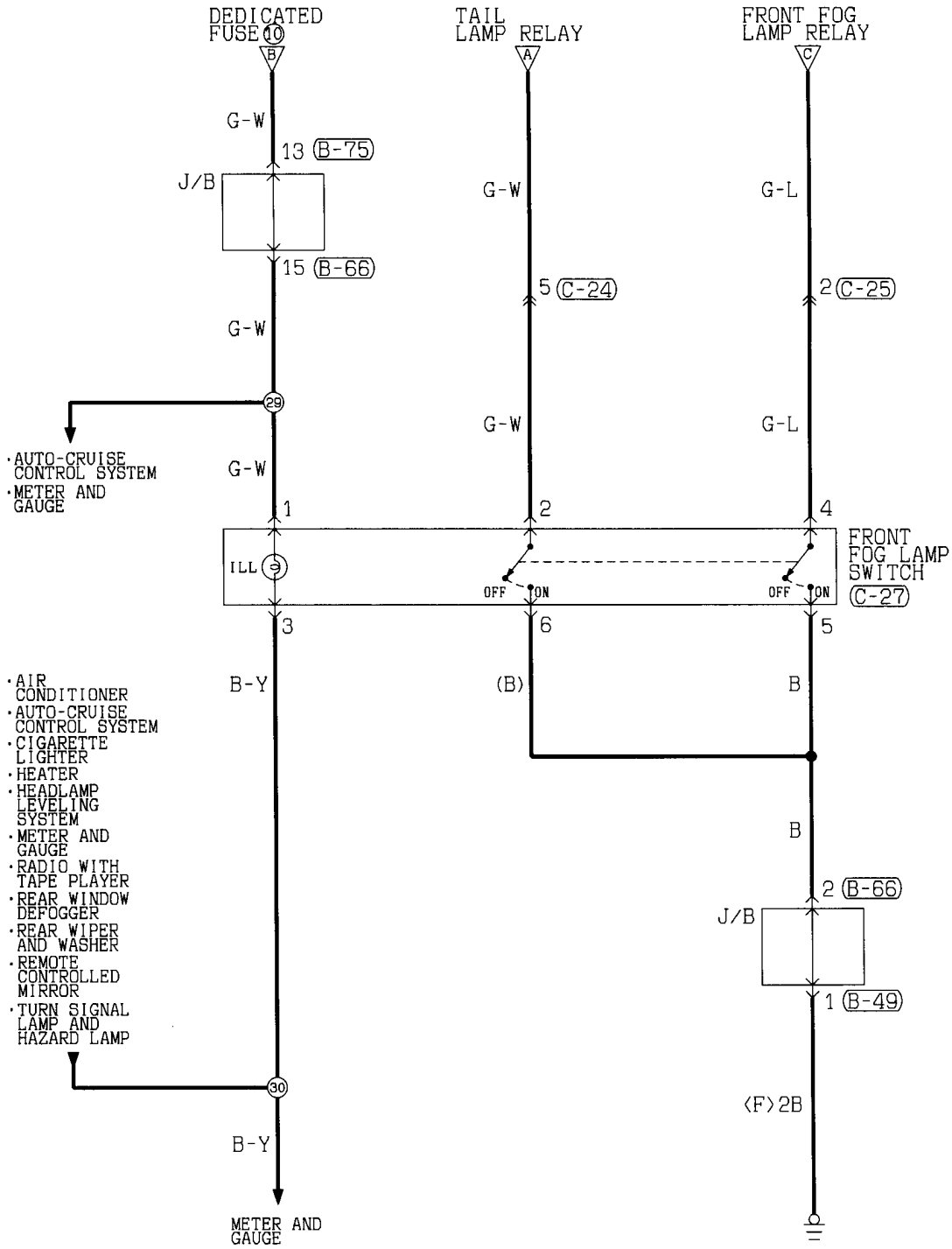

(B-76)

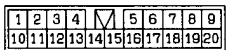

(C-24)

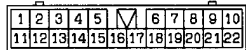

(C-25)

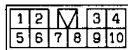

(C-27)



REAR FOG LAMP

9010120068

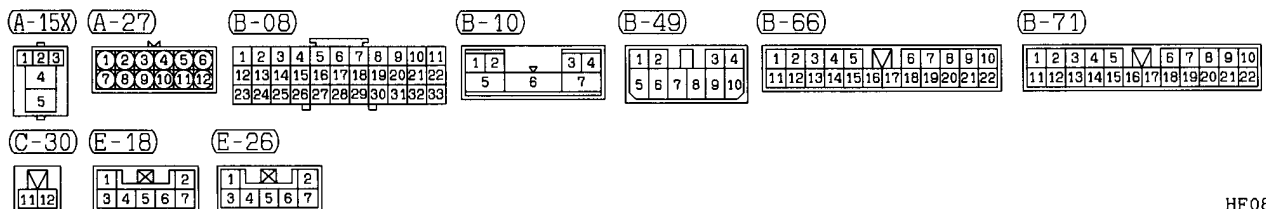
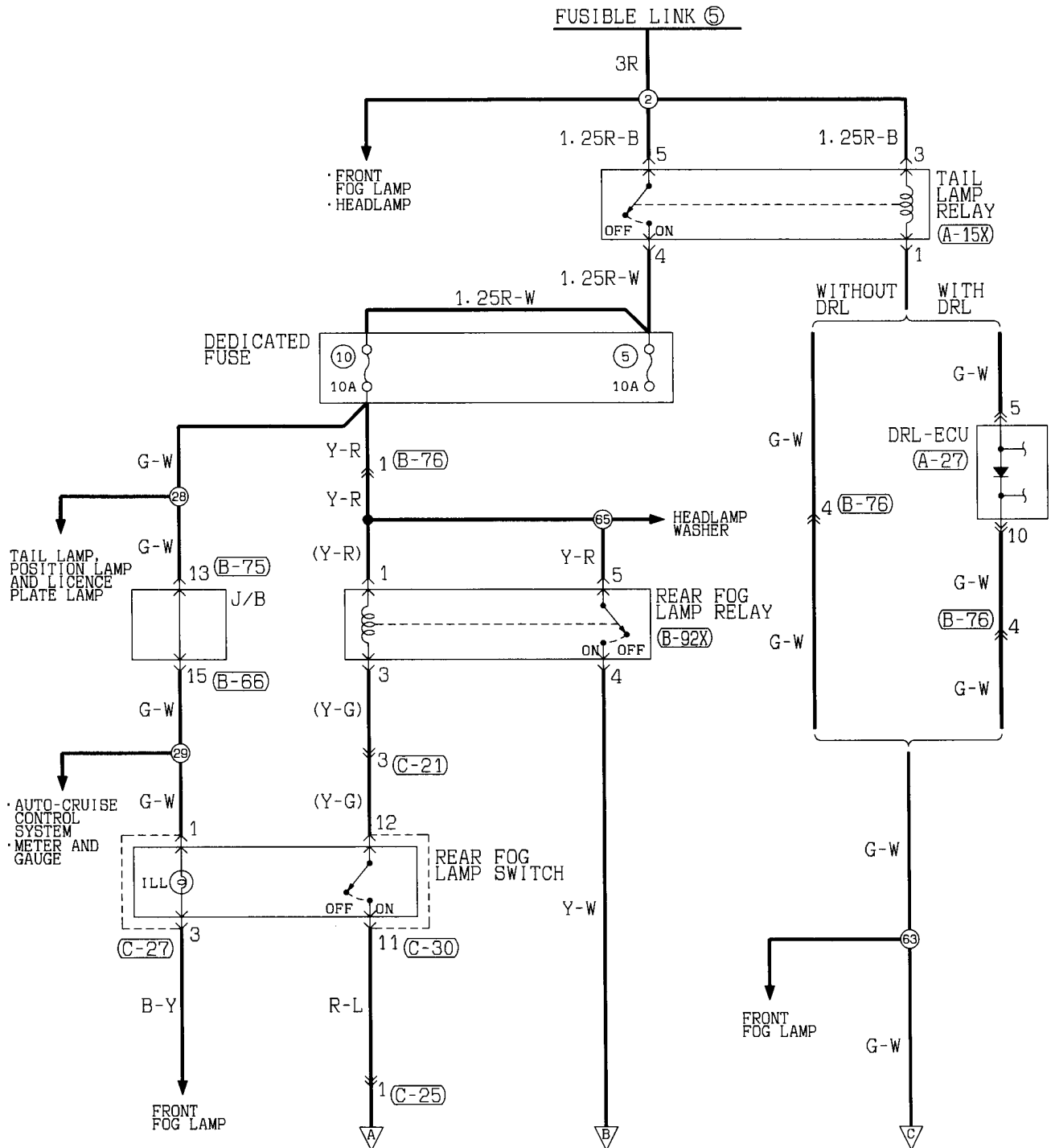

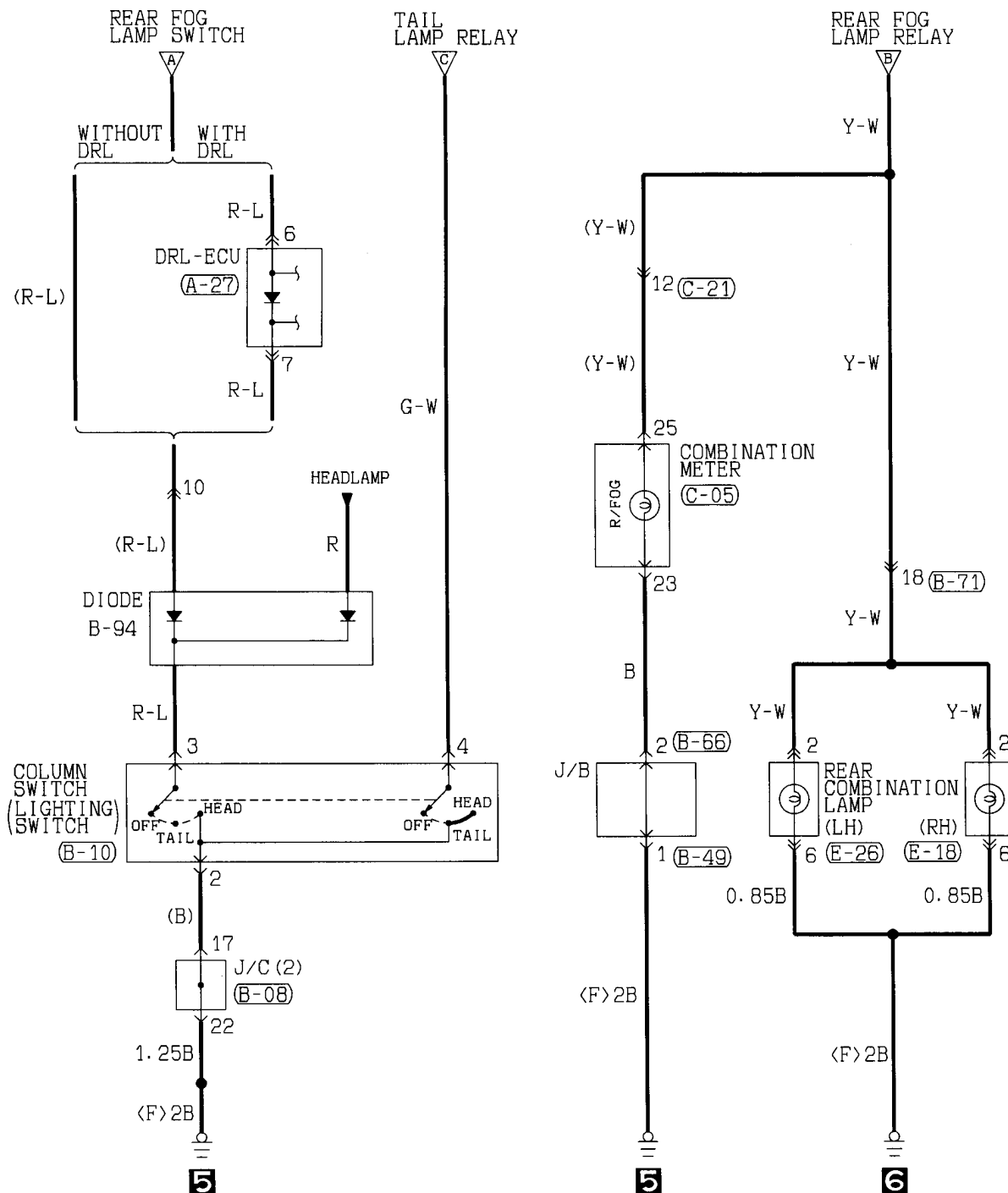

(B-75)

1	2	3	4	5	6	7	8		
9	10	11	12	13	14	15	16	17	18

(B-76)

1	2	3	4	M	5	6	7	8	9	
10	11	12	13	14	15	16	17	18	19	20

(B-92X)

1	2	3
4		
5		

(C-05)

2	1	22	23	24	25	26	27	28
29								
1	0	11	12	13	14	15	16	17

(C-21)

1	2	3	4	M	5	6	7	8	9	
10	11	12	13	14	15	16	17	18	19	20

(C-25)

1	2	M	3	4	
5	6	7	8	9	10

(C-27)

1	M	2	
3	4	5	6

Wire colour code

B:Black LG:Light green G:Green L:Blue W:White Y:Yellow SB:Sky blue
BR:Brown O:Orange GR:Gray R:Red P:Pink V:Violet

REAR FOG LAMP (See P. 4-46.)**OPERATION**

Rear Fog Lamp Relay ON Conditions

<Vehicles without daytime running lamp>

Refer to the table I.

<Vehicles with daytime running lamp>

Refer to the table II.

- Placing the lighting switch in the "HEAD" position energize the rear fog lamp relay. For vehicles with daytime running lamps, if the ignition switch is in the "ON" position, and the lighting switch is in the "OFF" position, the rear fog lamp relay will be energized.
- When the rear fog lamp switch is turned "ON" in this condition, the rear fog lamp goes on.

I

Ignition switch	Lighting switch	Rear fog lamp relay
—	"HEAD"	ON

II

Ignition switch	Lighting switch	Rear fog lamp relay
—	"HEAD"	ON
"ON"	"OFF" or "HEAD"	ON

TROUBLESHOOTING HINTS

1. The rear fog lamp doesn't illuminate.
 - 1) Headlamps go on.
 - Check the rear fog lamp relay.
 - Check the rear fog lamp switch.
 - Check the dedicated fuse No. (10).
 - 1) Headlamps do not go on, either.
 - Check the lighting switch.
 - Check the fusible link No. (5).
2. The rear fog lamp at the one side doesn't illuminate.
 - Check the lamp bulb.

GLOVE BOX LAMP

90100220034

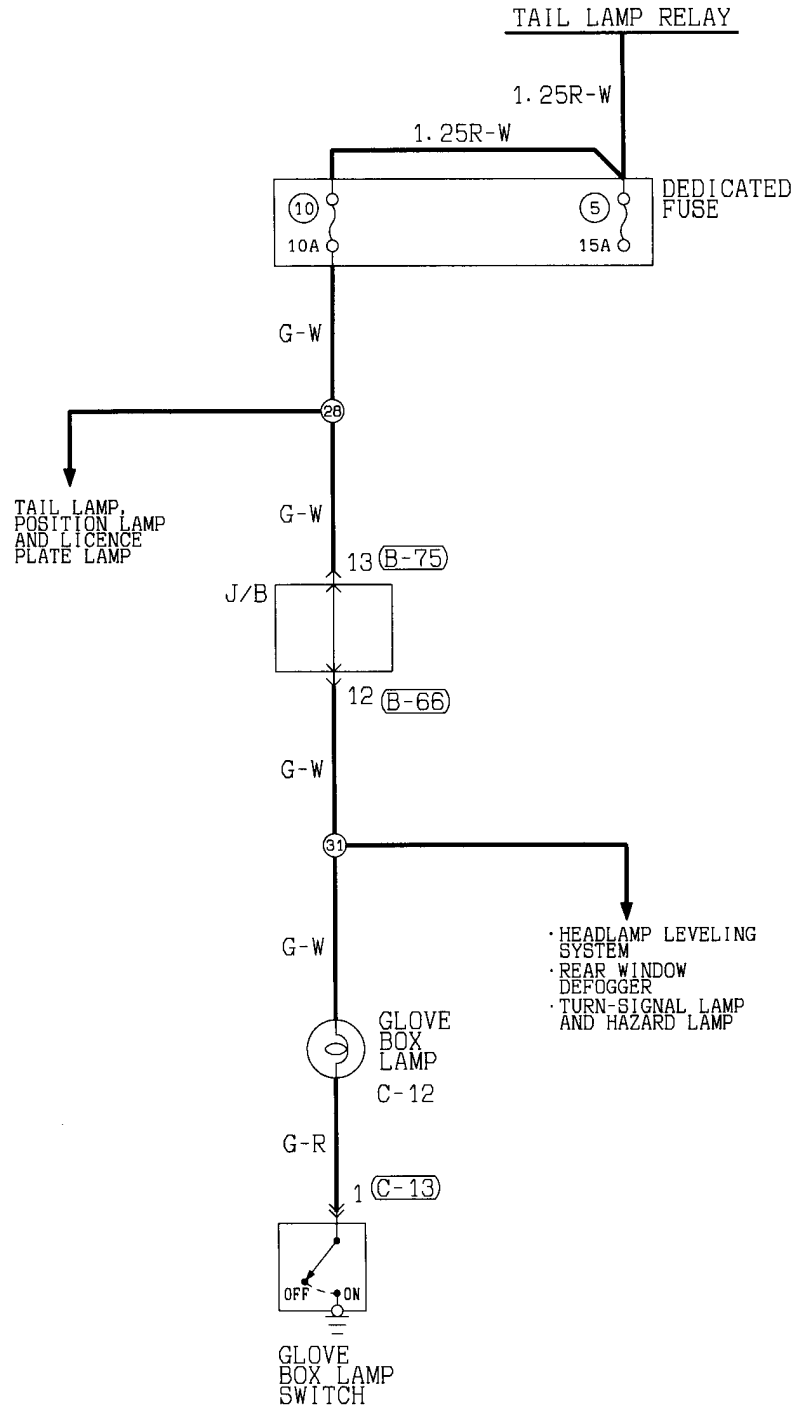

(B-66)

(B-75)

(C-13)

1	2	3	4	5	M	6	7	8	9	10	
11	12	13	14	15	16	17	18	19	20	21	22

1	2	3	4	M	5	6	7	8	
9	10	11	12	13	14	15	16	17	18

⏏

Wire colour code

B:Black LG:Light green G:Green L:Blue W:White Y:Yellow SB:Sky blue
BR:Brown O:Orange GR:Gray R:Red P:Pink V:Violet

ROOM LAMP, FOOT LAMP AND LUGGAGE COMPARTMENT LAMP

90101320023

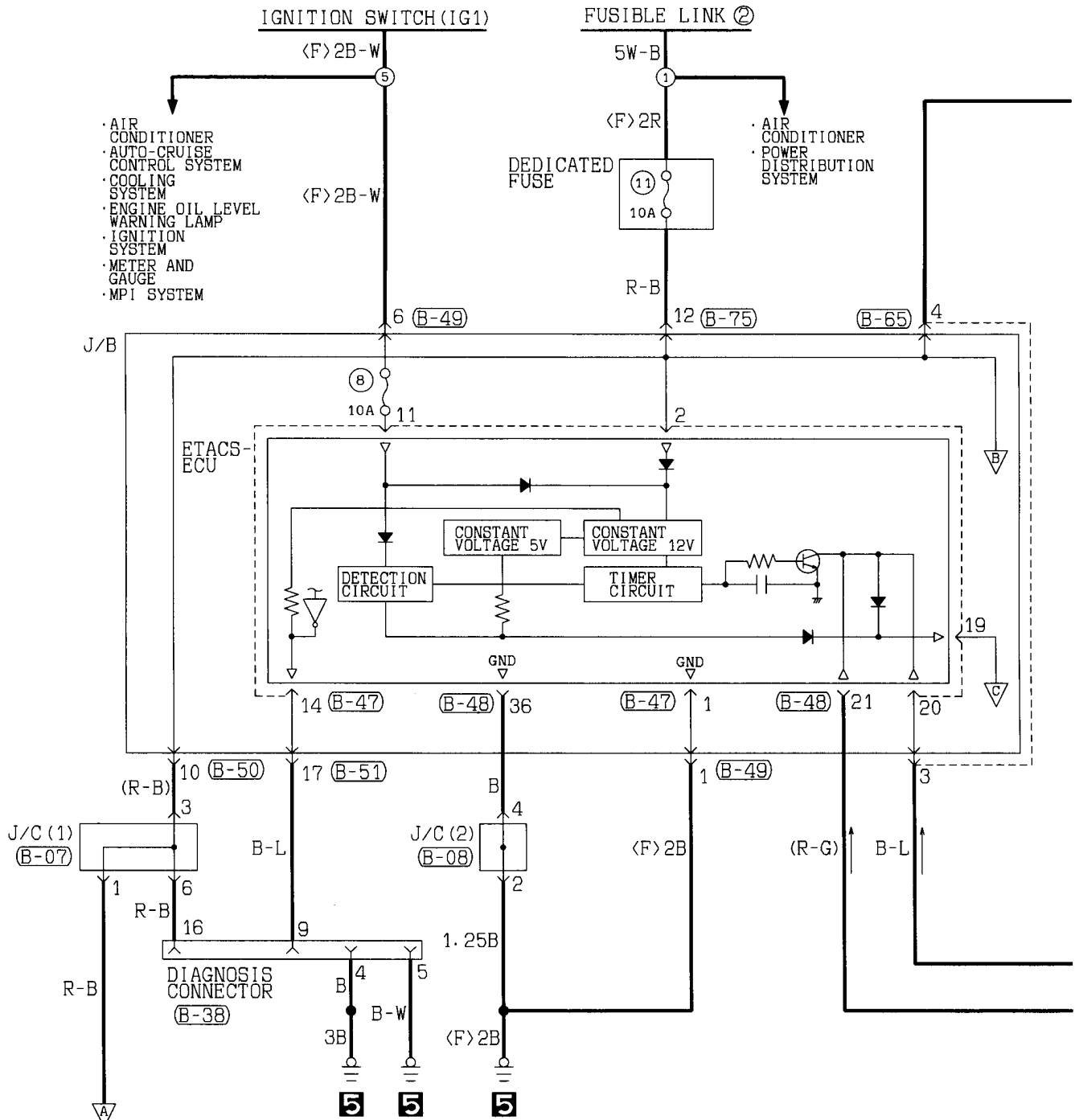

(B-07)

1	2	3	4	5	6	7	8	9	10	11
12	13	14	15	16	17	18	19	20	21	22
23	24	25	26	27	28	29	30	31	32	33

(B-08)

1	2	3	4	5	6	7	8	9	10	11
12	13	14	15	16	17	18	19	20	21	22
23	24	25	26	27	28	29	30	31	32	33

(B-38) FRONT SIDE

1	2	3	4	5	6	7	8
9	10	11	12	13	14	15	16

(B-47)

1	2	3	4	5	6	7	8	9	10	11	12	13	14	15	16	17	18	19	20
---	---	---	---	---	---	---	---	---	----	----	----	----	----	----	----	----	----	----	----

(B-48)

21	22	23	24	25	26	27	28
29	30	31	32	33	34	35	36

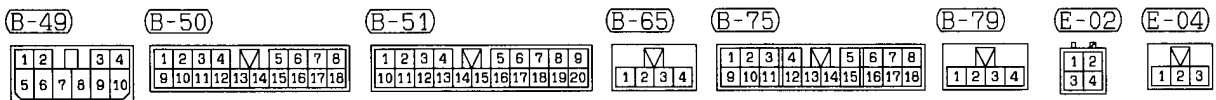
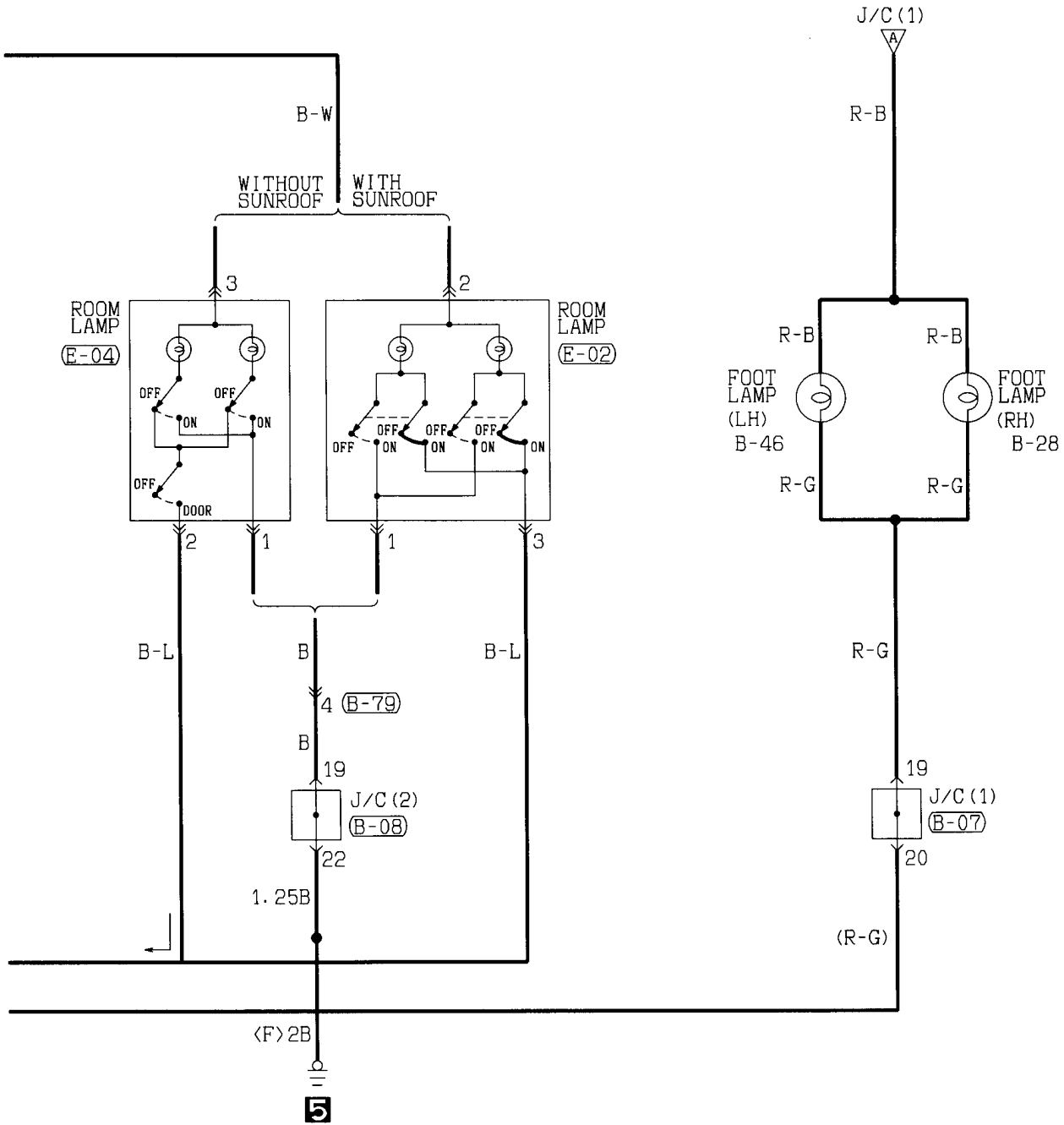

Wire colour code
 B:Black LG:Light green G:Green L:Blue W:White Y:Yellow SB:Sky blue
 BR:Brown O:Orange GR:Gray R:Red P:Pink V:Violet

DOOR LAMP, FOOT LAMP AND LUGGAGE COMPARTMENT LAMP (CONTINUED)

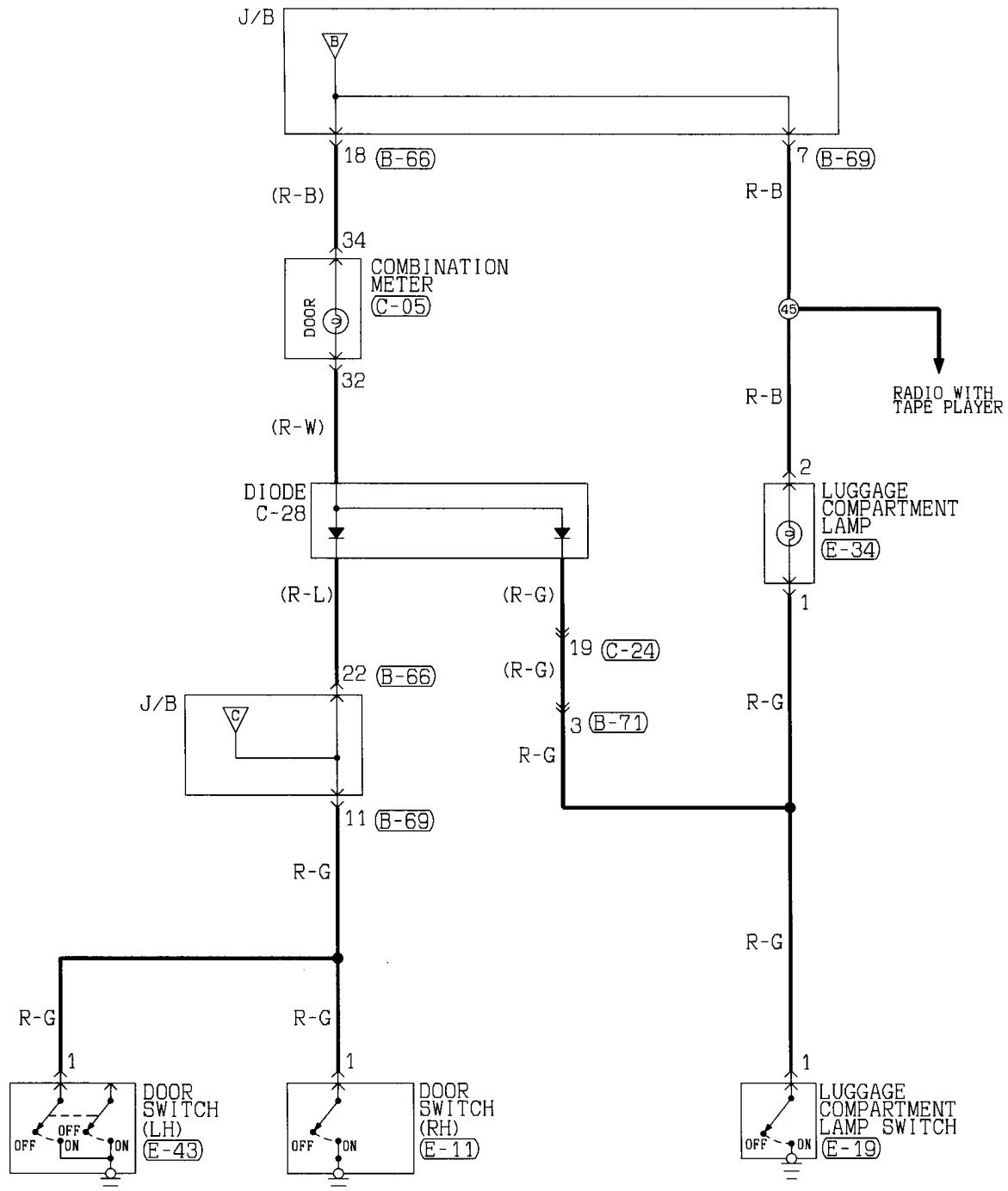

(B-66)

1	2	3	4	5	M	6	7	8	9	10	
11	12	13	14	15	16	17	18	19	20	21	22

(B-69)

1	2	3	4	M	5	6	7	8	9
10	11	12	13	14	15	16	17	18	19

(B-71)

1	2	3	4	5	M	6	7	8	9	10	
11	12	13	14	15	16	17	18	19	20	21	22

(C-05)

21	22	23	24	25	26	27	28
							29
30	31	32	33	34	35	36	37

(C-24)

1	2	3	4	5	M	6	7	8	9	10	
11	12	13	14	15	16	17	18	19	20	21	22

(E-11) (E-43) (E-19) (E-34)

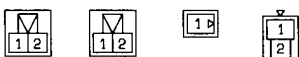

IGNITION KEY CYLINDER ILLUMINATION LAMP

90100260128

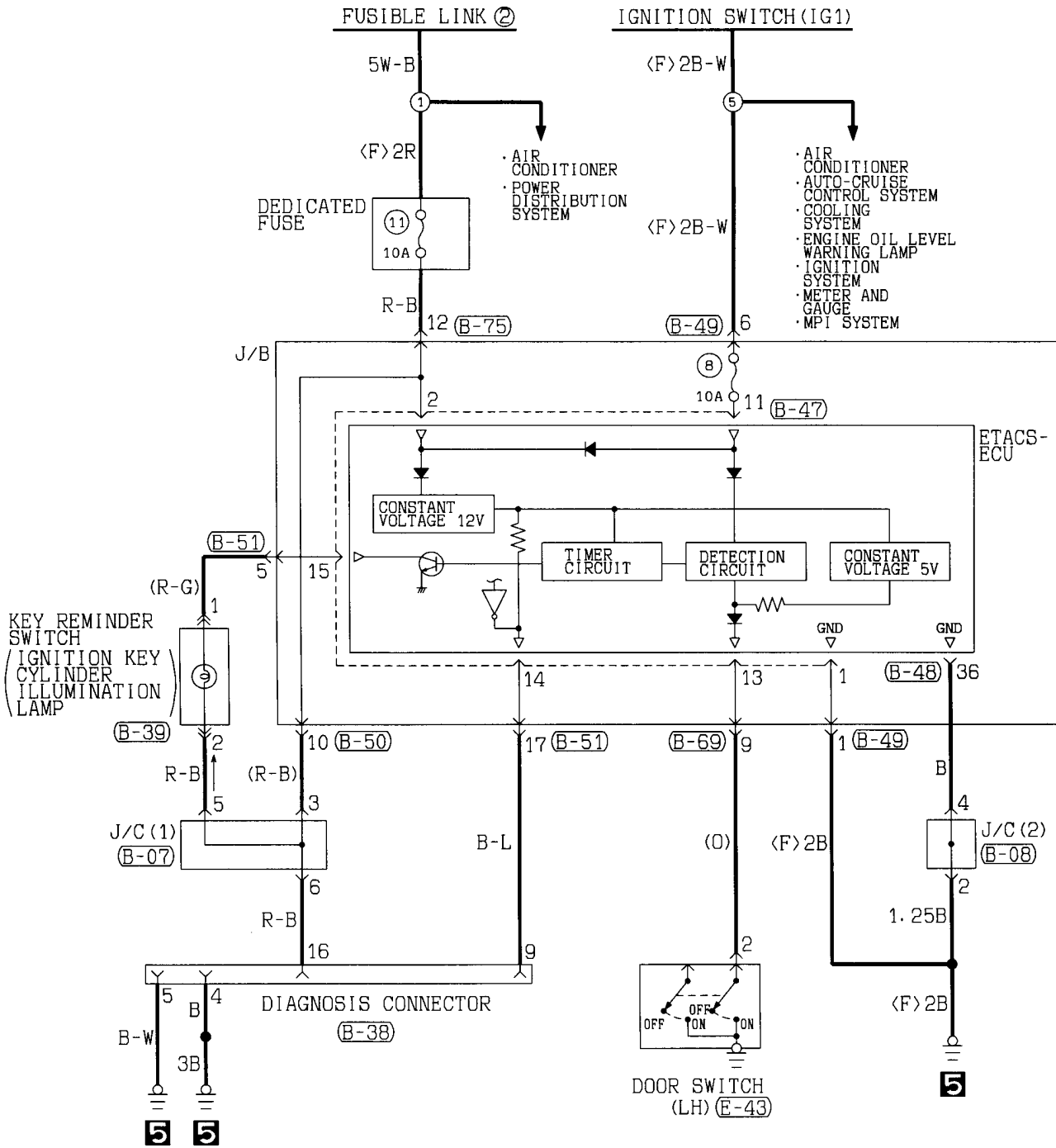

(B-07)

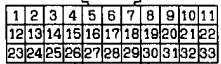

(B-08)

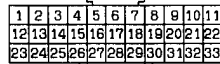

(B-38) FRONT SIDE

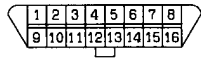

(B-39)

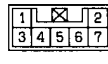

(B-47)

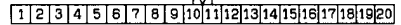

(B-48)

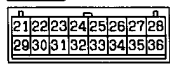

(B-49)

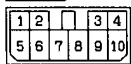

(B-50)

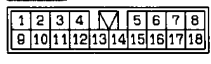

(B-51)

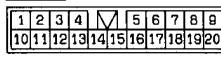

(B-69)

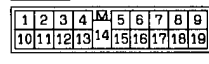

(B-75)

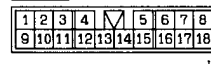

(E-43)



TURN-SIGNAL LAMP AND HAZARD LAMP

90100290103

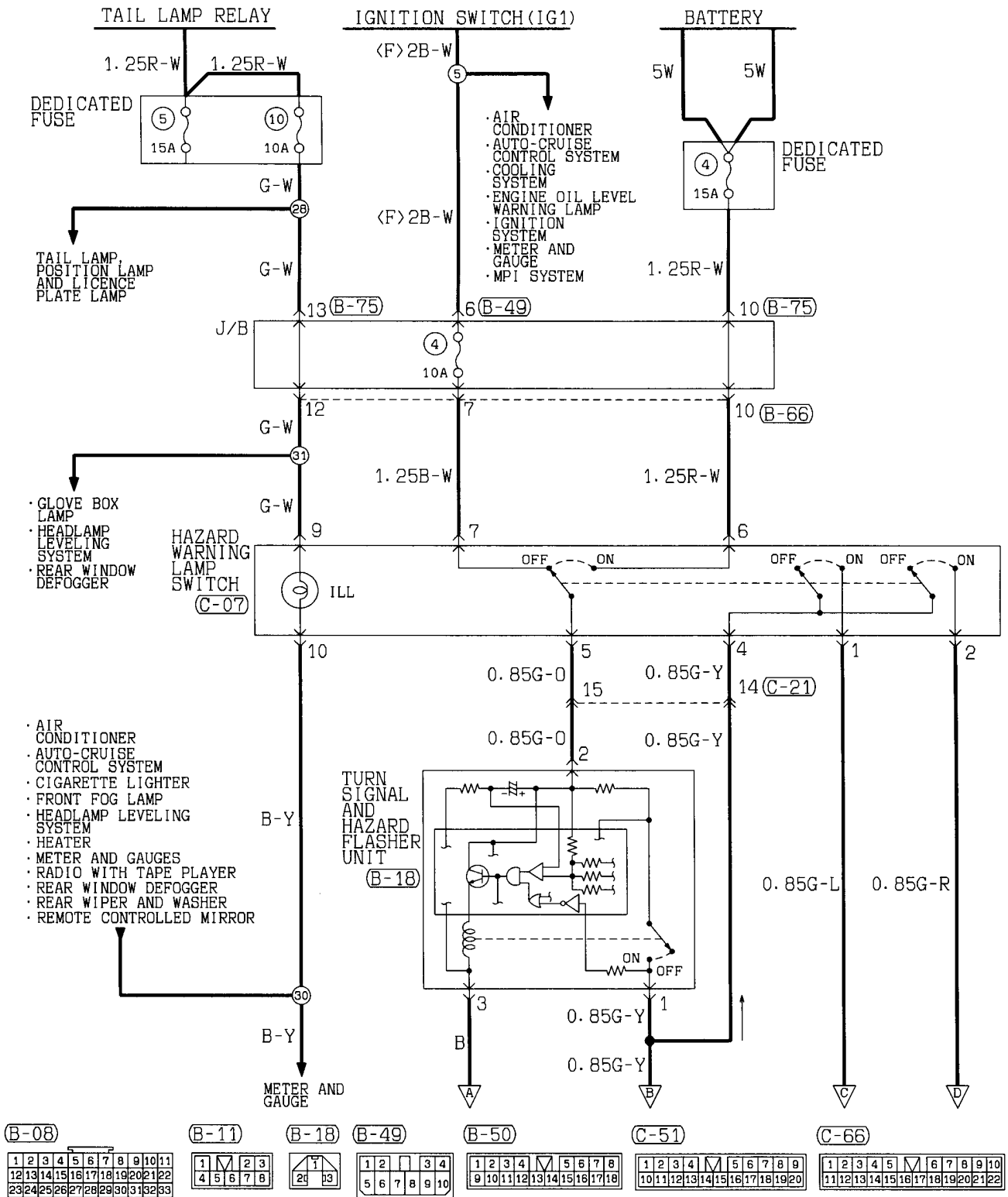

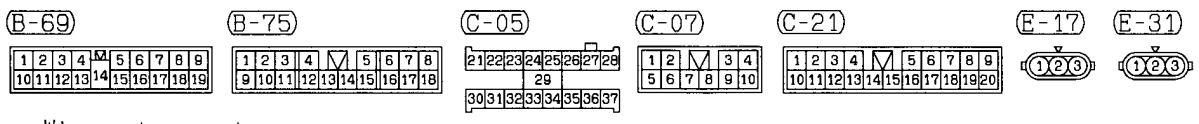
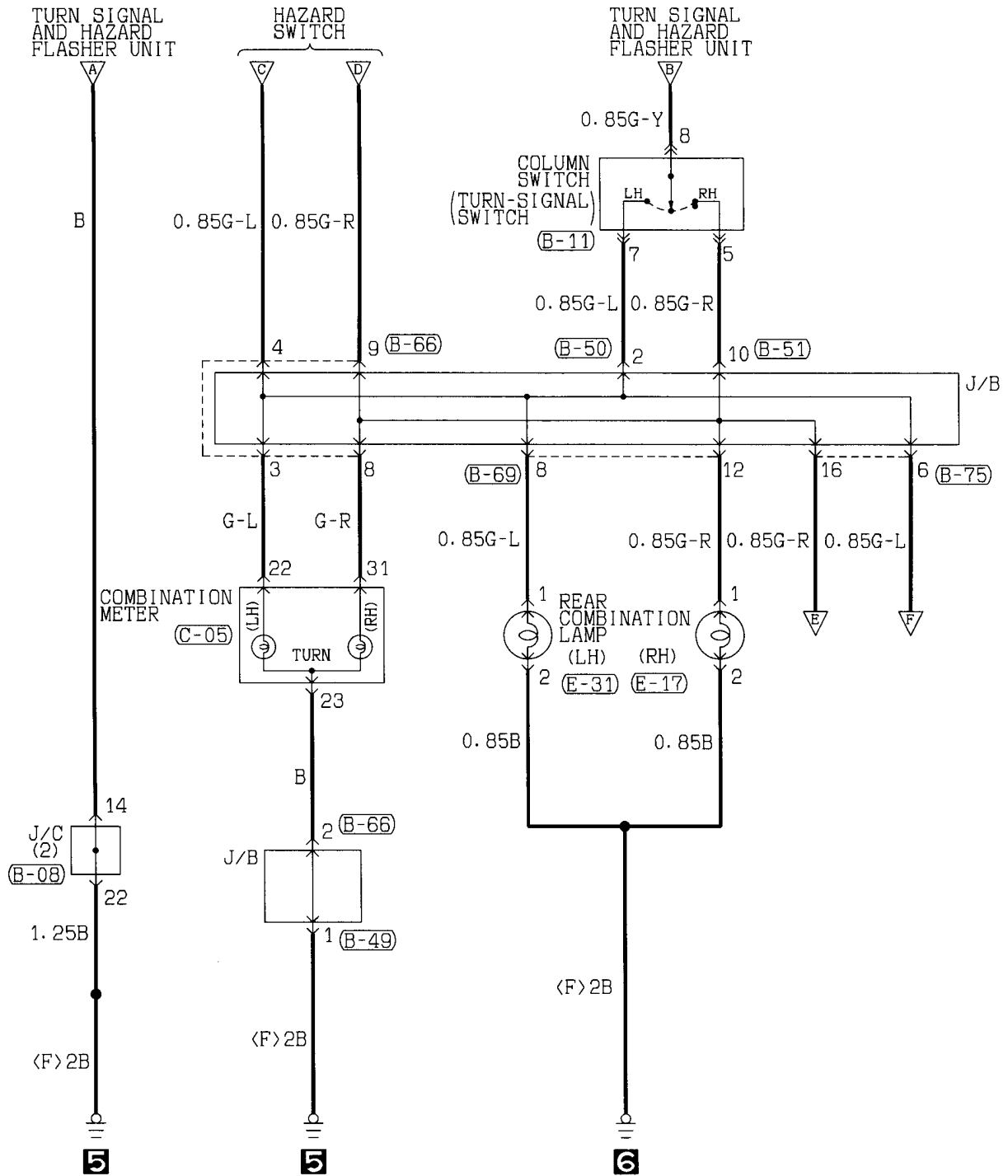

Wire colour code
 B:Black LG:Light green G:Green L:Blue W:White Y:Yellow SB:Sky blue
 BR:Brown O:Orange GR:Gray R:Red P:Pink V:Violet

TURN-SIGNAL LAMP AND HAZARD LAMP (CONTINUED)

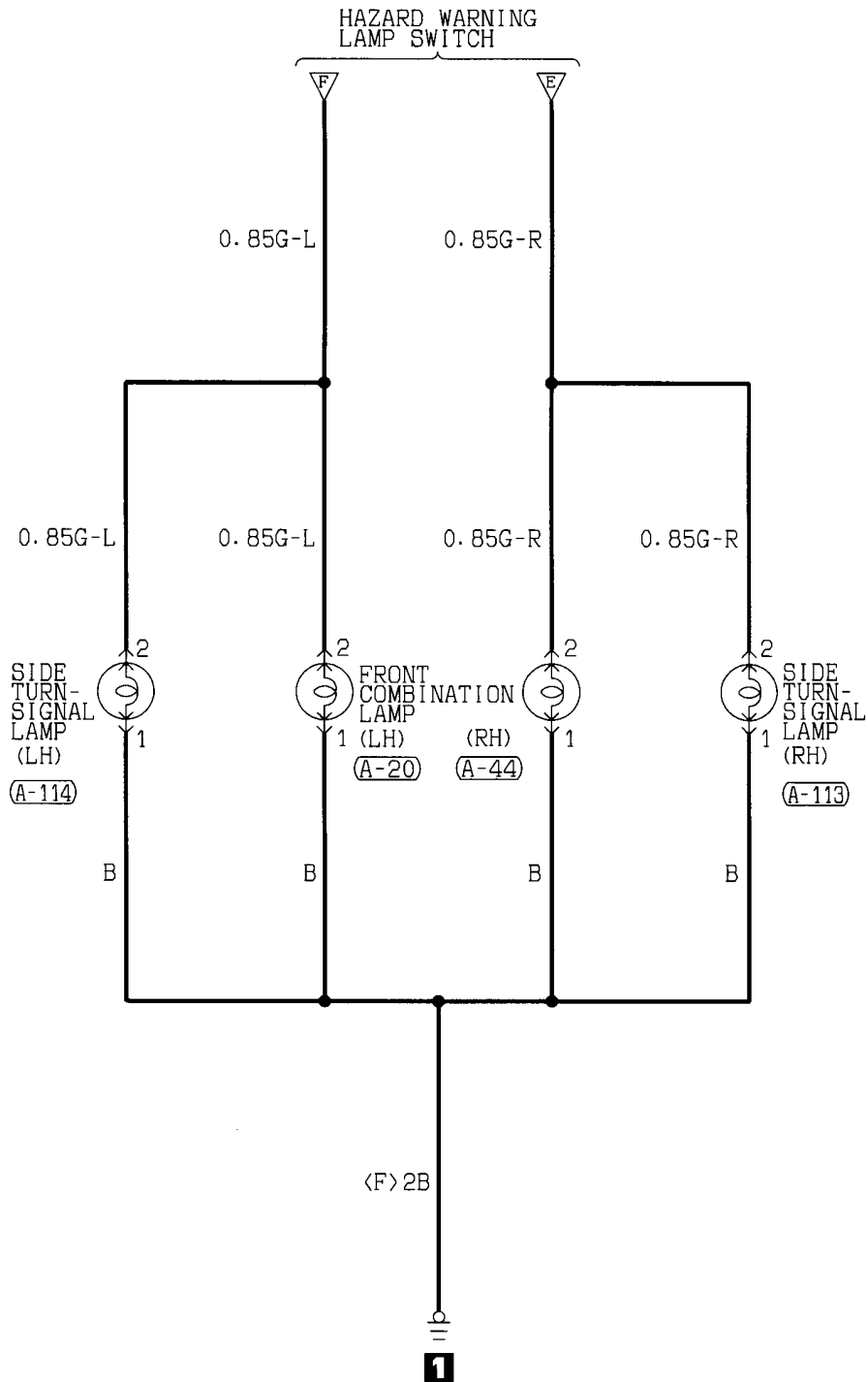

- (A-20)
- (A-44)
- (A-113)
- (A-114)
- (12)
- (12)
- (12)
- (12)

Wire colour code
 B:Black LG:Light green G:Green L:Blue W:White Y:Yellow SB:Sky blue
 BR:Brown O:Orange GR:Gray R:Red P:Pink V:Violet

TURN-SIGNAL LAMP AND HAZARD LAMP (See P. 4-54.)**OPERATION****<Turn-signal lamp>****1. In standard operating condition**

- When the ignition switch is placed in the ON position, battery voltage is applied through the hazard warning switch to the turn-signal and hazard warning flasher unit.
- When the turn signal switch is turned to the "LH" or "RH" position, the relay contact turns "ON" and "OFF" repeatedly due to the switching operation of the capacitor and transistor inside the flasher unit, and the turn signal lamp and the "LH" and "RH" of the turn signal indicator lamp flash.

2. When one bulb is burnt

- When either one of the turn signal lamp is burnt, the resistance of the entire lamp circuit increases, so that the time required for charging and discharging of the capacitor is shortened, causing the "ON" "OFF" cycle of the relay to become faster than standard and the number of flashes to increase.

<Hazard lamp>

- When the hazard warning switch is turned to the "ON" position, current flows via dedicated fuse No. (4) to the flasher unit, the flasher unit relay contacts repeatedly close and open, which results in the RH and LH turn-signal lamps, turn-signal indicator lamps, and hazard indicator lamps flashing on and off at the same time.

Remark

- The number of times the hazard lamps flash on and off does not change even when one bulb is out.

TROUBLESHOOTING HINTS

1. Neither the turn-signal lamp nor hazard lamps operate.
 - Check hazard warning switch contacts (on power source end).
 - Check flasher unit.
2. All LH or RH turn-signal lamps do not operate.
 - (1) Hazard lamp is fully operational.
 - Check turn-signal switch.
3. Flashing cycle of turn signal lamps is shorter.
 - Check the lamp bulb.
 - Check flasher unit.
4. Hazard lamp does not operate.
 - (1) Turn-signal lamps are operational.
 - Check dedicated fuse No. (4).
 - Check hazard warning switch contacts (on hazard lamp end).

STOP LAMP

90100300110

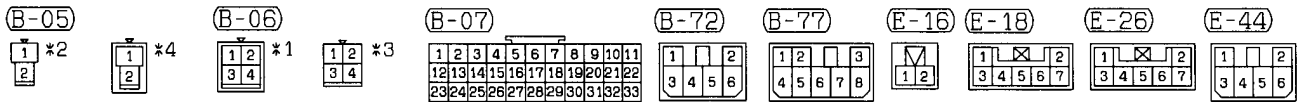
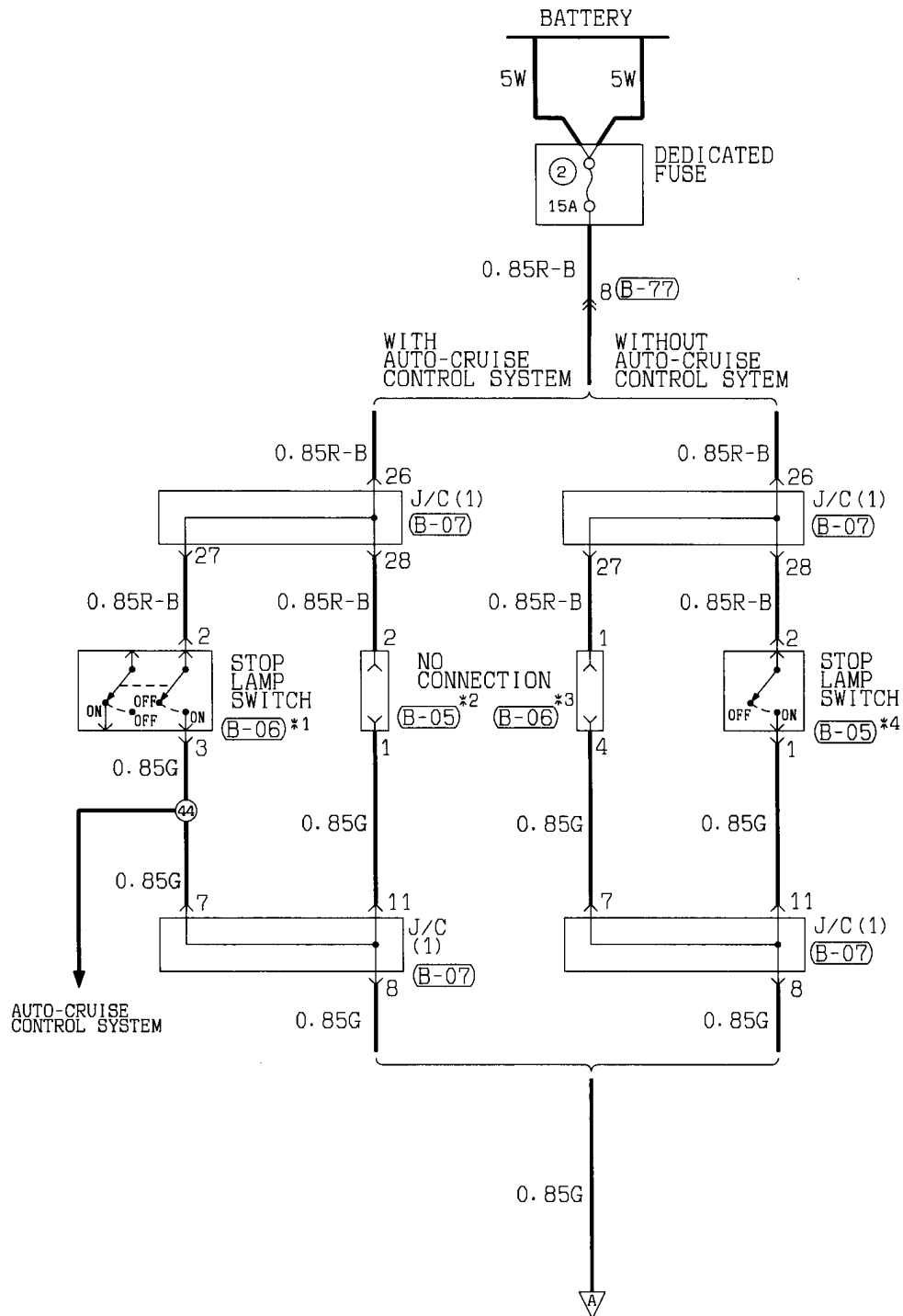

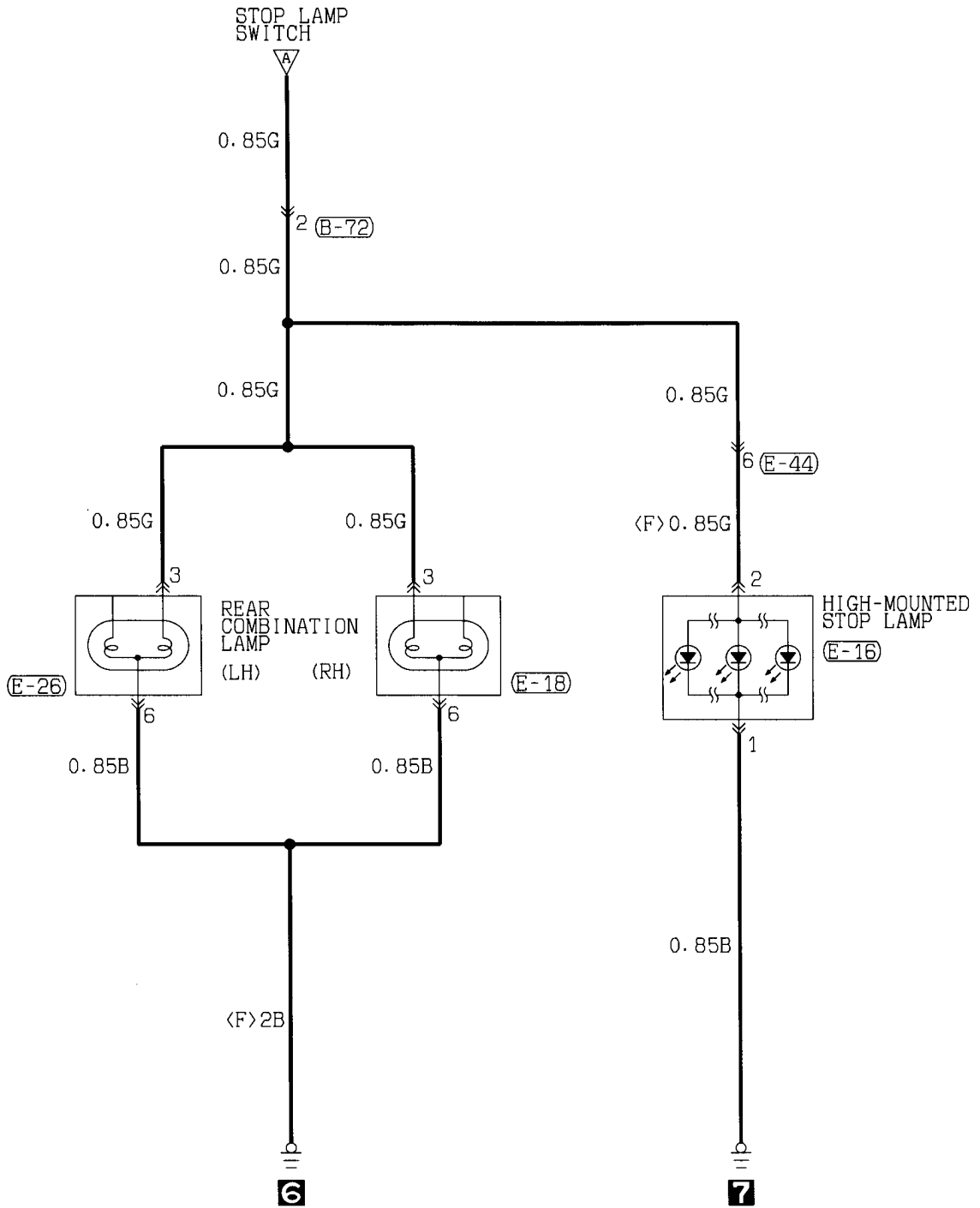

Wire colour code
 B:Black LG:Light green G:Green L:Blue W:White Y:Yellow SB:Sky blue
 BR:Brown O:Orange GR:Gray R:Red P:Pink V:Violet

BACK-UP LAMP

90100310144

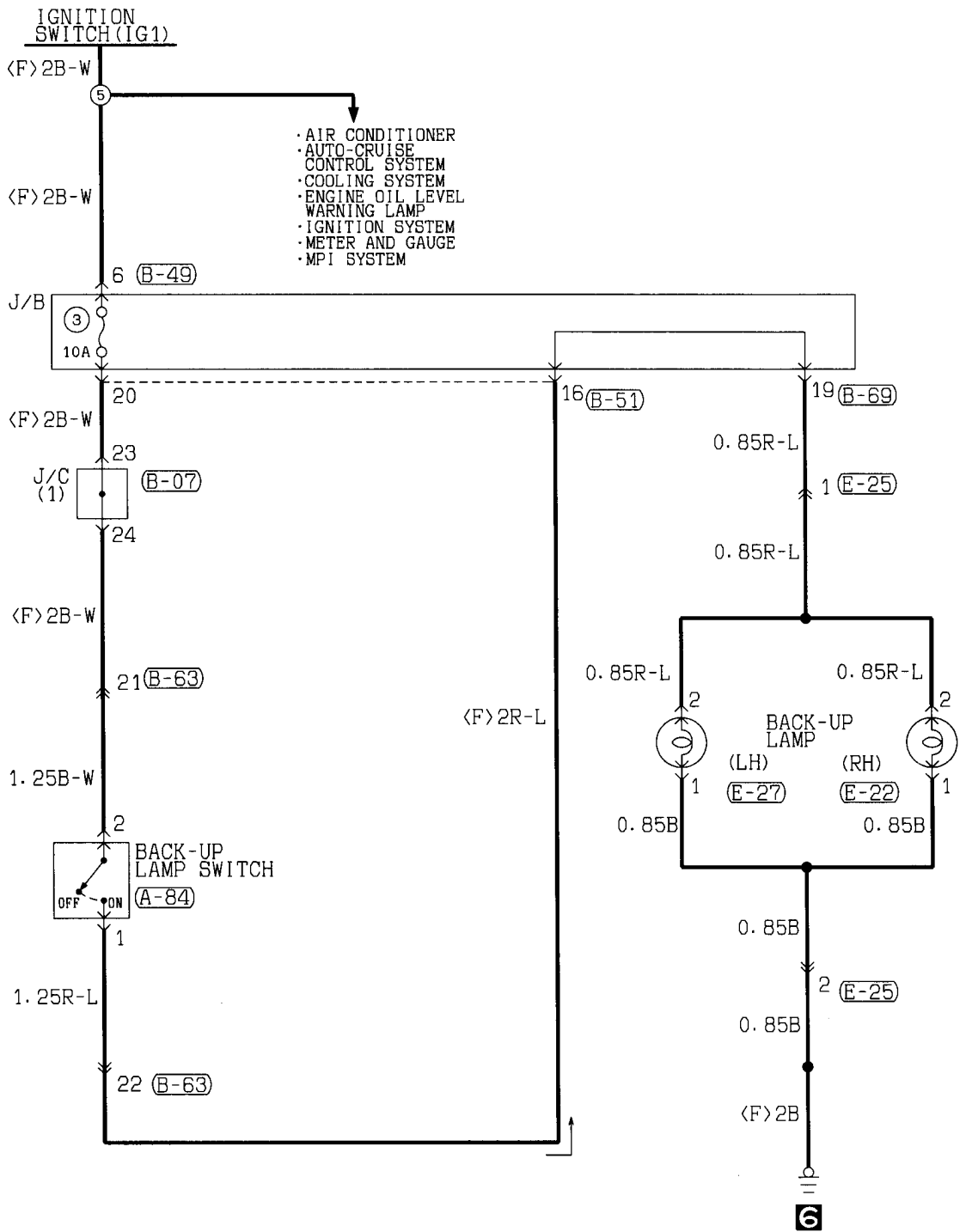

(A-84)

(B-07)

(B-49)

(B-51)

(B-63)

(B-69)

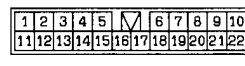
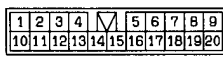
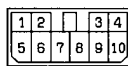

(E-22)

(E-25)

(E-27)



HORN

90100330119

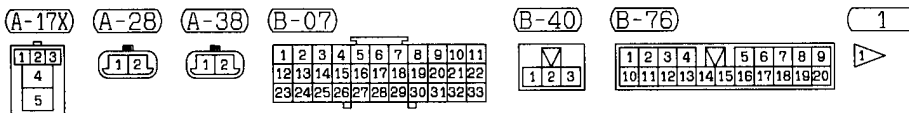
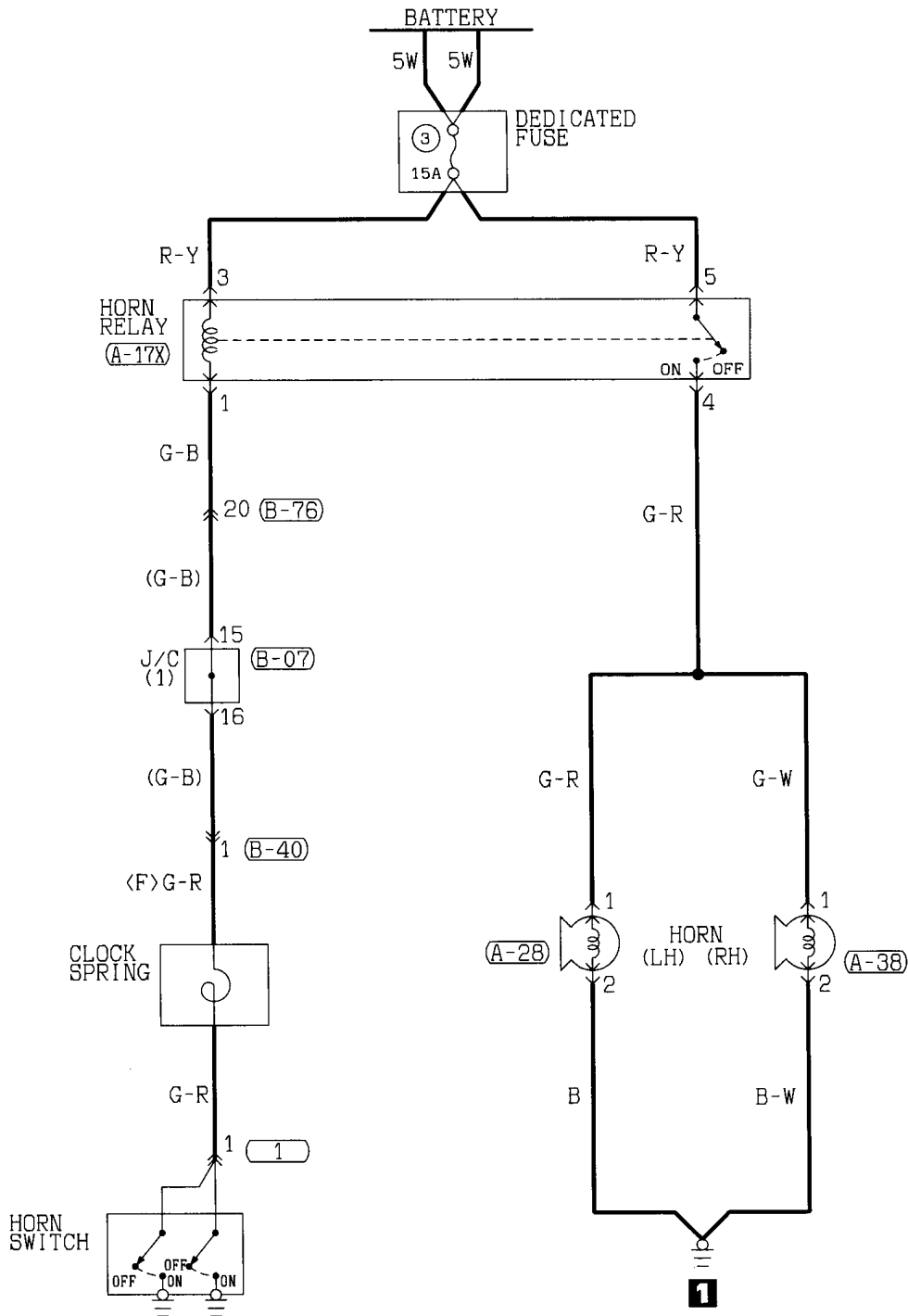

Wire colour code
 B:Black LG:Light green G:Green L:Blue W:White Y:Yellow SB:Sky blue
 BR:Brown O:Orange GR:Gray R:Red P:Pink V:Violet

METER AND GAUGES

90100350160

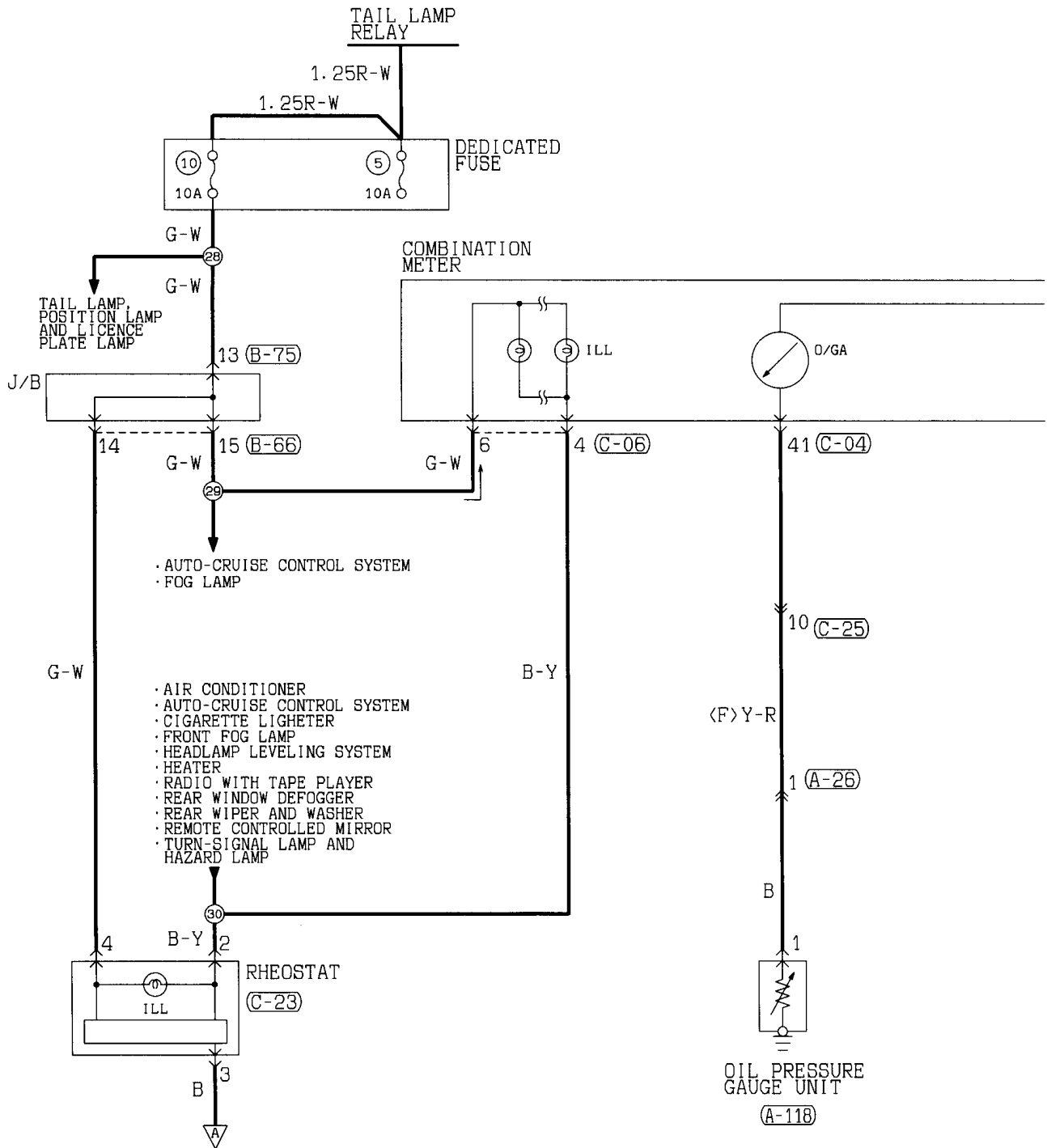

(A-26)

(A-96)

(A-118)

(B-49)

(B-66)

(B-71)

(B-75)

1

1

1

1	2	3	4
5	6	7	8
9	10		

1	2	3	4	5	6	7	8	9	10
11	12	13	14	15	16	17	18	19	20
21	22								

1	2	3	4	5	6	7	8	9	10
11	12	13	14	15	16	17	18	19	20
21	22								

1	2	3	4	5	6	7	8
9	10	11	12	13	14	15	16
17	18						

(C-04)

41	42	43	44	45	46	47	48
				49			
50	51	52	53	54	55	56	57

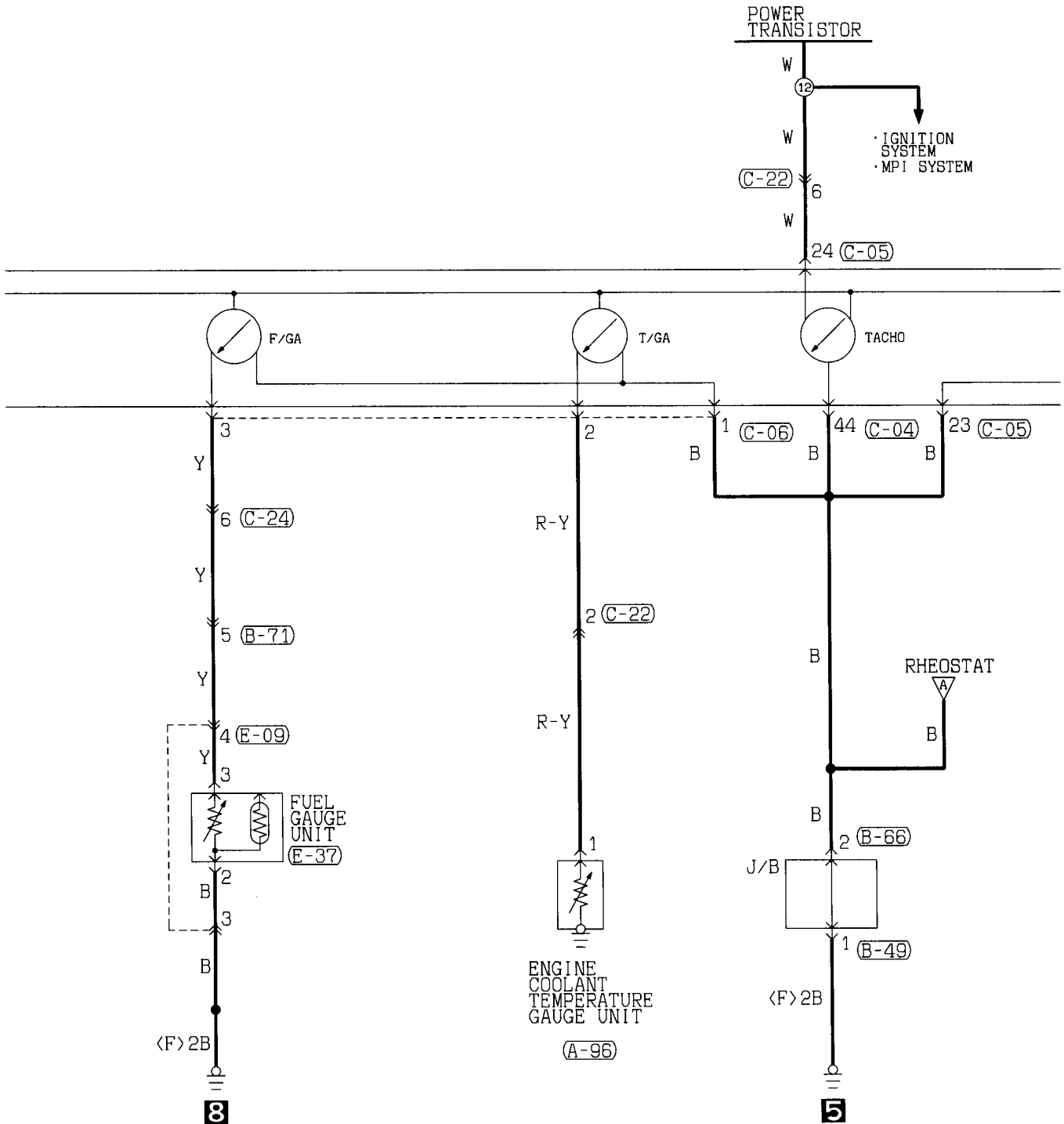

(C-05)	(C-06)	(C-22)	(C-23)	(C-24)	(C-25)	(E-09)	(E-37)
21 22 23 24 25 26 27 28 29	1 2 3 4 5 6 7 8 9	1 2 3 4 5 6 7 8 9 10 11 12 13 14 15 16 17 18	1 2 3 4	1 2 3 4 5 6 7 8 9 10 11 12 13 14 15 16 17 18 19 20 21 22	1 2 3 4 5 6 7 8	1 2 3 4 5 6 7 8	1 2 3

Wire colour code
 B:Black LG:Light green G:Green L:Blue W:White Y:Yellow SB:Sky blue
 BR:Brown O:Orange GR:Gray R:Red P:Pink V:Violet

METER AND GAUGES (CONTINUED)

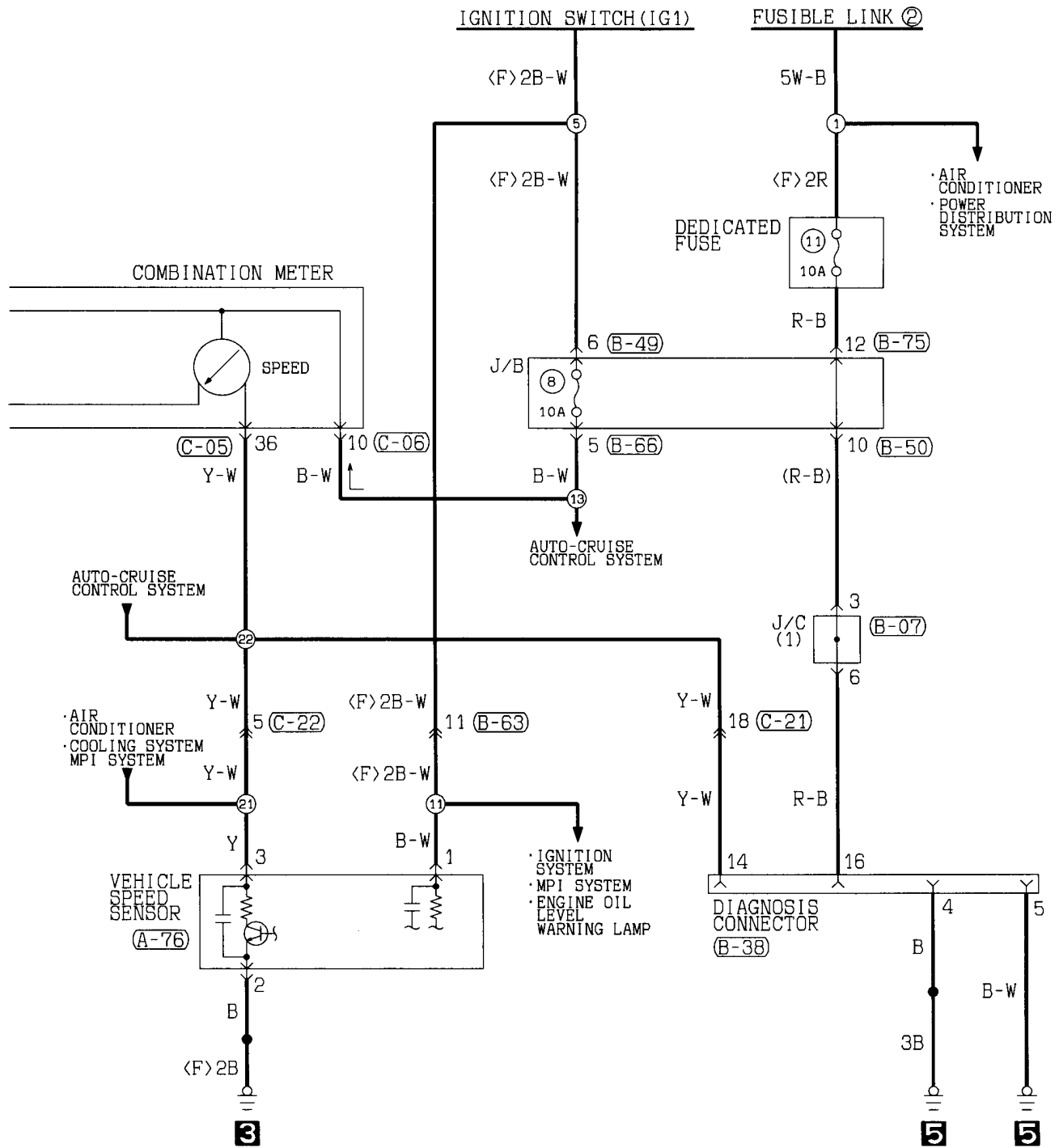

(A-76)

1	2	3
---	---	---

(B-07)

1	2	3	4	5	6	7	8	9	10	11
12	13	14	15	16	17	18	19	20	21	22
23	24	25	26	27	28	29	30	31	32	33

(B-38) FRONT SIDE

1	2	3	4	5	6	7	8
9	10	11	12	13	14	15	16

(B-49)

1	2	3	4
5	6	7	8
9	10		

(B-50)

1	2	3	4	M	5	6	7	8	
9	10	11	12	13	14	15	16	17	18

(B-63)

1	2	3	4	5	M	6	7	8	9	10	
11	12	13	14	15	16	17	18	19	20	21	22

(B-66)

1	2	3	4	5	M	6	7	8	9	10	
11	12	13	14	15	16	17	18	19	20	21	22

(B-75)

1	2	3	4	M	5	6	7	8	
9	10	11	12	13	14	15	16	17	18

(C-05)

21	22	23	24	25	26	27	28
29							
30	31	32	33	34	35	36	37

(C-06)

1	2	3	4	5	6	7	8
9							
10	11	12	13	14	15	16	17

(C-21)

1	2	3	4	M	5	6	7	8	9	
10	11	12	13	14	15	16	17	18	19	20

(C-22)

1	2	3	4	M	5	6	7	8	
9	10	11	12	13	14	15	16	17	18

METER AND GAUGES (See P. 4-62.)**OPERATION****<Fuel gauge>**

- When the ignition switch is at the "ON" position, the fuel gauge is activated.
- When there is much fuel, the unit's resistance is small and the current flowing in the circuit is great, so the gauge's indicator indicates in the "Full" area.
- When there is little fuel, the unit's resistance is high and the current flowing in the circuit is small, so the gauge's indicator indicates in the "Empty" area.

<Engine coolant temperature gauge>

- When the ignition switch is at the "ON" position, the engine coolant temperature gauge is activated.
- When the engine coolant temperature is high, the unit's resistance is low and there is a great flow of current in the circuit, so the gauge's indicator indicates in the "H" area.
- When the engine coolant temperature is low, the unit's resistance is high and there is a small flow of current in the circuit, so the gauge's indicator indicates in the "C" area.

TROUBLESHOOTING HINTS

1. Fuel gauge does not operate, or registers incorrectly.
 - (1) The fuel gauge indicates "F" when the fuel gauge unit connector is disconnected and the "3" terminal is earthed.
 - Check fuel gauge.
2. Engine coolant temperature gauge does not operate, or registers incorrectly.
 - (1) When the engine coolant temperature gauge is earthed with its connector unplugged, it registers "H".
 - Check engine coolant temperature gauge unit.
3. Meter illumination lamp does not illuminate.
 - (1) Tail lamps illuminate.
 - Check rheostat.

BRAKE WARNING LAMP

90101180085

OIL PRESSURE WARNING LAMP

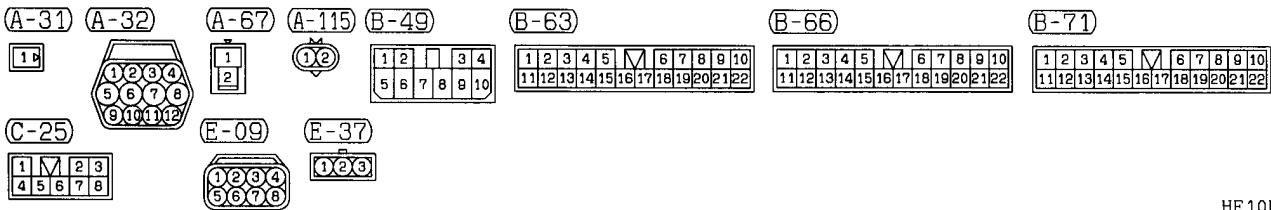
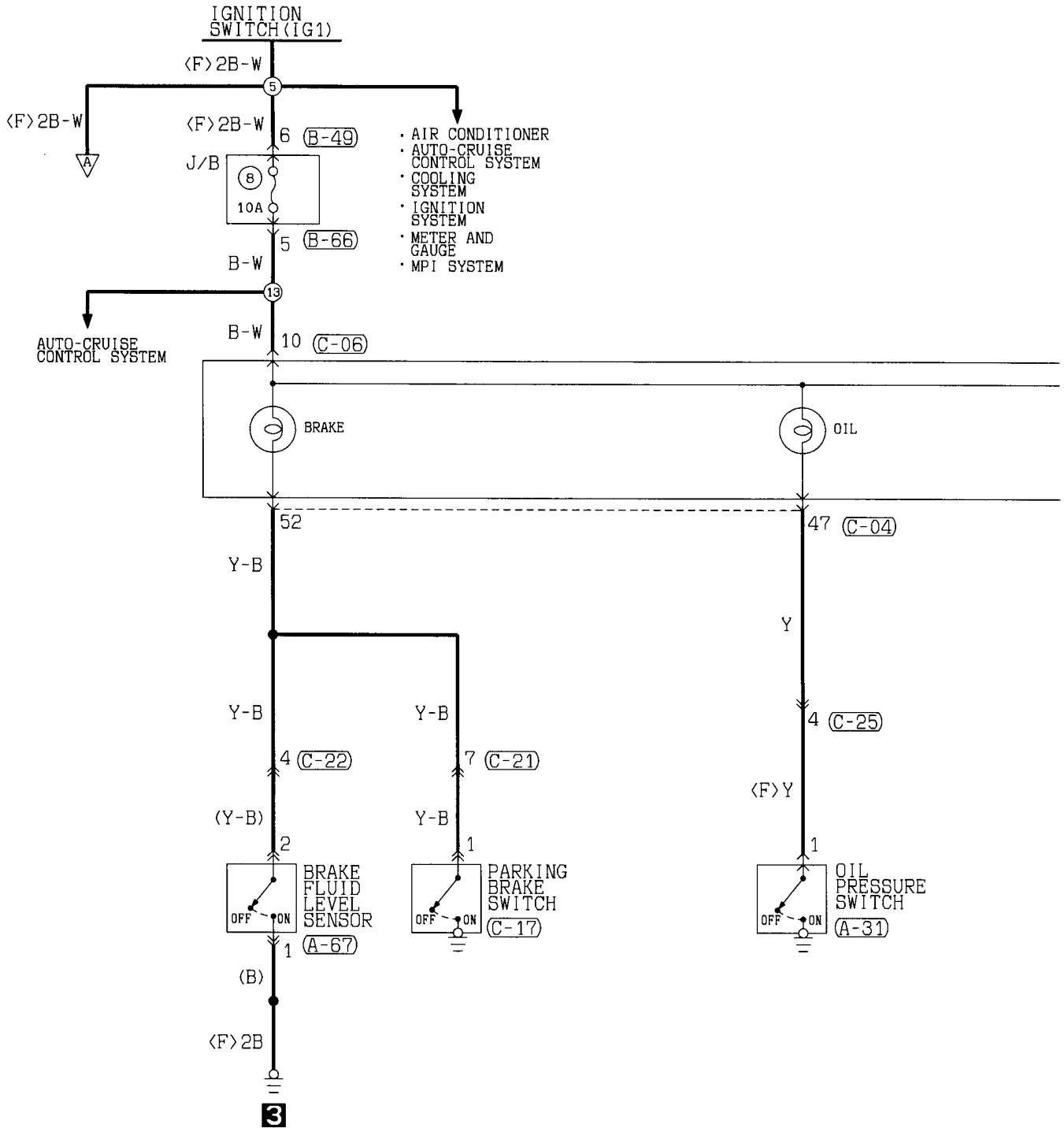

FUEL WARNING LAMP
ENGINE OIL LEVEL WARNING LAMP

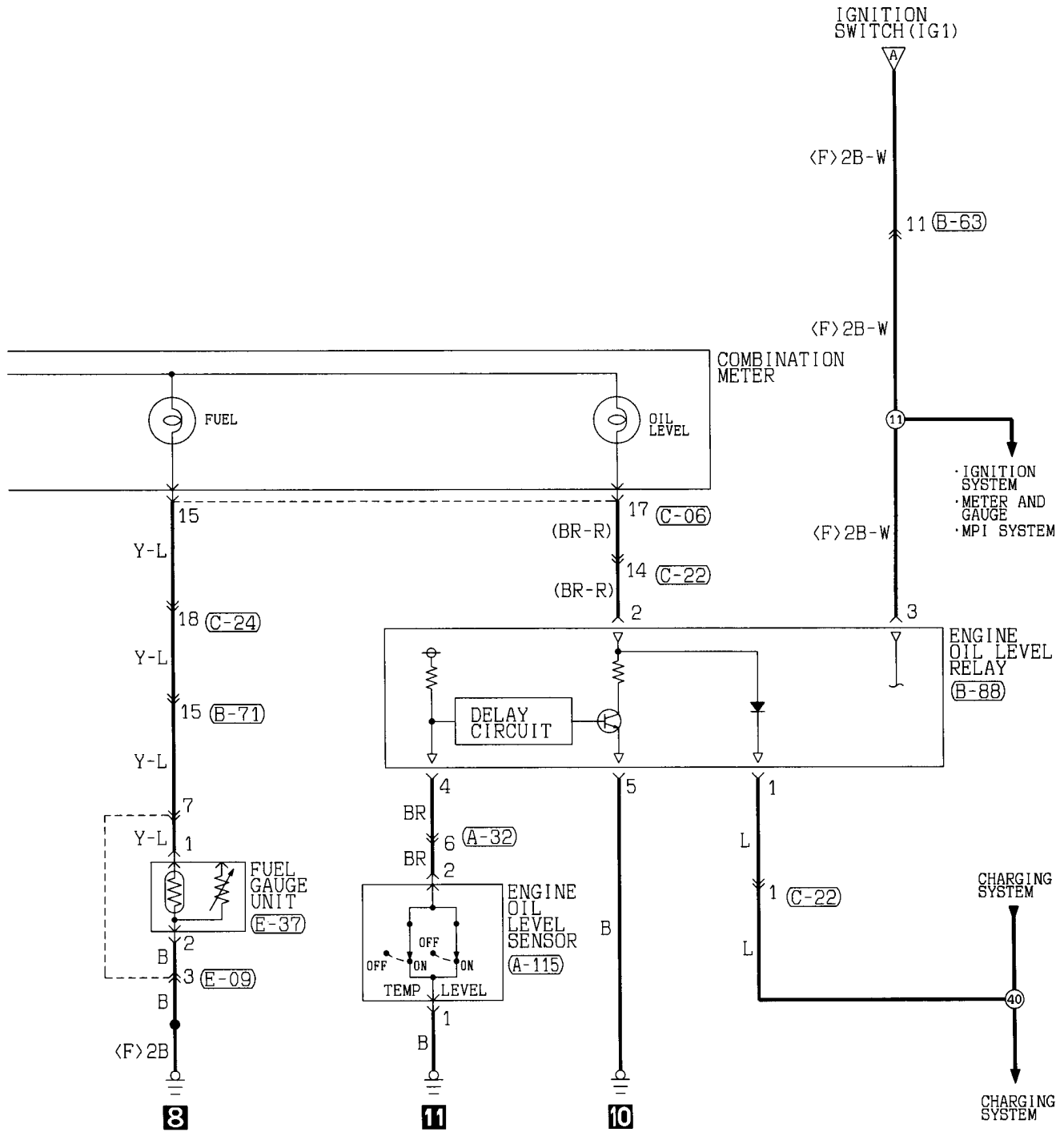

(B-88)	(C-04)	(C-06)	(C-17)	(C-21)	(C-22)	(C-24)
1 2 3 4 5 6	41 42 43 44 45 46 47 48 49	1 2 3 4 5 6 7 8	1	1 2 3 4 5 6 7 8 9 10 11 12 13 14 15 16 17 18 19 20	1 2 3 4 5 6 7 8 9 10 11 12 13 14 15 16 17 18	1 2 3 4 5 6 7 8 9 10 11 12 13 14 15 16 17 18 19 20 21 22
50 51 52 53 54 55 56 57	10 11 12 13 14 15 16 17					

Wire colour code
 B:Black LG:Light green G:Green L:Blue W:White Y:Yellow SB:Sky blue
 BR:Brown O:Orange GR:Gray R:Red P:Pink V:Violet

BRAKE WARNING LAMP (See P. 4-66.)**OIL PRESSURE WARNING LAMP (See P. 4-66.)****FUEL WARNING LAMP (See P. 4-67.)****ENGINE OIL LEVEL WARNING LAMP (See P. 4-67.)****OPERATION****<Oil pressure warning lamp>**

- When the lubrication system fails after engine starting, resulting in the oil pressure failing to build up, the oil pressure switch turns on causing the oil pressure warning lamp to illuminate.

<Fuel warning lamp>

- When the ignition switch is at the ON position and the fuel level drops, the resistance of the unit increases. When the resistance rises to a value that is higher than the specified value, the fuel warning lamp illuminates to inform the driver that the fuel level is low.

<Brake warning lamp>

- When the brake fluid level goes down below a predetermined level with the ignition switch in the ON position, the brake fluid level sensor is activated or the parking brake switch is turned on, causing the brake warning lamp to illuminate.

<Engine oil level warning lamp>

- When the ignition switch is turned to the ON position (in the state where the engine is stopped), electric current will flow to terminal "L" of the alternator through the multi-purpose fuse No. (8), low engine oil warning lamp and engine oil level relay and the engine oil level warning lamp will also illuminate.
- When the engine starts, the charging voltage will be applied to the terminal "L" of the alternator. Therefore, the engine oil level warning lamp will switch off.
- When the engine oil temperature rises to approx. 55°C, the engine oil level sensor (TEMP) in the oil pan will be turned off.
- When the engine oil amount in the oil pan drops below the set level in this state, the engine oil level sensor (LEVEL) will be turned off to apply the voltage to the delay circuit.
- If the OFF state continues for approx. 20 seconds or more, the power transistor will be turned on to light the engine oil level warning lamp to indicate a shortage of engine oil.

Remark

The delay circuit prevents the engine oil level warning lamp from illuminating even if the engine oil level sensor is temporarily turned off due to cornering or other running conditions of the vehicle.

NOTES

CENTRAL DOOR LOCKING SYSTEM

90100470262

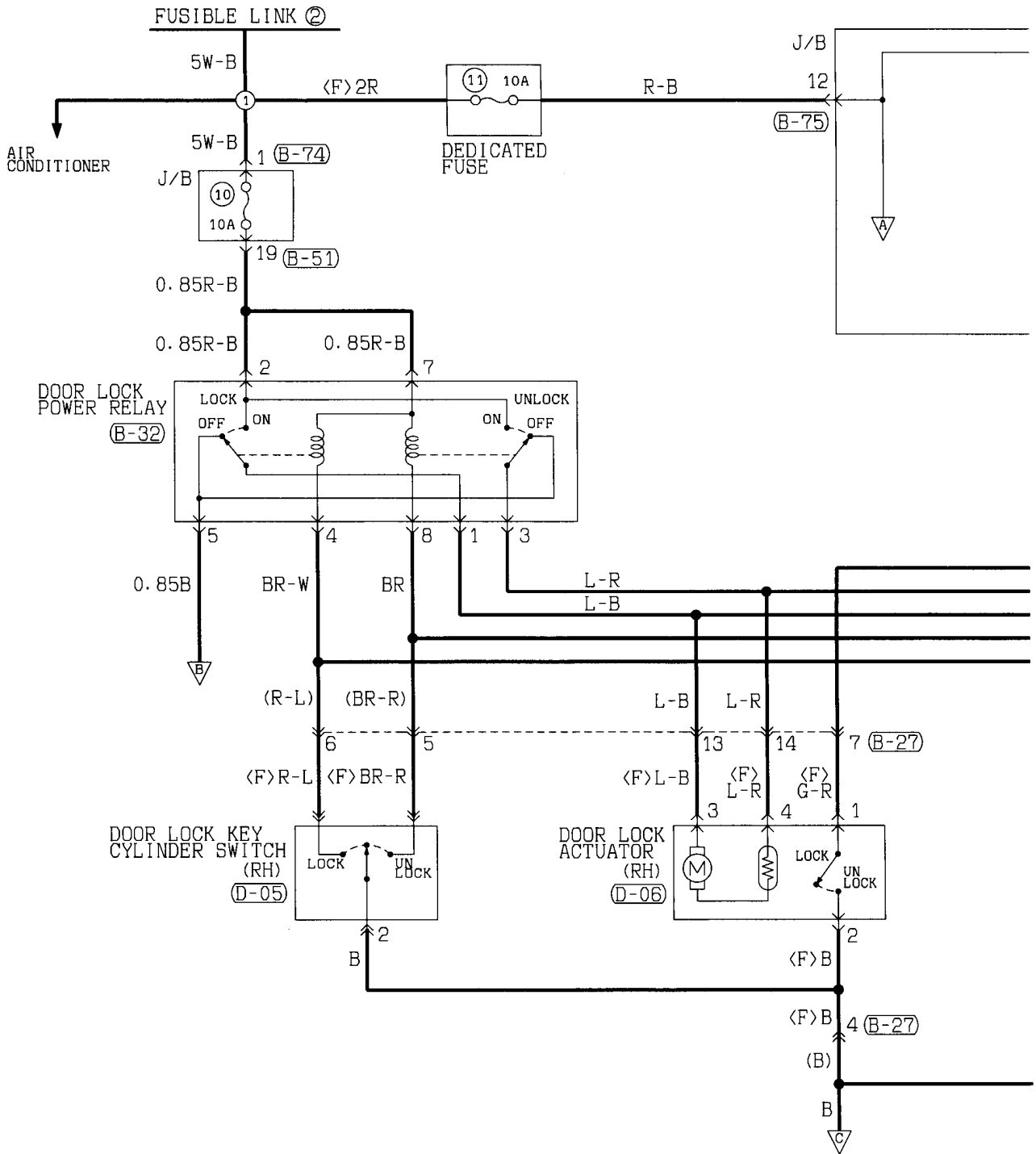

B-07

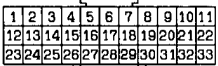

B-27

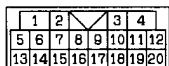

B-32

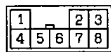

B-38 FRONT SIDE

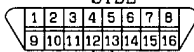

B-47

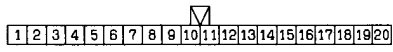

D-06



D-07



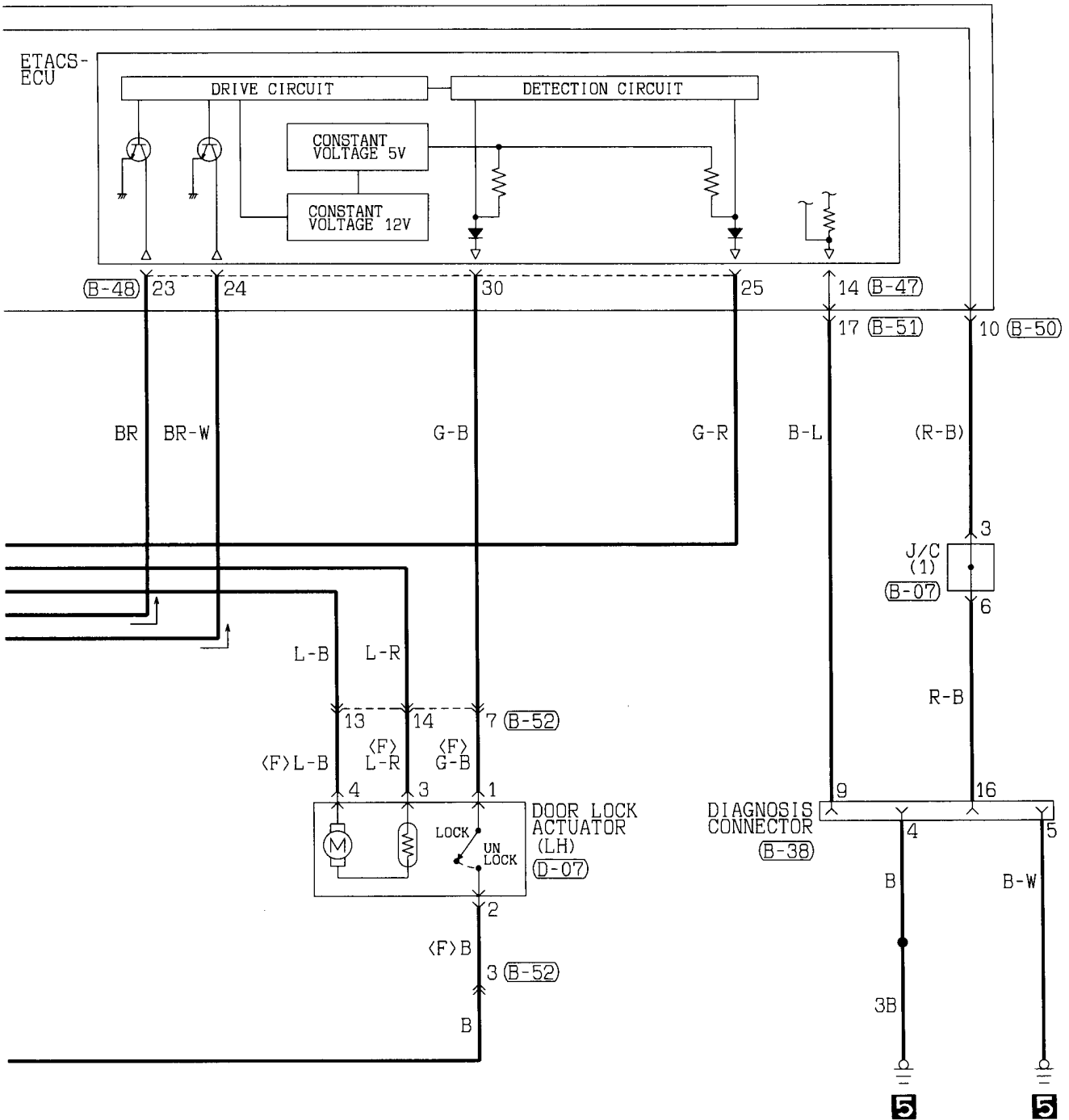

(B-48)

21	22	23	24	25	26	27	28
29	30	31	32	33	34	35	36

(B-50)

1	2	3	4	5	6	7	8		
9	10	11	12	13	14	15	16	17	18

(B-51)

1	2	3	4	5	6	7	8	9		
10	11	12	13	14	15	16	17	18	19	20

(B-52)

1	2	3	4				
5	6	7	8	9	10	11	12
13	14	15	16	17	18	19	20

(B-74)

1

(B-75)

1	2	3	4	5	6	7	8		
9	10	11	12	13	14	15	16	17	18

(D-05)

1	2	3
---	---	---

Wire colour code
 B:Black LG:Light green G:Green L:Blue W:White Y:Yellow SB:Sky blue
 BR:Brown O:Orange GR:Gray R:Red P:Pink V:Violet

CENTRAL DOOR LOCKING SYSTEM (CONTINUED)

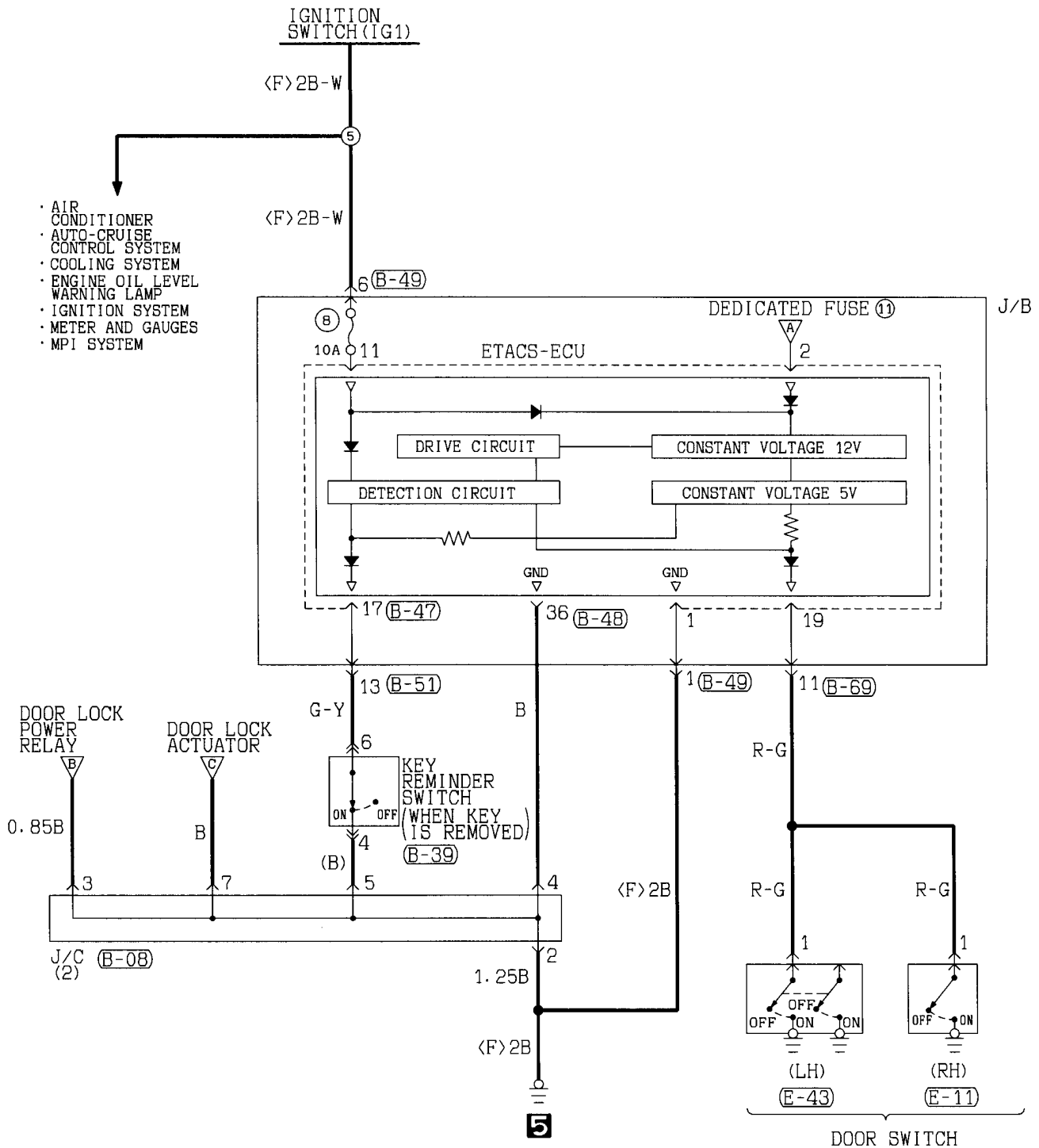

(B-08)

1	2	3	4	5	6	7	8	9	10	11
12	13	14	15	16	17	18	19	20	21	22
23	24	25	26	27	28	29	30	31	32	33

(B-39)

1	2	
3	4	
5	6	7

(B-47)

1	2	3	4	5	6	7	8	9	10	11	12	13	14	15	16	17	18	19	20
---	---	---	---	---	---	---	---	---	----	----	----	----	----	----	----	----	----	----	----

(B-48)

21	22	23	24	25	26	27	28
29	30	31	32	33	34	35	36

(B-49)

1	2	3	4
5	6	7	8
9	10		

(B-51)

1	2	3	4	5	6	7	8	9
10	11	12	13	14	15	16	17	18
19	20							

(B-69)

1	2	3	4	5	6	7	8	9
10	11	12	13	14	15	16	17	18
19								

(E-11) (E-43)

1	2
---	---

1	2
---	---

POWER WINDOWS

90100460139

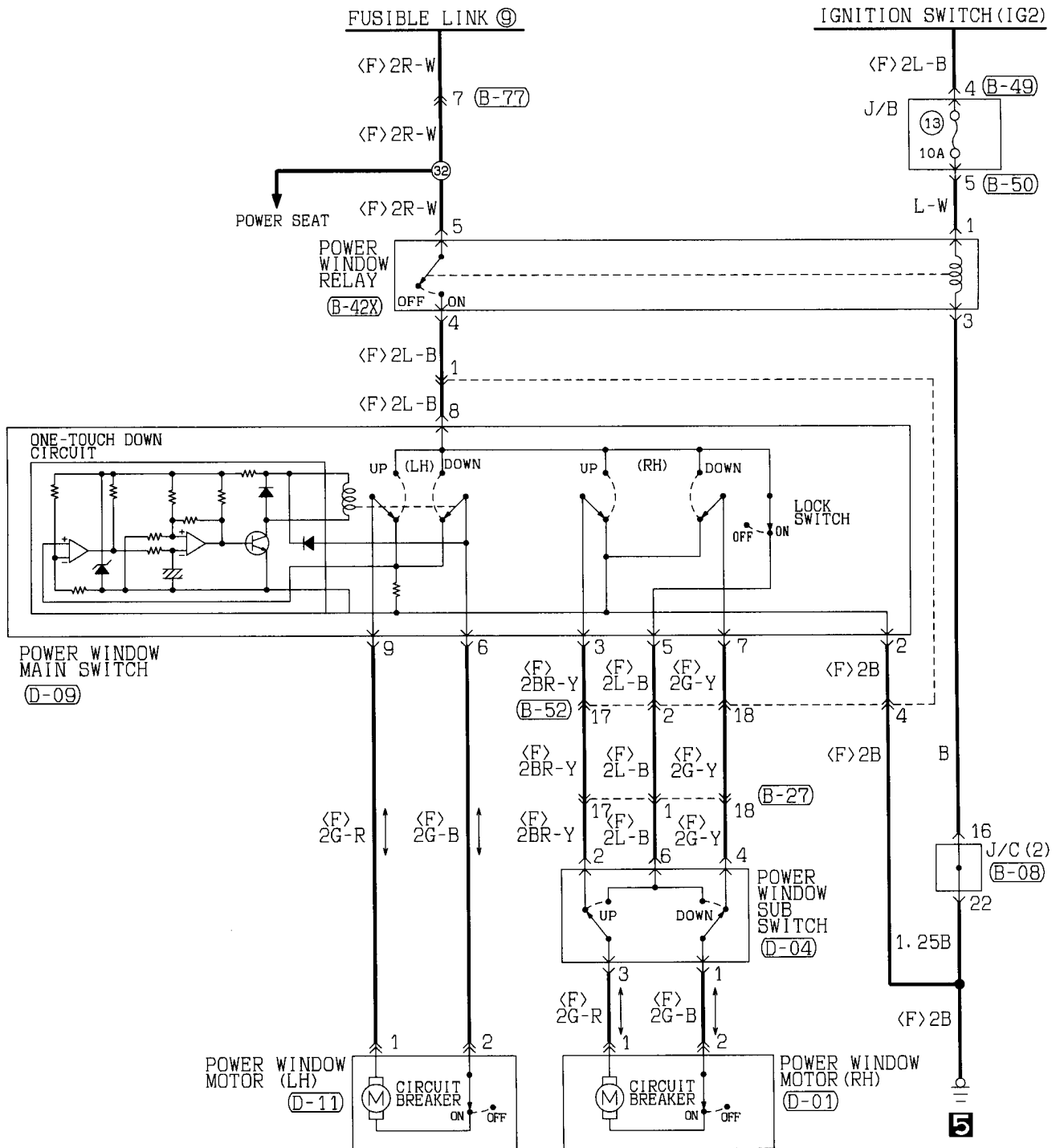

(B-08)

1	2	3	4	5	6	7	8	9	10	11
12	13	14	15	16	17	18	19	20	21	22
23	24	25	26	27	28	29	30	31	32	33

(B-27)

1	2	3	4
5	6	7	8
9	10	11	12
13	14	15	16
17	18	19	20

(B-42X)

1	2	3
4	5	

(B-49)

1	2	3	4
5	6	7	8
9	10		

(B-50)

1	2	3	4	5	6	7	8
9	10	11	12	13	14	15	16
17	18						

(B-52)

1	2	3	4
5	6	7	8
9	10	11	12
13	14	15	16
17	18	19	20

(B-77)

1	2	3
4	5	6
7	8	

(D-01)

1	2
---	---

(D-04)

1	2	3
4	5	6
7	8	9

(D-09)

1	2	3
4	5	6
7	8	9

(D-11)

1	2
---	---

Wire colour code
 B:Black
 BR:Brown
 W:White
 V:Violet

LG:Light green
 O:Orange
 SB:Sky blue

G:Green
 GR:Gray
 P:Pink

L:Blue
 R:Red
 Y:Yellow

HEATER

90101330040

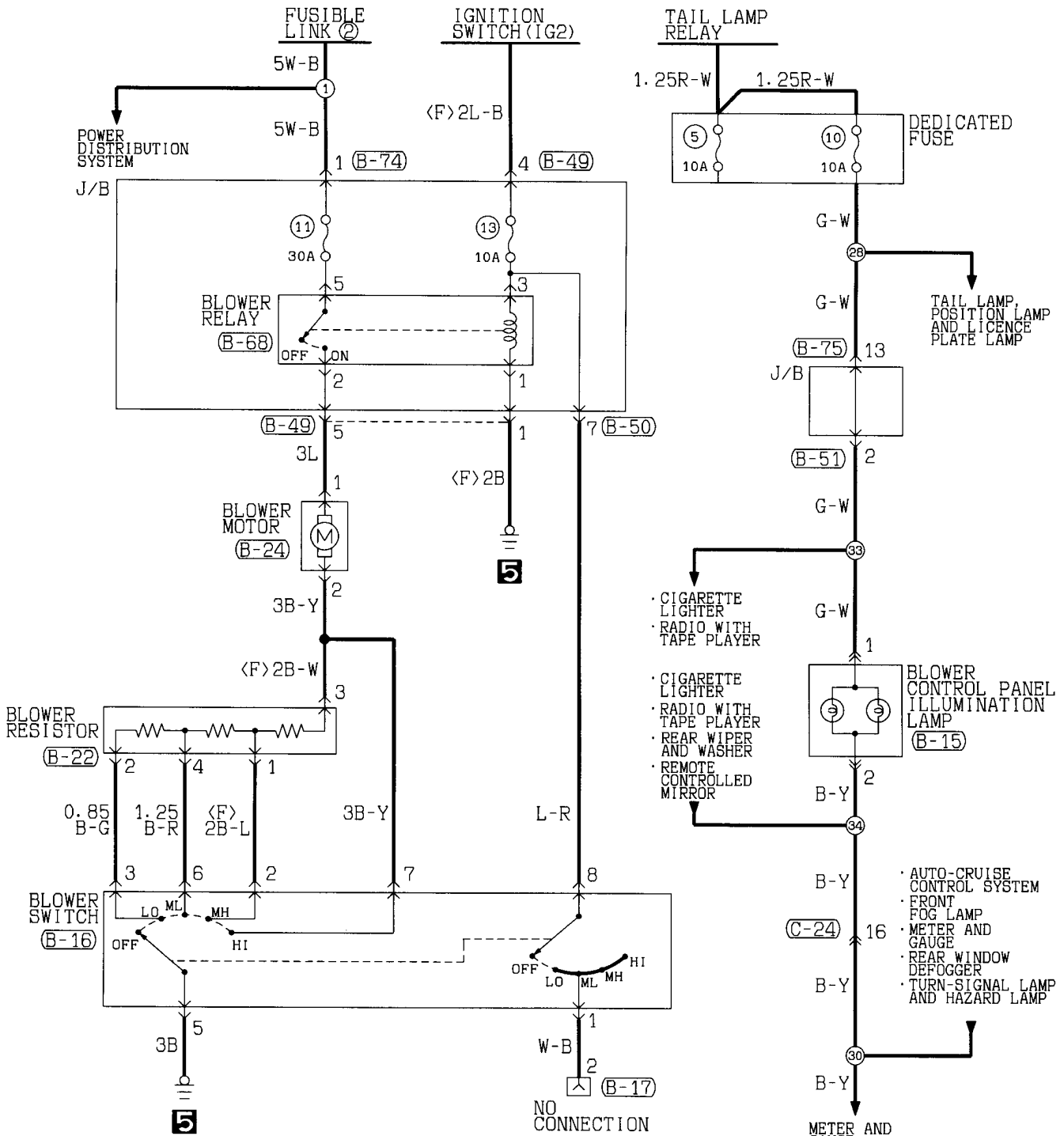

(B-15) (B-16) (B-17) (B-22) (B-24) (B-49) (B-50) (B-51) (B-68) (B-74)

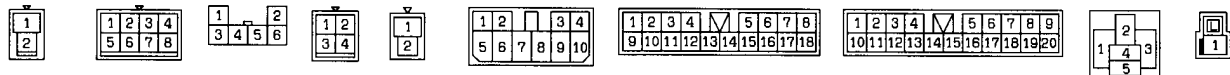

(C-24)

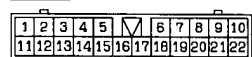

Wire colour code
 B:Black LG:Light green G:Green L:Blue W:White Y:Yellow SB:Sky blue
 BR:Brown O:Orange GR:Gray R:Red P:Pink V:Violet

HEATER (See P. 4-74.)**OPERATION**

- When the ignition switch is turned ON, the blower relay is energized. If the blower switch is turned ON (LO, ML, MH, or HI position) in this condition, the blower is activated through the circuit via resistor at a speed corresponding to the blower switch position.

TROUBLESHOOTING HINTS

1. Blower motor is energized at one switch position and not energized at another.
 - Check harness and connectors between defective switch position and resistor (or blower motor in HI position).
2. Blower motor is energized only when switch is positioned in HI.
 - Check resistor.
3. Blower motor speed does not represent the switch position.
 - Check blower switch.

AIR CONDITIONER

90100550072

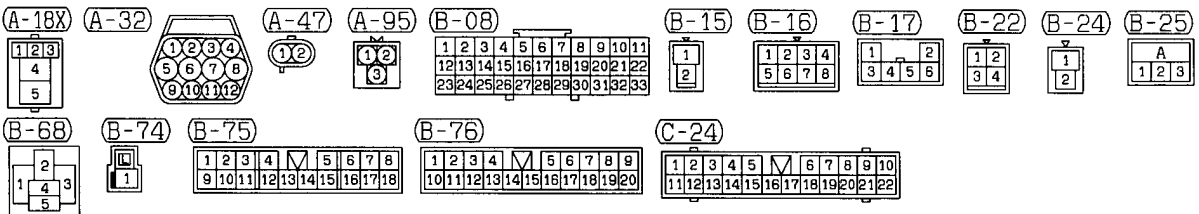
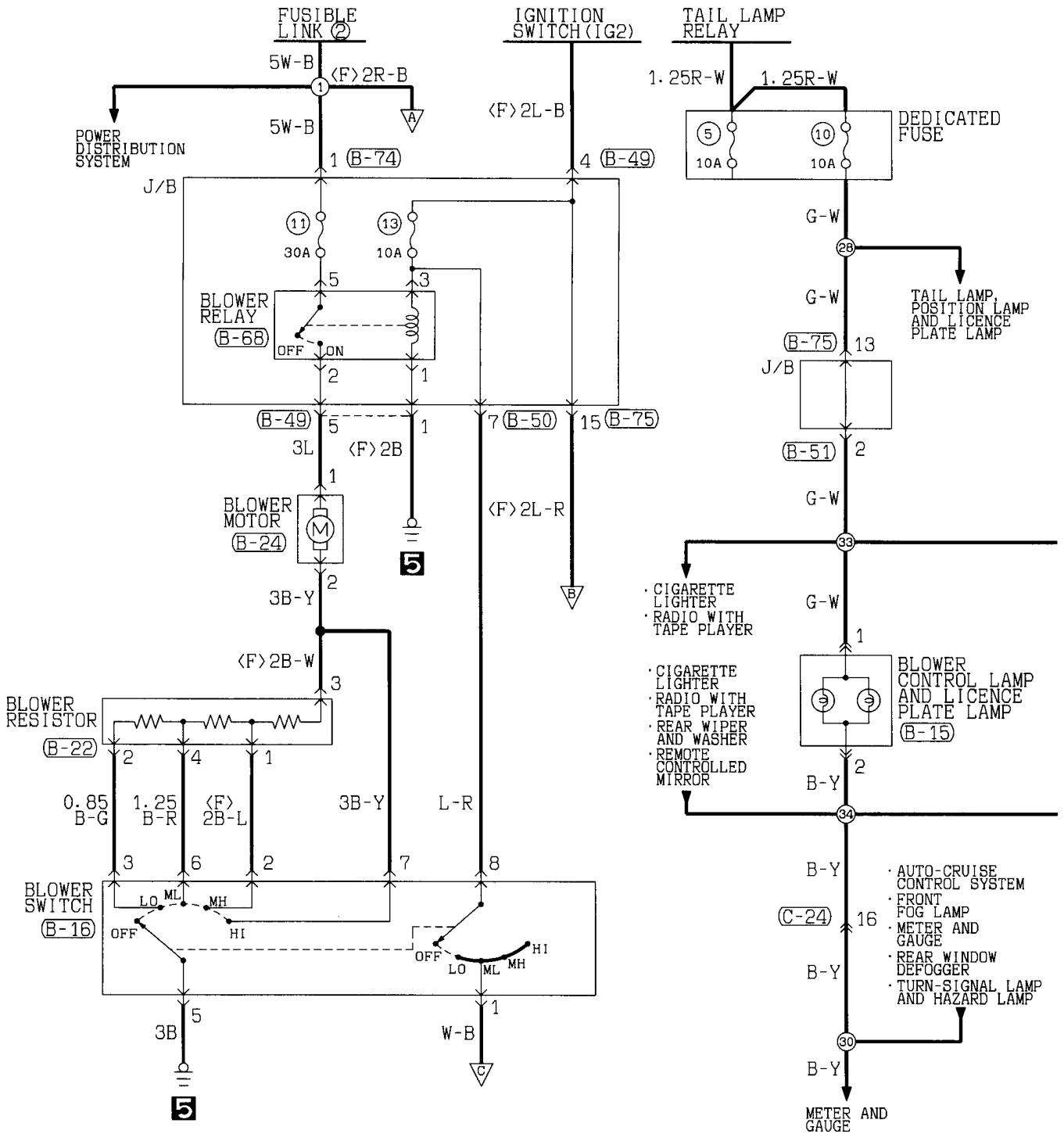

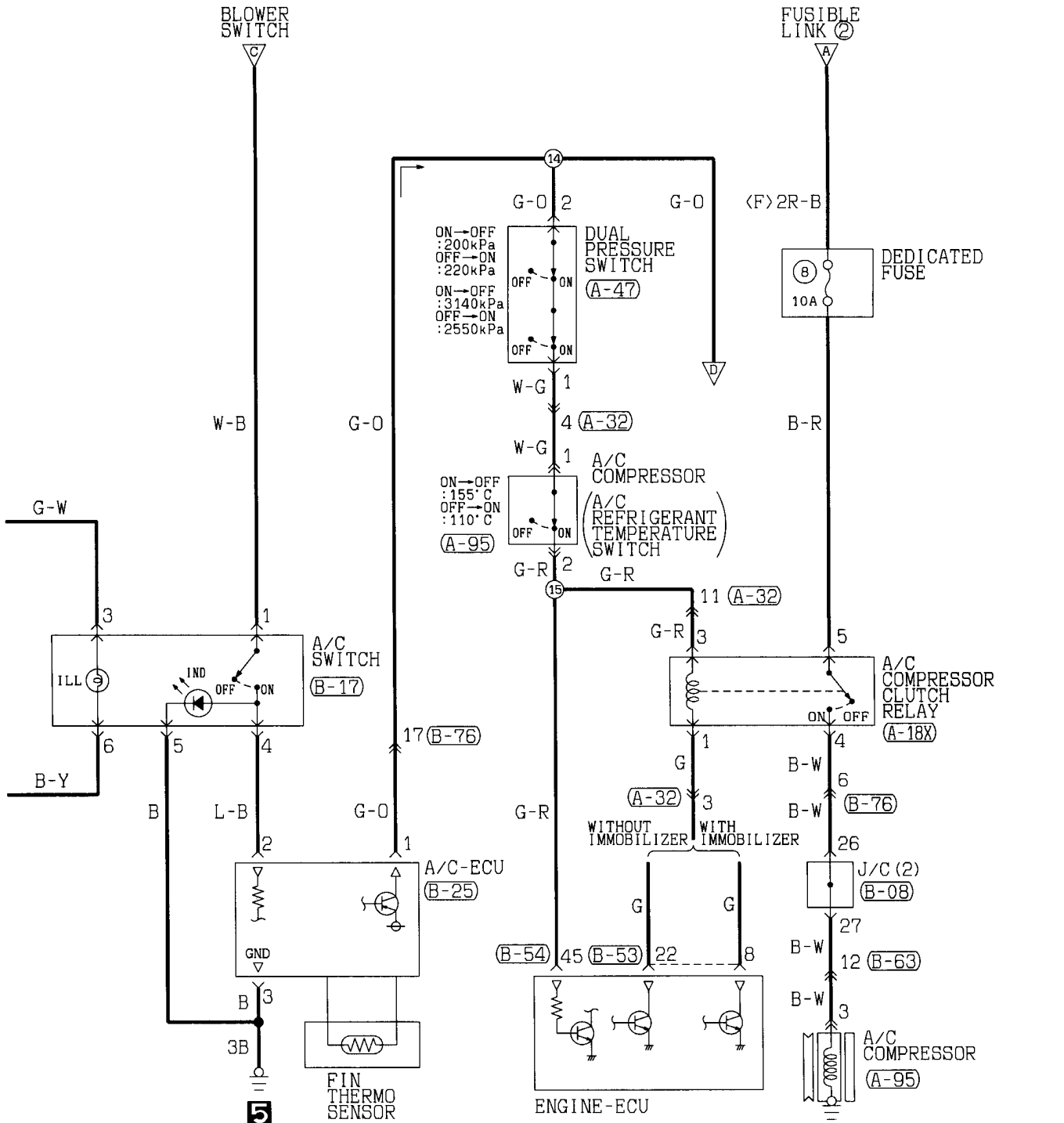

(B-49)

1	2	3	4
5	6	7	8
9	10	11	12

(B-50)

1	2	3	4	5	6	7	8
9	10	11	12	13	14	15	16
17	18	19	20	21	22	23	24

(B-51)

1	2	3	4	5	6	7	8	9
10	11	12	13	14	15	16	17	18
19	20	21	22	23	24	25	26	27

(B-53)

1	2	3	4	5	6	7	8	9	10	11	12	13
14	15	16	17	18	19	20	21	22	23	24	25	26

(B-54)

31	32	33	34	35	36	37	38
39	40	41	42	43	44	45	46

(B-63)

1	2	3	4	5	6	7	8	9	10
11	12	13	14	15	16	17	18	19	20
21	22	23	24	25	26	27	28	29	30

Wire colour code
 B:Black LG:Light green G:Green L:Blue W:White Y:Yellow SB:Sky blue
 BR:Brown O:Orange GR:Gray R:Red P:Pink V:Violet

AIR CONDITIONER (CONTINUED)

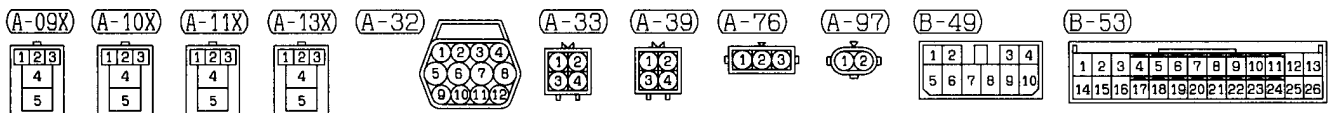
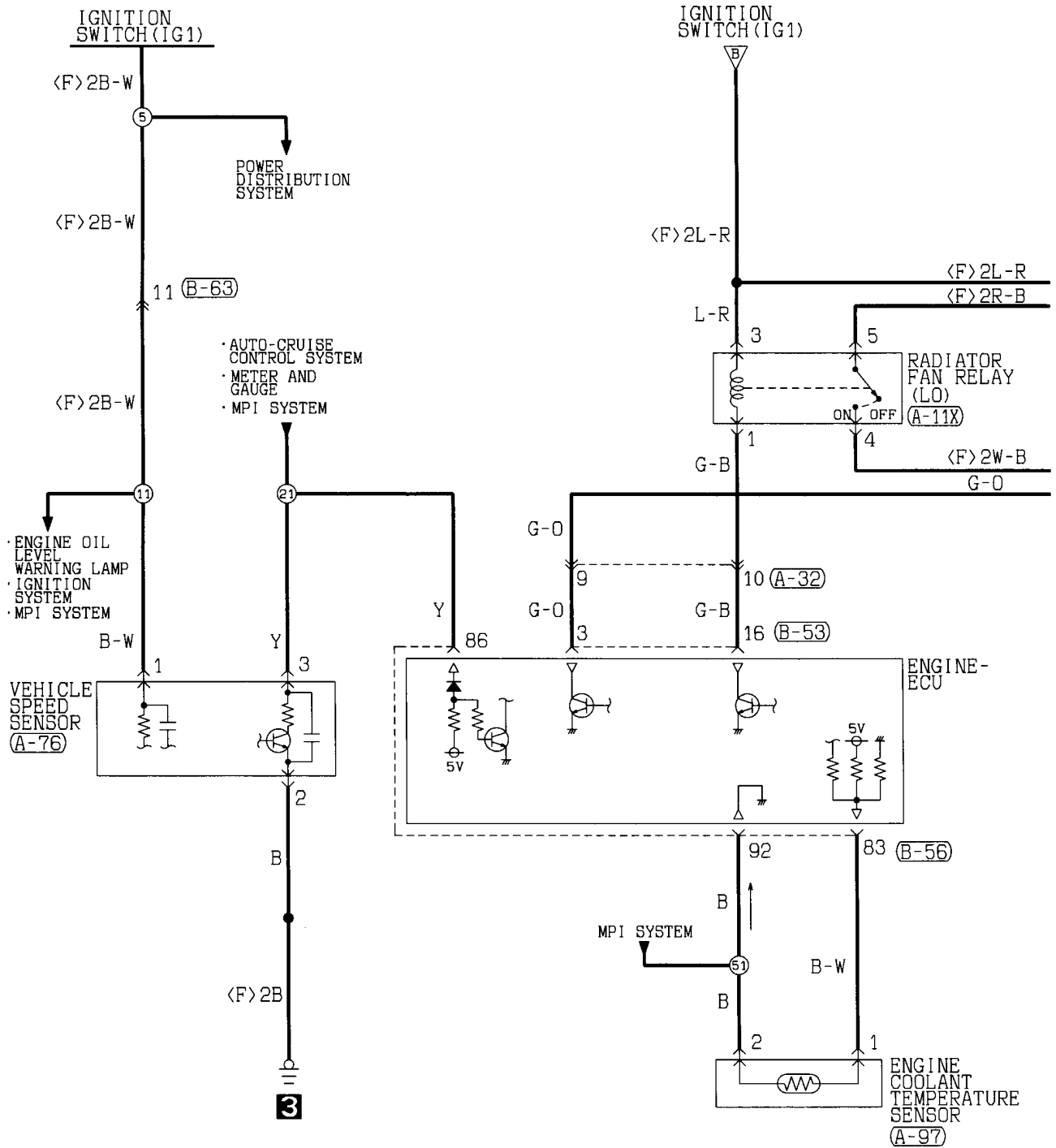

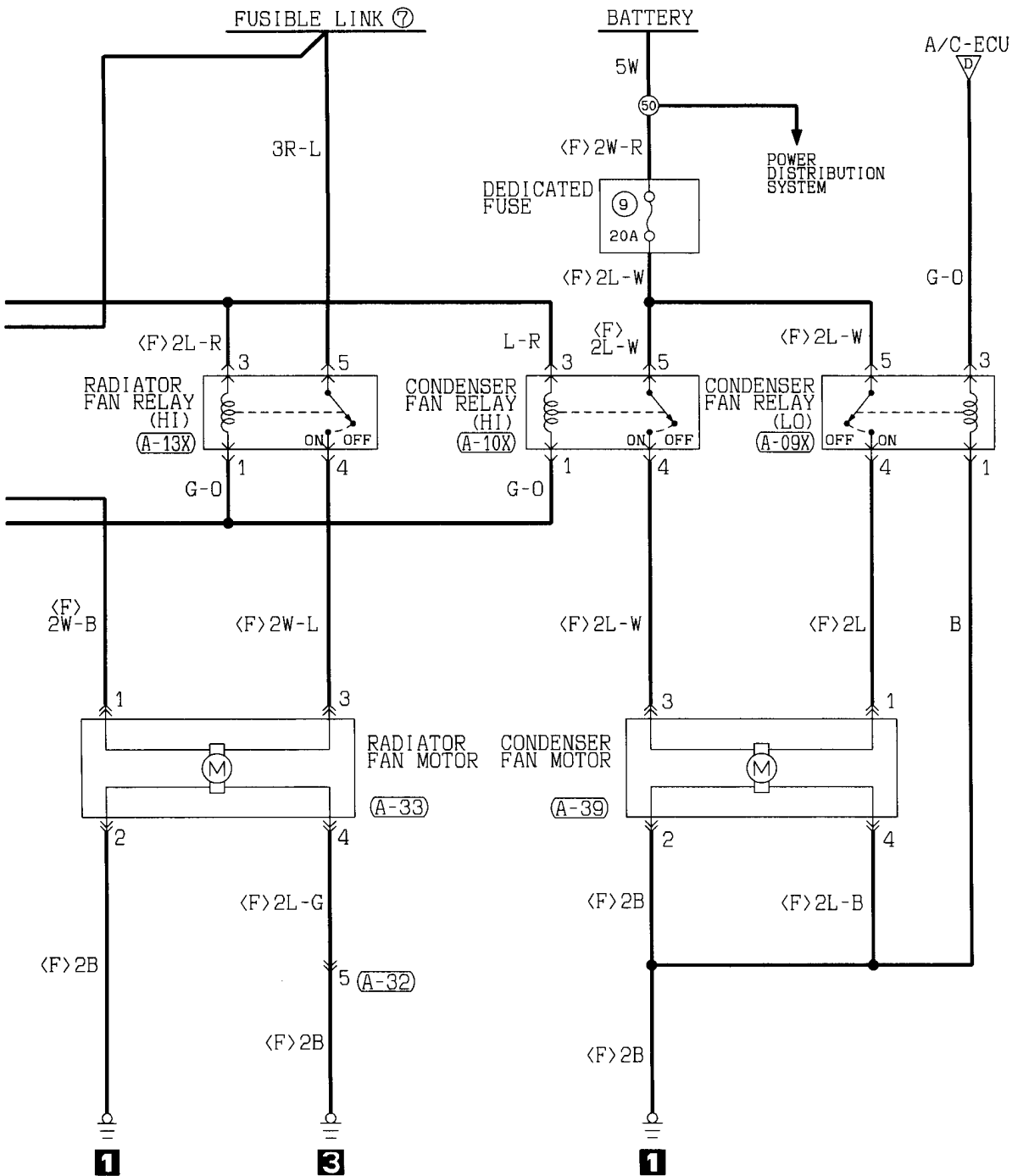

(B-56)

71	72	73	74	75	76	77	78	79	80	81
82	83	84	85	86	87	88	89	90	91	92

(B-63)

1	2	3	4	5	M	6	7	8	9	10	
11	12	13	14	15	16	17	18	19	20	21	22

(B-75)

1	2	3	4	M	5	6	7	8	
9	10	11	12	13	14	15	16	17	18

Wire colour code
 B:Black LG:Light green G:Green L:Blue W:White Y:Yellow SB:Sky blue
 BR:Brown O:Orange GR:Gray R:Red P:Pink V:Violet

WINDSHIELD WIPER AND WASHER

90100610138

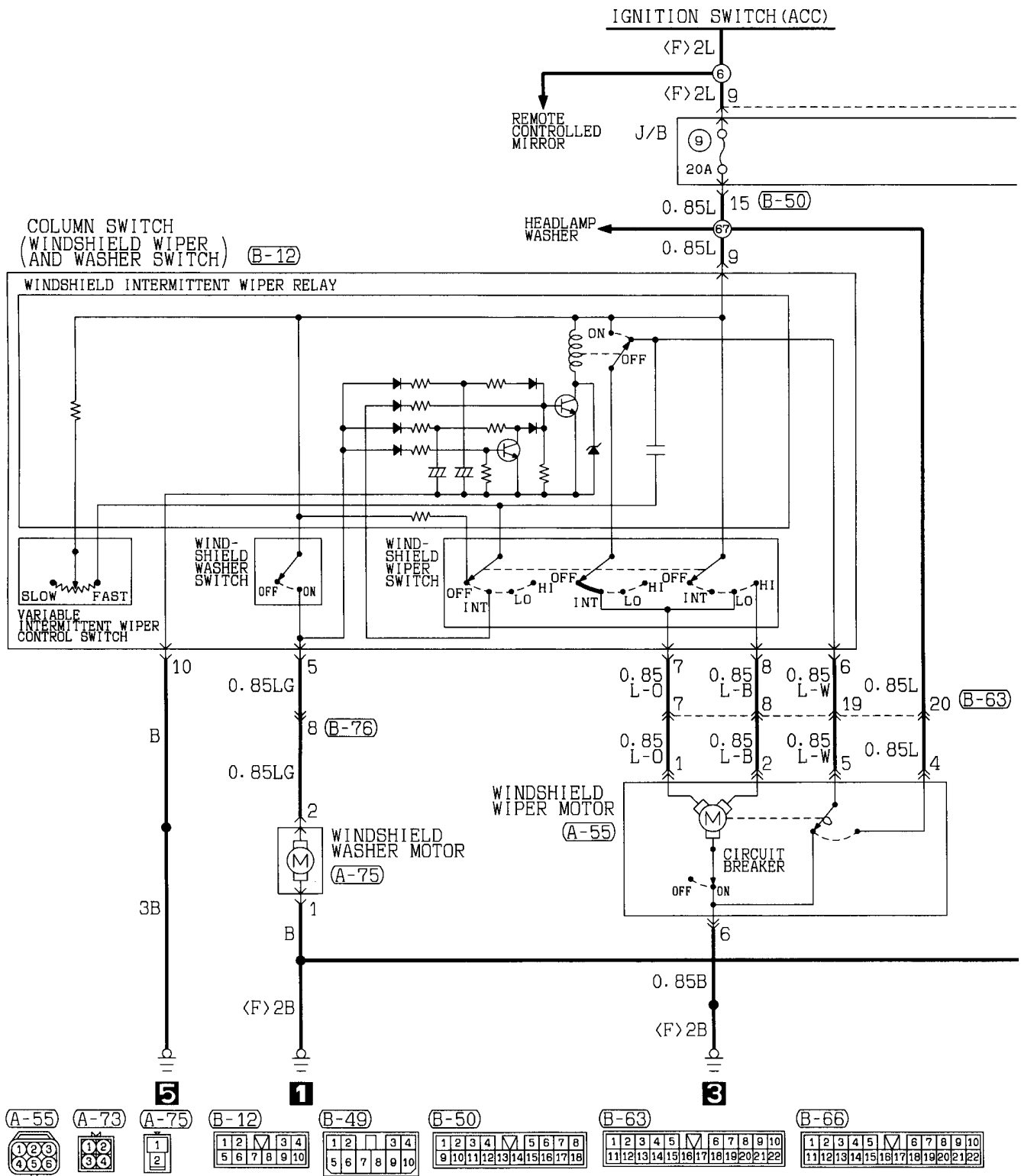

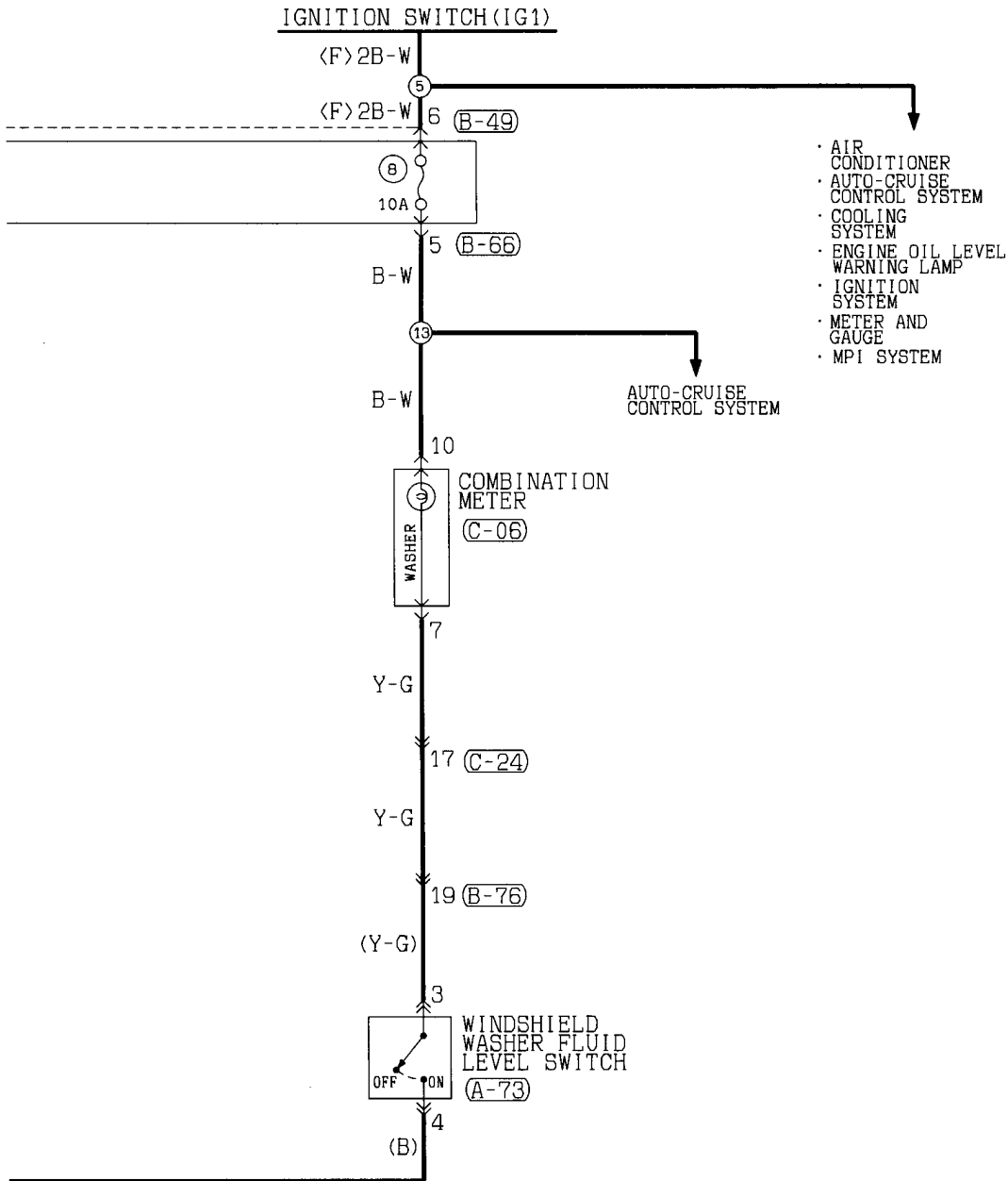

(B-76)

1	2	3	4	M	5	6	7	8	9	
10	11	12	13	14	15	16	17	18	19	20

(C-06)

1	2	3	4	5	6	7	8
9							
10	11	12	13	14	15	16	17

(C-24)

1	2	3	4	5	M	6	7	8	9	10	
11	12	13	14	15	16	17	18	19	20	21	22

Wire colour code
 B:Black LG:Light green G:Green L:Blue W:White Y:Yellow SB:Sky blue
 BR:Brown O:Orange GR:Gray R:Red P:Pink V:Violet

WINDSHIELD WIPER AND WASHER (See P. 4-80.)**OPERATION****<Low-speed (and high-speed) wiper operation>**

- When the wiper switch is placed in the LO position with the ignition switch in the ACC or ON position, wipers operate continuously at low speed.
- Placing the wiper switch in the HI position causes the wipers to operate at high speed.

<Automatic wiper stopping operation>

- When the wiper switch is placed in the OFF position, the cam contacts of wiper motor caused current to flow through the automatic wiper stopping circuit, allowing the wiper blades to cycle before they reach to the stop positions.

TROUBLESHOOTING HINTS

- Wipers do not operate.
 - Washer is not operative, either.
 - Check multi-purpose fuse No. (19).
 - Check earth.
- Low-speed (or high-speed) wiper operation only is inoperative.
 - Check wiper switch.
- Wipers do not stop.
 - Check wiper motor.
 - Check intermittent wiper relay.
 - Check wiper switch.
- Intermittent wiper operation is inoperative.
 - Check terminal voltage of steering-column switch (with a built-in intermittent wiper relay) with the intermittent wiper relay energized. (see below)
- The length of pause for intermittent operation cannot be varied.
 - Check variable intermittent wiper control switch.
 - Check intermittent wiper relay.
- Washer is inoperative.
 - Wiper is operative on washer-activated wiper operation.
 - Check washer motor.
 - Washer-activated wiper operation is inoperative also.
 - Check washer switch.
- Washer-activated wiper operation is inoperative.
 - Check intermittent wiper relay.

<Intermittent wiper operation>

- When the wiper switch is placed in the INT position with the ignition switch in ACC or ON position, the intermittent wiper relay is energized causing the intermittent wiper relay contacts to close and open repeatedly.
- When the contacts are closed, the wiper motor is energized.
- When the wiper motor is energized, the relay contacts open, however, the cam contacts keep the wiper motor energized until the wiper blades return to their stop position.

<Washer-activated wiper operation>

- When the washer switch is turned on, the intermittent wiper relay contacts close, causing wipers to cycle two to three times.

Terminal No.	Voltage	Check
7	0V	Intermittent wiper relay or wiper switch
	System voltage	Intermittent wiper relay
	0V ↔ System voltage (alternating)	– (Normal)

REAR WIPER AND WASHER (See P. 4-84.)

OPERATION

- When the rear wiper switch is placed in the INT or LO position with the ignition switch in the ACC or ON position, wipers operate continuously.

<Automatic wiper stopping operation>

- When the wiper switch is placed in the OFF position, the cam contacts of wiper motor causes current to flow through the automatic wiper stopping circuit, allowing the wiper blades to cycle before they reach the stop positions.

<Intermittent wiper operation>

- When the wiper switch is placed in the INT position with the ignition switch in ACC or ON position, the intermittent wiper relay is energized causing the intermittent wiper relay contacts to close and open repeatedly.
- When the contacts are closed, the wiper motor is energized.
- When the wiper motor is energized, the relay contacts open. However, the cam contacts keep the wiper motor energized until the wiper blades return to their stop position.

TROUBLESHOOTING HINTS

1. Wipers do not operate.
 - (1) Washer is not operative, either.
 - Check multi-purpose fuse No. (9).
 - Check earth.
 - Check wiper switch.
2. Wipers do not stop.
 - Check wiper motor.
 - Check intermittent wiper relay.
 - Check wiper switch.
3. Intermittent wiper operation is inoperative.
 - While the intermittent wiper relay is being operated, check terminal voltage of the intermittent wiper relay energized. (Refer to the table below.)
4. Washer is inoperative.
 - Check washer motor.
 - Check washer switch.

HEADLAMP WASHER (See P. 4-88)

OPERATION

- When the headlamp washer switch is turned ON with ignition switch in ACC or ON and lighting switch in HEAD position, the headlamp washer relay is energized causing the headlamp washer motor to start.

Terminal No.	Voltage	Check
6	0V	Intermittent wiper relay or wiper switch
	System voltage	Intermittent wiper relay
	0V ↔ System voltage (alternating)	– (Standard)

REAR WIPER AND WASHER

90100620131

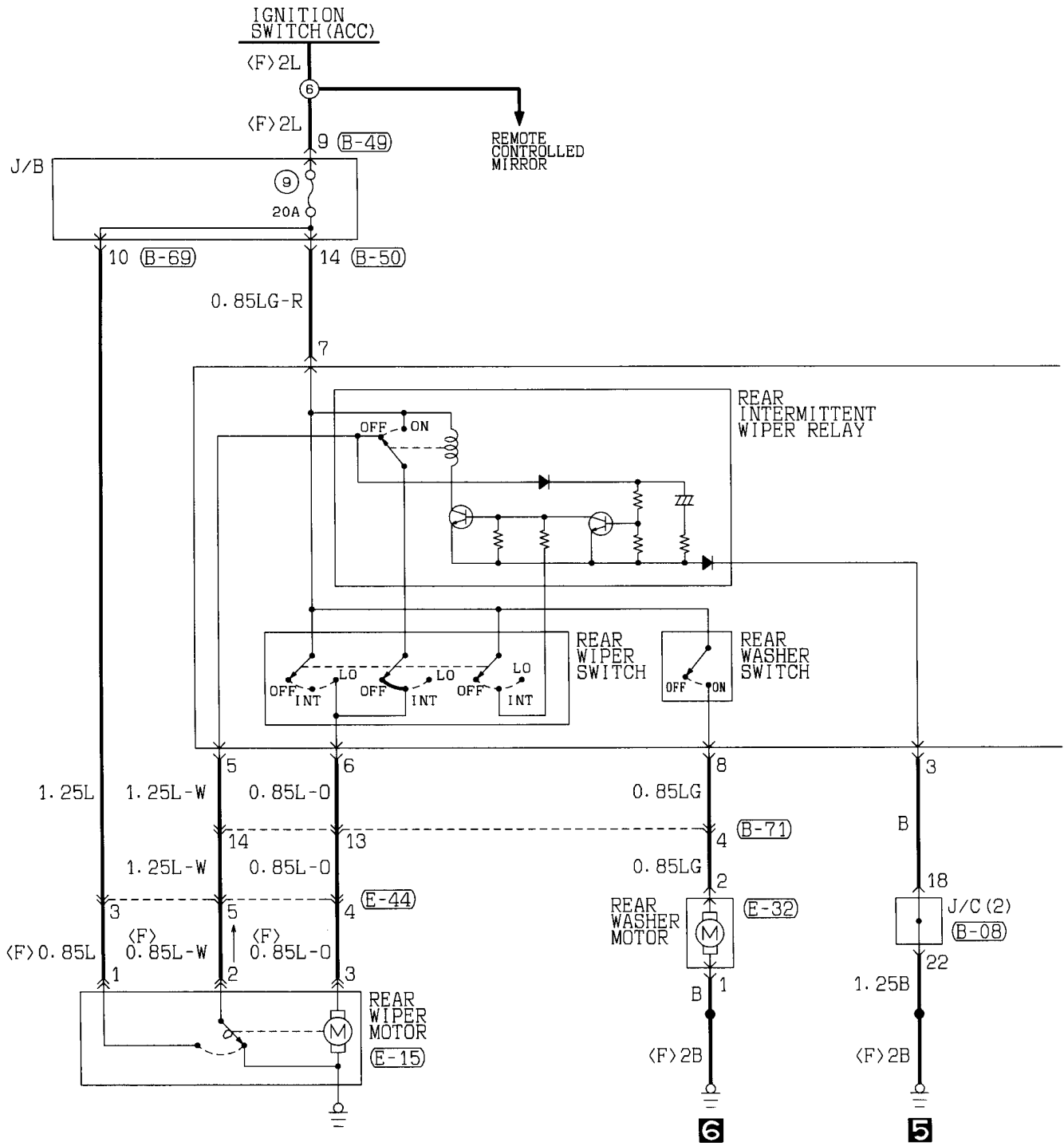

(B-08)

1	2	3	4	5	6	7	8	9	10	11
12	13	14	15	16	17	18	19	20	21	22
23	24	25	26	27	28	29	30	31	32	33

(B-49)

1	2	3	4
5	6	7	8
9	10		

(B-50)

1	2	3	4	M	5	6	7	8
9	10	11	12	13	14	15	16	17
18	19	20						

(B-51)

1	2	3	4	M	5	6	7	8	9
10	11	12	13	14	15	16	17	18	19
20									

(B-69)

1	2	3	4	M	5	6	7	8	9
10	11	12	13	14	15	16	17	18	19

Wire colour code

B:Black LG:Light green G:Green L:Blue W:White Y:Yellow SB:Sky blue
 BR:Brown O:Orange GR:Gray R:Red P:Pink V:Violet

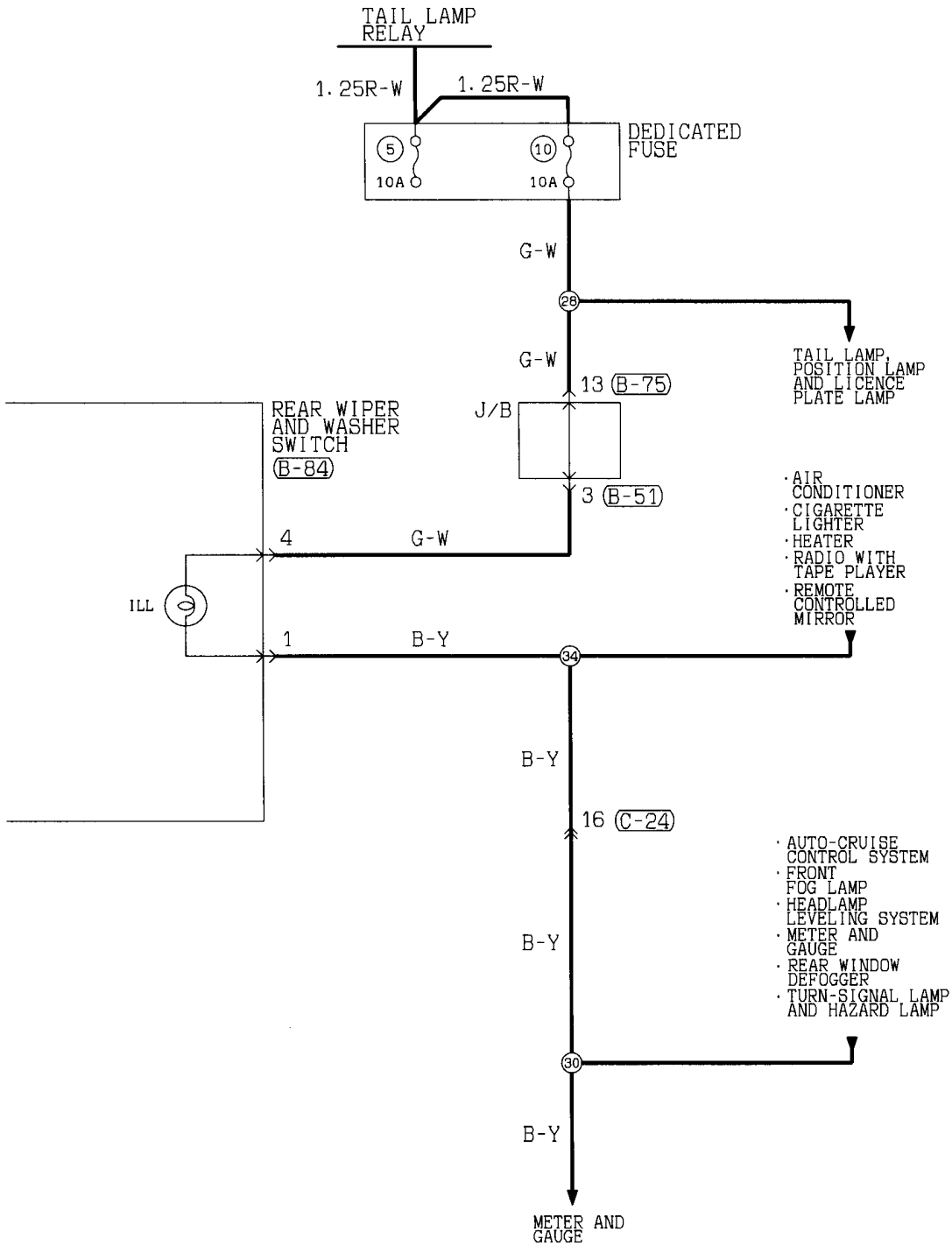

(B-71)

1	2	3	4	5	6	7	8	9	10		
11	12	13	14	15	16	17	18	19	20	21	22

(B-75)

1	2	3	4	5	6	7	8		
9	10	11	12	13	14	15	16	17	18

(B-84)

1	2	3		
4	5	6	7	8

(C-24)

1	2	3	4	5	6	7	8	9	10		
11	12	13	14	15	16	17	18	19	20	21	22

(E-15)

1	2	3
---	---	---

(E-32)

1
2

(E-44)

1	2		
3	4	5	6

REAR WINDOW DEFOGGER

90100640137

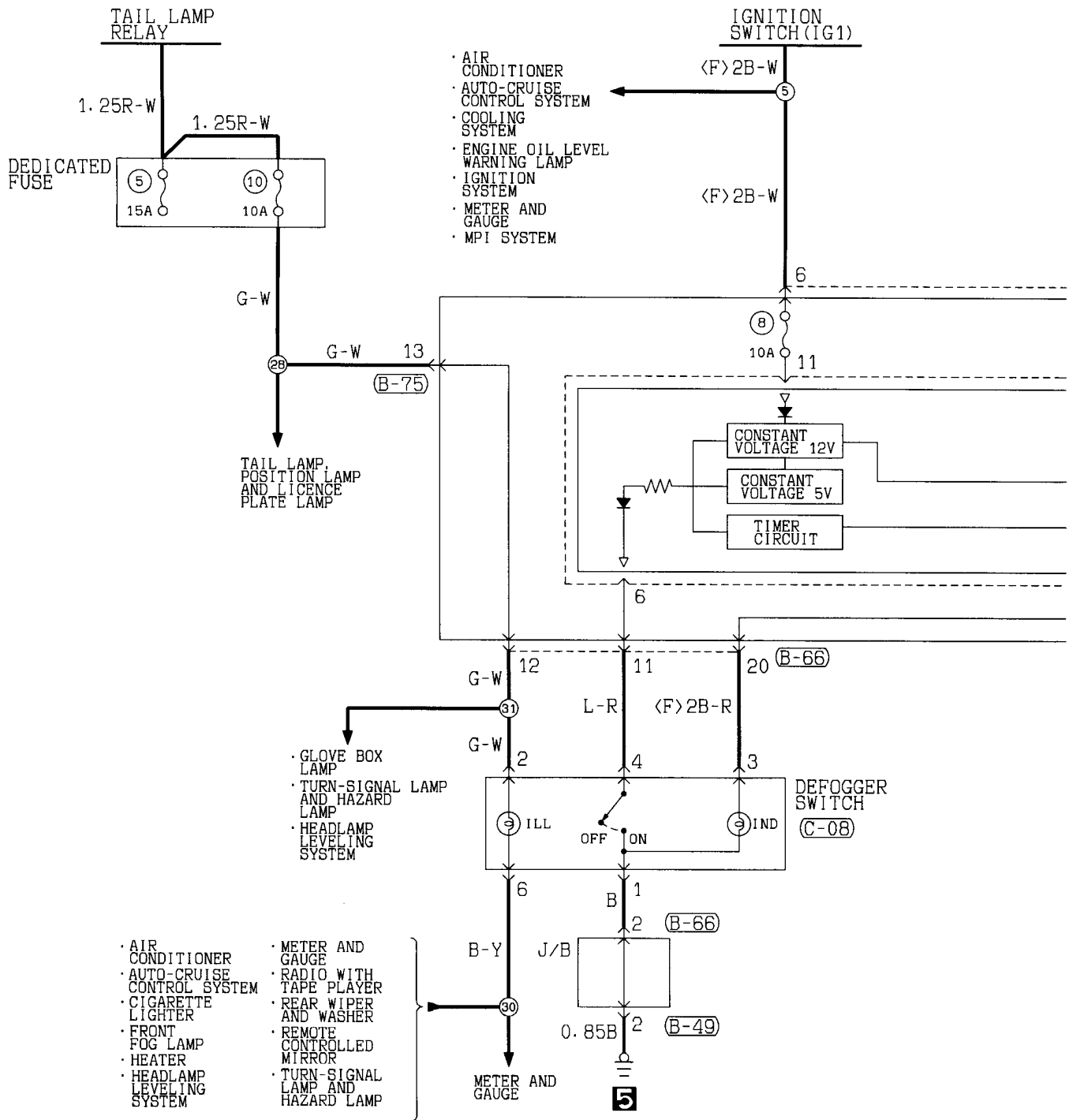

(B-07)

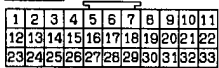

(B-08)



(B-38) FRONT SIDE

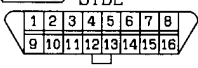

(B-47)

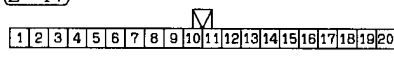

(B-48)

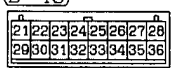

(B-75)

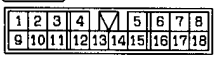

(C-08)



(E-10)



(E-14)



(E-44)



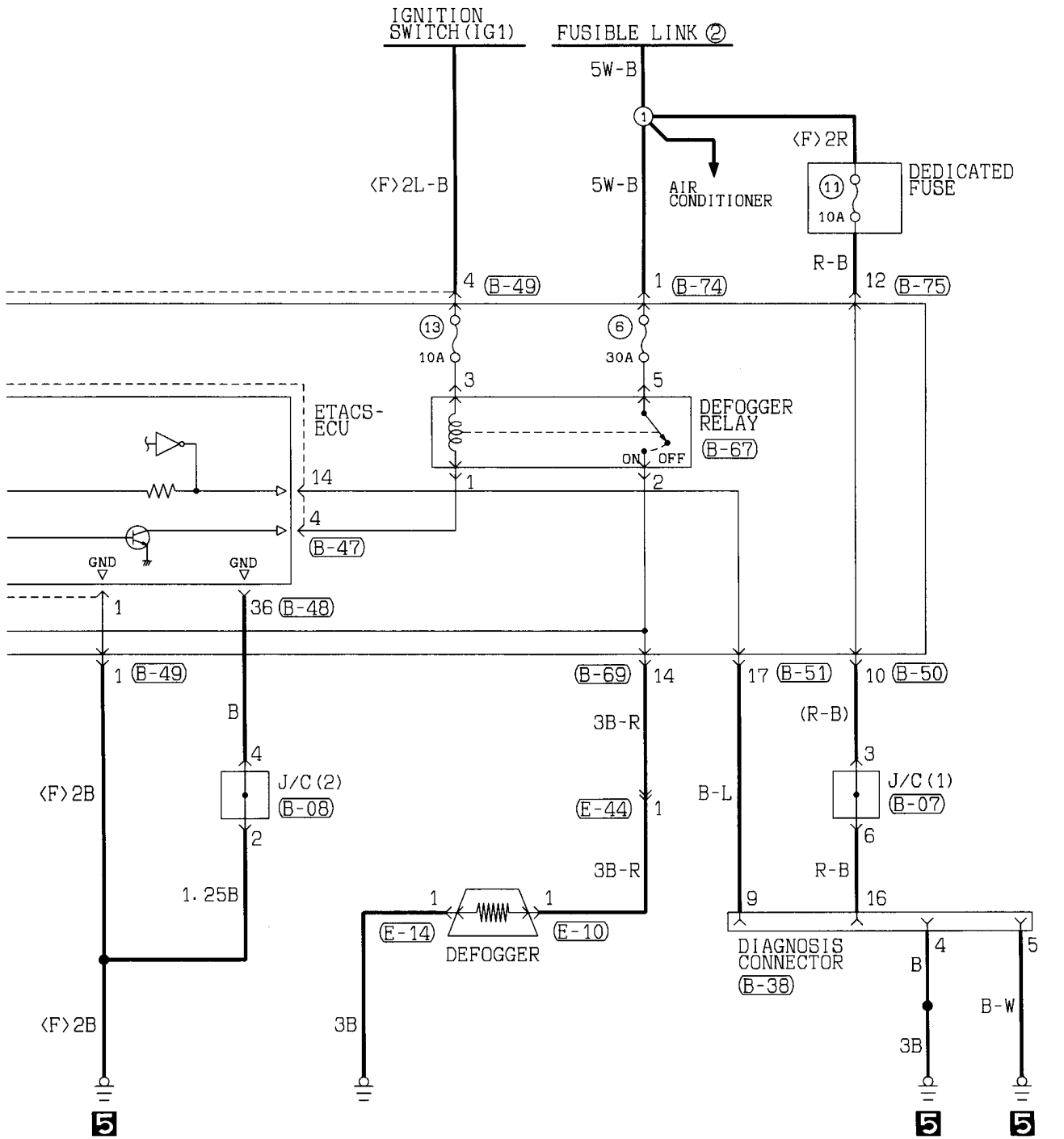

(B-49)

1	2	3	4
5	6	7	8
9	10		

(B-50)

1	2	3	4	5	6	7	8
9	10	11	12	13	14	15	16
17	18	19	20	21	22		

(B-51)

1	2	3	4	5	6	7	8	9
10	11	12	13	14	15	16	17	18
19	20	21	22					

(B-66)

1	2	3	4	5	6	7	8	9	10
11	12	13	14	15	16	17	18	19	20
21	22								

(B-67)

2		
1	4	3
5		

(B-69)

1	2	3	4	5	6	7	8	9
10	11	12	13	14	15	16	17	18
19								

(B-74)

1

Wire colour code

B:Black LG:Light green G:Green L:Blue W:White Y:Yellow SB:Sky blue
 BR:Brown O:Orange GR:Gray R:Red P:Pink V:Violet

HEADLAMP WASHER

90100630073

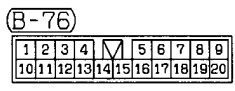
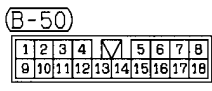
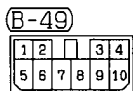
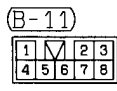
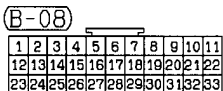
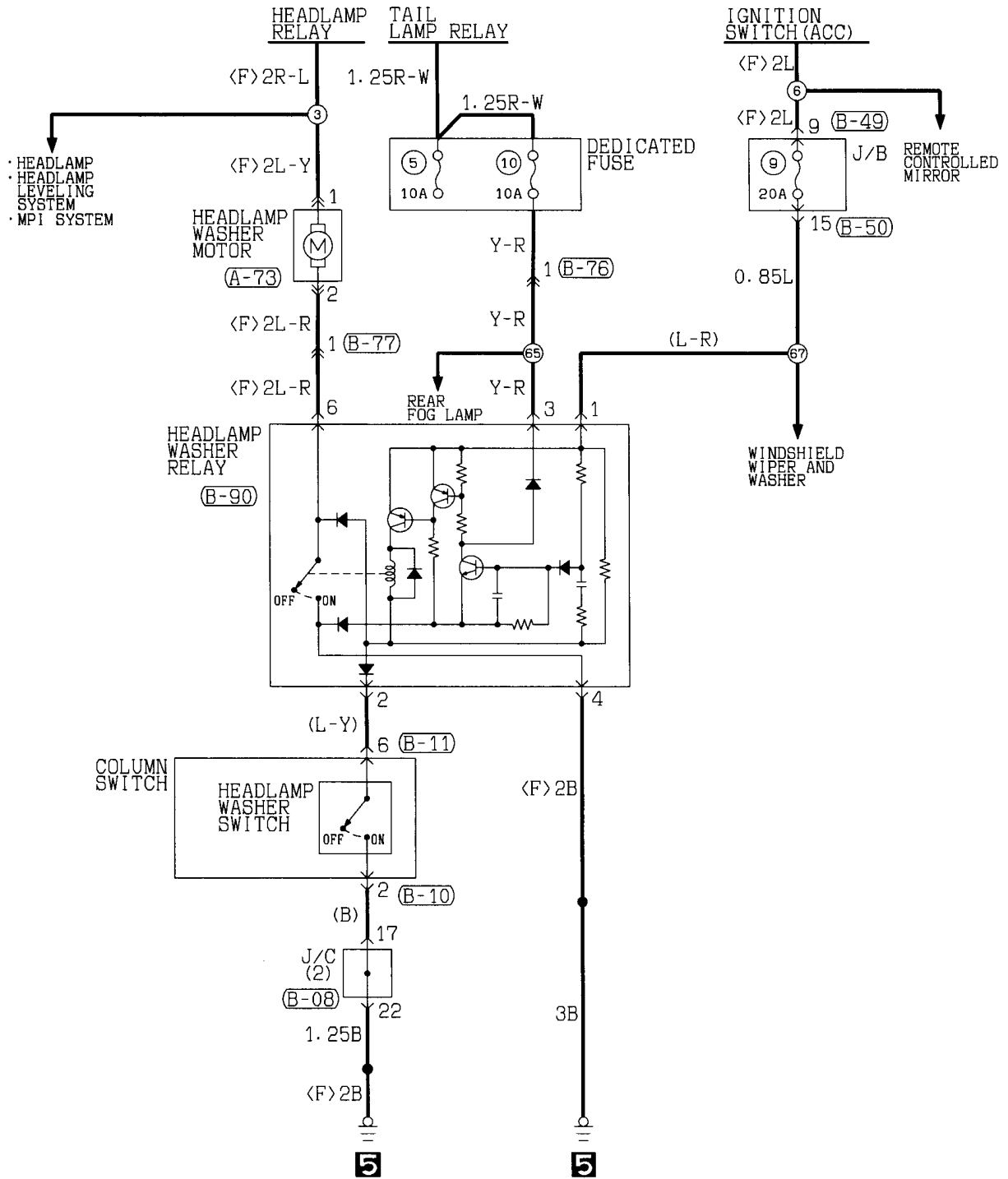

Wire colour code
 B:Black LG:Light green G:Green L:Blue W:White Y:Yellow SB:Sky blue
 BR:Brown O:Orange GR:Gray R:Red P:Pink V:Violet

REMOTE CONTROLLED MIRROR

90100650116

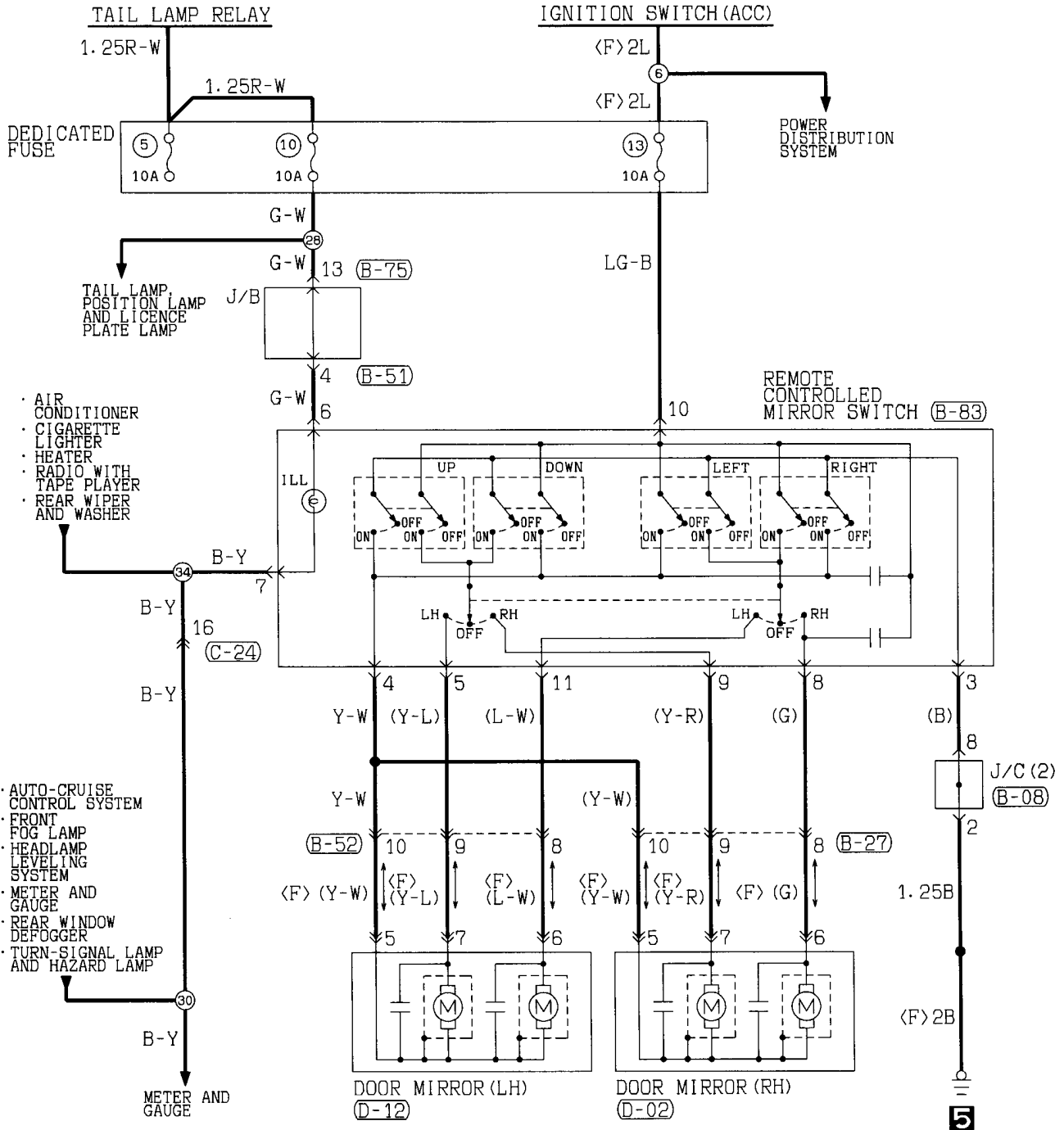

(B-08)



(B-27)



(B-51)

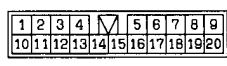

(B-52)



(B-75)



(B-83)

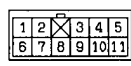

(C-24)

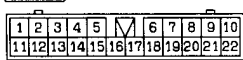

(D-02)



(D-12)



RADIO WITH TAPE PLAYER

90100720299

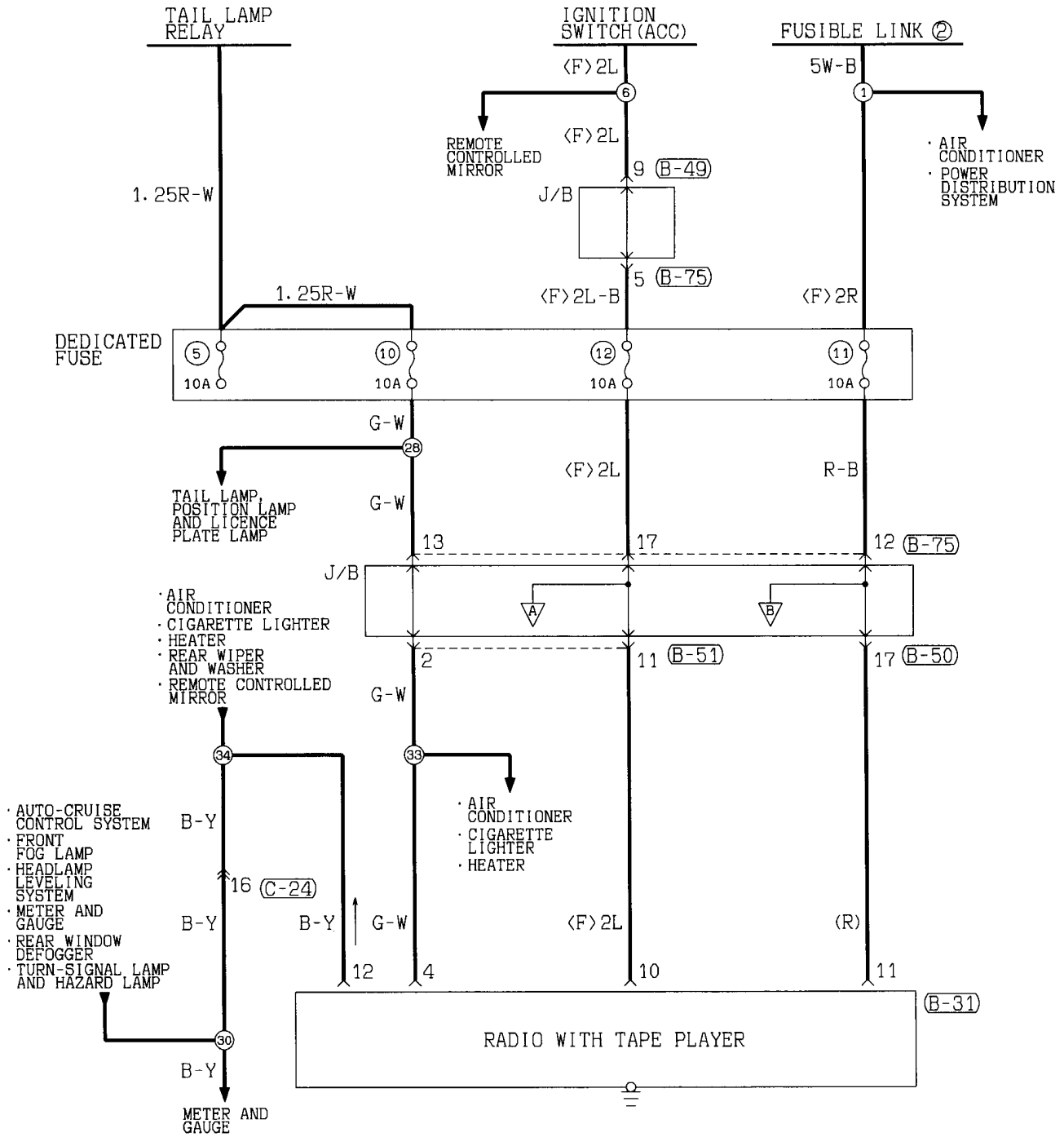

(B-27)

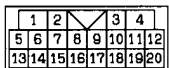

(B-31)

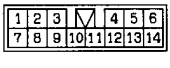

(B-49)

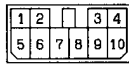

(B-50)

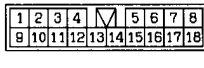

(B-51)

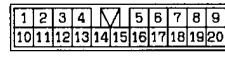

(B-52)

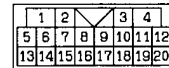

(C-24)

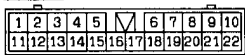

(D-03)



(D-10)



(E-13)



(E-40)



(E-48)



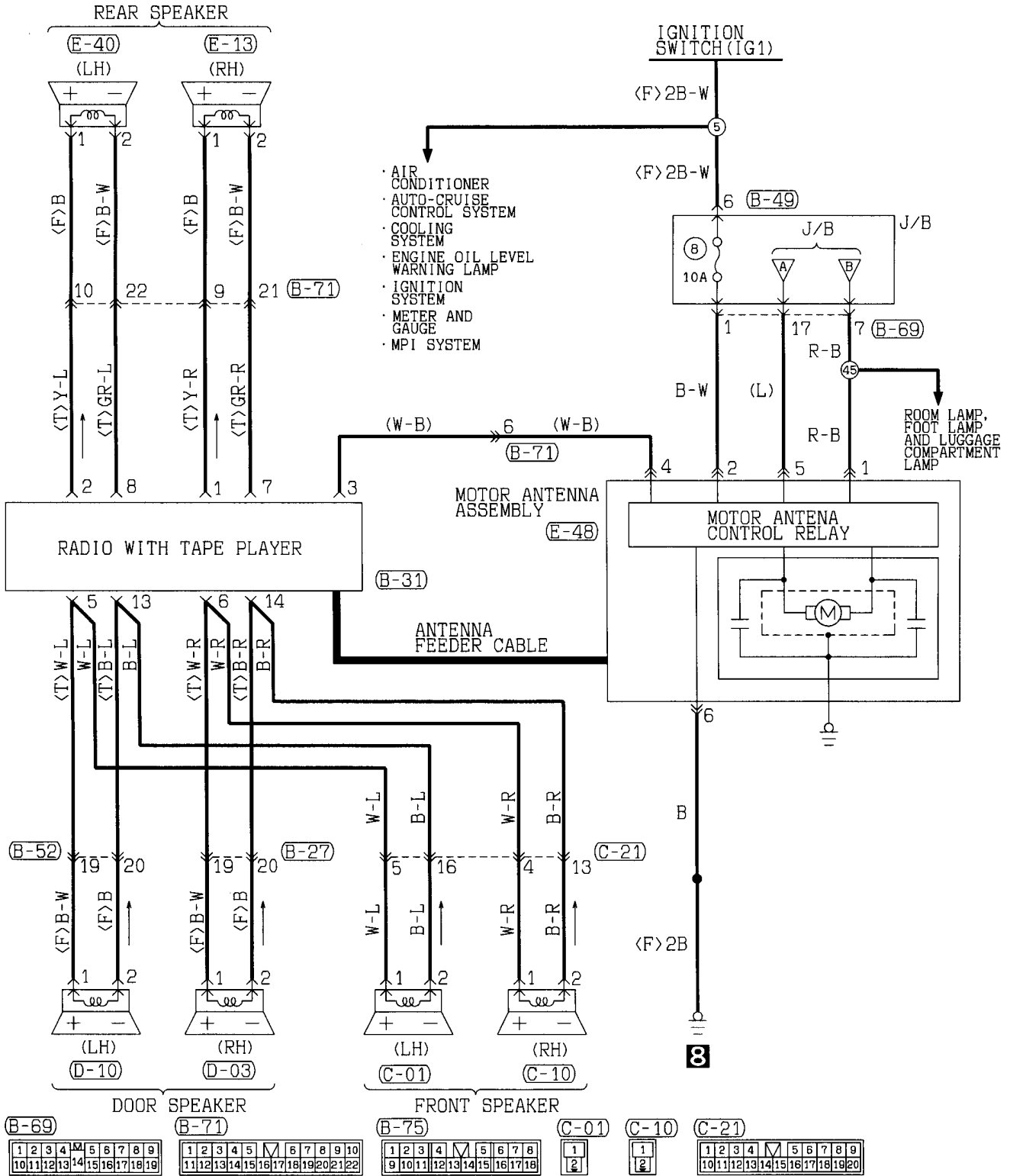

Wire colour code
 B:Black LG:Light green G:Green L:Blue W:White Y:Yellow SB:Sky blue
 BR:Brown O:Orange GR:Gray R:Red P:Pink V:Violet

CIGARETTE LIGHTER

90100780112

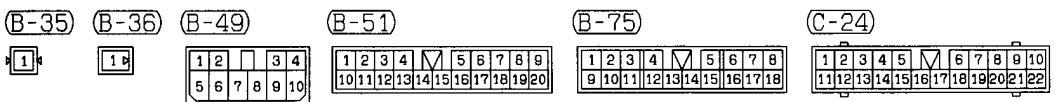
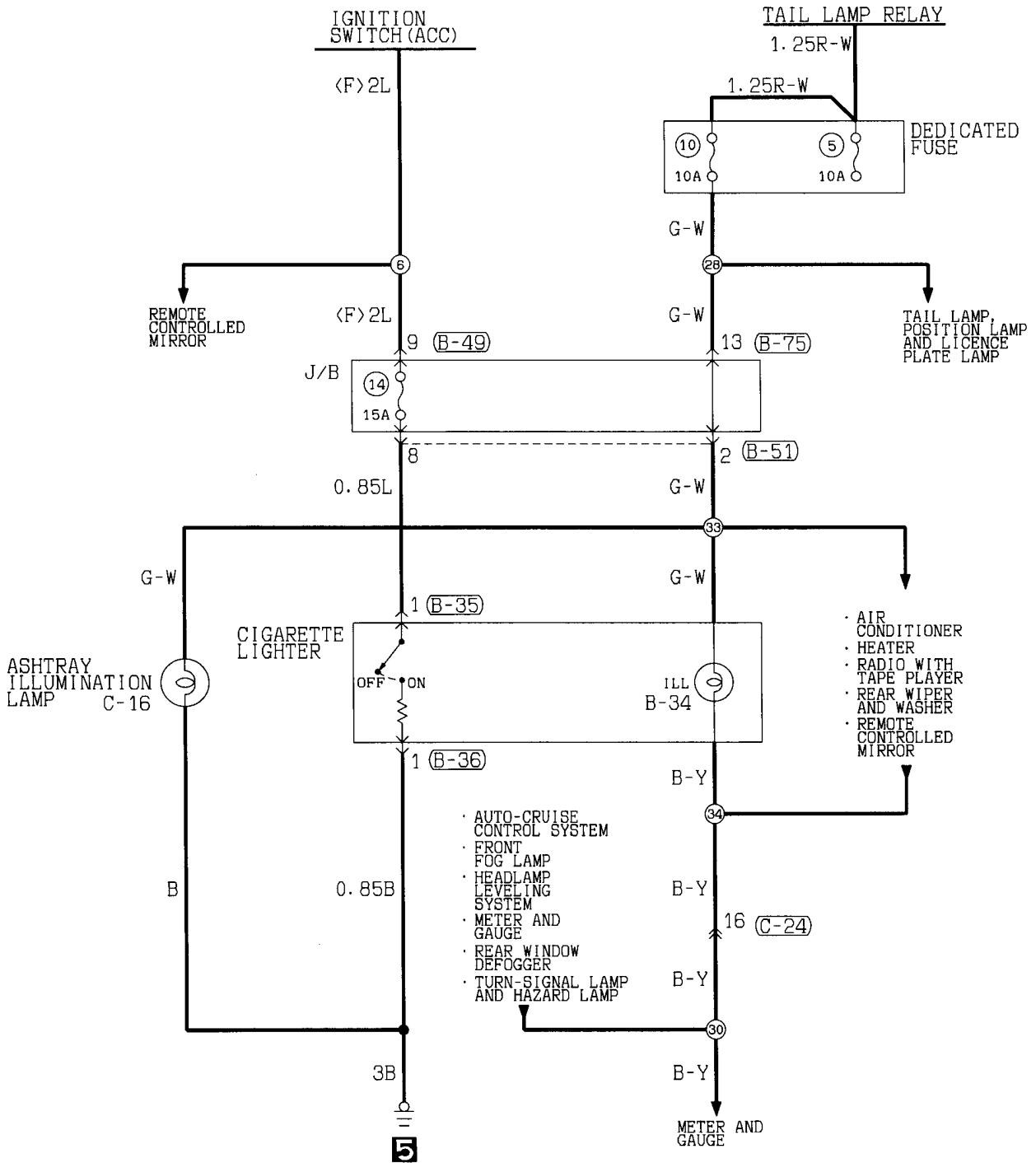

Wire colour code
 B:Black LG:Light green G:Green L:Blue W:White Y:Yellow SB:Sky blue
 BR:Brown O:Orange GR:Gray R:Red P:Pink V:Violet

NOTES

ANTI-SKID BRAKING SYSTEM

90100840261

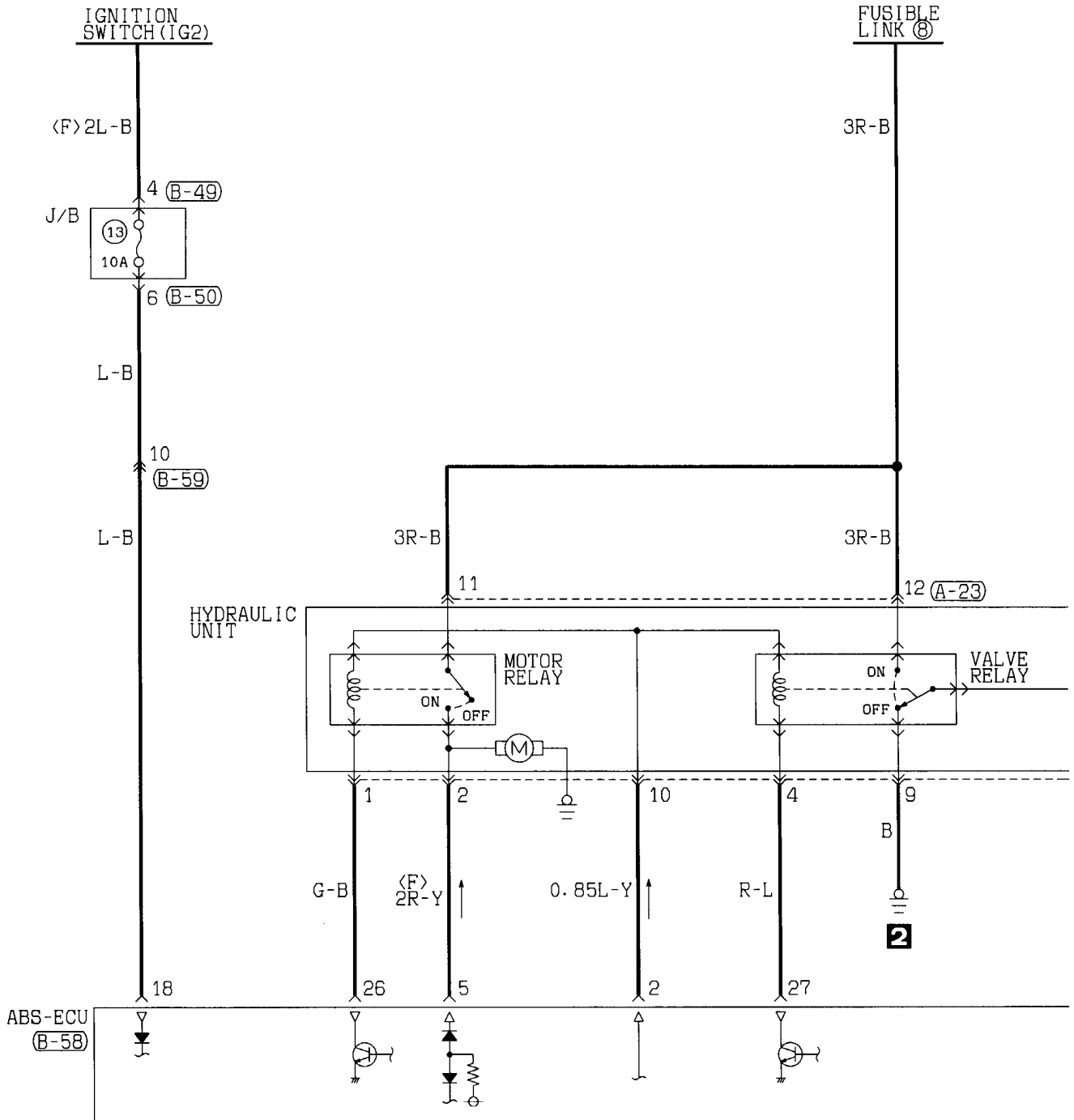

(A-23)

1	2
---	---

(A-24)

0	2	3	4	5
6	7	8	9	10

(B-49)

1	2	3	4
5	6	7	8
9	10		

(B-50)

1	2	3	4	5	6	7	8
9	10	11	12	13	14	15	16
17	18						

(B-58)

1	2	3	4	5	6	7	8	9	10	11	12	13	14	15	16	17	18
19	20	21	22	23	24	25	26	27	28	29	30	31	32	33	34	35	

18	17	16	15	14	13	12	11	10	9	8	7	6	5	4	3	2	1
35	34	33	32	31	30	29	28	27	26	25	24	23	22	21	20	19	

Special tool connector for ABS inspection different from terminal No. inside circuit diagram.

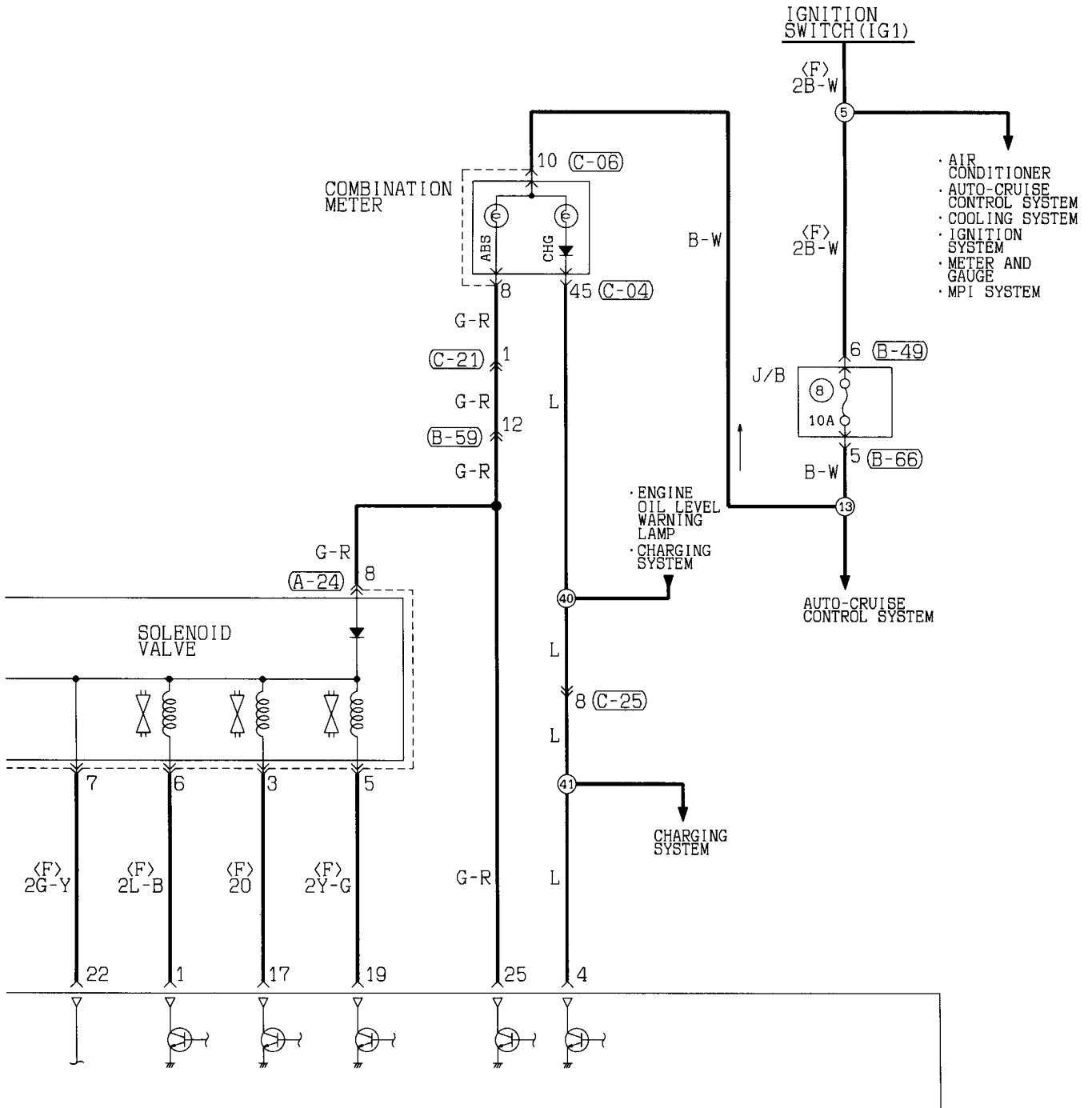

(B-59)

1	2	3	4	5
7	8	9	10	11
12	13	14	15	16

(B-66)

1	2	3	4	5	6	7	8	9	10
11	12	13	14	15	16	17	18	19	20
21	22	23	24	25	26	27	28	29	30

(C-04)

41	42	43	44	45	46	47	48
49	50	51	52	53	54	55	56
57	58	59	60	61	62	63	64

(C-06)

1	2	3	4	5	6	7	8
9	10	11	12	13	14	15	16
17	18	19	20	21	22	23	24

(C-21)

1	2	3	4	5	6	7	8	9
10	11	12	13	14	15	16	17	18
19	20	21	22	23	24	25	26	27

(C-25)

1	2	3
4	5	6
7	8	9

Wire colour code
 B:Black LG:Light green G:Green L:Blue W:White Y:Yellow SB:Sky blue
 BR:Brown O:Orange GR:Gray R:Red P:Pink V:Violet

ANTI-LOCK BRAKING SYSTEM (CONTINUED)

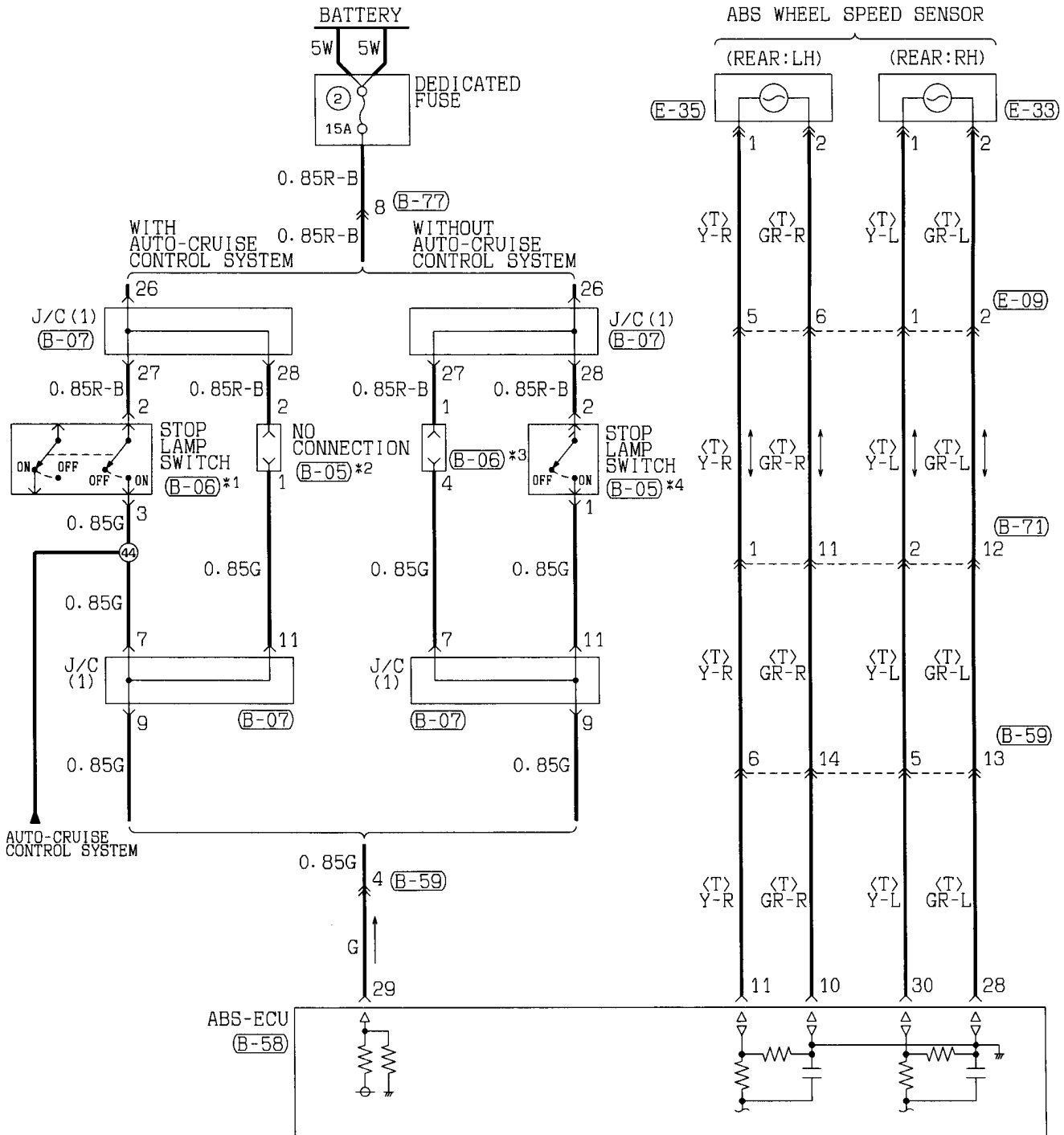

(A-01)	(A-08)	(B-05)	(B-06)	(B-07)	(B-08)	(B-38) FRONT SIDE
(B-77)	(E-09)	(E-33)	(E-35)	Wire colour code		
				B:Black LG:Light green G:Green		
				BR:Brown O:Orange GR:Gray		
				W:White SB:Sky blue P:Pink		
				V:Violet		
				L:Blue		
				R:Red		
				Y:Yellow		

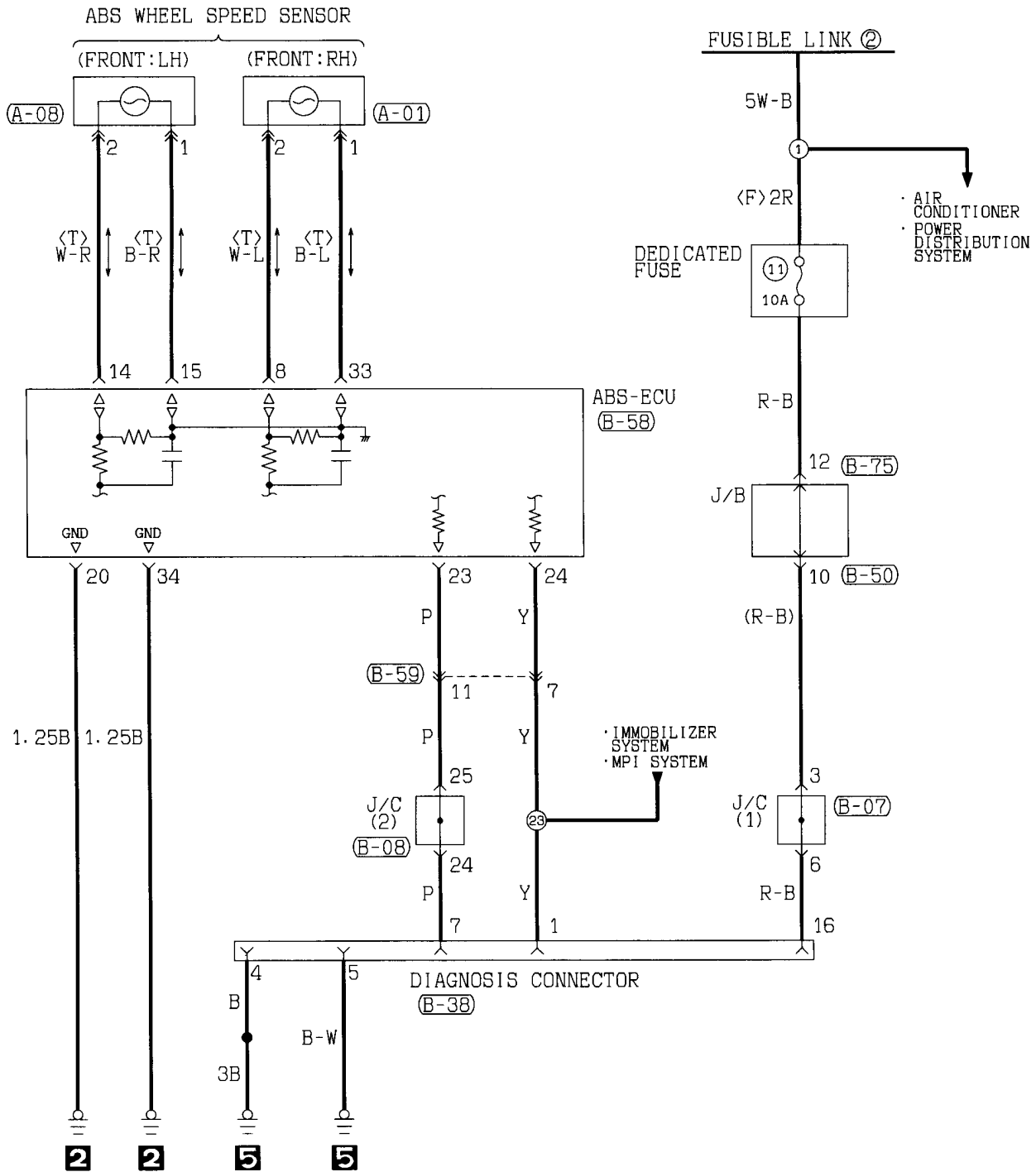

(B-50)

1	2	3	4	5	6	7	8
9	10	11	12	13	14	15	16
17	18						

(B-58)

1	2	3	4	5	6	7	8	9	10	11	12	13	14	15	16	17	18
19	20	21	22	23	24	25	26	27	28	29	30	31	32	33	34	35	

(B-59)

1	2	3	4	5	6
7	8	9	10	11	12

(B-71)

1	2	3	4	5	6	7	8	9	10
11	12	13	14	15	16	17	18	19	20
21	22								

(B-75)

1	2	3	4	5	6	7	8
9	10	11	12	13	14	15	16
17	18						

18	17	16	15	14	13	12	11	10	9	8	7	6	5	4	3	2	1
35	34	33	32	31	30	29	28	27	26	25	24	23	22	21	20	19	

Special tool connector for ABS inspection different from terminal No. inside circuit diagram.

AUTO-CRUISE CONTROL SYSTEM

90100930180

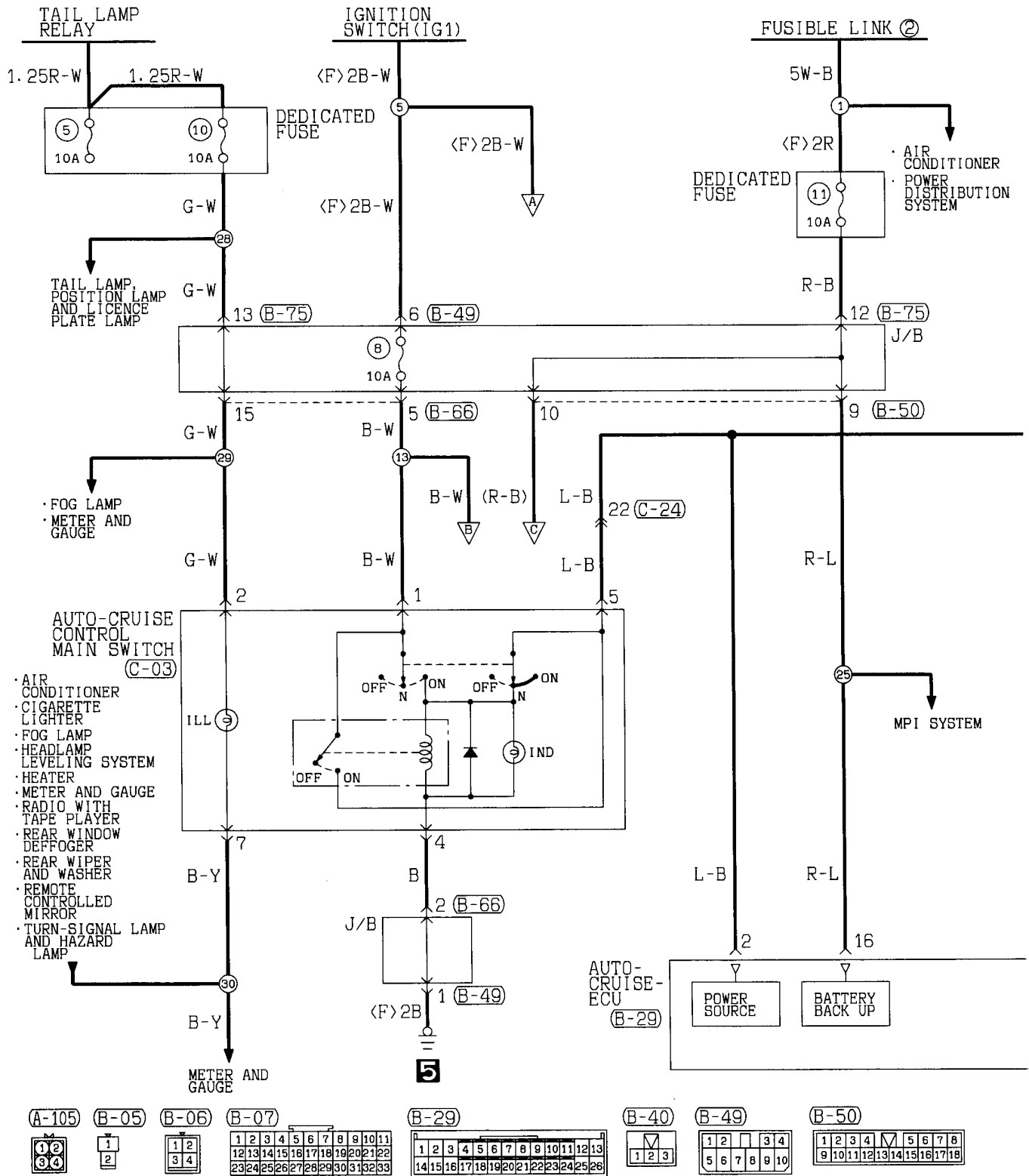

Wire colour code
 B:Black LG:Light green G:Green L:Blue W:White Y:Yellow SB:Sky blue
 BR:Brown O:Orange GR:Gray R:Red P:Pink V:Violet

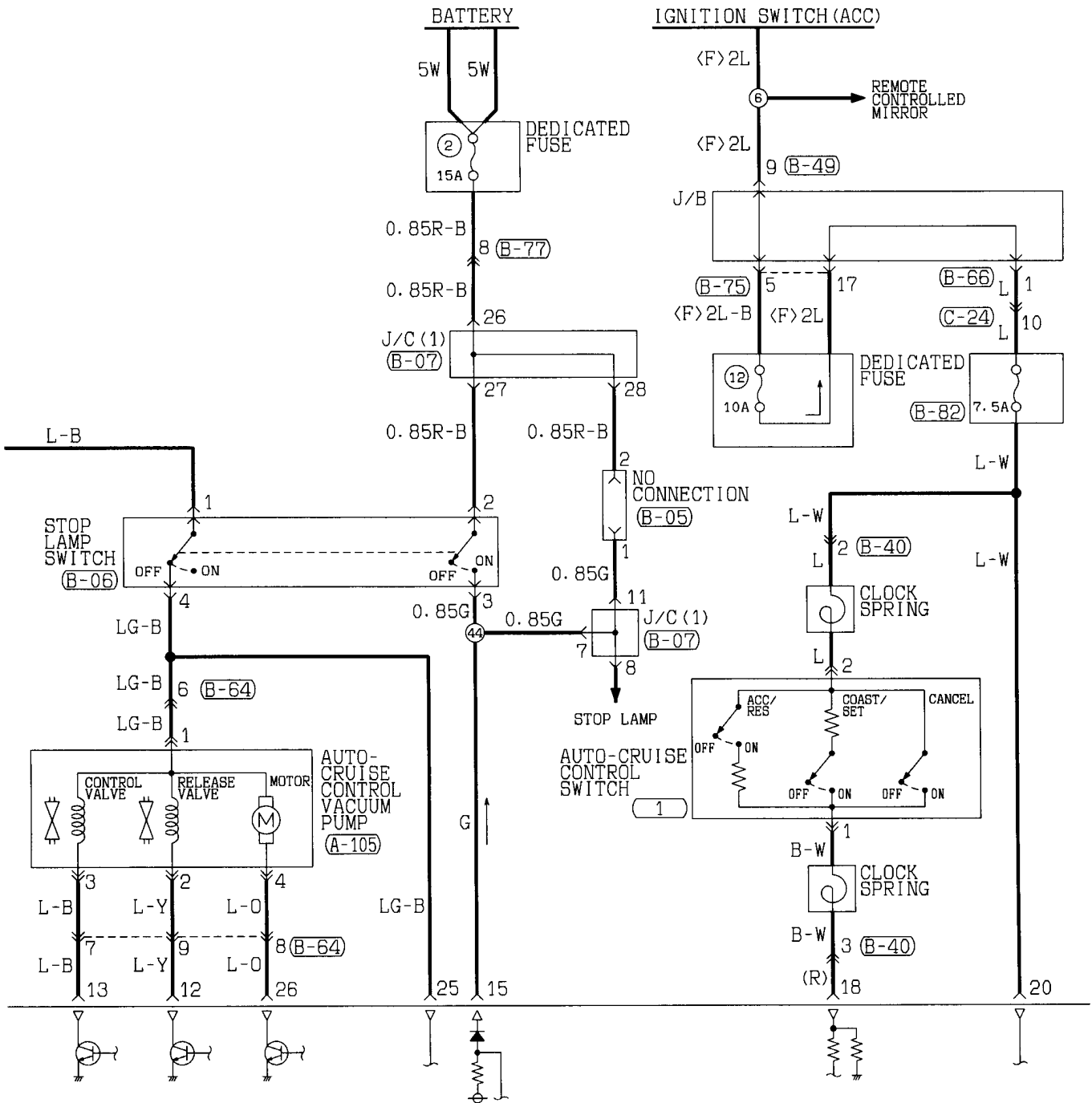

(B-64)

1	2	M	3	4
5	6	7	8	9

(B-66)

1	2	3	4	5	M	6	7	8	9	10
11	12	13	14	15	16	17	18	19	20	21

(B-75)

1	2	3	4	M	5	6	7	8
9	10	11	12	13	14	15	16	17

(B-77)

1	2	3
4	5	6

(C-03)

1	M	2	3
4	5	6	7

(C-24)

1	2	3	4	5	M	6	7	8	9	10
11	12	13	14	15	16	17	18	19	20	21

(1)

L	X
1	2

AUTO-CRUISE CONTROL SYSTEM (CONTINUED)

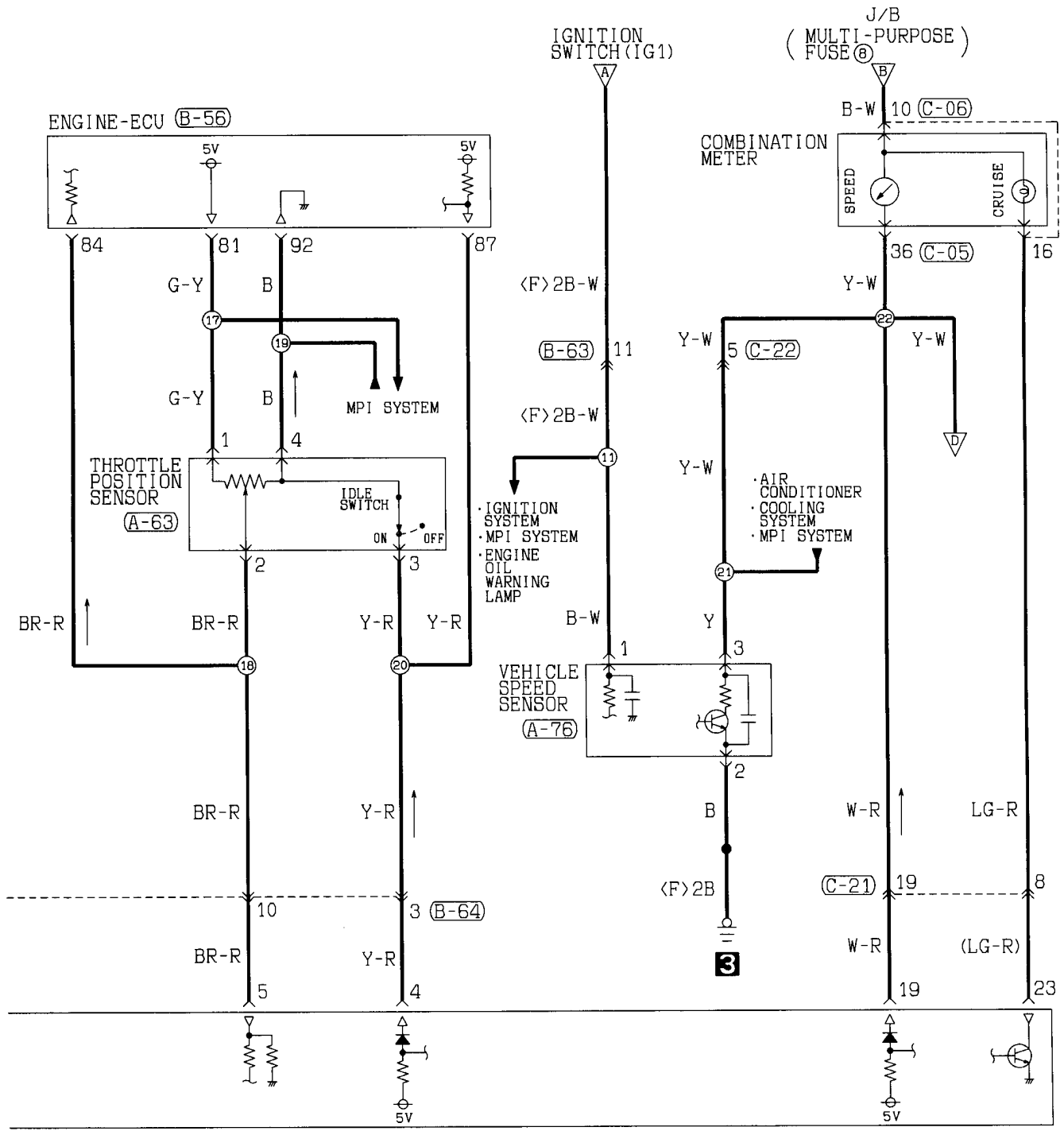

AUTO-CRUISE-ECU (B-29)

(A-63)



(A-76)



(B-04)



(B-07)



(B-08)



(B-29)



(B-38) FRONT SIDE

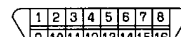

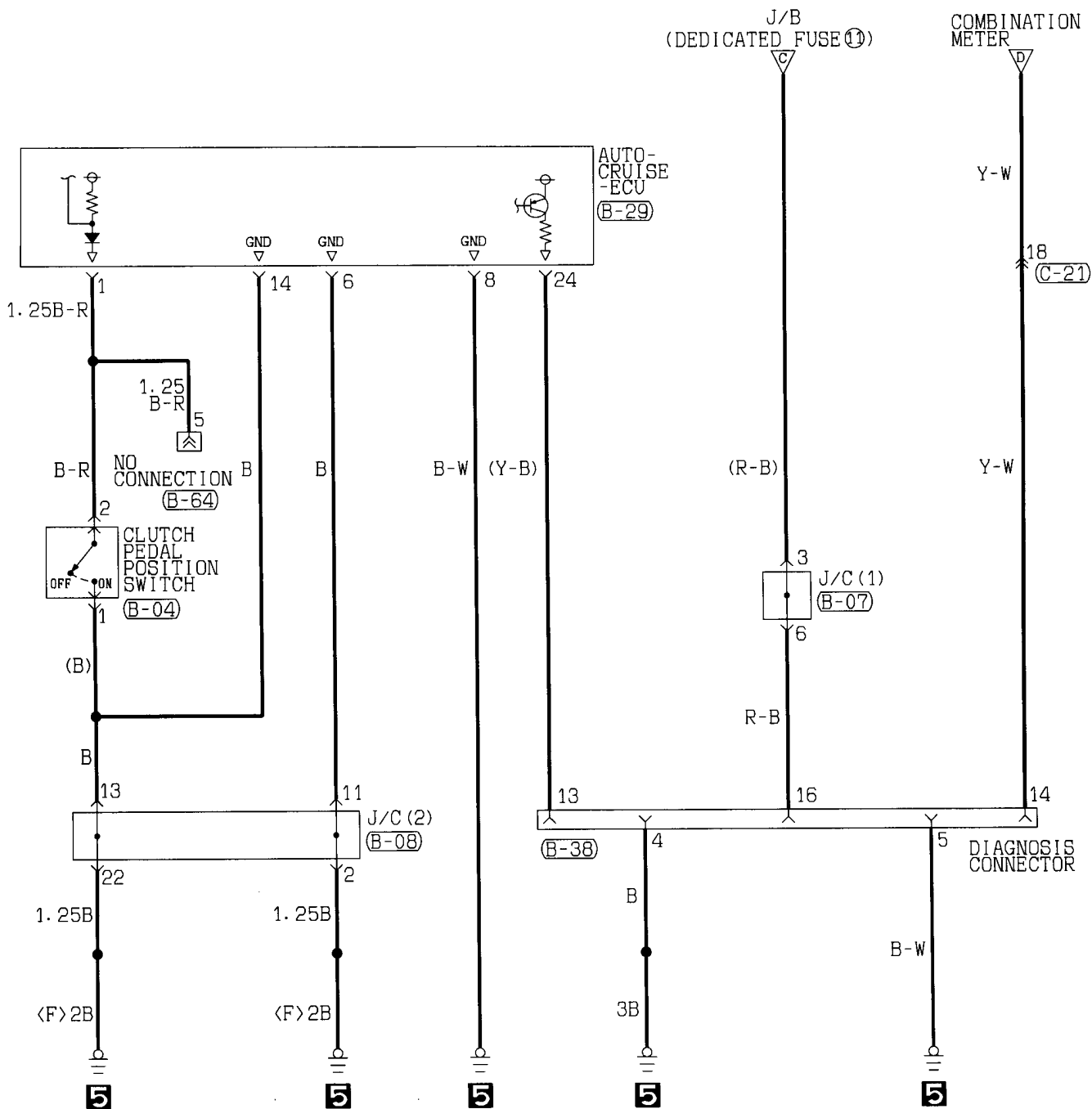

(B-56)

1	2	3	4	5	6	7	8	9	10
11	12	13	14	15	16	17	18	19	20
21	22	23	24	25	26	27	28	29	30
31	32	33	34	35	36	37			

(B-63)

1	2	3	4	5	M	6	7	8	9	10	
11	12	13	14	15	16	17	18	19	20	21	22

(B-64)

1	2	M	3	4
5	6	7	8	10

(C-05)

21	22	23	24	25	26	27	28
29							
30	31	32	33	34	35	36	37

(C-06)

1	2	3	4	5	6	7	8
9							
10	11	12	13	14	15	16	17

(C-21)

1	2	3	4	M	5	6	7	8	9	
10	11	12	13	14	15	16	17	18	19	20

Wire colour code

B:Black LG:Light green G:Green L:Blue W:White Y:Yellow SB:Sky blue
 BR:Brown O:Orange GR:Gray R:Red P:Pink V:Violet

SUPPLEMENTAL RESTRAINT SYSTEM (SRS)

90100970182

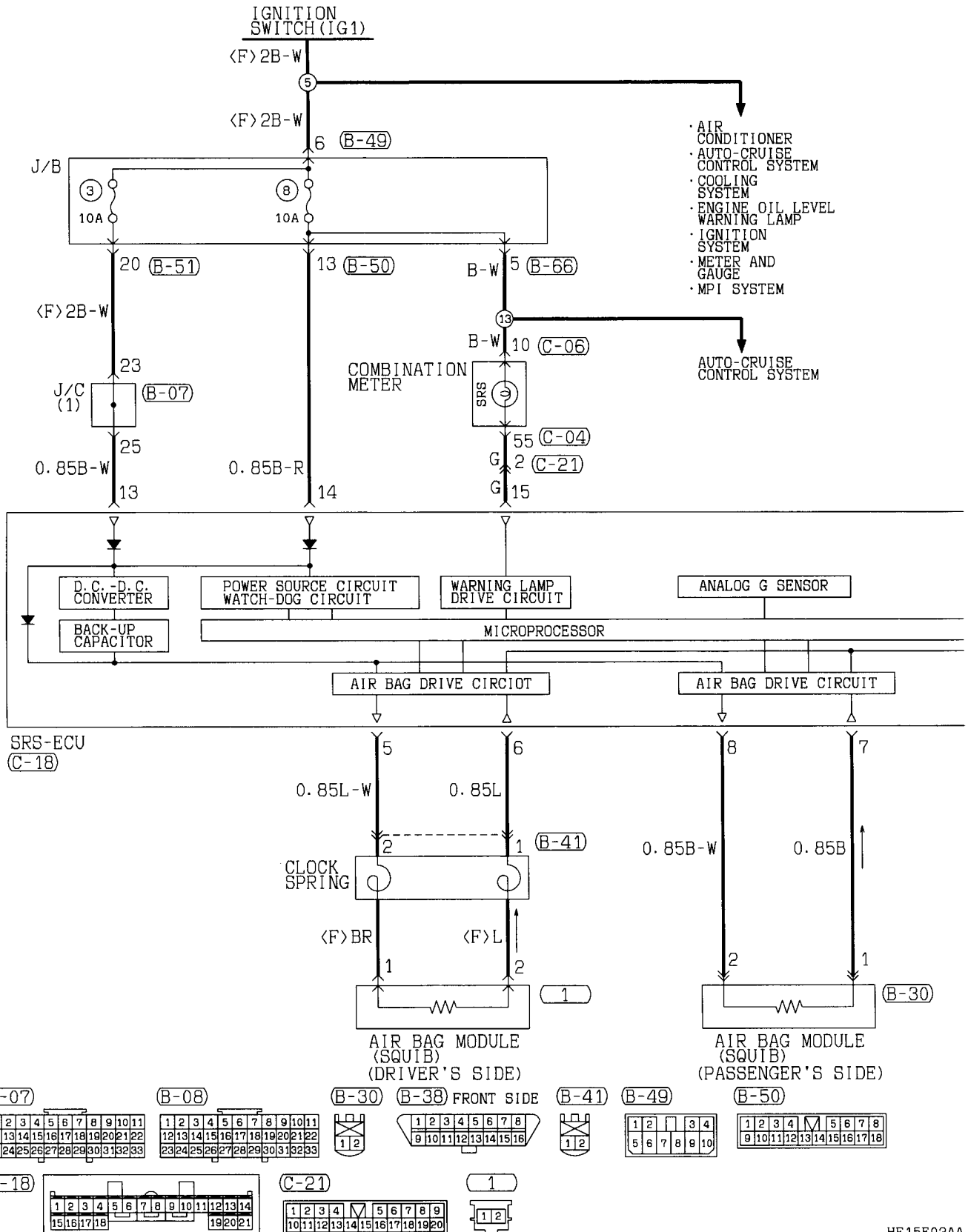

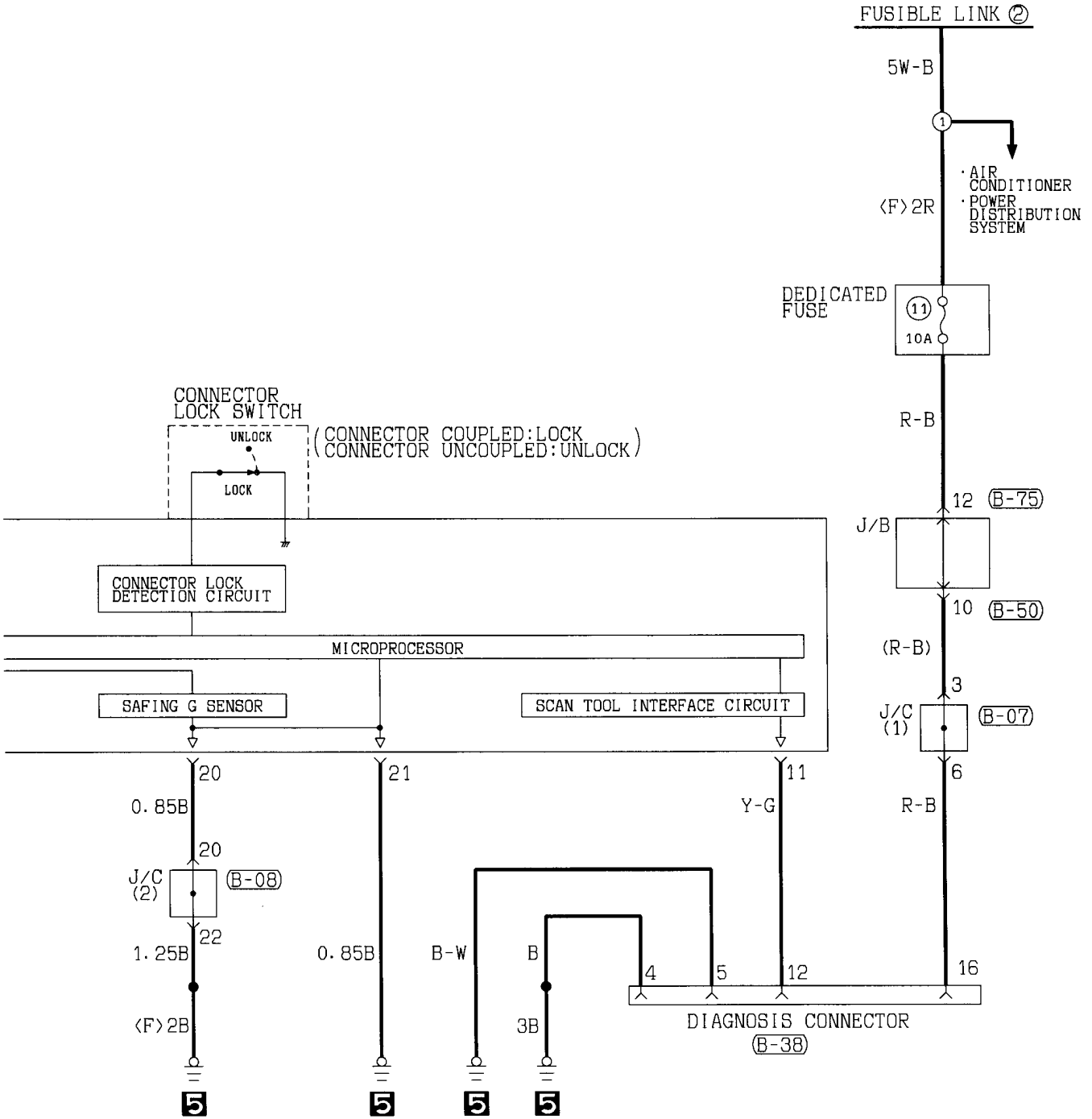

(B-51)

1	2	3	4	M	5	6	7	8	9	
10	11	12	13	14	15	16	17	18	19	20

(B-66)

1	2	3	4	5	M	6	7	8	9	10	
11	12	13	14	15	16	17	18	19	20	21	22

(B-75)

1	2	3	4	M	5	6	7	8	
9	10	11	12	13	14	15	16	17	18

(C-04)

41	42	43	44	45	46	47	48
			49				
50	51	52	53	54	55	56	57

(C-06)

1	2	3	4	5	6	7	8
			9				
10	11	12	13	14	15	16	17

Wire colour code

B:Black LG:Light green G:Green L:Blue W:White Y:Yellow SB:Sky blue
 BR:Brown O:Orange GR:Gray R:Red P:Pink V:Violet

IMMOBILIZER SYSTEM

90101360025

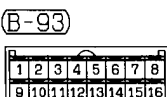
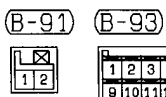
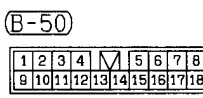
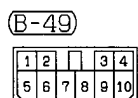
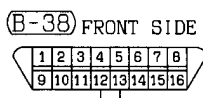
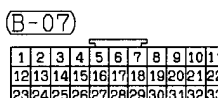
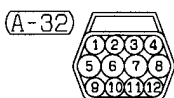
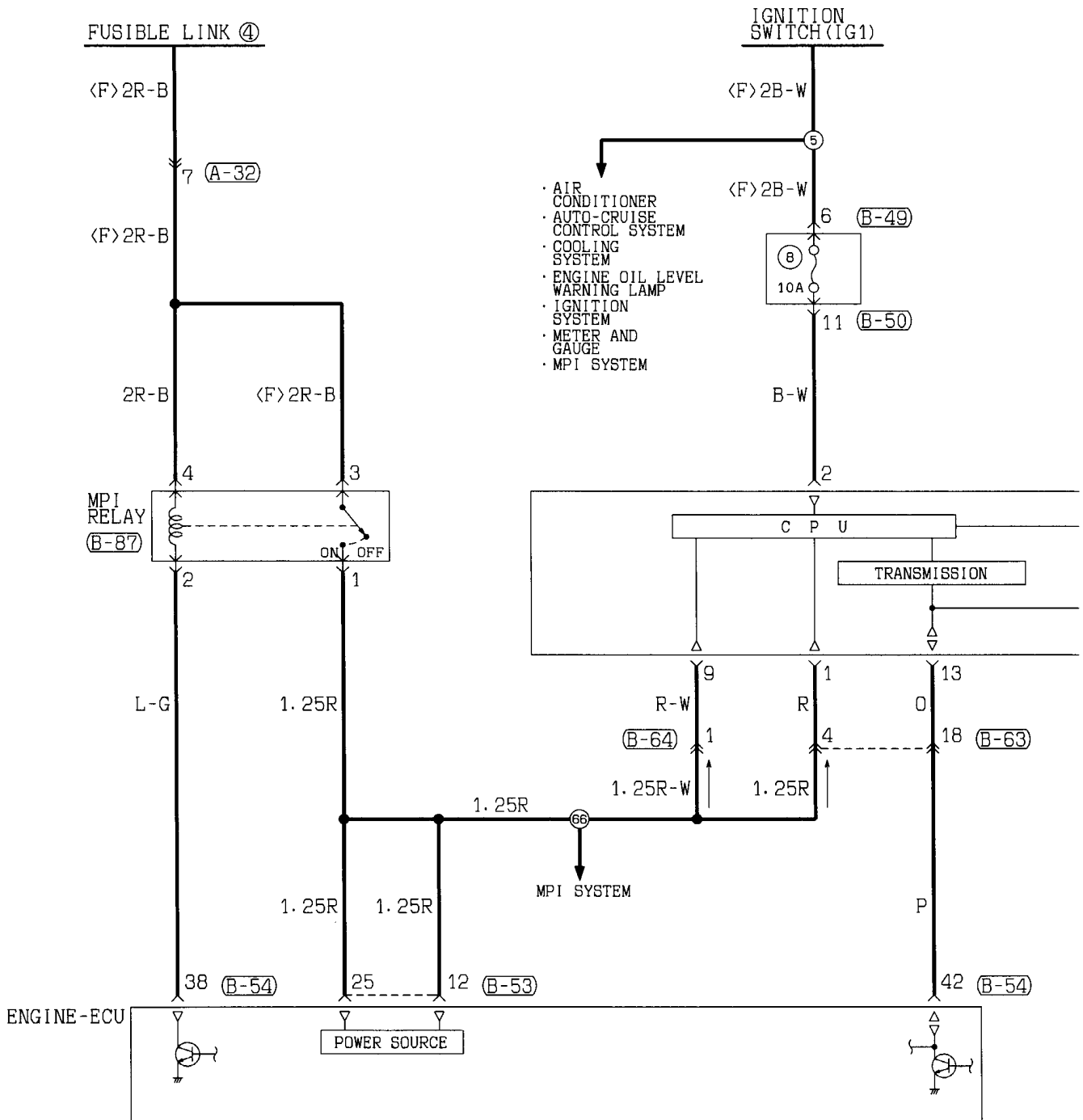

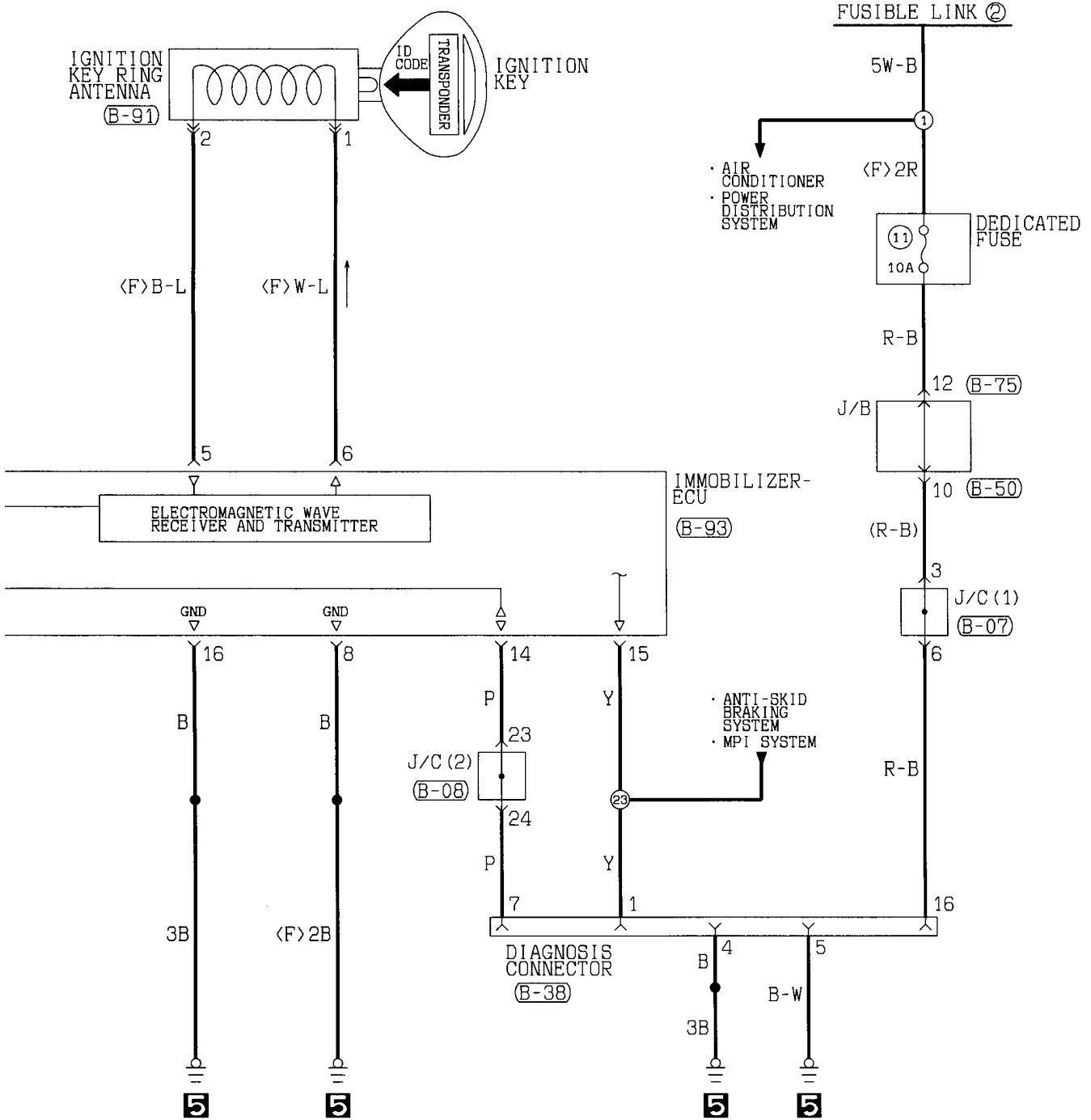

(B-53)

1	2	3	4	5	6	7	8	9	10	11	12	13
14	15	16	17	18	19	20	21	22	23	24	25	26

(B-54)

31	32	33	34	35	36	37	38
39	40	41	42	43	44	45	46

(B-63)

1	2	3	4	5	6	7	8	9	10
11	12	13	14	15	16	17	18	19	20
21	22								

(B-64)

1	2	3	4
5	6	7	8
9	10		

(B-75)

1	2	3	4	5	6	7	8
9	10	11	12	13	14	15	16
17	18						

(B-87)

1	2
3	4

Wire colour code
 B:Black LG:Light green G:Green L:Blue W:White Y:Yellow SB:Sky blue
 BR:Brown O:Orange GR:Gray R:Red P:Pink V:Violet

POWER SEAT

90101040080

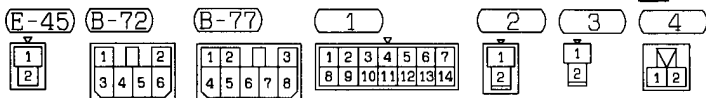
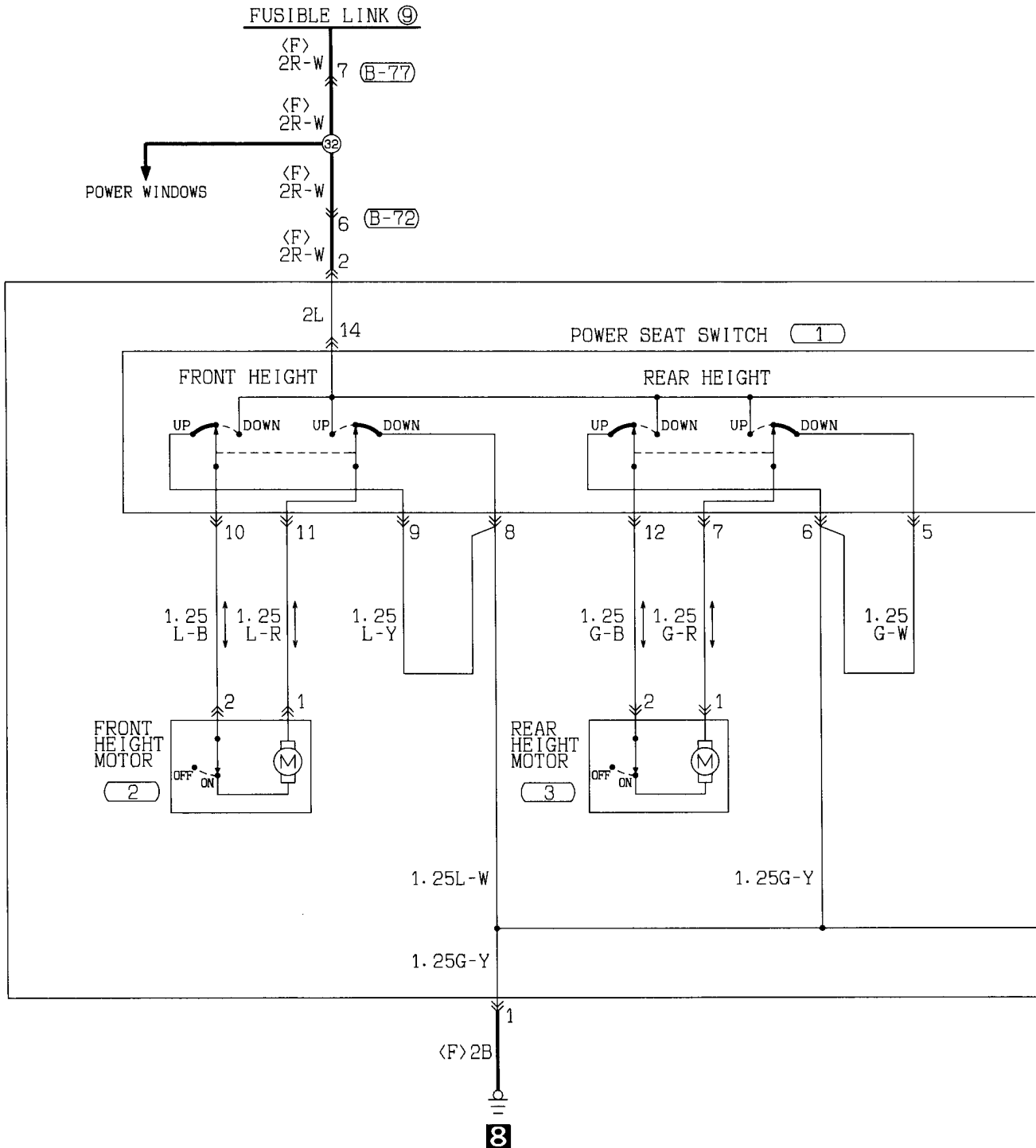

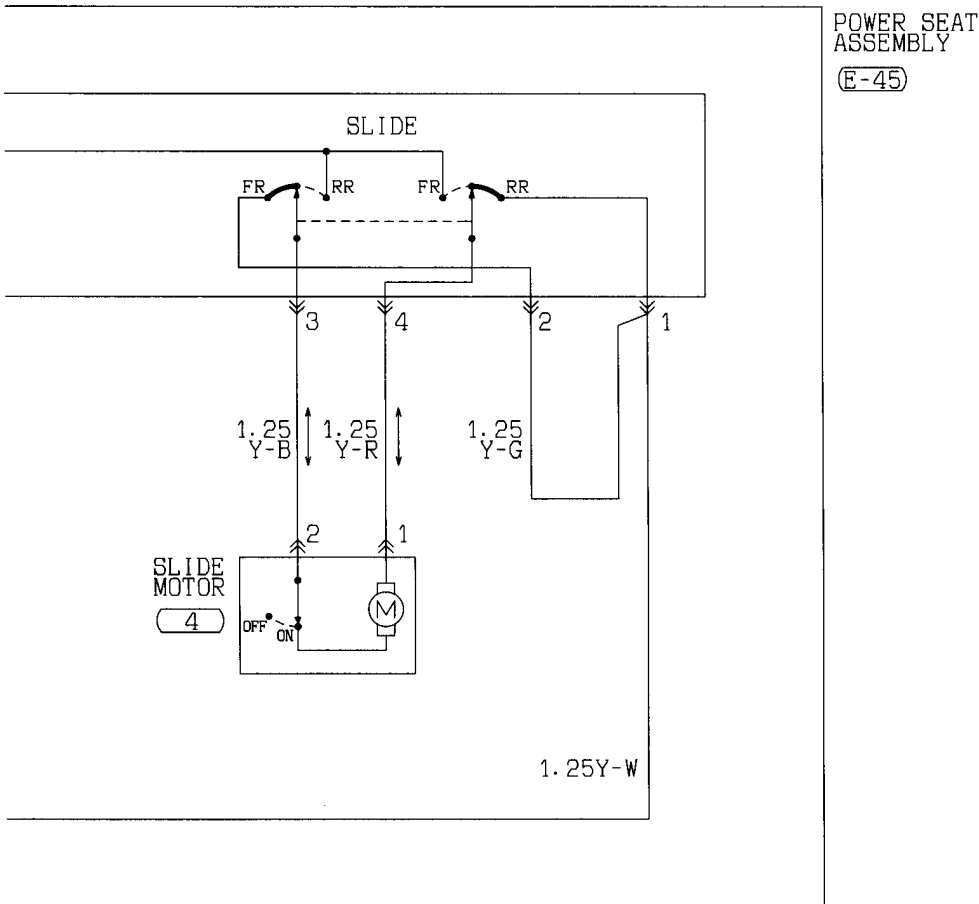

Wire colour code
 B:Black LG:Light green G:Green L:Blue W:White Y:Yellow SB:Sky blue
 BR:Brown O:Orange GR:Gray R:Red P:Pink V:Violet

LIGHTING MONITOR BUZZER

90101140131

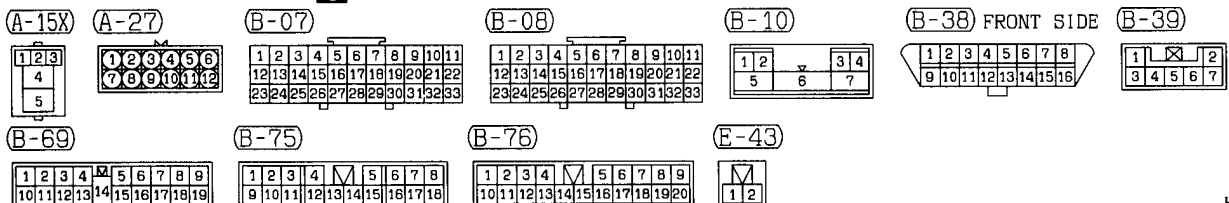
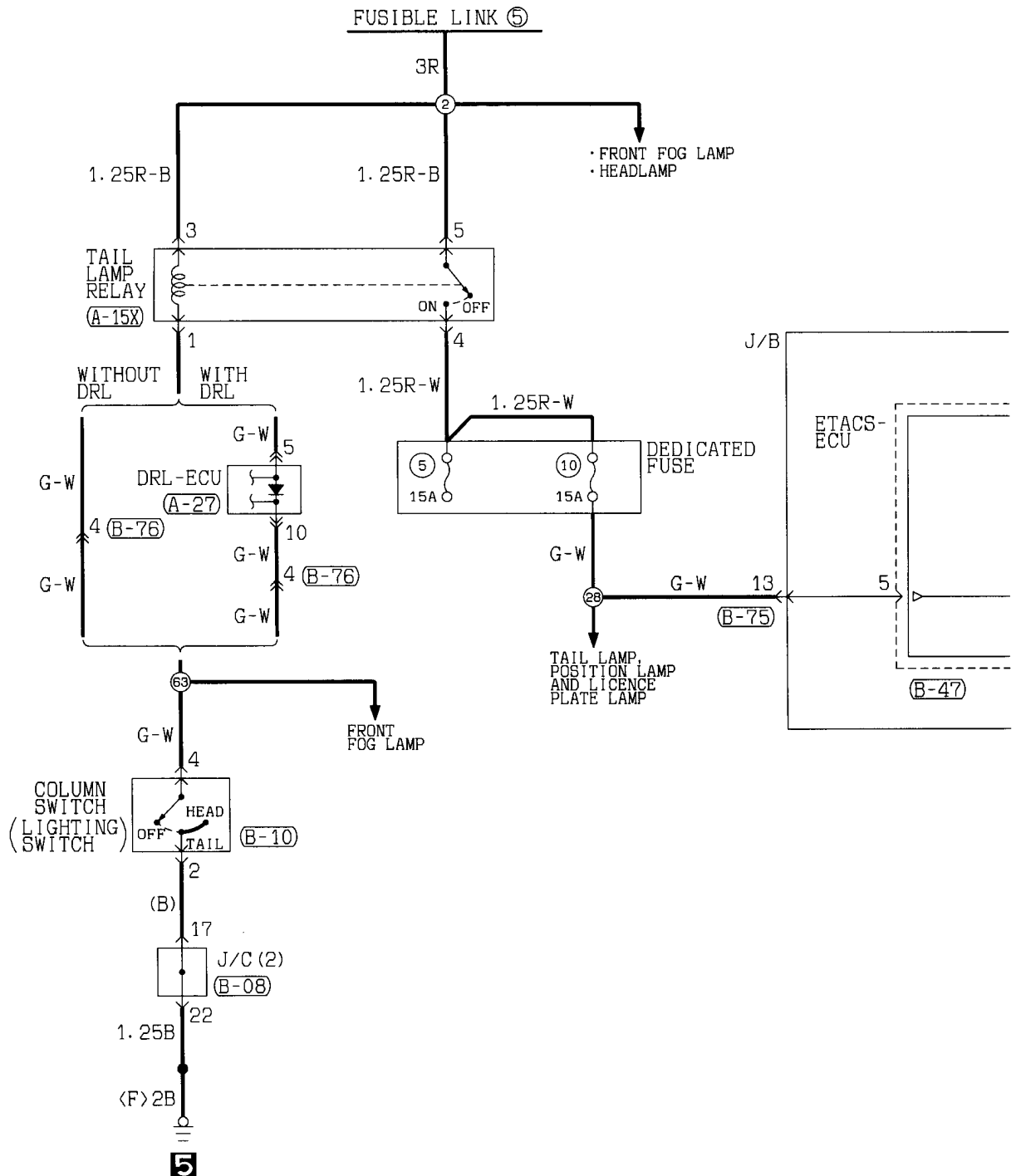

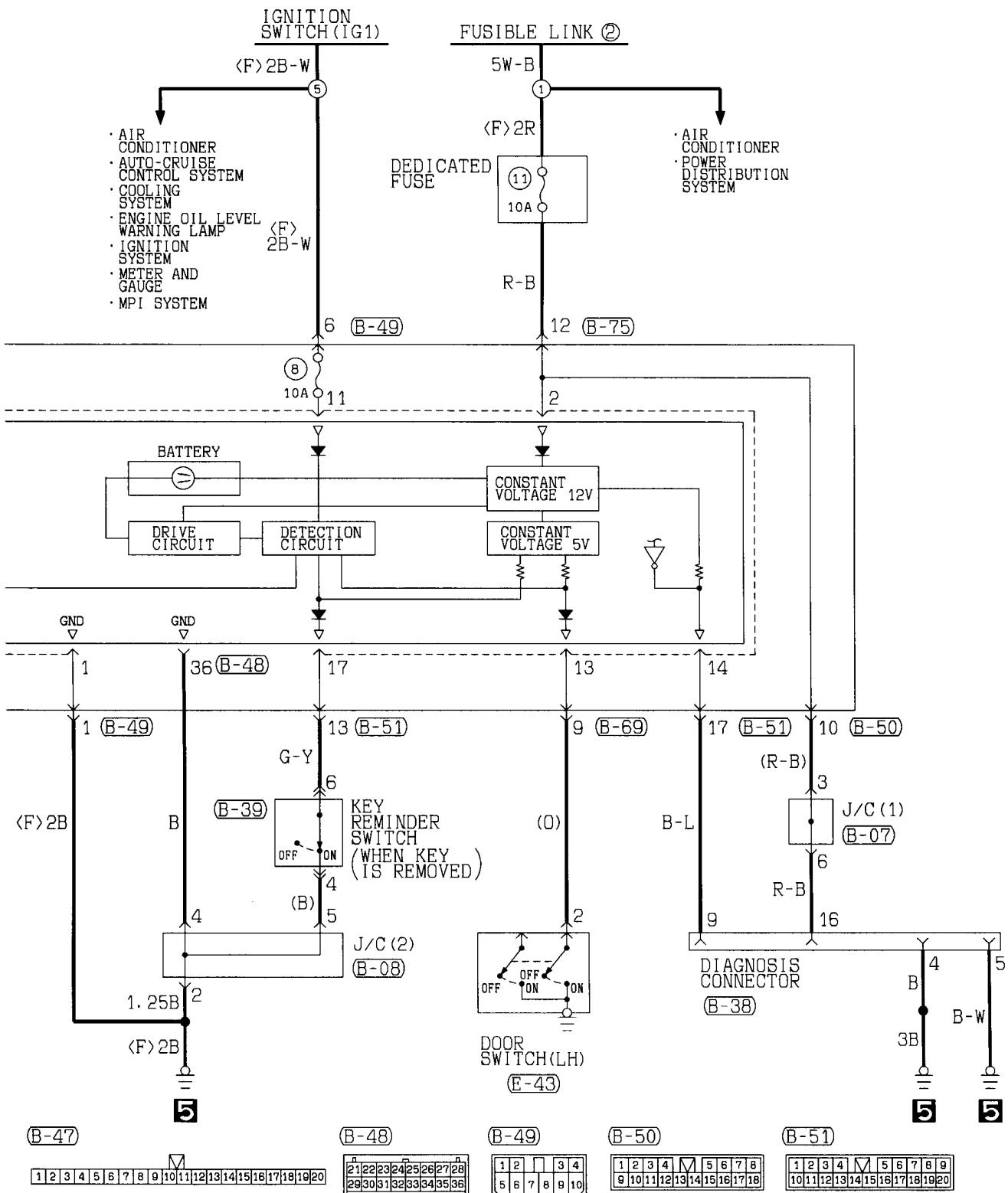

Wire colour code
 B:Black LG:Light green G:Green L:Blue W:White Y:Yellow SB:Sky blue
 BR:Brown O:Orange GR:Gray R:Red P:Pink V:Violet

SUNROOF

90100990096

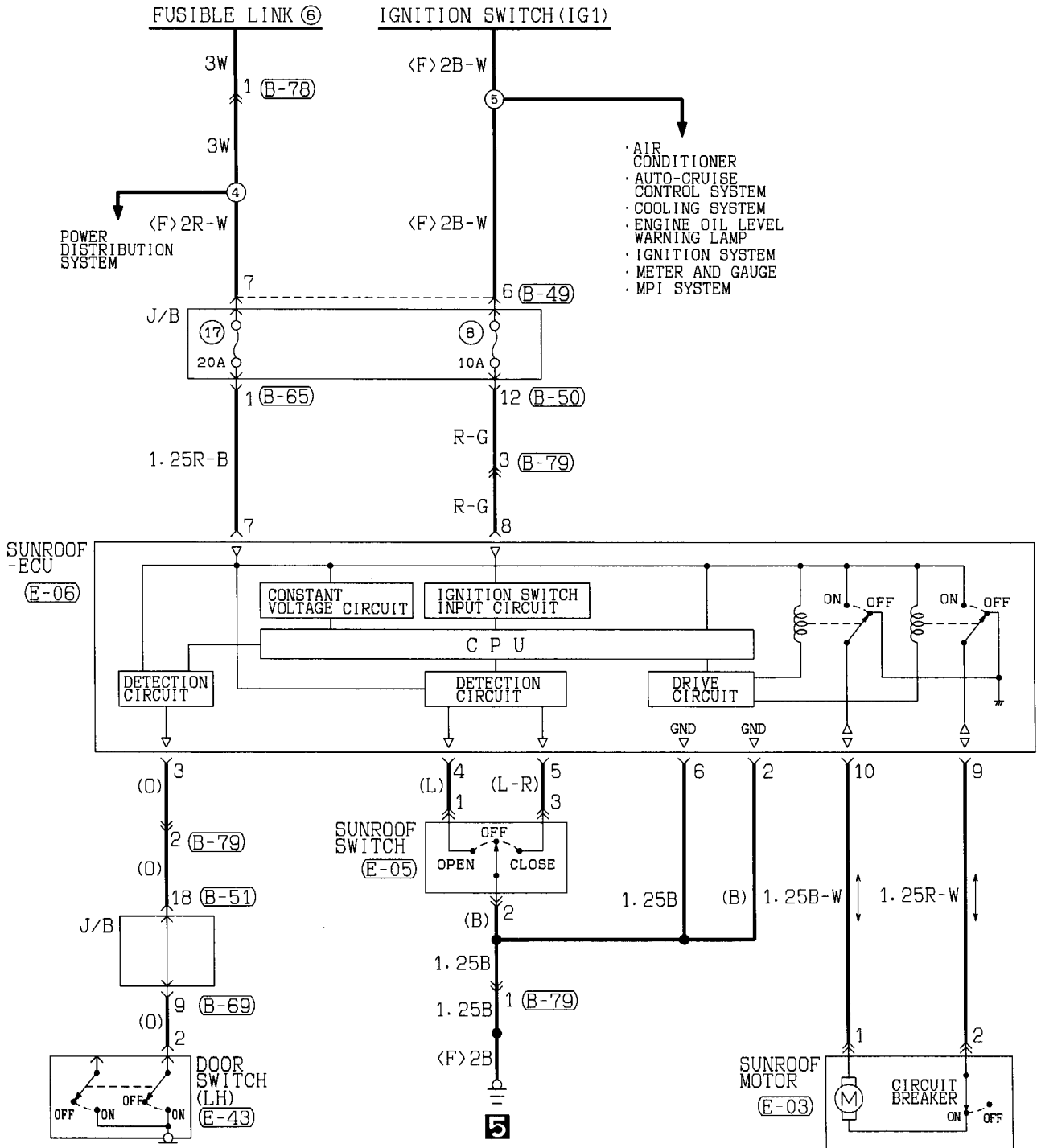

(B-49)

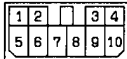

(B-50)

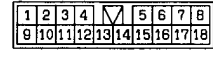

(B-51)

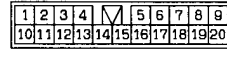

(B-65)

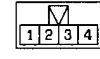

(B-69)

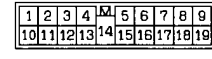

(B-78)



(B-79)



(E-03)



(E-05)



(E-06)

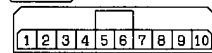

(E-43)



INDEX (In order of connector No.)

90100230013

	Connector No.	Parts name	Circuit diagram page	Wiring diagram page
A	A-01	ABS wheel-speed sensor (front: RH)	4-97	2-4
	A-02	Alternator	4-18	2-4
	A-03	Alternator	4-18	2-4
	A-04	Crankshaft position sensor	4-24	2-4
	A-05	Detonation sensor	4-26	2-4
	A-08	ABS wheel-speed sensor (front: LH)	4-97	2-4
	A-09X	Condenser fan relay (LO)	4-9, 29, 79	2-4
	A-10X	Condenser fan relay (HI)	4-9, 29, 79	2-4
	A-11X	Radiator fan relay (LO)	4-9, 28, 78	2-4
	A-13X	Radiator fan relay (HI)	4-9, 29, 79	2-4
	A-14X	Headlamp relay	4-9, 11, 30, 34	2-4
	A-15X	Tail lamp relay	4-9, 11, 40, 44, 46, 108	2-4
	A-16X	Front fog lamp relay	4-9, 44	2-4
	A-17X	Horn relay	4-9, 61	2-4
	A-18X	A/C compressor clutch relay	4-9, 23, 77	2-4
	A-20	Front combination lamp (LH)	4-56	2-4
	A-23	Hydraulic unit	4-94	2-4
	A-24	Hydraulic unit	4-95	2-4
	A-25	Headlamp assembly (LH)	4-30, 34, 38, 40	2-4
	A-26	Front wiring harness and joint wiring harness combination	4-62	2-4
	A-27	DRL-ECU	4-35, 40, 44, 46, 47, 108	2-5
	A-28	Horn (LH)	4-61	2-5
	A-30	Front fog lamp (LH)	4-44	2-5
	A-31	Oil pressure switch	4-66	2-5
	A-32	Front wiring harness and control wiring harness combination	4-20, 23, 26, 28, 29, 67, 77, 78, 79, 104	2-5
	A-33	Radiator fan motor	4-29, 79	2-5
	A-34	Control wiring harness and battery cable combination	4-16	2-5
	A-35	Starter motor	4-16	2-5
	A-36	Starter motor	4-16	2-5

	Connector No.	Parts name	Circuit diagram page	Wiring diagram page
A	A-37	Front fog lamp (RH)	4-44	2-5
	A-38	Horn (RH)	4-61	2-5
	A-39	Condenser fan motor	4-29, 79	2-5
	A-40	Alternator relay	4-18	2-5
	A-41	Headlamp assembly (RH)	4-30, 34, 38, 40	2-5
	A-44	Front combination lamp (RH)	4-56	2-5
	A-47	Dual pressure switch	4-23, 77	2-5
	A-49	Power steering oil pressure switch	4-26	2-5
	A-50	Injector NO, 1	4-26	2-6
	A-54	Idle air control motor	4-26	2-6
	A-55	Windshield wiper motor	4-80	2-6
	A-56	Injector NO, 2	4-26	2-6
	A-58	Fuel pump check connector	4-20	2-6
	A-59	Engine speed detection connector	4-17, 21	2-6
	A-60	Ignition timing adjustment connector	4-26	2-6
	A-61	Injector NO, 3	4-26	2-6
	A-62	Ignition coil	4-17, 21	2-6
	A-63	Throttle position sensor	4-24, 100	2-6
	A-64	Capacitor	4-17, 21	2-6
	A-66	Purge solenoid valve	4-25	2-6
	A-67	Brake fluid level switch	4-66	2-6
	A-73	Windshield washer fluid level switch or headlamp washer motor	4-81, 88	2-6
	A-75	Windshield washer motor	4-80	2-6
	A-76	Vehicle speed sensor	4-26, 28, 64, 78, 100	2-6
	A-81	Camshaft position sensor	4-24	2-7
	A-84	Back-up lamp switch	4-60	2-7
	A-91	EGR solenoid valve	4-25	2-7
A-92	Power transistor	4-17, 21	2-7	
A-93	Injector NO, 4	4-26	2-7	
A-94	Oxygen sensor	4-25	2-7	
A-95	A/C compressor	4-23, 77	2-7	

	Connector No.	Parts name	Circuit diagram page	Wiring diagram page
A	A-96	Engine coolant temperature gauge unit	4-63	2-7
	A-97	Engine coolant temperature sensor	4-25, 28, 78	2-7
	A-102	Air flow sensor	4-24	2-7
	A-105	Auto-cruise control vacuum pump	4-99	2-7
	A-113	Side turn-signal lamp (RH)	4-56	2-7
	A-114	Side turn-signal lamp (LH)	4-56	2-7
	A-115	Engine oil level sensor	4-67	2-7
	A-116	DRL relay (1)	4-35	2-7
	A-117	DRL relay (2)	4-34	2-7
	A-118	Oil pressure gauge unit	4-62	2-7
B	B-04	Clutch pedal position switch	4-101	2-8
	B-05	Stop lamp switch <without auto-cruise control system> or no connection <with auto-cruise control system>	4-58, 96, 99	2-8
	B-06	Stop lamp switch <with auto-cruise control system> or no connection <without auto-cruise control system>	4-58, 96, 99	2-8
	B-07	J/C (1)	4-3, 27, 31, 36, 50, 51, 53, 58, 60, 61, 64, 71, 87, 96, 97, 99, 101, 102, 103, 105, 109	2-8
	B-08	J/C (2)	4-3, 23, 27, 31, 36, 40, 47, 50, 51, 53, 55, 72, 73, 77, 84, 87, 88, 89, 97, 101, 103, 105, 108, 109	2-8
	B-09	Ignition switch	4-14	2-8
	B-10	Column switch	4-31, 36, 40, 47, 88, 108	2-8
	B-11	Column switch	4-55, 88	2-8
	B-12	Column switch	4-80	2-8
	B-13	Diode (for idle up circuit)	4-25	2-8
	B-15	Blower control panel illumination lamp	4-74, 76	2-8
	B-16	Blower switch	4-74, 76	2-8
	B-17	A/C switch	4-74, 77	2-8
	B-18	Turn signal and hazard flasher unit	4-54	2-8
	B-22	Blower resister	4-74, 76	2-8
B-24	Blower motor	4-74, 76	2-8	
B-25	A/C-ECU	4-23, 29, 77	2-8	

	Connector No.	Parts name	Circuit diagram page	Wiring diagram page
B	B-27	Body wiring harness and door wiring harness (RH) combination	4-70, 73, 89, 91	2-8
	B-28	Foot lamp (RH)	4-51	2-9
	B-29	Auto-cruise-ECU	4-98, 100, 101	2-9
	B-30	Air bag module (passenger's side)	4-102	2-9
	B-31	Radio	4-90, 91	2-9
	B-32	Door lock power relay	4-70	2-9
	B-34	Cigarette lighter illumination lamp	4-92	2-9
	B-35	Cigarette lighter	4-92	2-9
	B-36	Cigarette lighter	4-92	2-9
	B-38	Diagnosis connector	4-27, 50, 53, 64, 71, 87, 97, 101, 103, 105, 109	2-9
	B-39	Key reminder switch	4-53, 72, 109	2-9
	B-40	Clock spring	4-61, 99	2-9
	B-41	Air bag module (driver's side)	4-102	2-9
	B-42X	Power window relay	4-9, 73	2-9
	B-46	Foot lamp (LH)	4-51	2-9
	B-47	ETACS-ECU	4-2, 3, 50, 53, 71, 72, 87, 108	2-9
	B-48	ETACS-ECU	4-50, 53, 71, 72, 87, 109	2-9
	B-49	Body wiring harness and J/B combination	4-2, 3, 15, 18, 22, 28, 35, 39, 45, 47, 50, 53, 54, 55, 60, 63, 64, 66, 72, 73, 74, 76, 81, 84, 86, 87, 88, 90, 91, 92, 94, 95, 98, 99, 102, 104, 109, 110	2-9
	B-50	Body wiring harness and J/B combination	4-2, 3, 27, 50, 53, 55, 64, 71, 73, 74, 76, 80, 84, 87, 88, 90, 94, 97, 98, 102, 103, 104, 105, 109, 110	2-9
	B-51	Body wiring harness and J/B combination	4-2, 3, 50, 53, 55, 60, 70, 71, 72, 74, 76, 85, 87, 89, 90, 92, 102, 109, 110	2-9
	B-52	Body wiring harness and door wiring harness (LH) combination	4-71, 73, 89, 91	2-9
	B-53	Engine-ECU	4-17, 20, 21, 23, 24, 25, 26, 27, 28, 77, 78, 104	2-10
	B-54	Engine-ECU	4-17, 20, 21, 22, 23, 25, 26, 77, 104	2-10
	B-56	Engine-ECU	4-17, 21, 22, 24, 25, 26, 27, 28, 78, 100	2-10
	B-58	ABS-ECU	4-94, 96, 97	2-10

	Connector No.	Parts name	Circuit diagram page	Wiring diagram page
B	B-59	Body wiring harness and front wiring harness combination	4-94, 95, 96, 97	2-10
	B-63	Body wiring harness and control wiring harness combination	4-16, 17, 20, 21, 22, 23, 25, 27, 28, 60, 64, 67, 77, 78, 80, 100, 104	2-10
	B-64	Body wiring harness and control wiring harness combination	4-99, 100, 101, 104	2-10
	B-65	Roof wiring harness and J/B combination	4-2, 3, 50, 110	2-10
	B-66	Instrument panel wiring harness and J/B combination	4-2, 3, 18, 22, 39, 45, 47, 49, 52, 54, 55, 62, 63, 64, 66, 81, 86, 95, 98, 99, 102	2-10
	B-67	Defogger relay	4-3, 87	2-10
	B-68	Blower relay	4-3, 74, 76	2-10
	B-69	Rear wiring harness and J/B combination	4-2, 3, 41, 52, 53, 55, 60, 72, 84, 87, 91, 109, 110	2-10
	B-71	Body wiring harness and rear wiring harness combination	4-47, 52, 63, 67, 84, 91, 96	2-10
	B-72	Body wiring harness and rear wiring harness combination	4-20, 41, 59, 106	2-10
	B-74	Front wiring harness and J/B combination	4-2, 3, 13, 70, 74, 76, 87	2-10
	B-75	Front wiring harness and J/B combination	4-2, 3, 15, 18, 27, 28, 35, 39, 41, 45, 46, 49, 50, 53, 54, 55, 62, 64, 70, 74, 76, 85, 86, 87, 89, 90, 92, 97, 98, 99, 103, 105, 108, 109	2-11
	B-76	Body wiring harness and front wiring harness combination	4-23, 25, 29, 30, 34, 35, 40, 44, 46, 61, 77, 80, 81, 88, 108	2-11
	B-77	Body wiring harness and front wiring harness combination	4-31, 36, 58, 73, 88, 96, 99, 106	2-11
	B-78	Body wiring harness and front wiring harness combination	4-10, 110	2-11
	B-79	Body wiring harness and roof wiring harness combination	4-51, 110	2-11
	B-82	Dedicated fuse (with auto-cruise control system)	4-99	2-11
	B-83	Remote controlled mirror switch	4-89	2-11
	B-84	Rear wiper and washer switch	4-85	2-11
B-86	Fuel pump relay	4-20	2-11	
B-87	MPI relay	4-20, 104	2-11	
B-88	Engine oil level relay	4-67	2-11	
B-89	Fuel octane ratio selection connector	4-25	2-11	

	Connector No.	Parts name	Circuit diagram page	Wiring diagram page
B	B-90	Headlamp washer relay	4-88	2-11
	B-91	Ignition key ring antenna	4-105	2-11
	B-92X	Rear fog lamp relay	4-9, 46	2-11
	B-93	Immobilizer-ECU	4-27, 105	2-11
	B-94	Diode (for headlamp circuit)	4-31, 36, 47	2-11
C	C-01	Front speaker (LH)	4-91	2-12
	C-03	Auto-cruise control main switch	4-98	2-12
	C-04	Combination meter	4-18, 22, 62, 63, 66, 95, 102	2-12
	C-05	Combination meter	4-31, 34, 47, 52, 55, 63, 64, 100	2-12
	C-06	Combination meter	4-18, 22, 62, 63, 64, 66, 67, 81, 95, 100, 102	2-12
	C-07	Hazard warning lamp switch	4-54	2-12
	C-08	Defogger switch	4-86	2-12
	C-10	Front speaker (RH)	4-91	2-12
	C-12	Glove box lamp	4-49	2-12
	C-13	Glove box lamp switch	4-49	2-12
	C-16	Ashtray illumination lamp	4-92	2-12
	C-17	Parking brake switch	4-66	2-12
	C-18	SRS-ECU	4-102	2-12
	C-21	Instrument panel wiring harness and body wiring harness combination	4-46, 47, 54, 64, 66, 91, 95, 100, 101	2-12
	C-22	Instrument panel wiring harness and control wiring harness combination	4-22, 26, 63, 64, 66, 67, 100	2-12
	C-23	Rheostat	4-62	2-12
	C-24	Instrument panel wiring harness and body wiring harness combination	4-45, 52, 63, 67, 74, 76, 81, 85, 89, 90, 92, 98, 99	2-12
	C-25	Instrument panel wiring harness and front wiring harness combination	4-18, 31, 39, 45, 46, 62, 66, 95	2-12
	C-27	Front fog lamp switch	4-45, 46	2-12
	C-28	Diode (for door-ajar warning lamp circuit)	4-52	2-12
C-29	Headlamp leveling switch	4-39	2-12	
C-30	Rear fog lamp switch	4-46	2-12	

	Connector No.	Parts name	Circuit diagram page	Wiring diagram page
D	D-01	Power window motor (RH)	4-73	2-13
	D-02	Door mirror (RH)	4-89	2-13
	D-03	Door speaker (RH)	4-91	2-13
	D-04	Power window sub switch	4-73	2-13
	D-05	Door lock key cylinder switch (RH)	4-70	2-13
	D-06	Door lock actuator (RH)	4-70	2-13
	D-07	Door lock actuator (LH)	4-71	2-13
	D-09	Power window main switch	4-73	2-13
	D-10	Door speaker (LH)	4-91	2-13
	D-11	Power window motor (LH)	4-73	2-13
	D-12	Door mirror (LH)	4-89	2-13
	E	E-02	Room lamp <with sunroof>	4-51
E-03		Sunroof motor	4-110	2-14
E-04		Room lamp <without sunroof>	4-51	2-14
E-05		Sunroof switch	4-110	2-14
E-06		Sunroof-ECU	4-110	2-14
E-09		Rear wiring harness and fuel wiring harness combination	4-63, 96	2-14
E-10		Defogger (+)	4-87	2-14
E-11		Door switch (RH)	4-52, 72	2-14
E-13		Rear speaker (RH)	4-91	2-14
E-14		Defogger (-)	4-87	2-14
E-15		Rear wiper motor	4-84	2-14
E-16		High-mounted stop lamp	4-59	2-14
E-17		Rear combination lamp (RH)	4-55	2-14
E-18		Rear combination lamp (RH)	4-41, 47, 59	2-14
E-19		Luggage compartment lamp switch	4-52	2-14
E-22		Back-up lamp (RH)	4-60	2-14
E-23		Licence plate lamp (RH)	4-41	2-14
E-24		Licence plate lamp (LH)	4-41	2-15
E-25	Rear wiring harness and licence plate lamp wiring harness combination	4-41, 60	2-15	
E-26	Rear combination lamp (LH)	4-41, 47, 59	2-15	

	Connector No.	Parts name	Circuit diagram page	Wiring diagram page
E	E-27	Back-up lamp (LH)	4-60	2-15
	E-31	Rear combination lamp (LH)	4-55	2-15
	E-32	Rear washer motor	4-84	2-15
	E-33	ABS wheel-speed sensor (rear: RH)	4-96	2-15
	E-34	Luggage compartment lamp	4-52	2-15
	E-35	ABS wheel-speed sensor (rear: LH)	4-96	2-15
	E-36	Fuel pump	4-20	2-15
	E-37	Fuel gauge unit	4-63, 67	2-15
	E-40	Rear speaker (LH)	4-91	2-15
	E-43	Door switch (LH)	4-52, 53, 72, 109, 110	2-15
	E-44	Rear wiring harness and tailgate wiring harness combination	4-59, 84, 87	2-15
	E-45	Power seat assembly	4-107	2-15
	E-48	Motor antenna assembly	4-91	2-15

INDEX (In order of parts name)

	Parts name	Connector No.	Circuit diagram page	Wiring diagram page
A	A/C compressor	A-95	4-23, 77	2-7
	A/C compressor clutch relay	A-18X	4-9, 23, 77	2-4
	A/C switch	B-17	4-74, 77	2-8
	A/C-ECU	B-25	4-23, 29, 77	2-8
	ABS wheel-speed sensor (front: LH)	A-08	4-97	2-4
	ABS wheel-speed sensor (front: RH)	A-01	4-97	2-4
	ABS wheel-speed sensor (rear: LH)	E-35	4-96	2-15
	ABS wheel-speed sensor (rear: RH)	E-33	4-96	2-15
	ABS-ECU	B-58	4-94, 96, 97	2-10
	Air bag module (driver's side)	B-41	4-102	2-9
	Air bag module (passenger's side)	B-30	4-102	2-9
	Air flow sensor	A-102	4-24	2-7
	Alternator	A-02	4-18	2-4
	Alternator	A-03	4-18	2-4
	Alternator relay	A-40	4-18	2-5
	Ashtray illumination lamp	C-16	4-92	2-12
	Auto-cruise control main switch	C-03	4-98	2-12
	Auto-cruise control vacuum pump	A-105	4-99	2-7
Auto-cruise-ECU	B-29	4-98, 100, 101	2-9	
B	Back-up lamp (LH)	E-27	4-60	2-15
	Back-up lamp (RH)	E-22	4-60	2-14
	Back-up lamp switch	A-84	4-60	2-7
	Blower control panel illumination lamp	B-15	4-74, 76	2-8
	Blower motor	B-24	4-74, 76	2-8
	Blower relay	B-68	4-3, 74, 76	2-10
	Blower resister	B-22	4-74, 76	2-8
	Blower switch	B-16	4-74, 76	2-8
	Body wiring harness and control wiring harness combination	B-63	4-16, 17, 20, 21, 22, 23, 25, 27, 28, 60, 64, 67, 77, 78, 80, 100, 104	2-10
	Body wiring harness and control wiring harness combination	B-64	4-99, 100, 101, 104	2-10

	Parts name	Connector No.	Circuit diagram page	Wiring diagram page
B	Body wiring harness and door wiring harness (LH) combination	B-52	4-71, 73, 89, 91	2-9
	Body wiring harness and door wiring harness (RH) combination	B-27	4-70, 73, 89, 91	2-8
	Body wiring harness and front wiring harness combination	B-59	4-94, 95, 96, 97	2-10
	Body wiring harness and front wiring harness combination	B-76	4-23, 25, 29, 30, 34, 35, 40, 44, 46, 61, 77, 80, 81, 88, 108	2-11
	Body wiring harness and front wiring harness combination	B-77	4-31, 36, 58, 73, 88, 96, 99, 106	2-11
	Body wiring harness and front wiring harness combination	B-78	4-10, 110	2-11
	Body wiring harness and J/B combination	B-49	4-2, 3, 15, 18, 22, 28, 35, 39, 45, 47, 50, 53, 54, 55, 60, 63, 64, 66, 72, 73, 74, 76, 81, 84, 86, 87, 88, 90, 91, 92, 94, 95, 98, 99, 102, 104, 109, 110	2-9
	Body wiring harness and J/B combination	B-50	4-2, 3, 27, 50, 53, 55, 64, 71, 73, 74, 76, 80, 84, 87, 88, 90, 94, 97, 98, 102, 103, 104, 105, 109, 110	2-9
	Body wiring harness and J/B combination	B-51	4-2, 3, 50, 53, 55, 60, 70, 71, 72, 74, 76, 85, 87, 89, 90, 92, 102, 109, 110	2-9
	Body wiring harness and rear wiring harness combination	B-71	4-47, 52, 63, 67, 84, 91, 96	2-10
	Body wiring harness and rear wiring harness combination	B-72	4-20, 41, 59, 106	2-10
	Body wiring harness and roof wiring harness combination	B-79	4-51, 110	2-11
	Brake fluid level switch	A-67	4-66	2-6
C	Camshaft position sensor	A-81	4-24	2-7
	Capacitor	A-64	4-17, 21	2-6
	Cigarette lighter	B-35	4-92	2-9
	Cigarette lighter	B-36	4-92	2-9
	Cigarette lighter illumination lamp	B-34	4-92	2-9
	Clock spring	B-40	4-61, 99	2-9
	Clutch pedal position switch	B-04	4-101	2-8
	Column switch	B-10	4-31, 36, 40, 47, 88, 108	2-8
	Column switch	B-11	4-55, 88	2-8
	Column switch	B-12	4-80	2-8

	Parts name	Connector No.	Circuit diagram page	Wiring diagram page
C	Combination meter	C-04	4-18, 22, 62, 63, 66, 95, 102	2-12
	Combination meter	C-05	4-31, 34, 47, 52, 55, 63, 64, 100	2-12
	Combination meter	C-06	4-18, 22, 62, 63, 64, 66, 67, 81, 95, 100, 102	2-12
	Condenser fan motor	A-39	4-29, 79	2-5
	Condenser fan relay (HI)	A-10X	4-9, 29, 79	2-4
	Condenser fan relay (LO)	A-09X	4-9, 29, 79	2-4
	Control wiring harness and battery cable combination	A-34	4-16	2-5
	Crankshaft position sensor	A-04	4-24	2-4
D	Dedicated fuse (with auto-cruise control system)	B-82	4-99	2-11
	Defogger (+)	E-10	4-87	2-14
	Defogger (-)	E-14	4-87	2-14
	Defogger relay	B-67	4-3, 87	2-10
	Defogger switch	C-08	4-86	2-12
	Detonation sensor	A-05	4-26	2-4
	Diagnosis connector	B-38	4-27, 50, 53, 64, 71, 87, 97, 101, 103, 105, 109	2-9
	Diode (for door-ajar warning lamp circuit)	C-28	4-52	2-12
	Diode (for headlamp circuit)	B-94	4-31, 36, 47	2-11
	Diode (for idle up circuit)	B-13	4-25	2-8
	Door lock actuator (LH)	D-07	4-71	2-13
	Door lock actuator (RH)	D-06	4-70	2-13
	Door lock key cylinder switch (RH)	D-05	4-70	2-13
	Door lock power relay	B-32	4-70	2-9
	Door mirror (LH)	D-12	4-89	2-13
	Door mirror (RH)	D-02	4-89	2-13
	Door speaker (LH)	D-10	4-91	2-13
	Door speaker (RH)	D-03	4-91	2-13
	Door switch (LH)	E-43	4-52, 53, 72, 109, 110	2-15
	Door switch (RH)	E-11	4-52, 72	2-14
DRL relay (1)	A-116	4-35	2-7	
DRL relay (2)	A-117	4-34	2-7	
D	DRL-ECU	A-27	4-35, 40, 44, 46, 47, 108	2-5
	Dual pressure switch	A-47	4-23, 77	2-5

	Parts name	Connector No.	Circuit diagram page	Wiring diagram page
E	EGR solenoid valve	A-91	4-25	2-7
	Engine coolant temperature gauge unit	A-96	4-63	2-7
	Engine coolant temperature sensor	A-97	4-25, 28, 78	2-7
	Engine oil level relay	B-88	4-67	2-11
	Engine oil level sensor	A-115	4-67	2-7
	Engine speed detection connector	A-59	4-17, 21	2-6
	Engine-ECU	B-53	4-17, 20, 21, 23, 24, 25, 26, 27, 28, 77, 78, 104	2-10
	Engine-ECU	B-54	4-17, 20, 21, 22, 23, 25, 26, 77, 104	2-10
	Engine-ECU	B-56	4-17, 21, 22, 24, 25, 26, 27, 28, 78, 100	2-10
	ETACS-ECU	B-47	4-2, 3, 50, 53, 71, 72, 87, 108	2-9
	ETACS-ECU	B-48	4-50, 53, 71, 72, 87, 109	2-9
F	Foot lamp (LH)	B-46	4-51	2-9
	Foot lamp (RH)	B-28	4-51	2-9
	Front combination lamp (LH)	A-20	4-56	2-4
	Front combination lamp (RH)	A-44	4-56	2-5
	Front fog lamp (LH)	A-30	4-44	2-5
	Front fog lamp (RH)	A-37	4-44	2-5
	Front fog lamp relay	A-16X	4-9, 44	2-4
	Front fog lamp switch	C-27	4-45, 46	2-12
	Front speaker (LH)	C-01	4-91	2-12
	Front speaker (RH)	C-10	4-91	2-12
	Front wiring harness and control wiring harness combination	A-32	4-20, 23, 26, 28, 29, 67, 77, 78, 79, 104	2-5
	Front wiring harness and J/B combination	B-74	4-2, 3, 13, 70, 74, 76, 87	2-10
	Front wiring harness and J/B combination	B-75	4-2, 3, 15, 18, 27, 28, 35, 39, 41, 45, 46, 49, 50, 53, 54, 55, 62, 64, 70, 74, 76, 85, 86, 87, 89, 90, 92, 97, 98, 99, 103, 105, 108, 109	2-11
F	Front wiring harness and joint wiring harness combination	A-26	4-62	2-4
	Fuel gauge unit	E-37	4-63, 67	2-15
	Fuel octane ratio selection connector	B-89	4-25	2-11
	Fuel pump	E-36	4-20	2-15
	Fuel pump check connector	A-58	4-20	2-6
	Fuel pump relay	B-86	4-20	2-11

	Parts name	Connector No.	Circuit diagram page	Wiring diagram page
G	Glove box lamp	C-12	4-49	2-12
	Glove box lamp switch	C-13	4-49	2-12
H	Hazard warning lamp switch	C-07	4-54	2-12
	Headlamp assembly (LH)	A-25	4-30, 34, 38, 40	2-4
	Headlamp assembly (RH)	A-41	4-30, 34, 38, 40	2-5
	Headlamp leveling switch	C-29	4-39	2-12
	Headlamp relay	A-14X	4-9, 11, 30, 34	2-4
	Headlamp washer relay	B-90	4-88	2-11
	High-mounted stop lamp	E-16	4-59	2-14
	Horn (LH)	A-28	4-61	2-5
	Horn (RH)	A-38	4-61	2-5
	Horn relay	A-17X	4-9, 61	2-4
	Hydraulic unit	A-23	4-94	2-4
	Hydraulic unit	A-24	4-95	2-4
I	Idle air control motor	A-54	4-26	2-6
	Ignition coil	A-62	4-17, 21	2-6
	Ignition key ring antenna	B-91	4-105	2-11
	Ignition switch	B-09	4-14	2-8
	Ignition timing adjustment connector	A-60	4-26	2-6
	Immobilizer-ECU	B-93	4-27, 105	2-11
	Injector NO, 1	A-50	4-26	2-6
	Injector NO, 2	A-56	4-26	2-6
	Injector NO, 3	A-61	4-26	2-6
	Injector NO, 4	A-93	4-26	2-7
	Instrument panel wiring harness and body wiring harness combination	C-21	4-46, 47, 54, 64, 66, 91, 95, 100, 101	2-12
I	Instrument panel wiring harness and body wiring harness combination	C-24	4-45, 52, 63, 67, 74, 76, 81, 85, 89, 90, 92, 98, 99	2-12
	Instrument panel wiring harness and control wiring harness combination	C-22	4-22, 26, 63, 64, 66, 67, 100	2-12
	Instrument panel wiring harness and front wiring harness combination	C-25	4-18, 31, 39, 45, 46, 62, 66, 95	2-12
	Instrument panel wiring harness and J/B combination	B-66	4-2, 3, 18, 22, 39, 45, 47, 49, 52, 54, 55, 62, 63, 64, 66, 81, 86, 95, 98, 99, 102	2-10

	Parts name	Connector No.	Circuit diagram page	Wiring diagram page
J	J/C (1)	B-07	4-3, 27, 31, 36, 50, 51, 53, 58, 60, 61, 64, 71, 87, 96, 97, 99, 101, 102, 103, 105, 109	2-8
	J/C (2)	B-08	4-3, 23, 27, 31, 36, 40, 47, 50, 51, 53, 55, 72, 73, 77, 84, 87, 88, 89, 97, 101, 103, 105, 108, 109	2-8
K	Key reminder switch	B-39	4-53, 72, 109	2-9
L	Licence plate lamp (LH)	E-24	4-41	2-15
	Licence plate lamp (RH)	E-23	4-41	2-14
	Luggage compartment lamp	E-34	4-52	2-15
	Luggage compartment lamp switch	E-19	4-52	2-14
M	Motor antenna assembly	E-48	4-91	2-15
	MPI relay	B-87	4-20, 104	2-11
O	Oil pressure gauge unit	A-118	4-62	2-7
	Oil pressure switch	A-31	4-66	2-5
	Oxygen sensor	A-94	4-25	2-7
P	Parking brake switch	C-17	4-66	2-12
	Power seat assembly	E-45	4-107	2-15
	Power steering oil pressure switch	A-49	4-26	2-5
	Power transistor	A-92	4-17, 21	2-7
	Power window main switch	D-09	4-73	2-13
	Power window motor (LH)	D-11	4-73	2-13
	Power window motor (RH)	D-01	4-73	2-13
	Power window relay	B-42X	4-9, 73	2-9
	Power window sub switch	D-04	4-73	2-13
	Purge solenoid valve	A-66	4-25	2-6

	Parts name	Connector No.	Circuit diagram page	Wiring diagram page
R	Radiator fan motor	A-33	4-29, 79	2-5
	Radiator fan relay (HI)	A-13X	4-9, 29, 79	2-4
	Radiator fan relay (LO)	A-11X	4-9, 28, 78	2-4
	Radio	B-31	4-90, 91	2-9
	Rear combination lamp (LH)	E-26	4-41, 47, 59	2-15
	Rear combination lamp (LH)	E-31	4-55	2-15
	Rear combination lamp (RH)	E-17	4-55	2-14
	Rear combination lamp (RH)	E-18	4-41, 47, 59	2-14
	Rear fog lamp relay	B-92X	4-9, 46	2-11
	Rear fog lamp switch	C-30	4-46	2-12
	Rear speaker (LH)	E-40	4-91	2-15
	Rear speaker (RH)	E-13	4-91	2-1
	Rear washer motor	E-32	4-84	2-15
	Rear wiper and washer switch	B-84	4-85	2-11
	Rear wiper motor	E-15	4-84	2-14
	Rear wiring harness and fuel wiring harness combination	E-09	4-63, 96	2-14
	Rear wiring harness and J/B combination	B-69	4-2, 3, 41, 52, 53, 55, 60, 72, 84, 87, 91, 109, 110	2-10
	Rear wiring harness and licence plate lamp wiring harness combination	E-25	4-41, 60	2-15
	Rear wiring harness and tailgate wiring harness combination	E-44	4-59, 84, 87	2-15
	Remote controlled mirror switch	B-83	4-89	2-11
Rheostat	C-23	4-62	2-12	
Roof wiring harness and J/B combination	B-65	4-2, 3, 50, 110	2-10	
Room lamp <with sunroof>	E-02	4-51	2-14	
Room lamp <without sunroof>	E-04	4-51	2-14	

	Parts name	Connector No.	Circuit diagram page	Wiring diagram page
S	Side turn-signal lamp (LH)	A-114	4-56	2-7
	Side turn-signal lamp (RH)	A-113	4-56	2-7
	SRS-ECU	C-18	4-102	2-12
	Starter motor	A-35	4-16	2-5
	Starter motor	A-36	4-16	2-5
	Stop lamp switch <with auto-cruise control system> or no connection <without auto-cruise control system>	B-06	4-58, 96, 99	2-8
	Stop lamp switch <without auto-cruise control system> or no connection <with auto-cruise control system>	B-05	4-58, 96, 99	2-8
	Sunroof motor	E-03	4-110	2-14
	Sunroof switch	E-05	4-110	2-14
	Sunroof-ECU	E-06	4-110	2-14
T	Tail lamp relay	A-15X	4-9, 11, 40, 44, 46, 108	2-4
	Throttle position sensor	A-63	4-24, 100	2-6
	Turn signal and hazard flasher unit	B-18	4-54	2-8
V	Vehicle speed sensor	A-76	4-26, 28, 64, 78, 100	2-6
W	Windshield washer fluid level switch or headlamp washer motor	A-73	4-81, 88	2-6
	Windshield washer motor	A-75	4-80	2-6
	Windshield wiper motor	A-55	4-80	2-6