

YMMS: 2016 Ford Edge Titanium  
 Engine: 3.5L Eng  
 VIN:

Nov 8, 2022  
 License:  
 Odometer:

## ENGINE PERFORMANCE > 2.0L TURBO

Fig 1: 2.0L Turbo, Engine Performance Circuit (1 of 7)

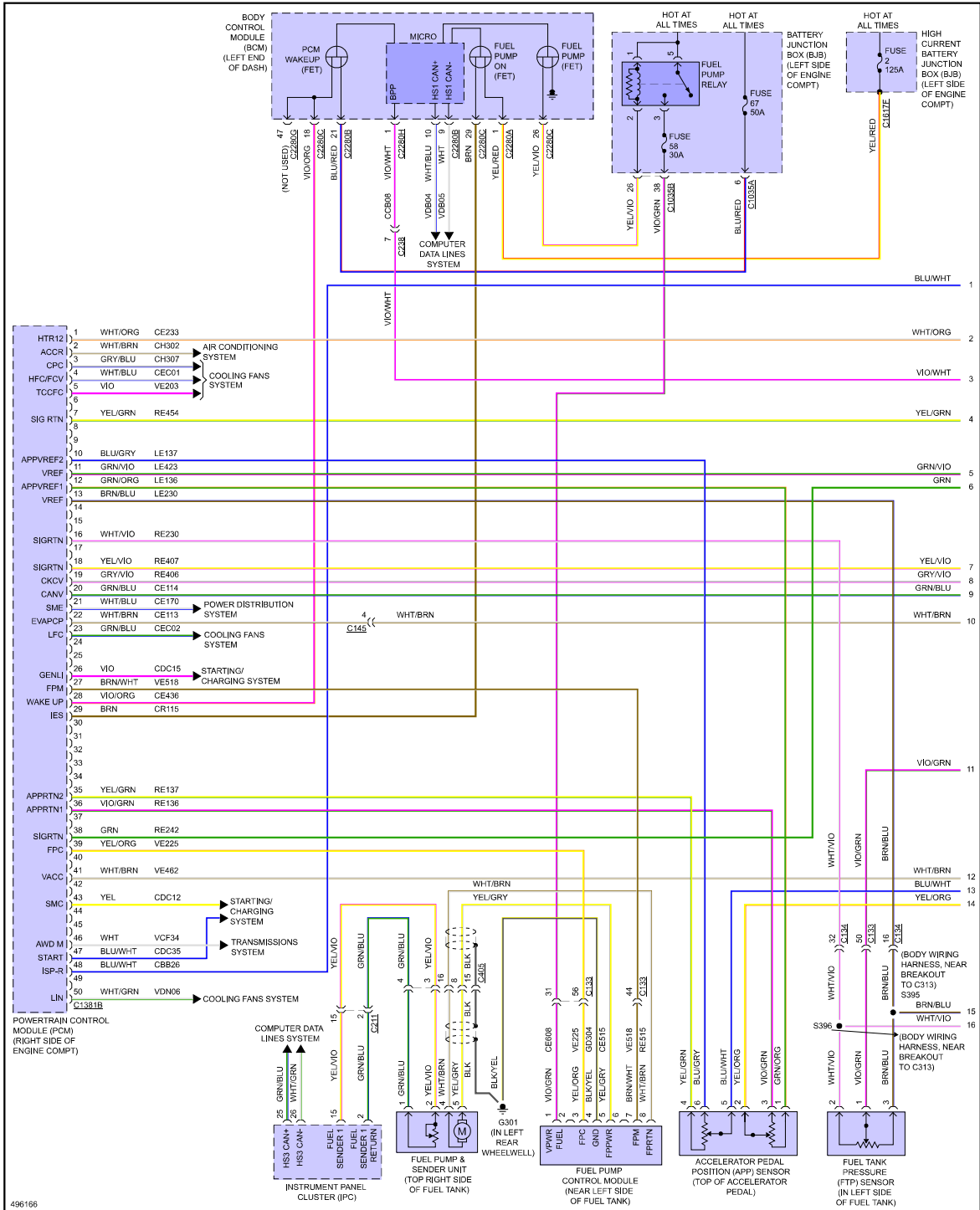

Fig 2: 2.0L Turbo, Engine Performance Circuit (2 of 7)

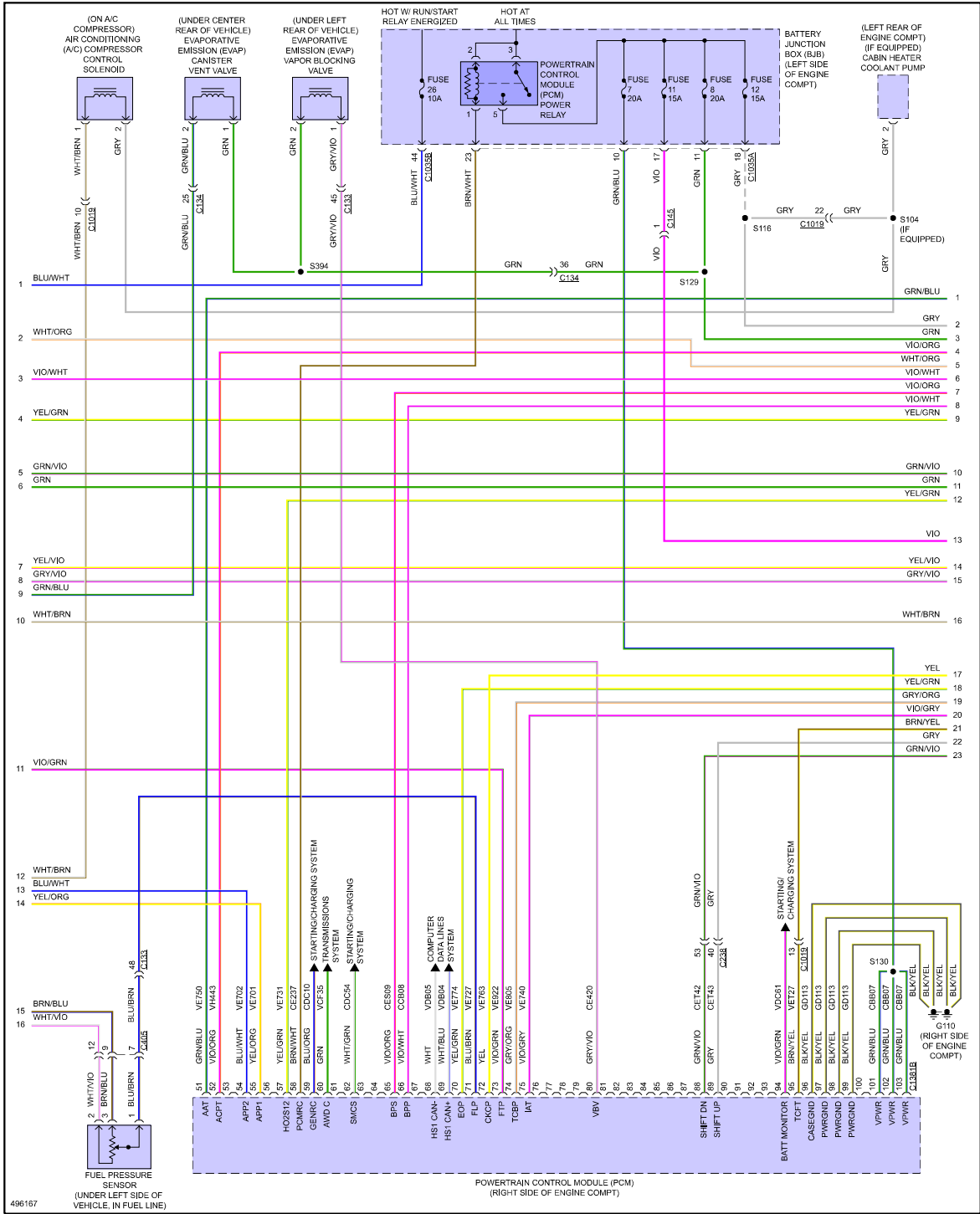

Fig 3: 2.0L Turbo, Engine Performance Circuit (3 of 7)

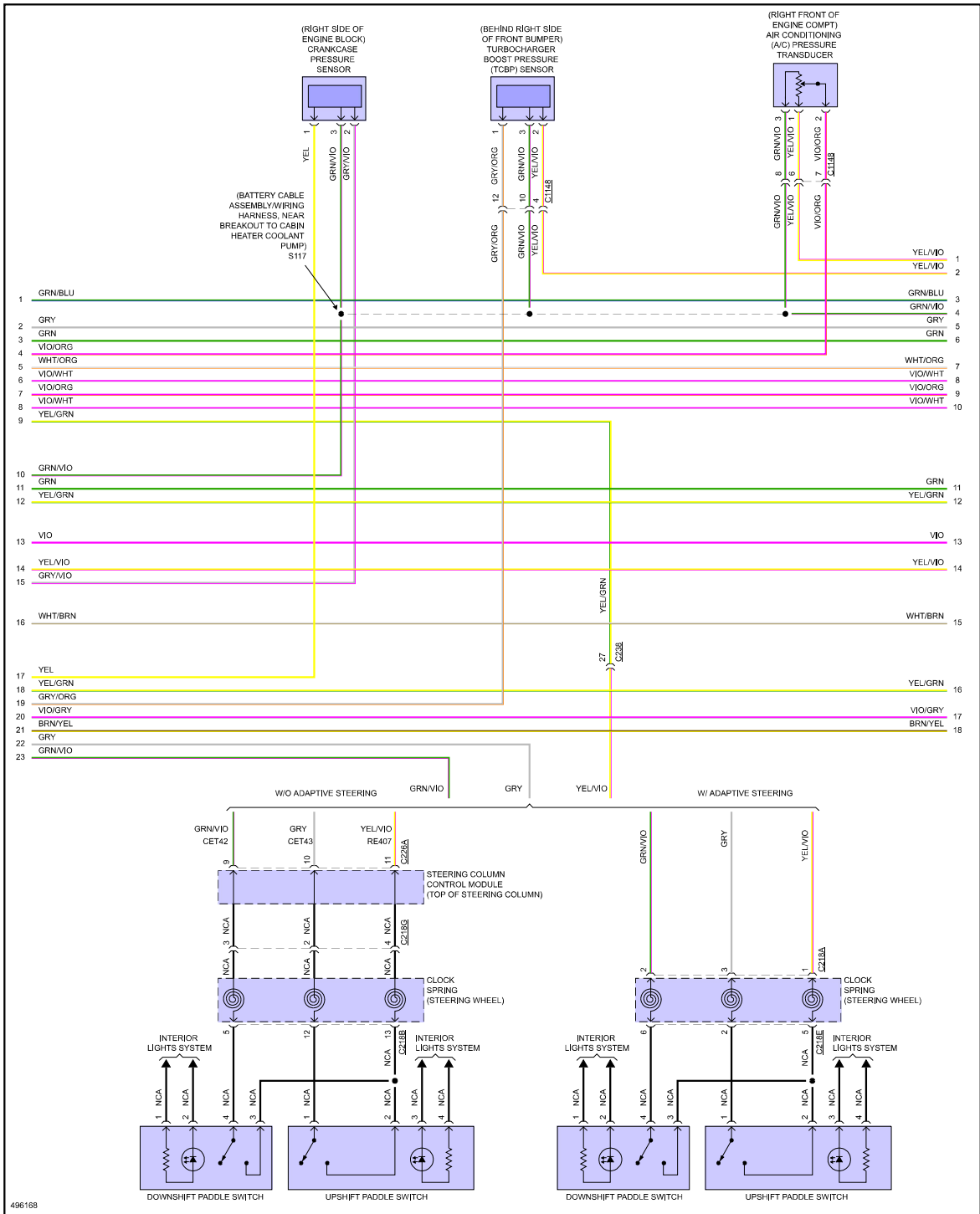

Fig 4: 2.0L Turbo, Engine Performance Circuit (4 of 7)

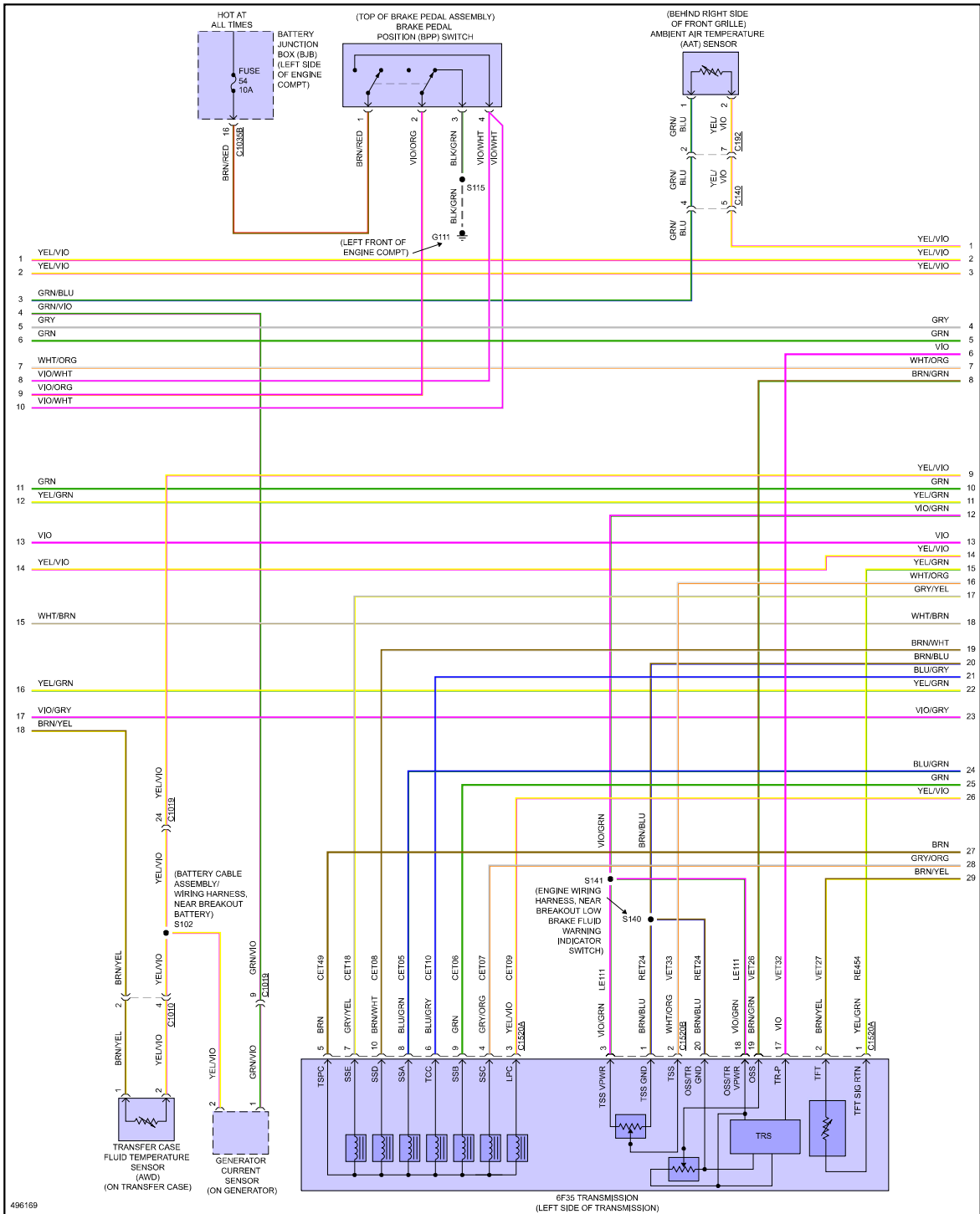



Fig 6: 2.0L Turbo, Engine Performance Circuit (6 of 7)

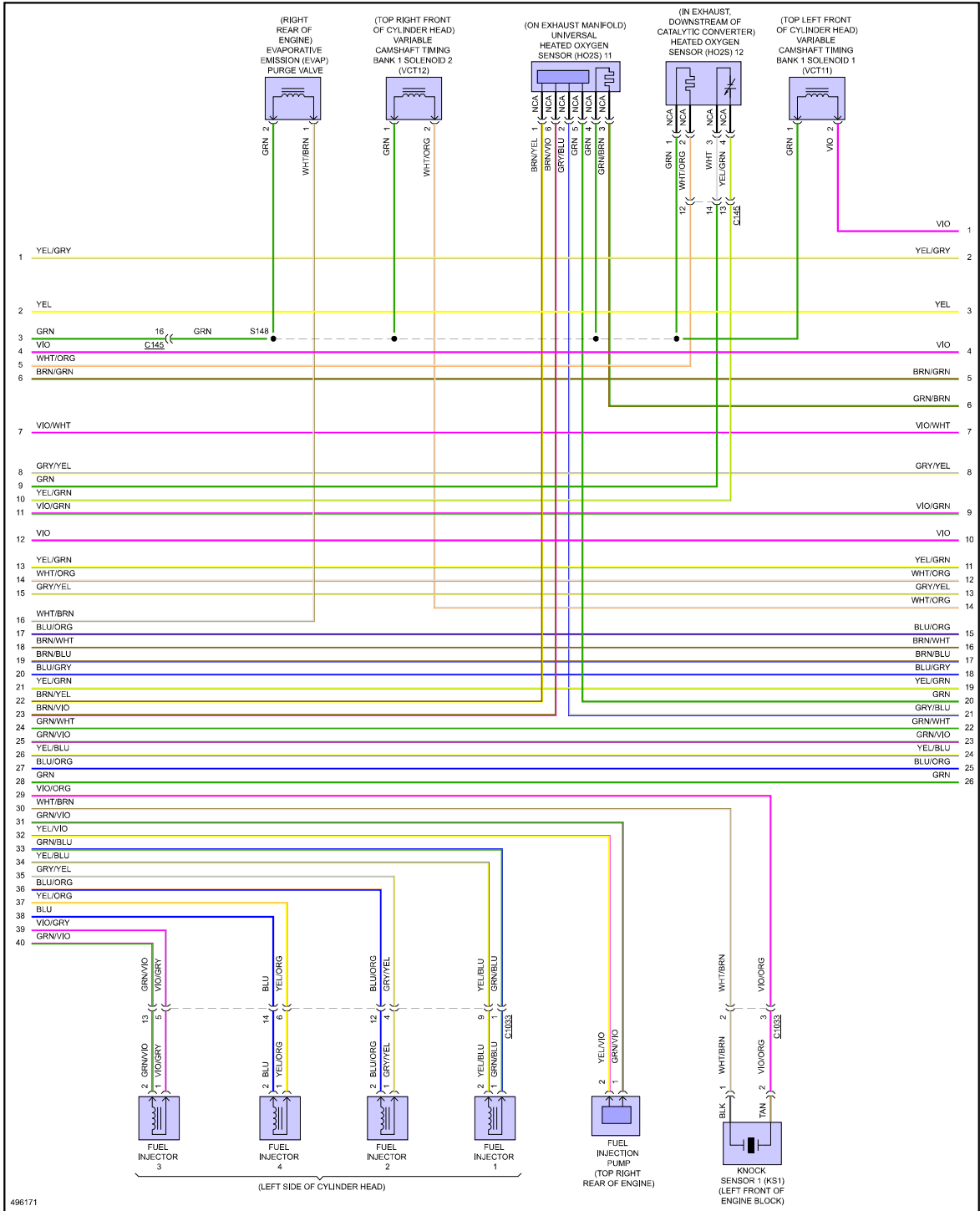

Fig 7: 2.0L Turbo, Engine Performance Circuit (7 of 7)

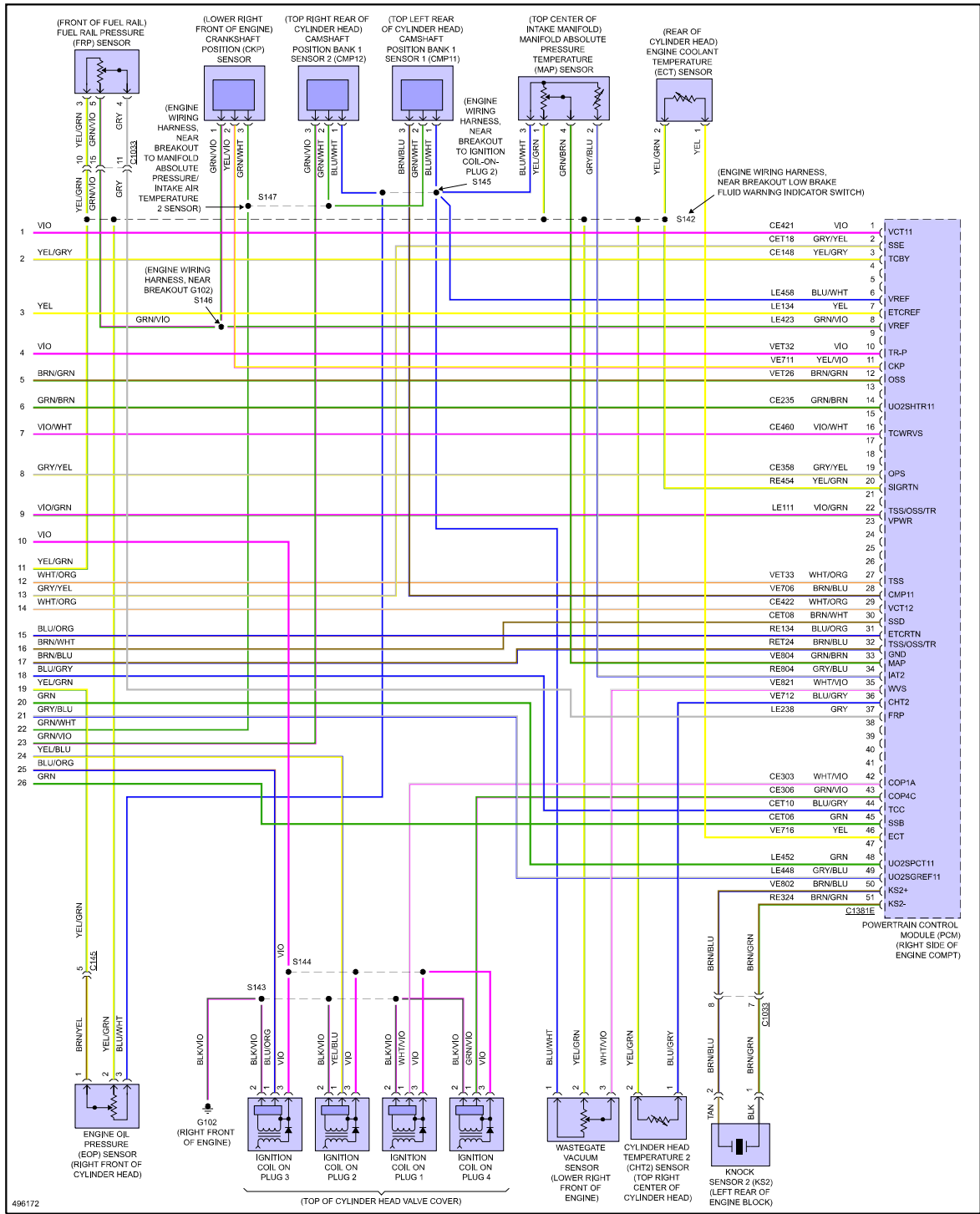





Fig 2: 2.7L Turbo, Engine Performance Circuit (2 of 9)

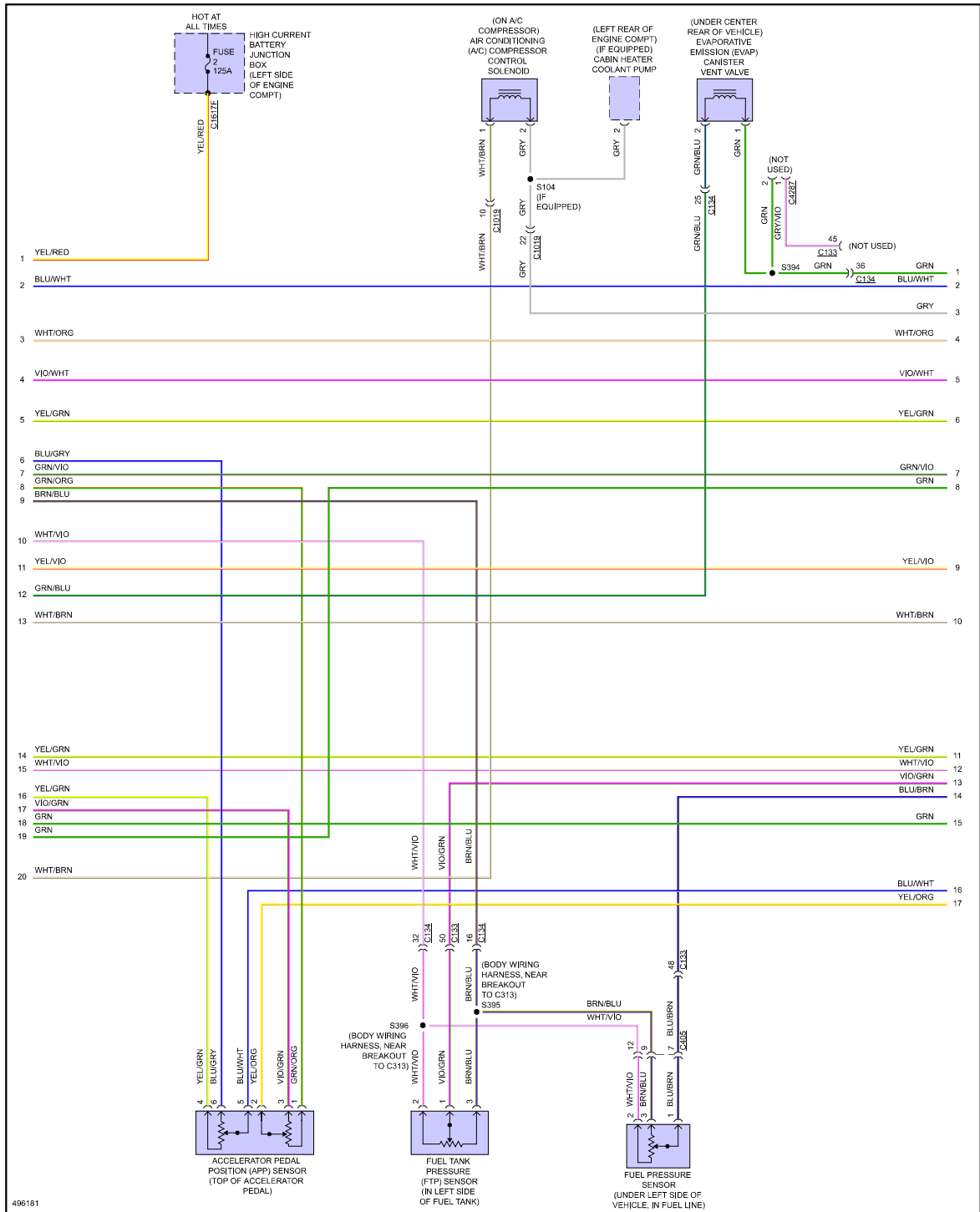



Fig 4: 2.7L Turbo, Engine Performance Circuit (4 of 9)

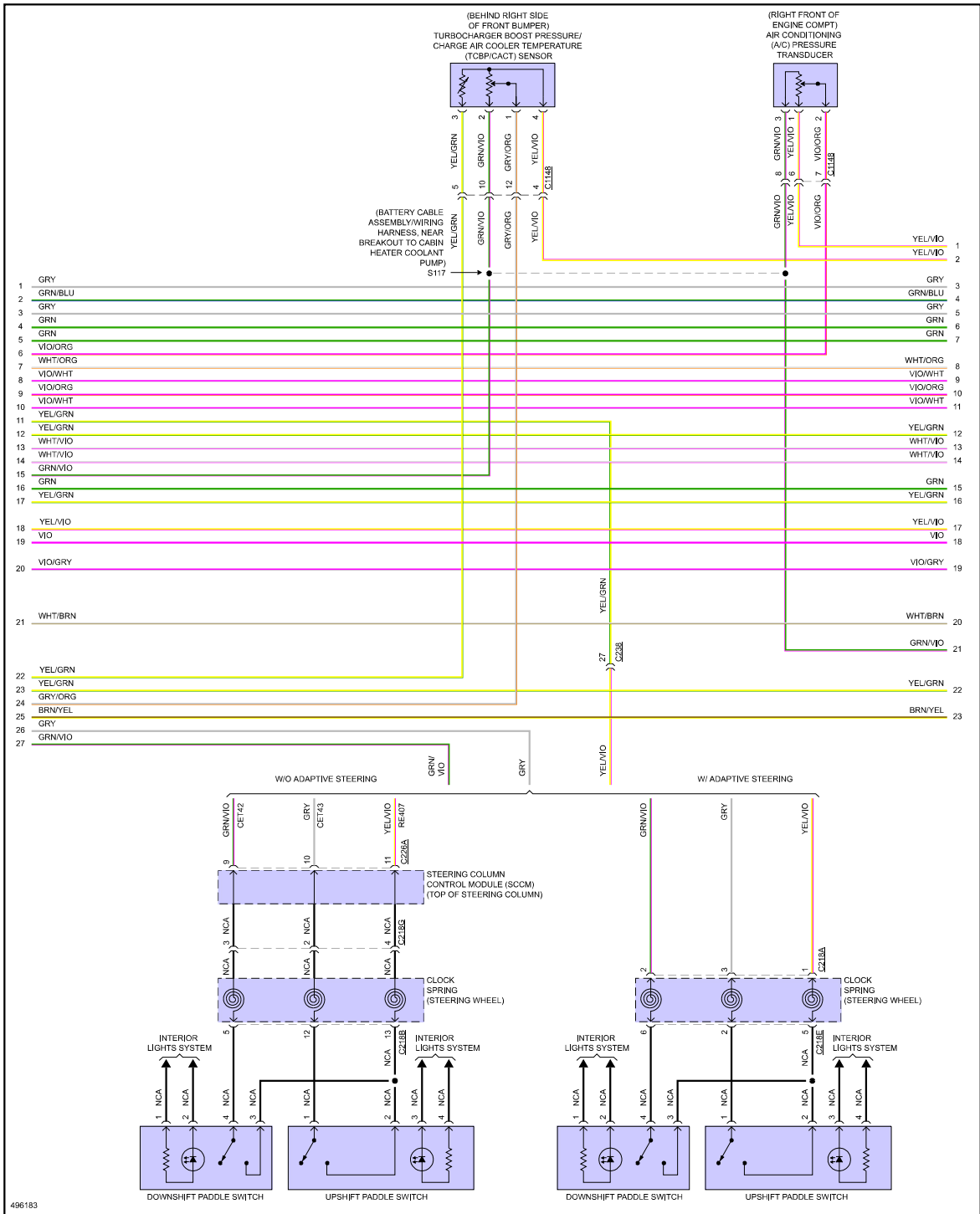

Fig 5: 2.7L Turbo, Engine Performance Circuit (5 of 9)

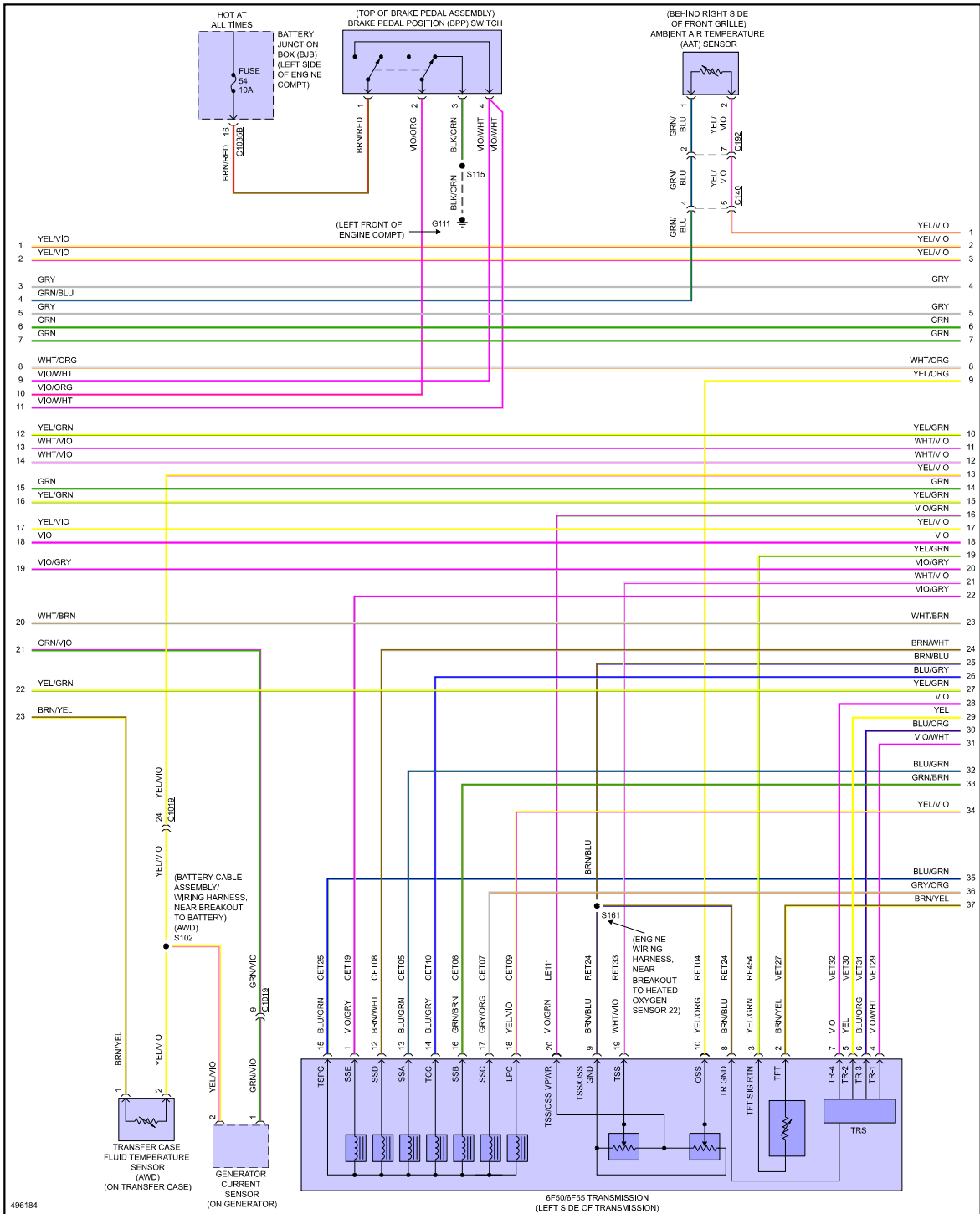

Fig 6: 2.7L Turbo, Engine Performance Circuit (6 of 9)

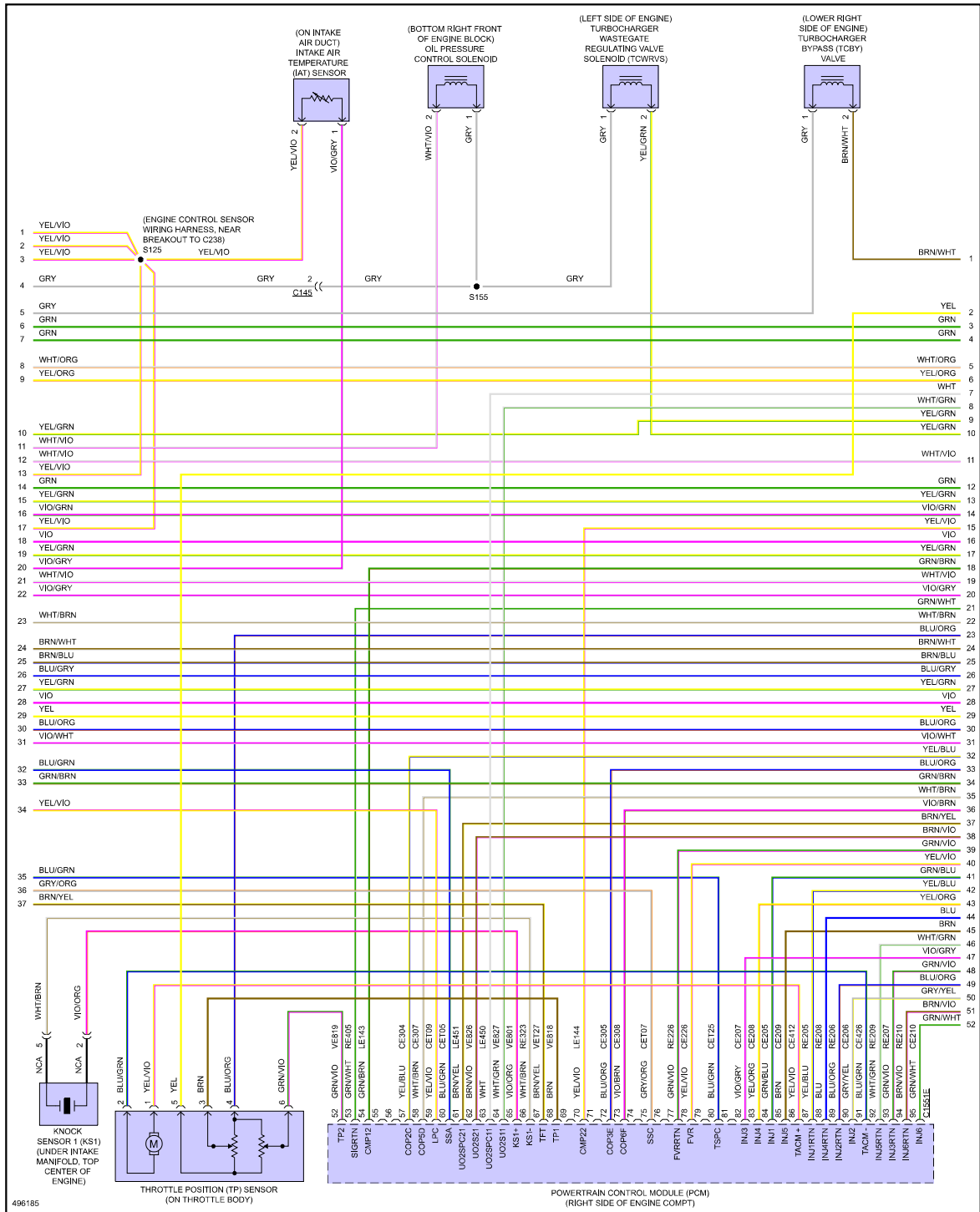

Fig 7: 2.7L Turbo, Engine Performance Circuit (7 of 9)

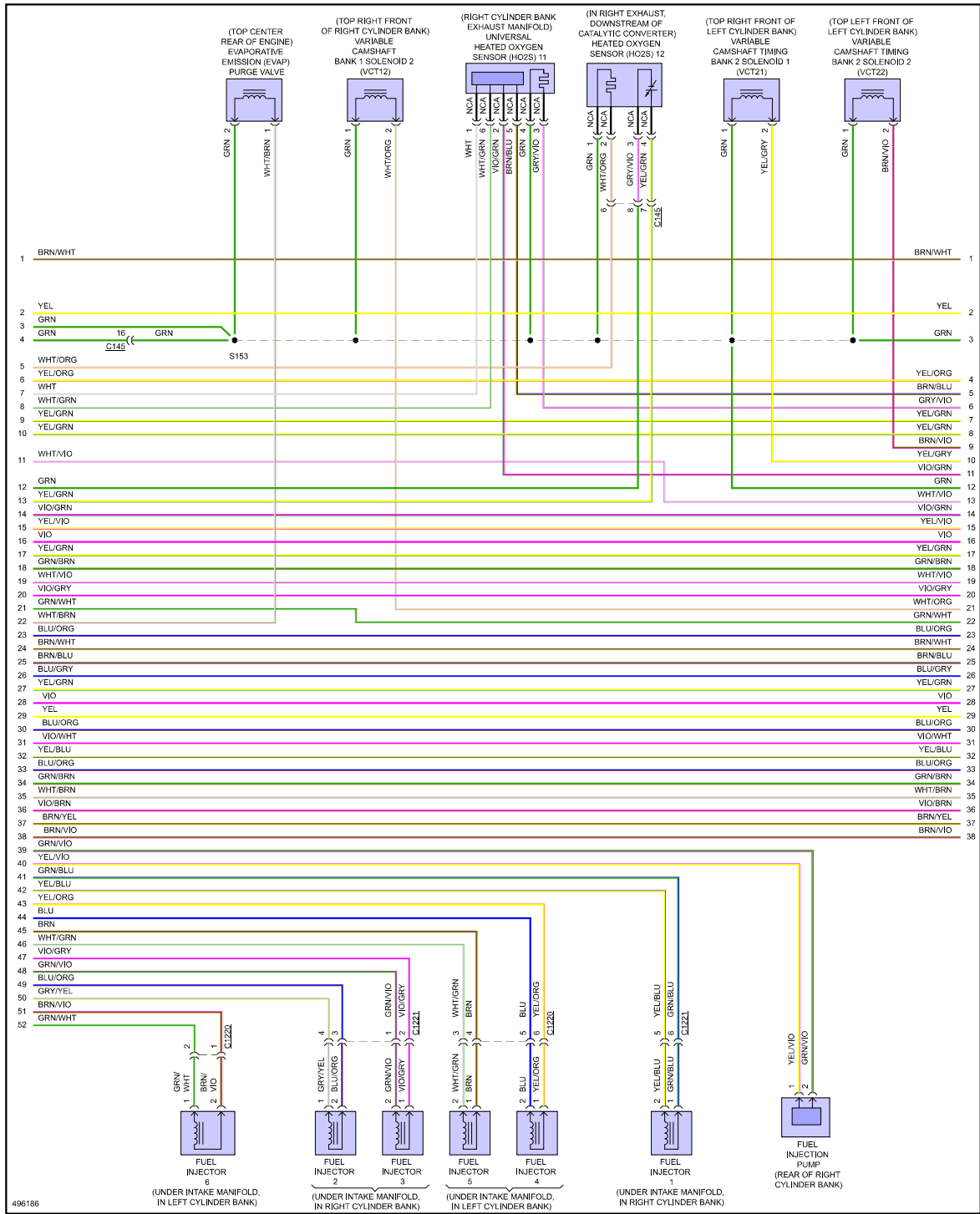
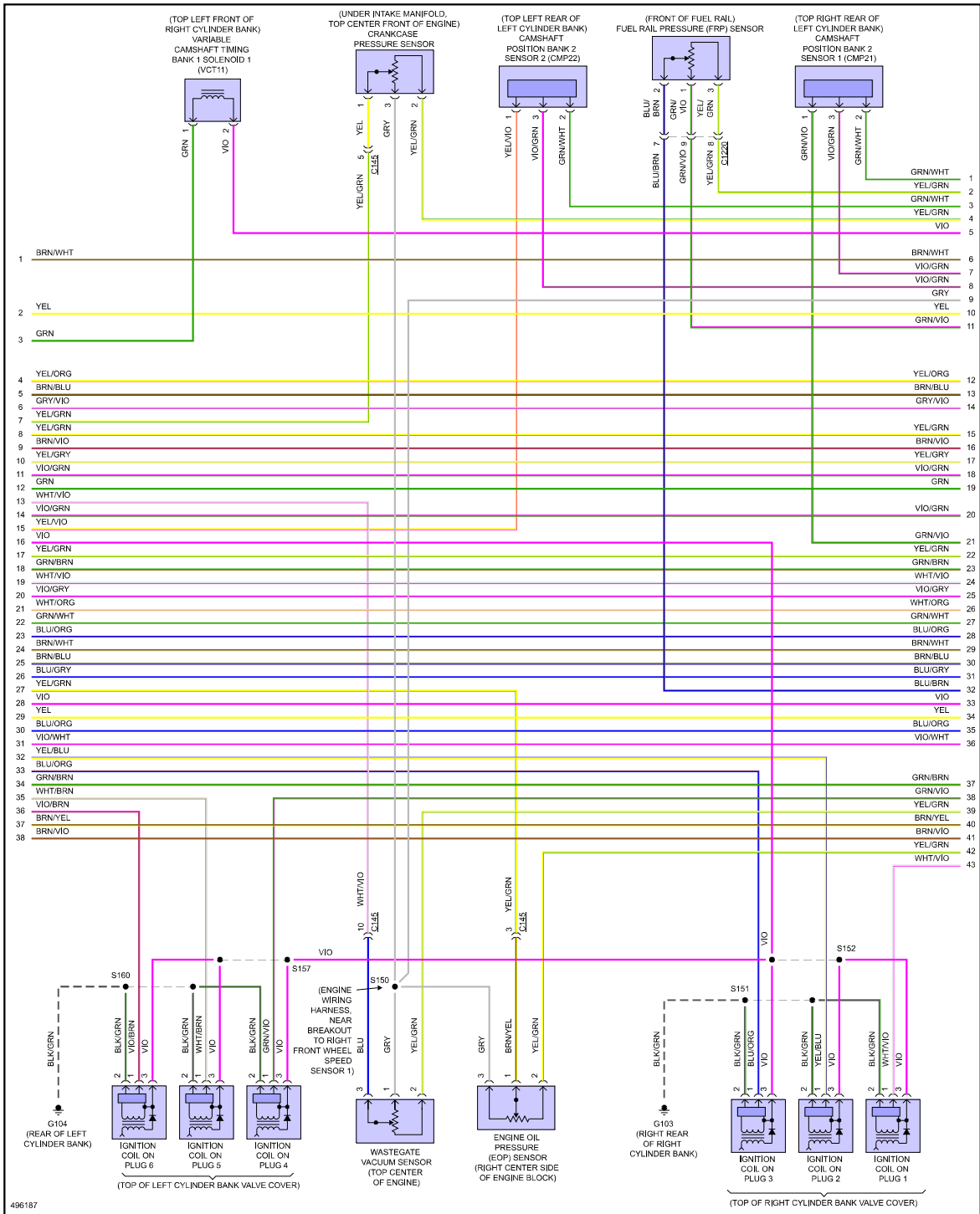

Fig 8: 2.7L Turbo, Engine Performance Circuit (8 of 9)







# ENGINE PERFORMANCE > 3.5L

Fig 1: 3.5L, Engine Performance Circuit (1 of 7)

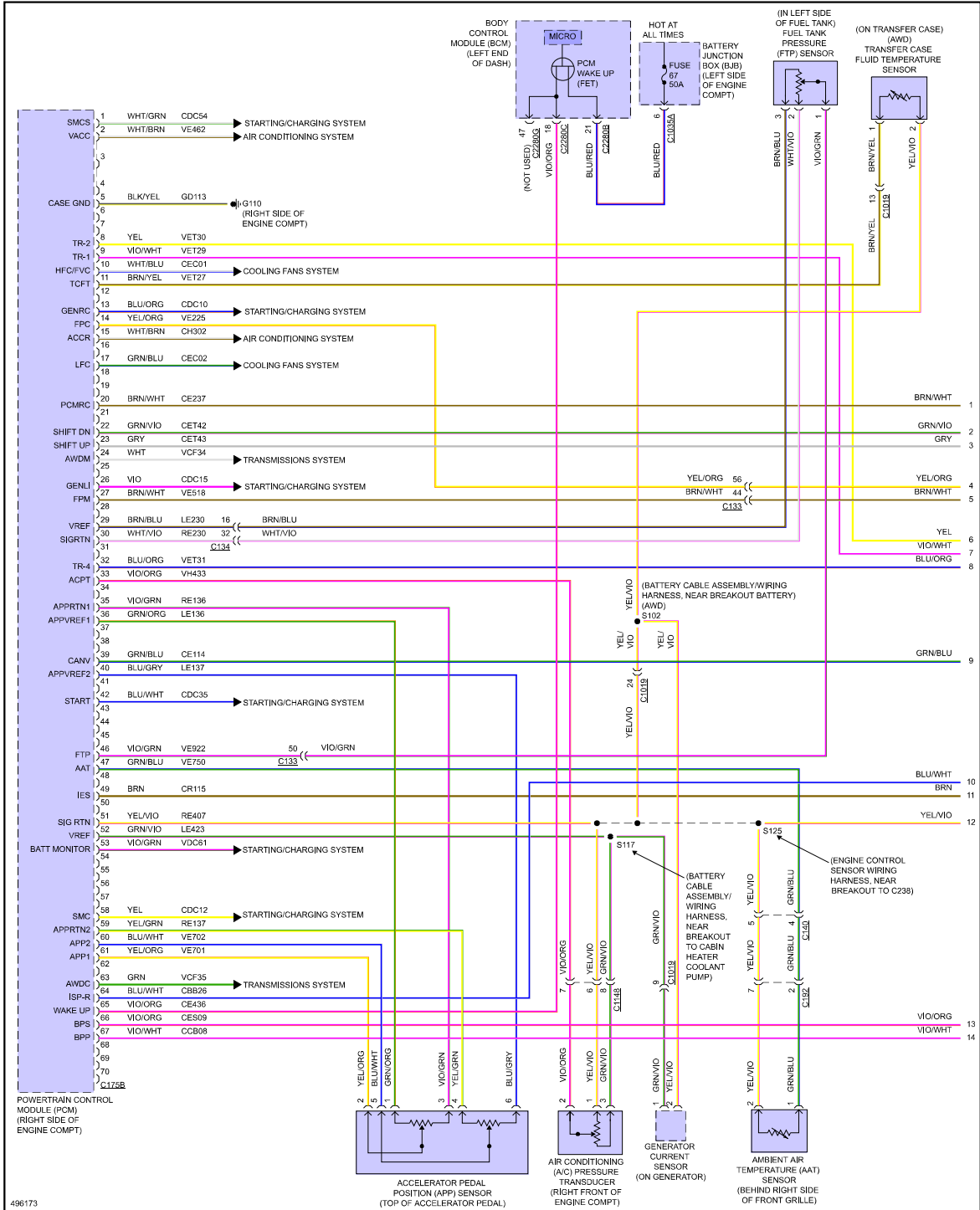

Fig 2: 3.5L, Engine Performance Circuit (2 of 7)

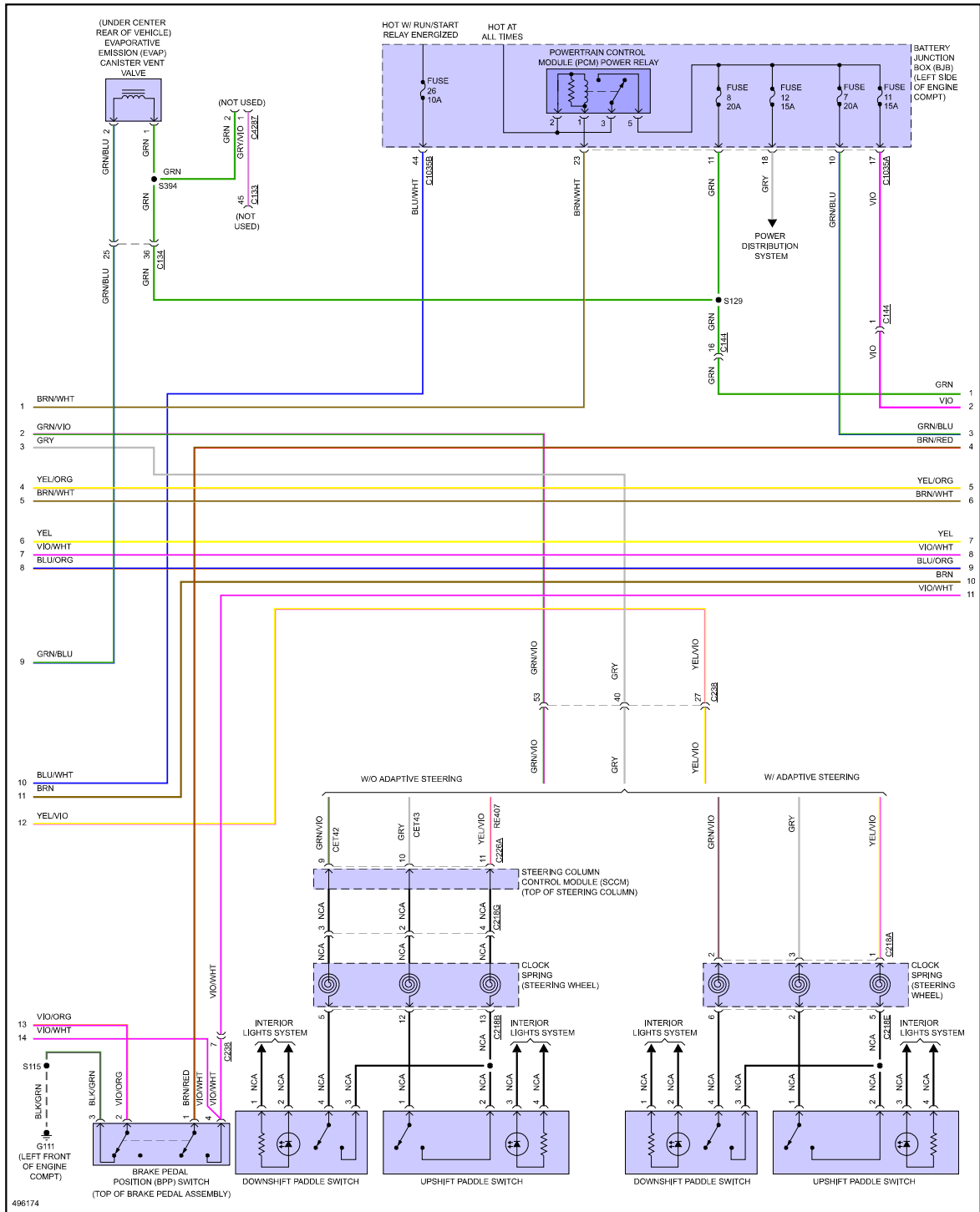
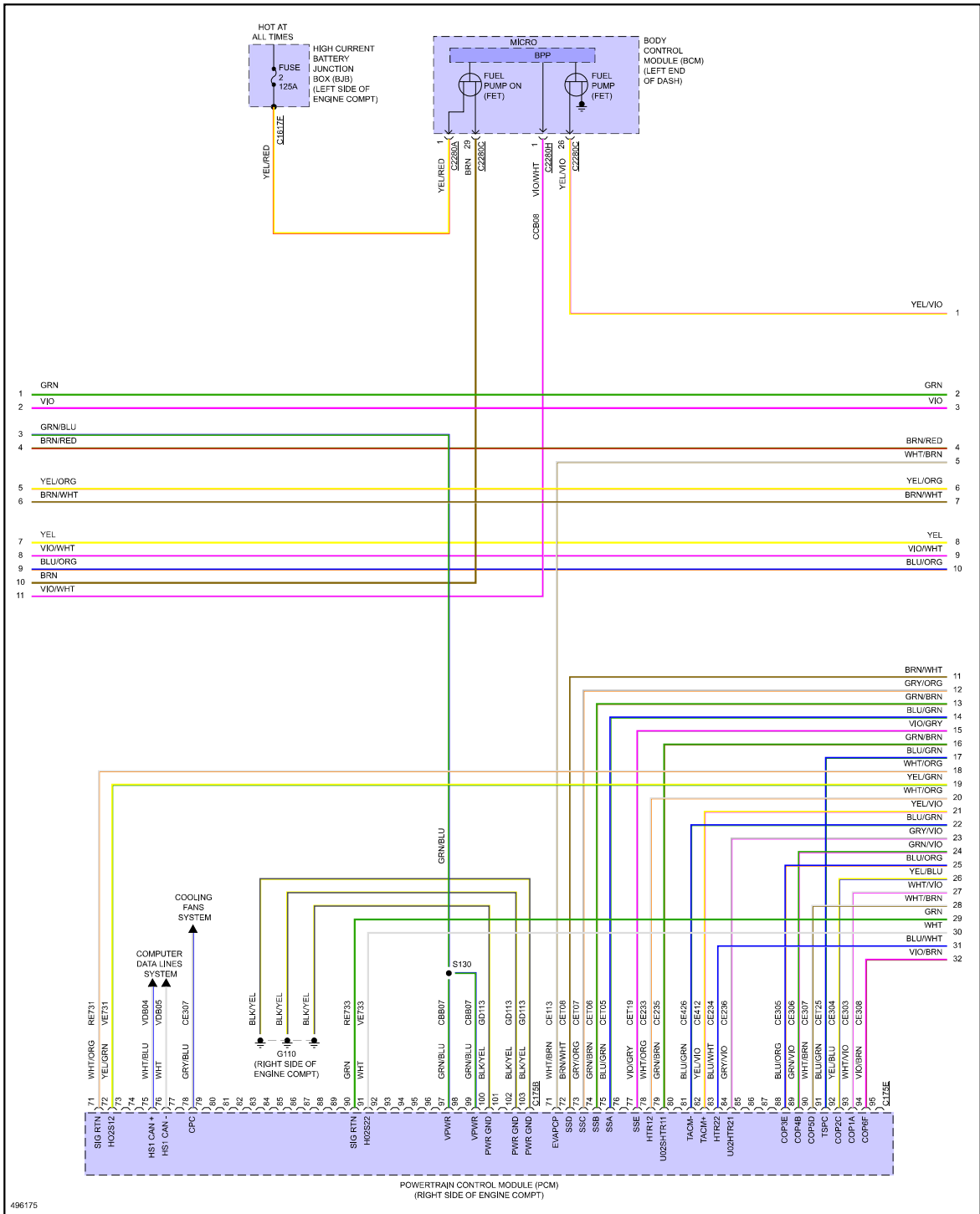

Fig 3: 3.5L, Engine Performance Circuit (3 of 7)



496175



Fig 5: 3.5L, Engine Performance Circuit (5 of 7)

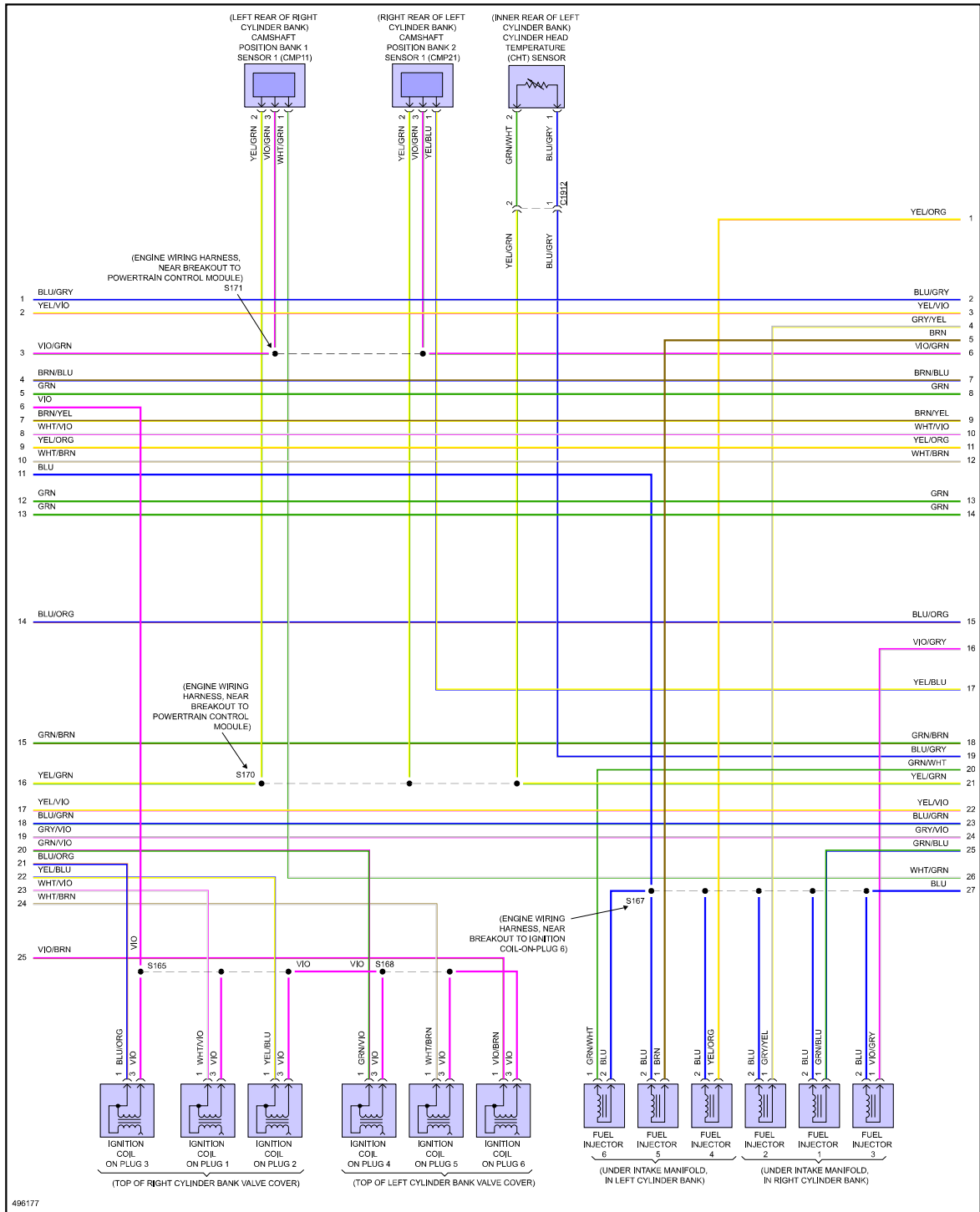

Fig 6: 3.5L, Engine Performance Circuit (6 of 7)

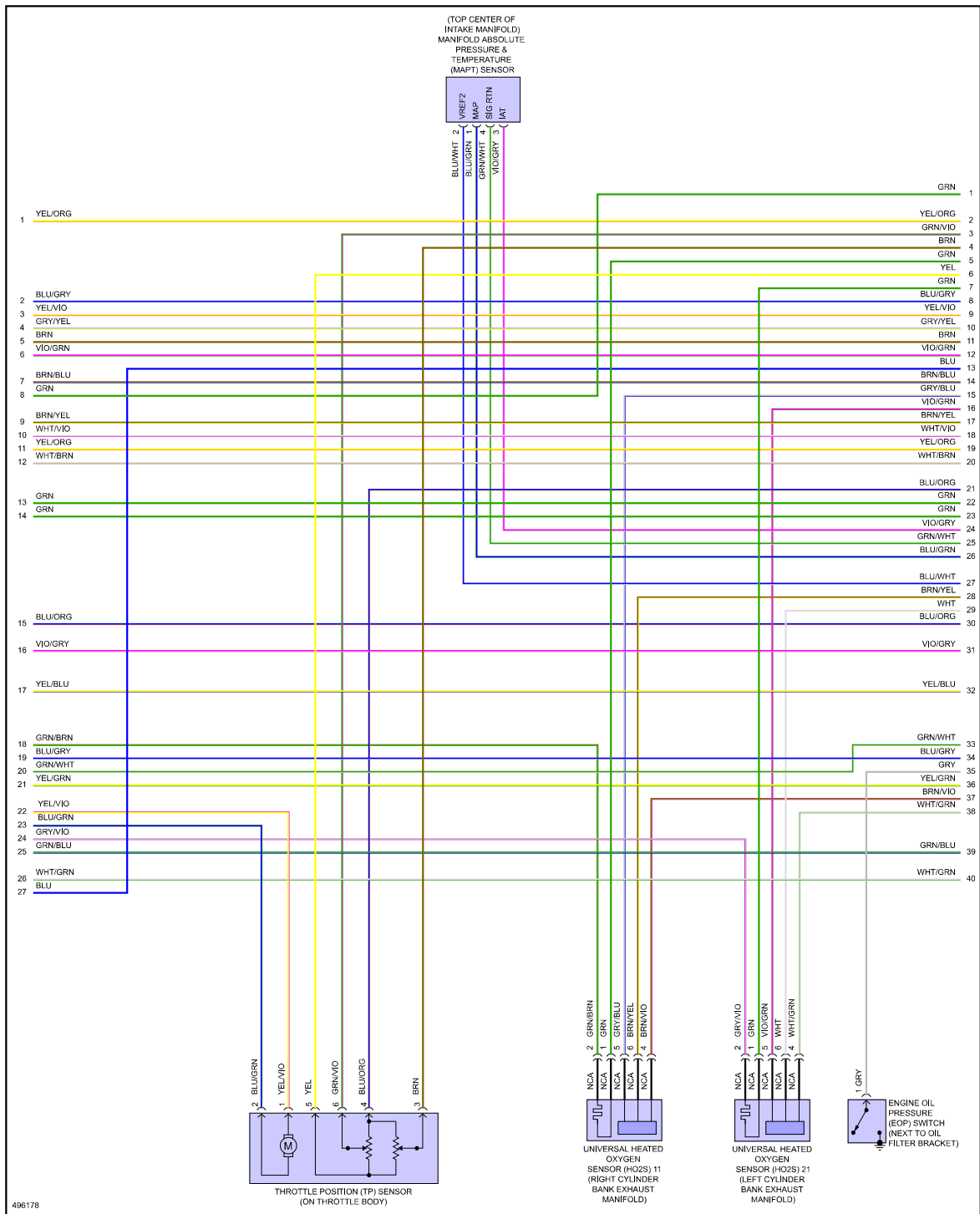

Fig 7: 3.5L, Engine Performance Circuit (7 of 7)

