

YMMS: 2016 Ford Taurus SHO
 Engine: 3.5L Eng
 VIN:

Nov 8, 2022

License:
 Odometer:

ENGINE PERFORMANCE > 2.0L TURBO

Fig 1: 2.0L Turbo, Engine Performance Circuit (1 of 6)

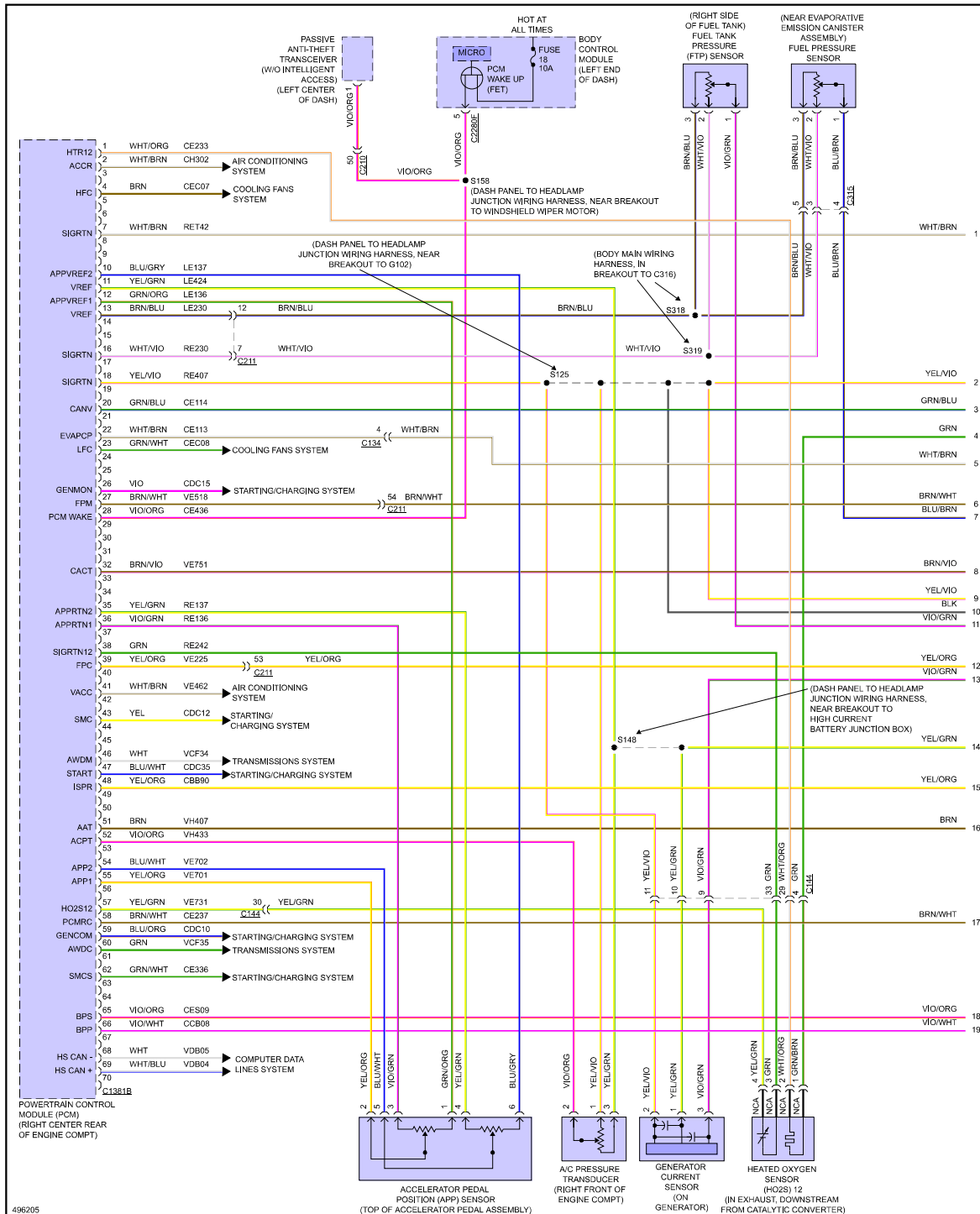

Fig 2: 2.0L Turbo, Engine Performance Circuit (2 of 6)

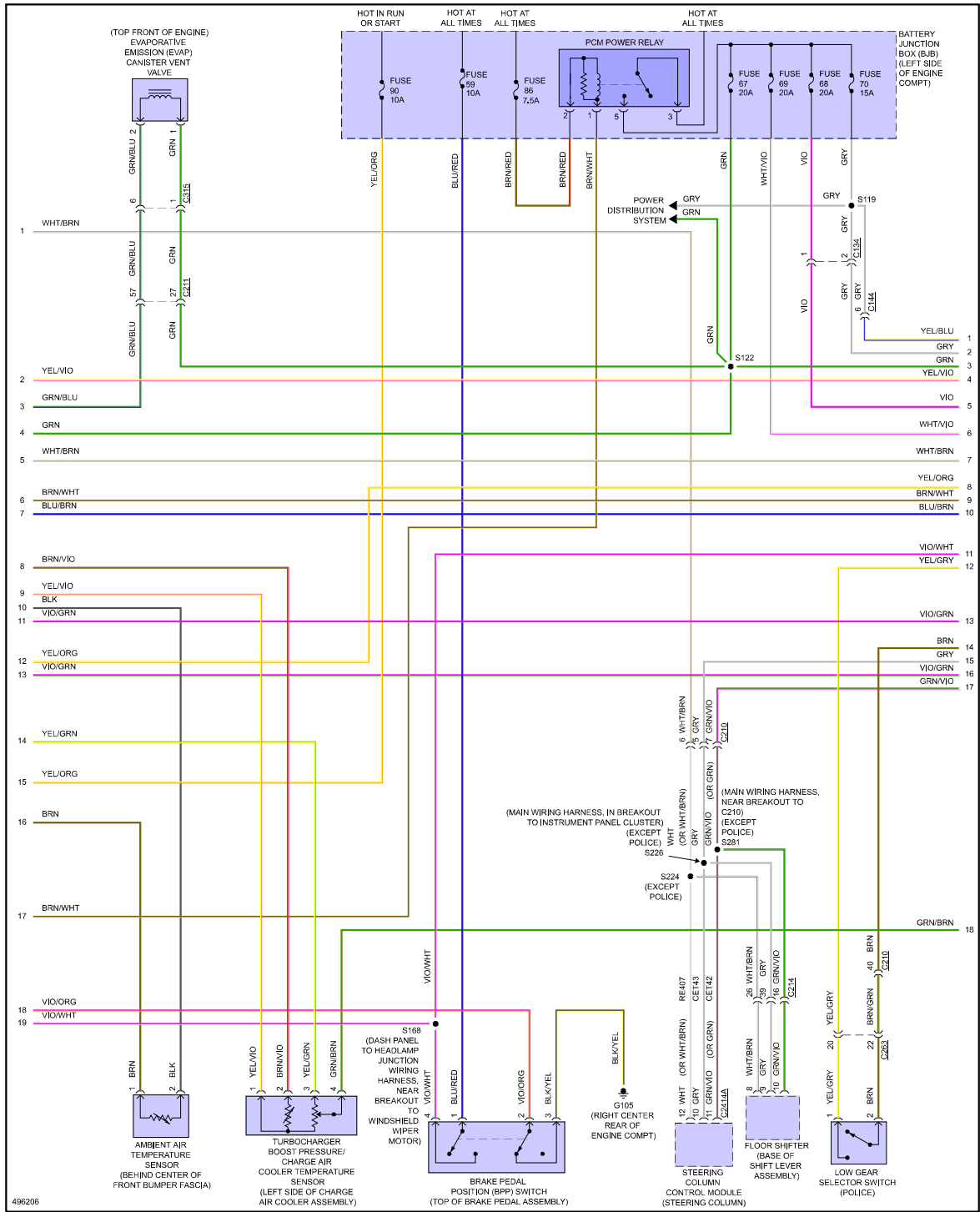

Fig 3: 2.0L Turbo, Engine Performance Circuit (3 of 6)

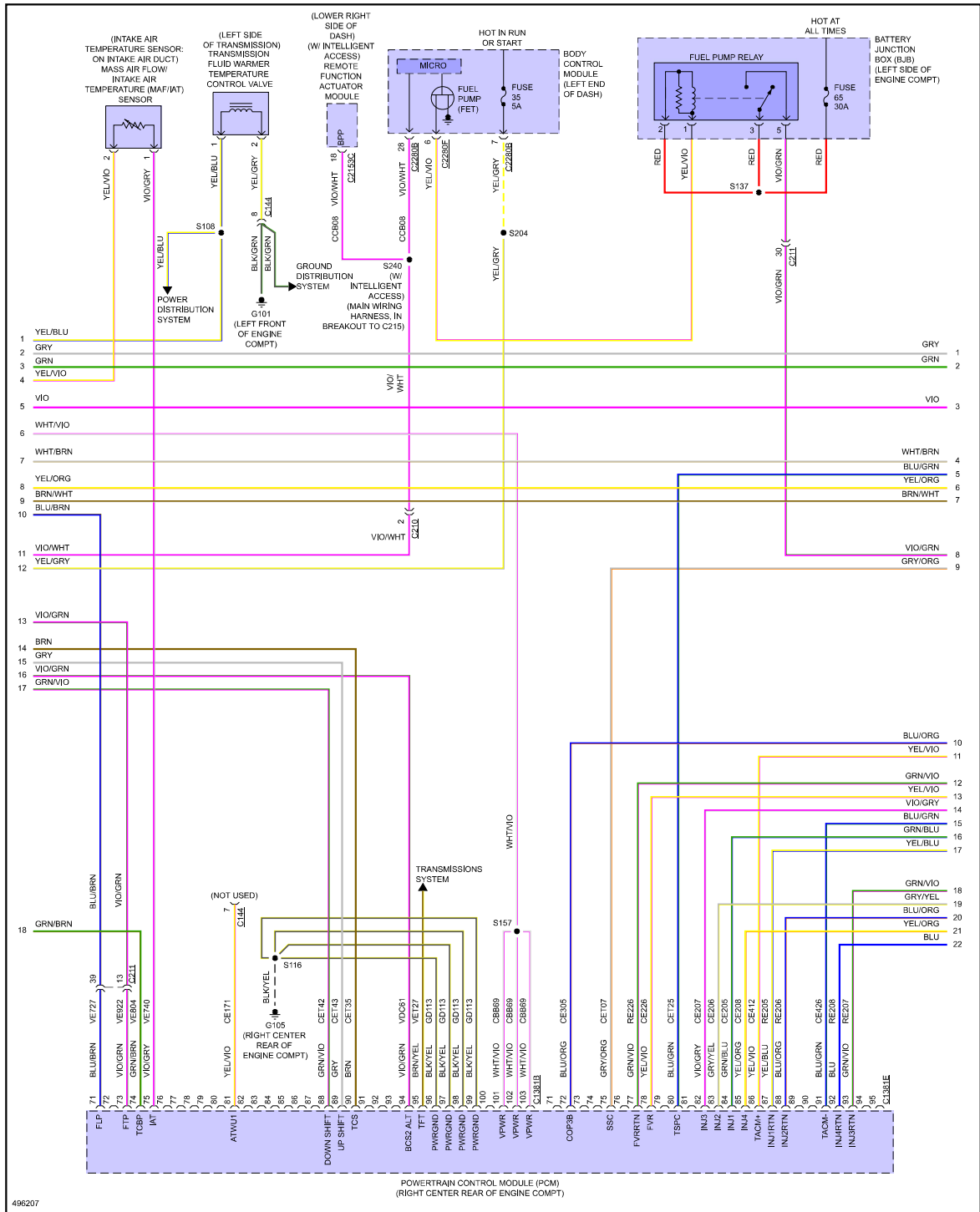

Fig 4: 2.0L Turbo, Engine Performance Circuit (4 of 6)

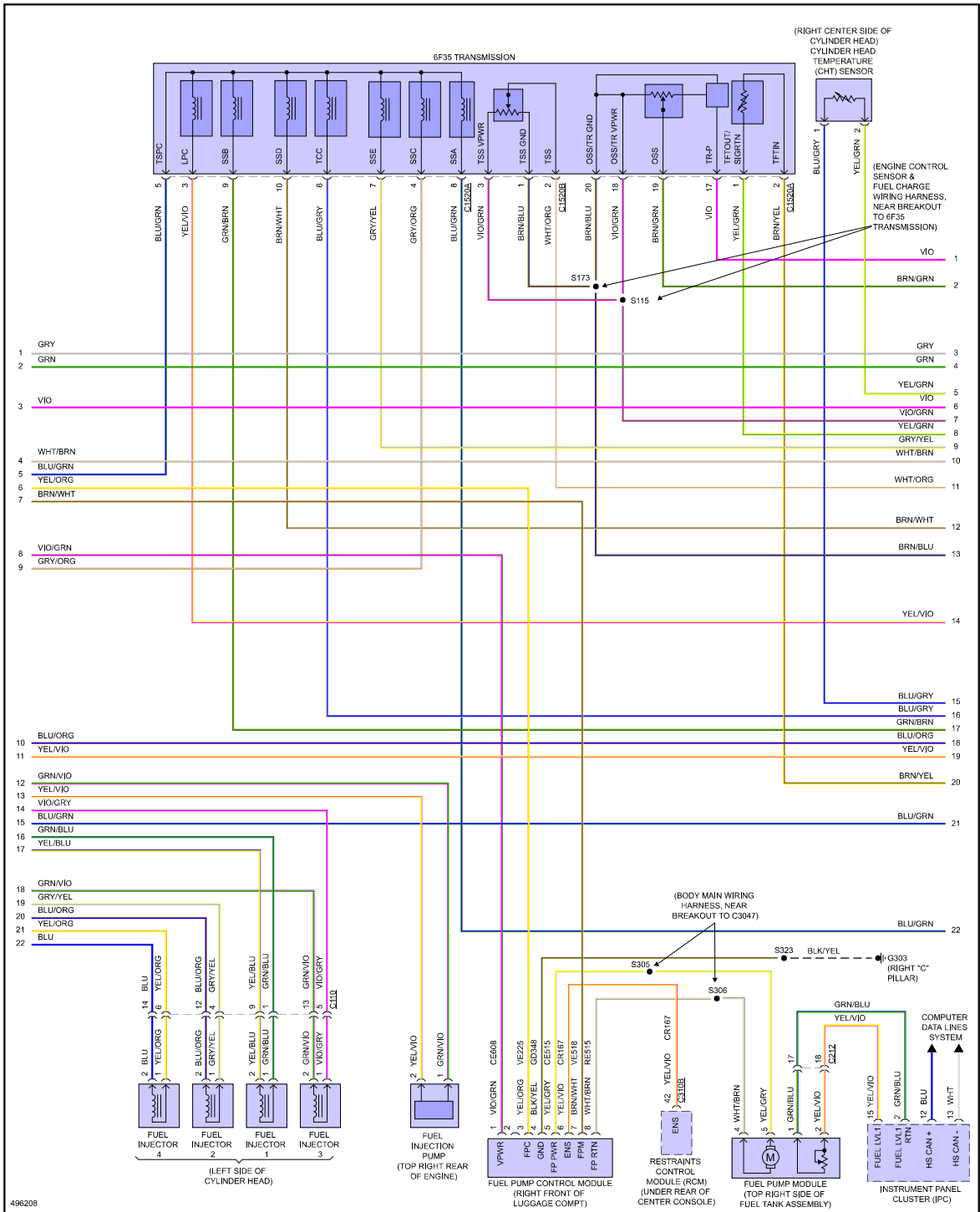

Fig 5: 2.0L Turbo, Engine Performance Circuit (5 of 6)

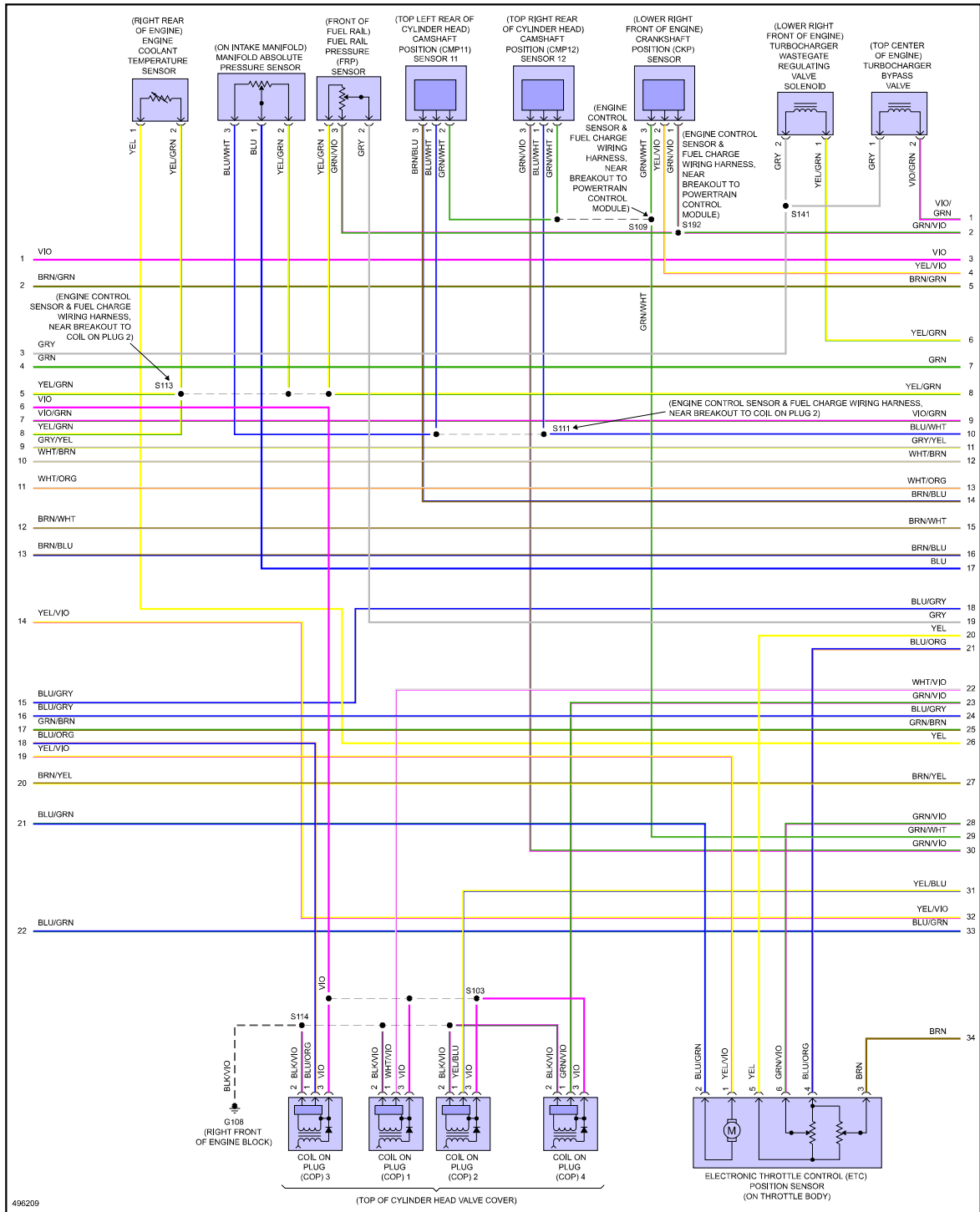
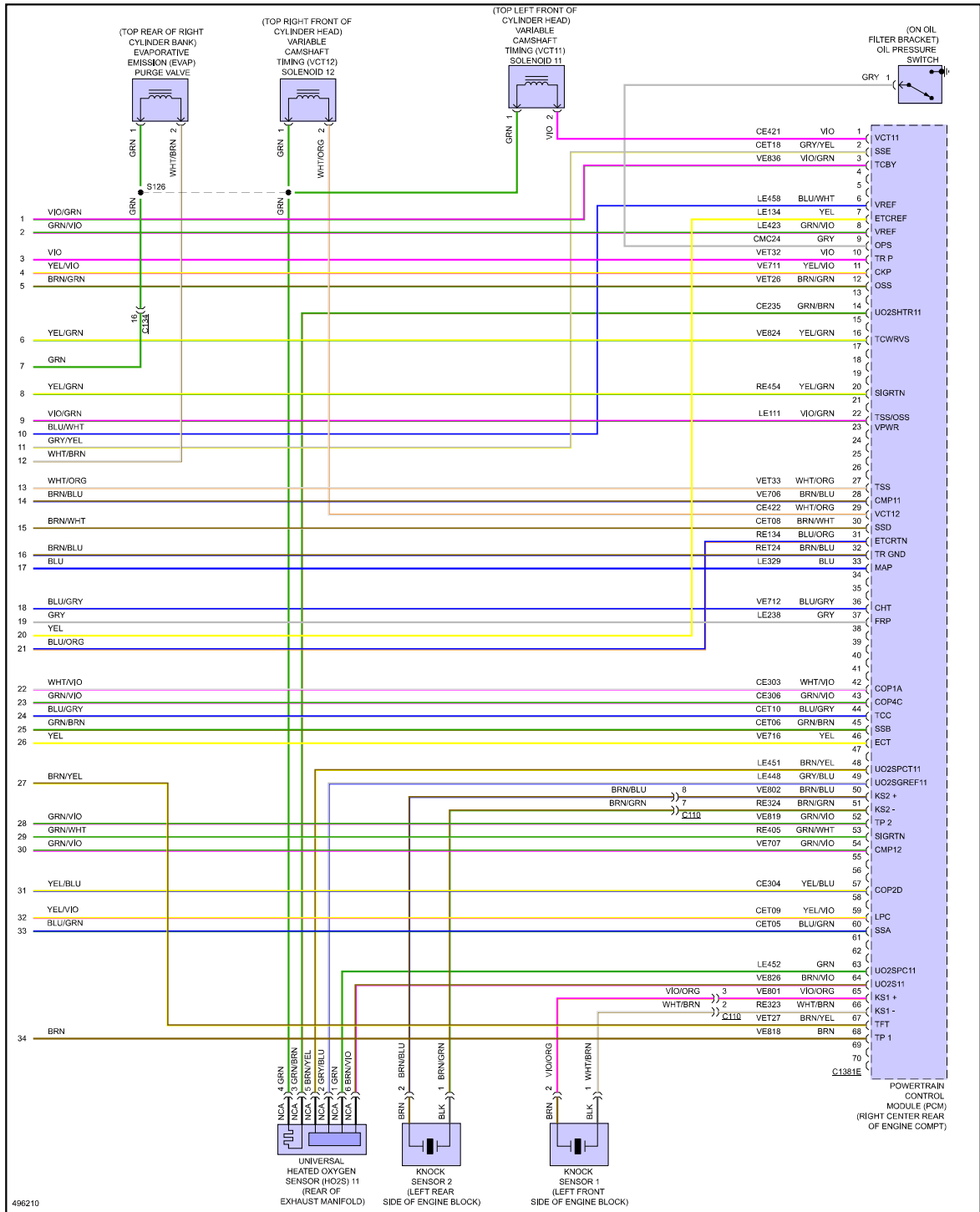

Fig 6: 2.0L Turbo, Engine Performance Circuit (6 of 6)



ENGINE PERFORMANCE > 3.5L

Fig 1: 3.5L, Engine Performance Circuit (1 of 6)

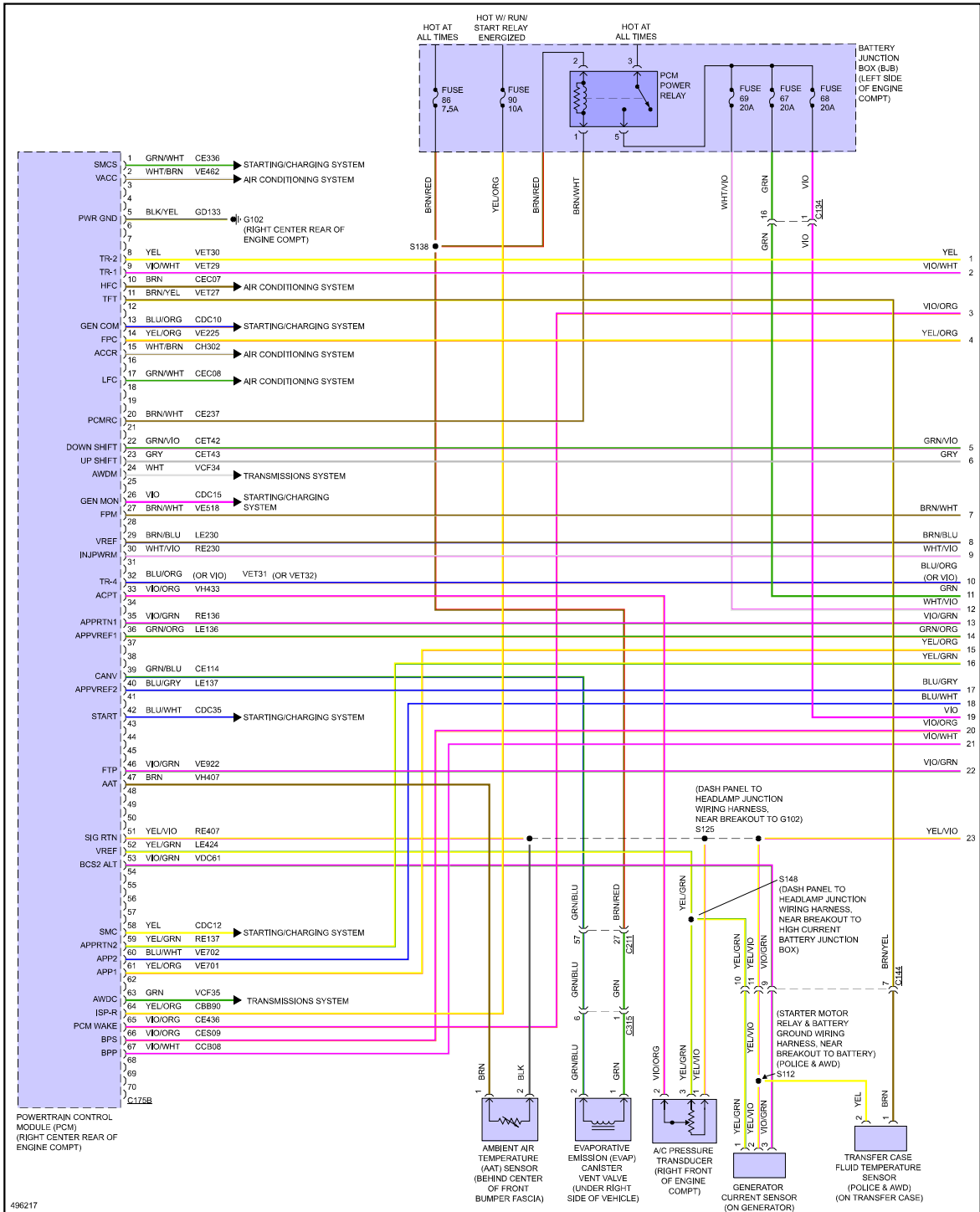

Fig 2: 3.5L, Engine Performance Circuit (2 of 6)

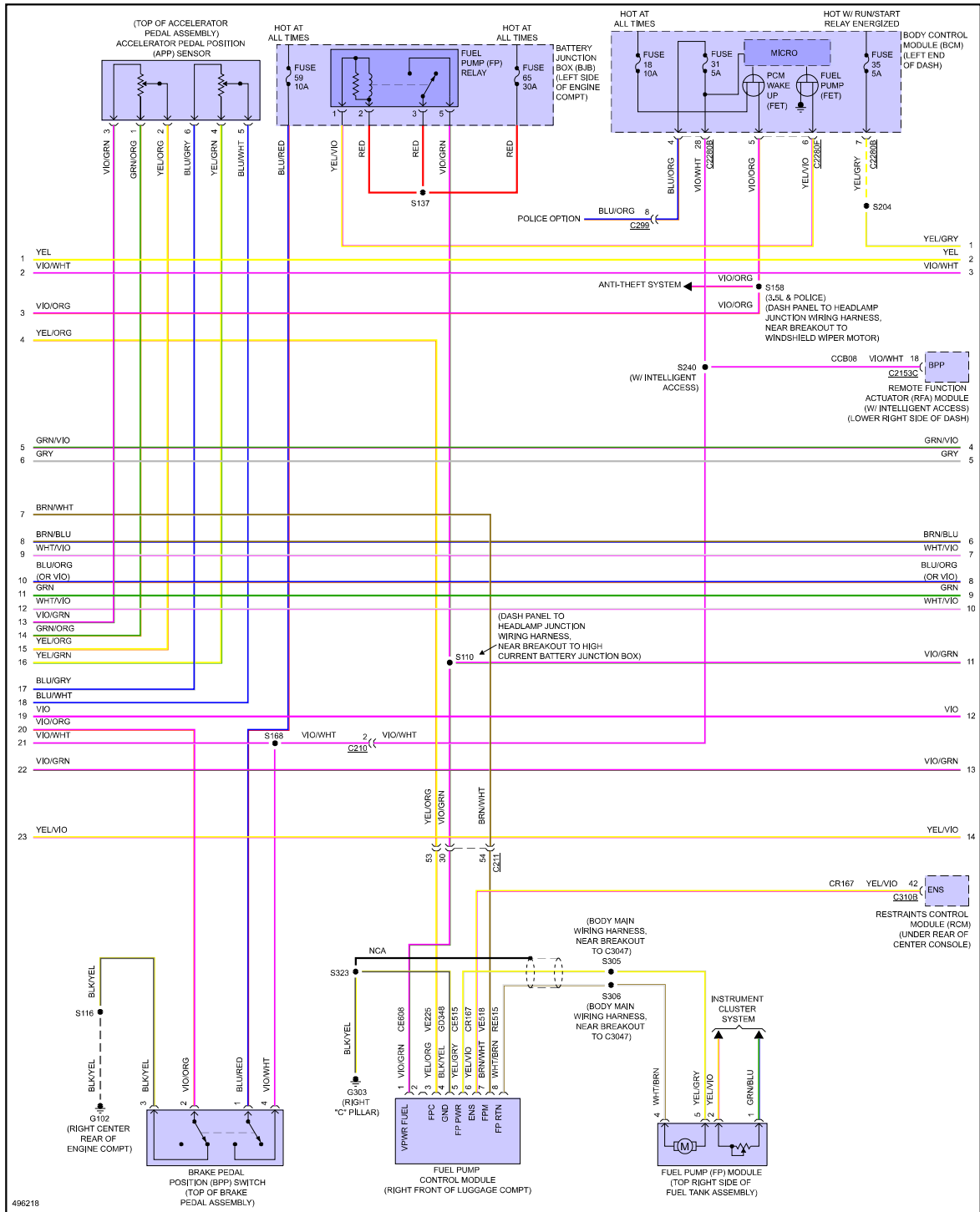

Fig 3: 3.5L, Engine Performance Circuit (3 of 6)

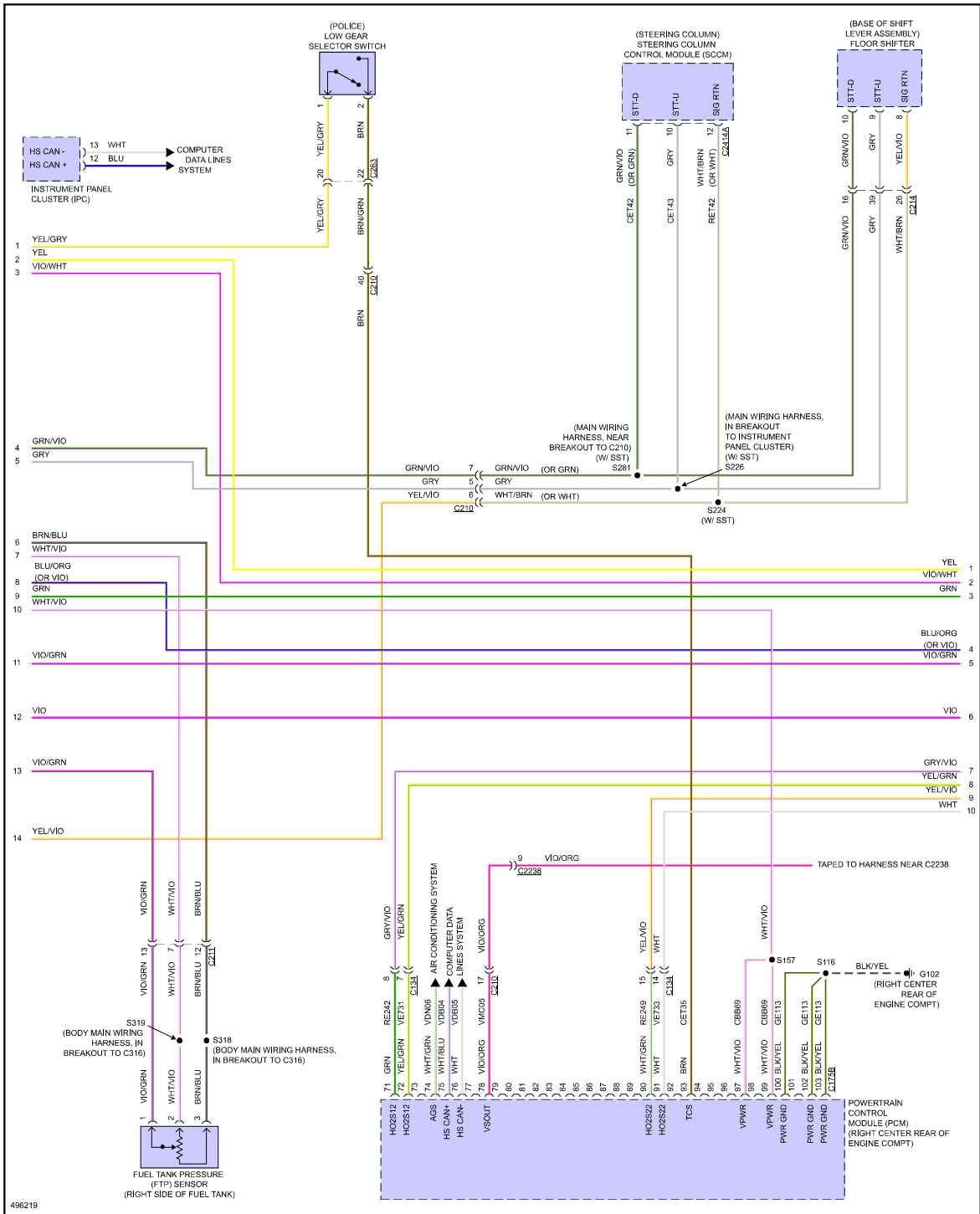

Fig 4: 3.5L, Engine Performance Circuit (4 of 6)

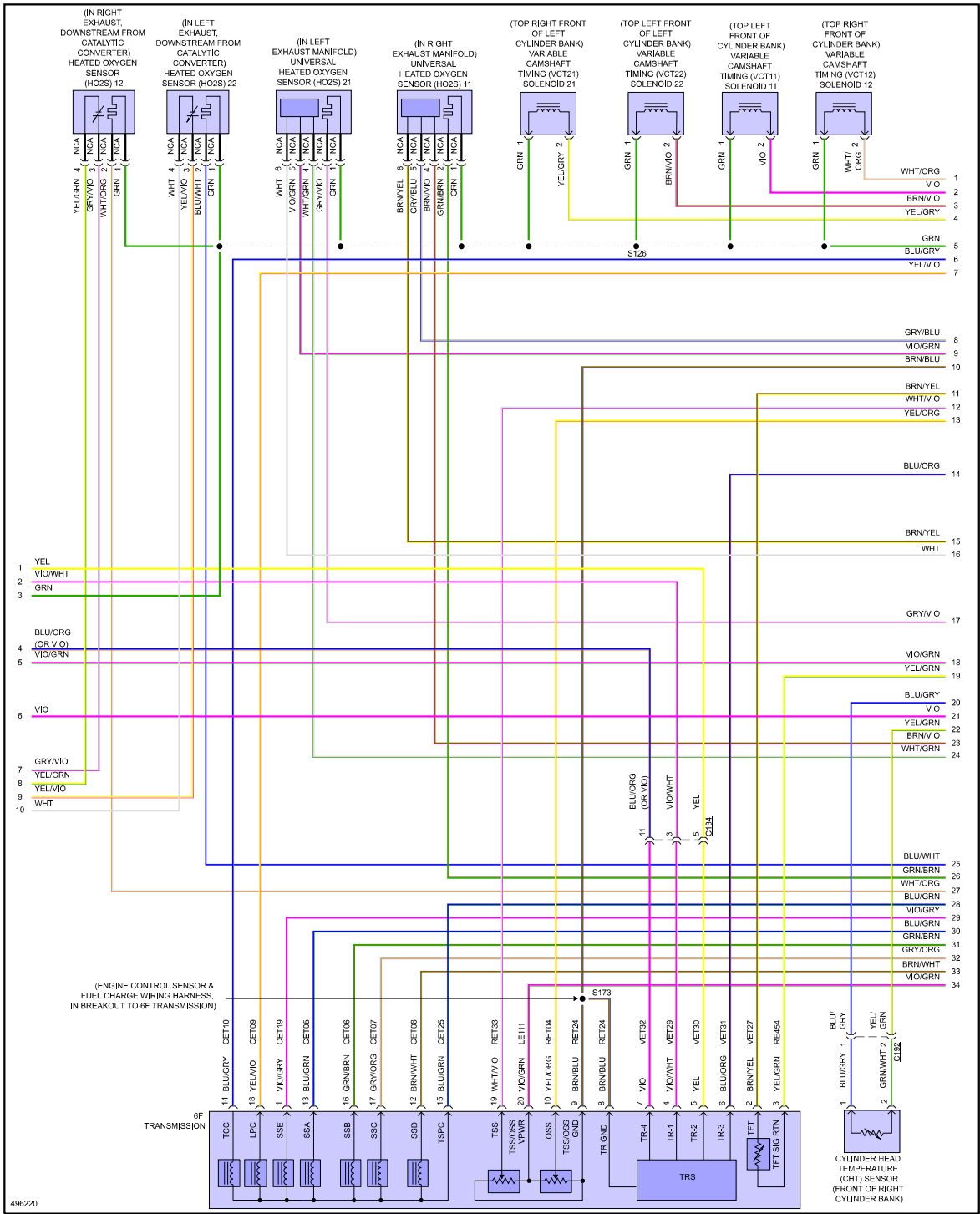

Fig 5: 3.5L, Engine Performance Circuit (5 of 6)

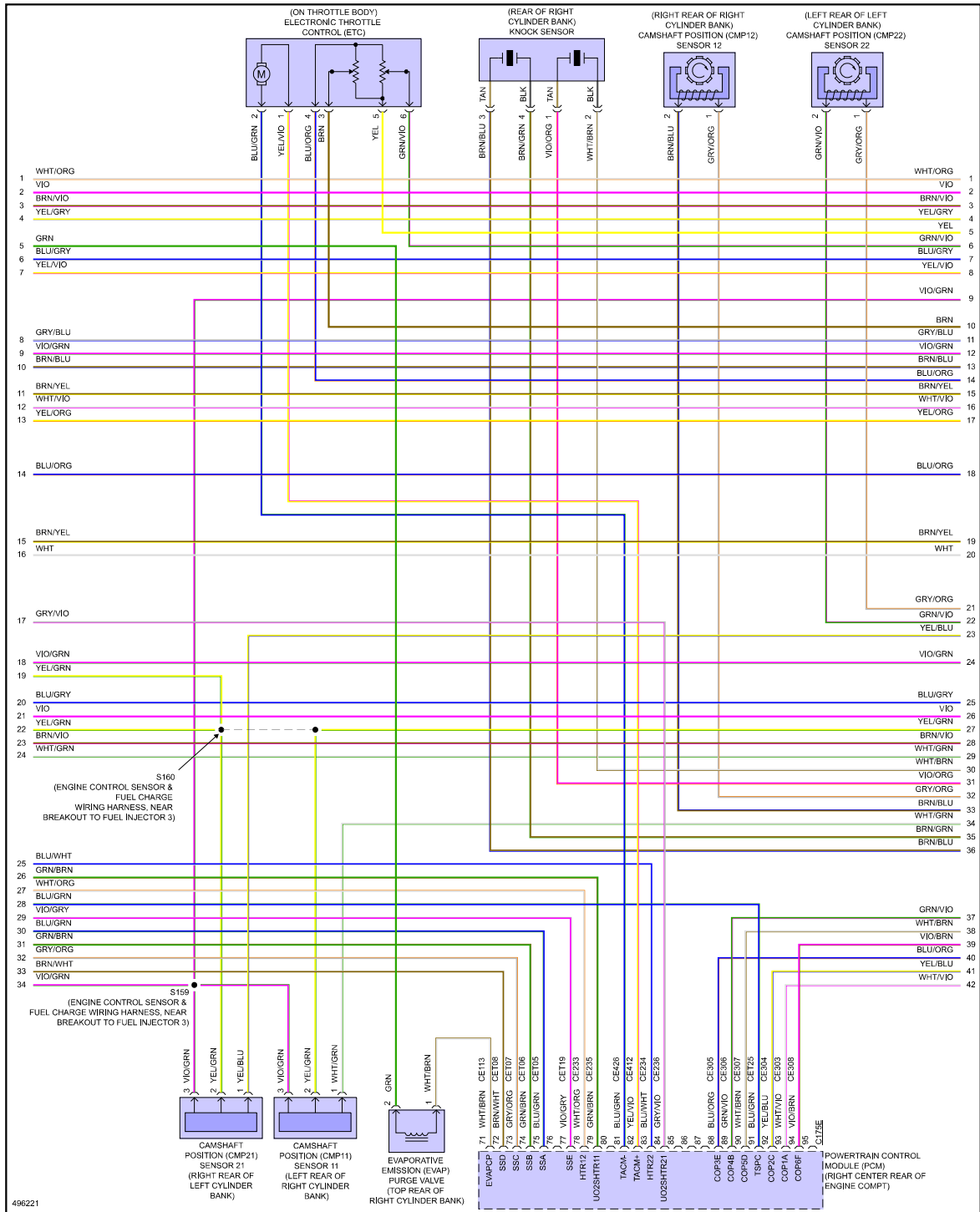
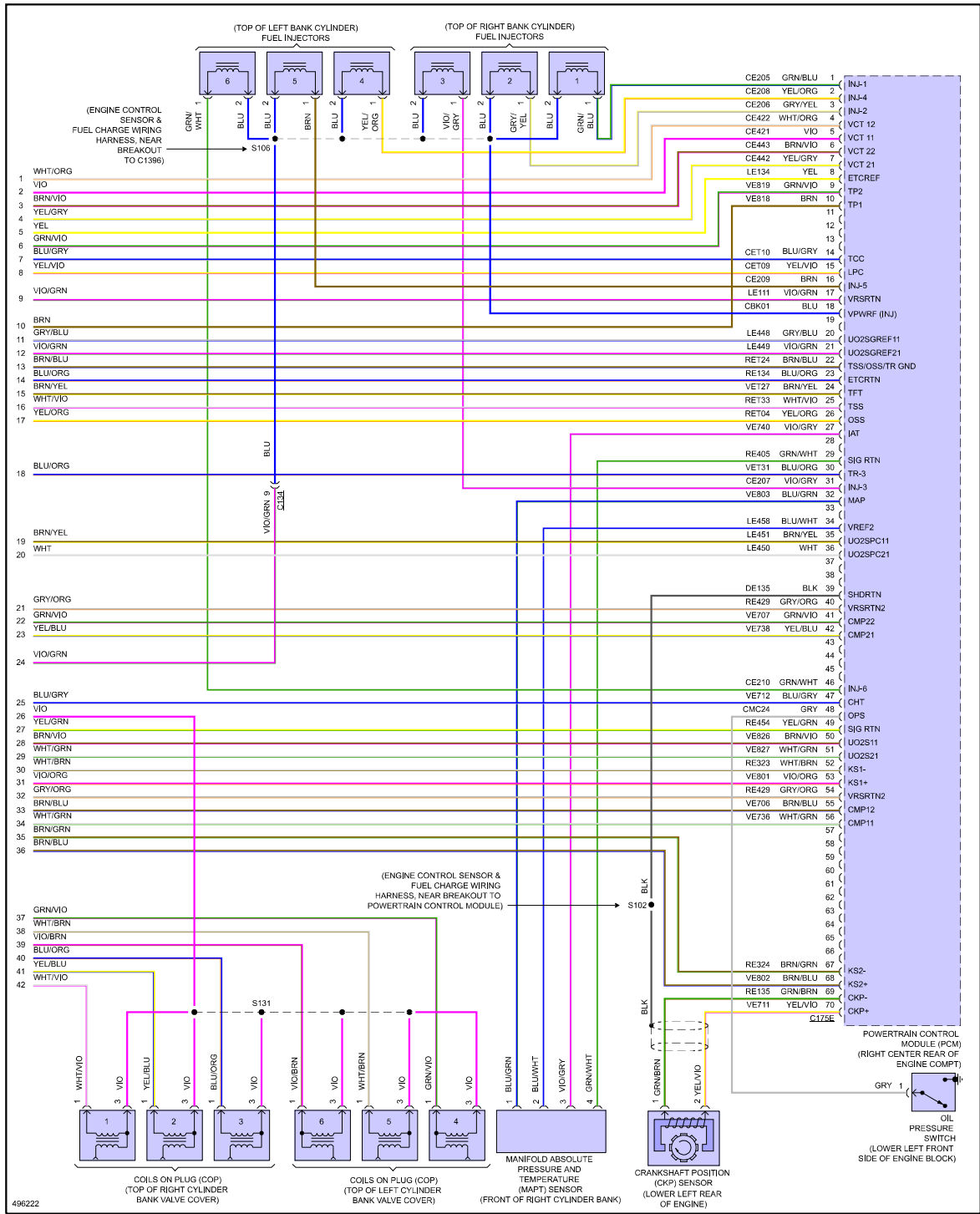

Fig 6: 3.5L, Engine Performance Circuit (6 of 6)



ENGINE PERFORMANCE > 3.5L TWIN TURBO

Fig 1: 3.5L Twin Turbo, Engine Performance Circuit (1 of 6)

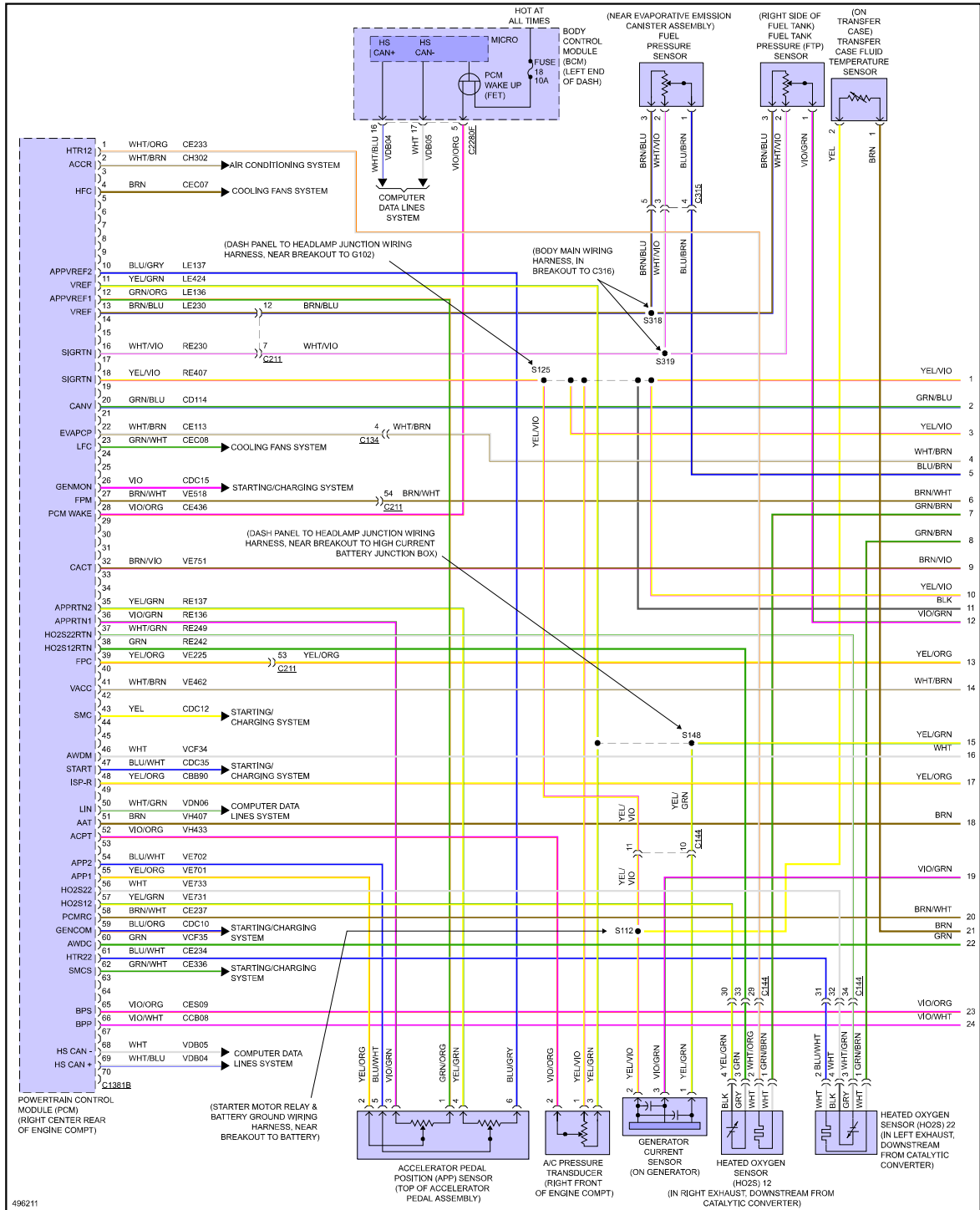

Fig 2: 3.5L Twin Turbo, Engine Performance Circuit (2 of 6)

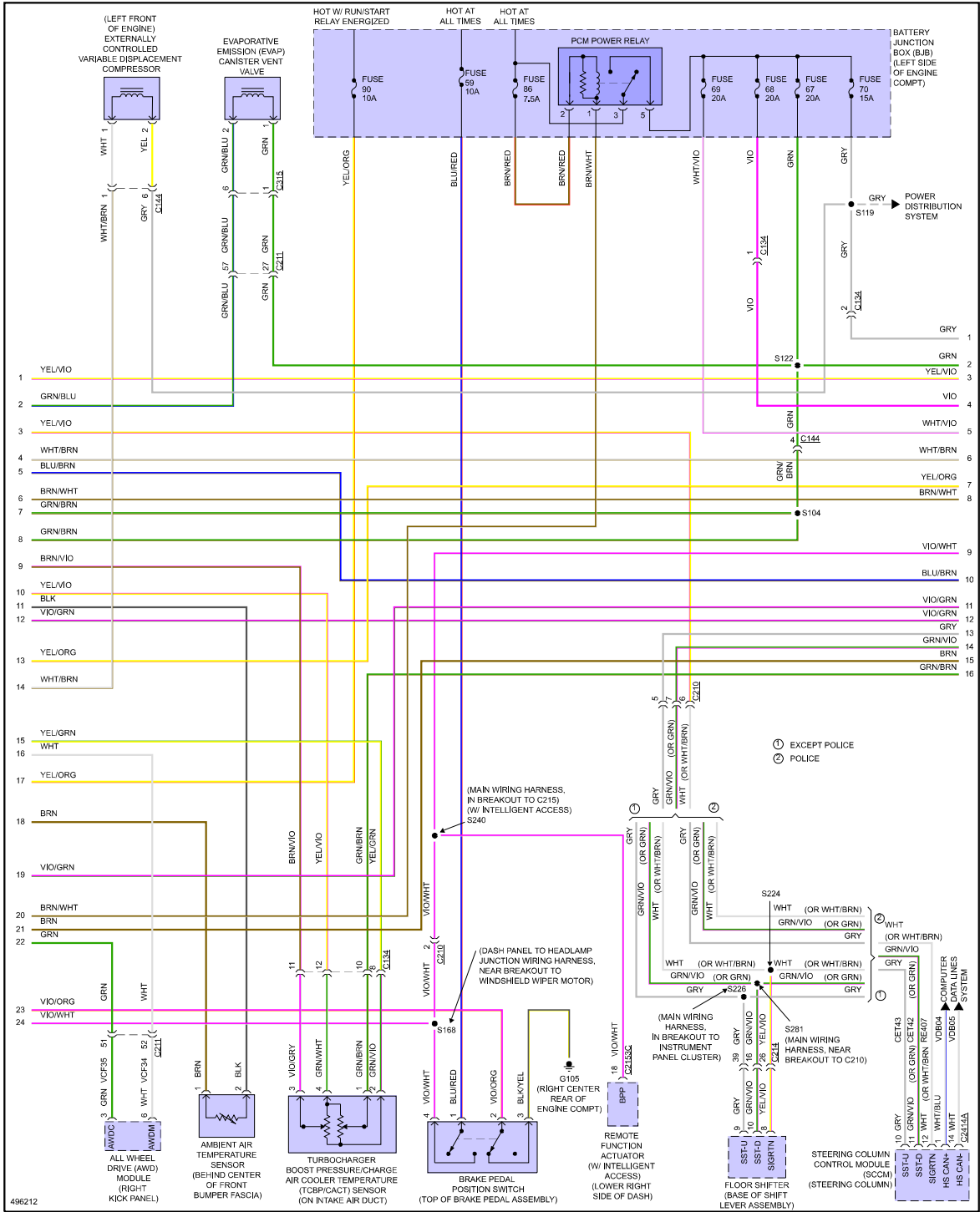

Fig 5: 3.5L Twin Turbo, Engine Performance Circuit (5 of 6)

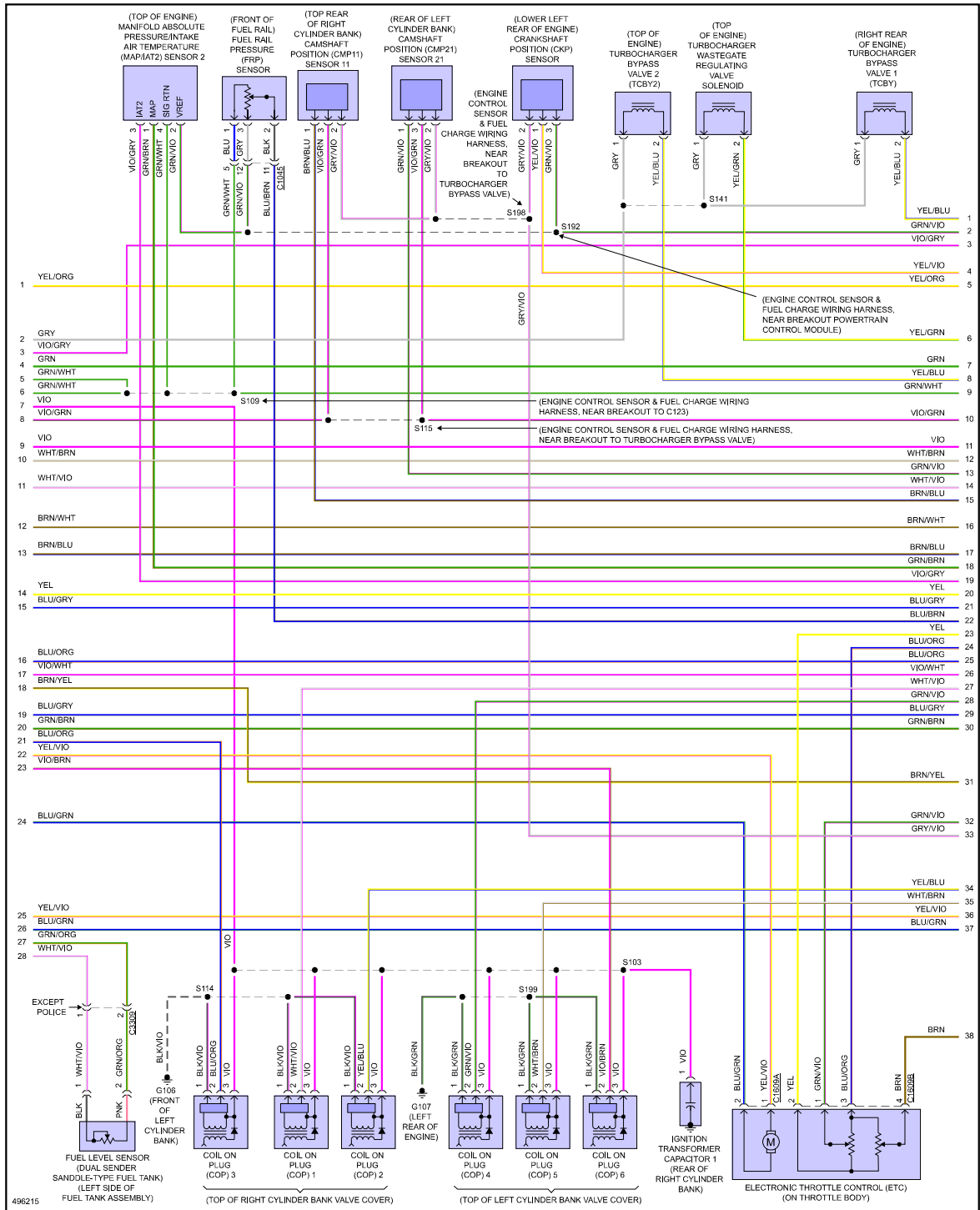

Fig 6: 3.5L Twin Turbo, Engine Performance Circuit (6 of 6)

