

## **P-Town Auto & Offroad, LLC**

688 Harshaw Ave.  
Patagonia, AZ 85624  
(520) 394-0181 T

YMMS: 2021 Honda Civic Type R

Engine: 2.0L Eng

VIN:

May 20, 2024

License:

Odometer:

**ENGINE PERFORMANCE > 2.0L TURBO**

Fig 1: 2.0L Turbo, Engine Performance Circuit (1 of 7)

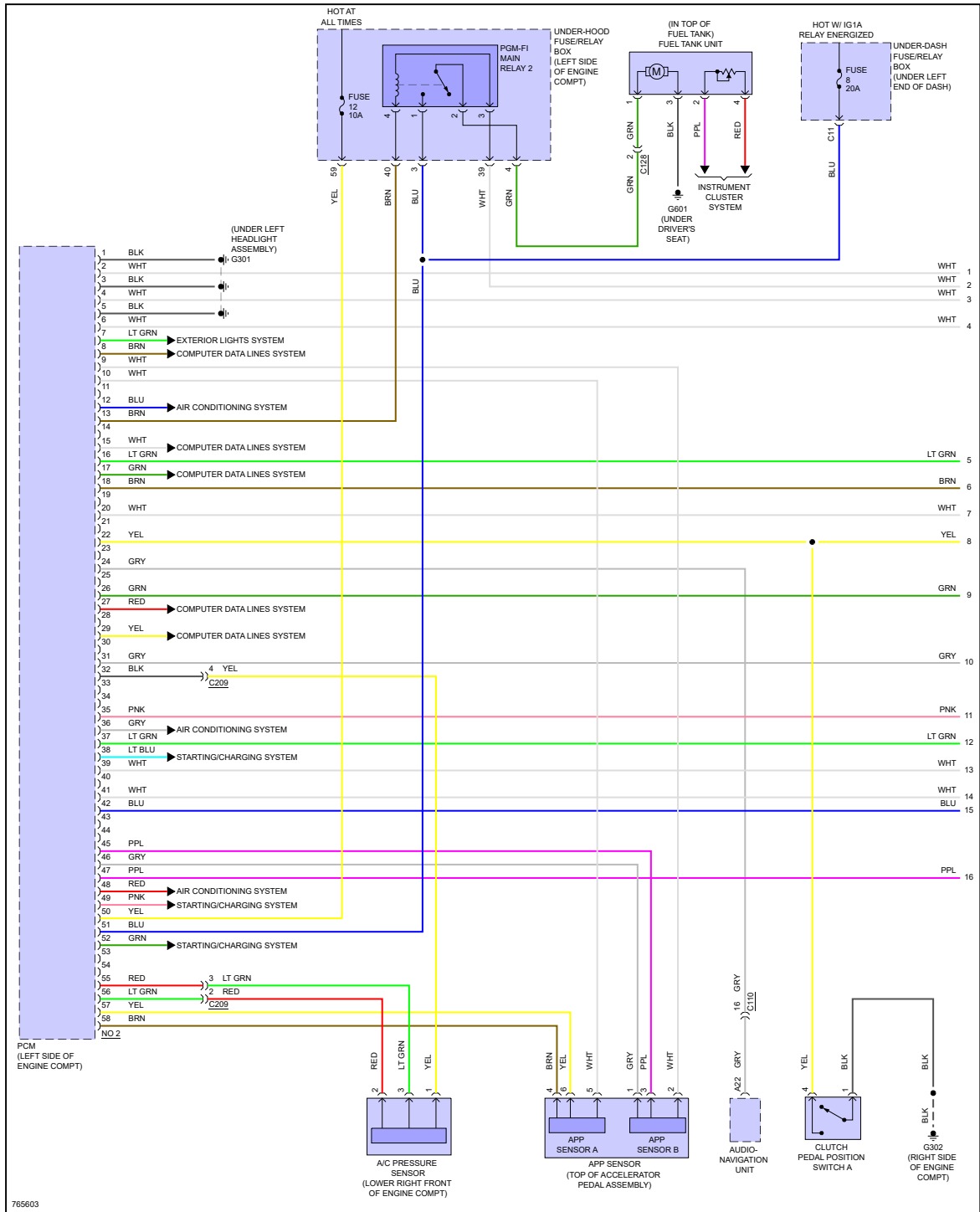

765603

Fig 2: 2.0L Turbo, Engine Performance Circuit (2 of 7)

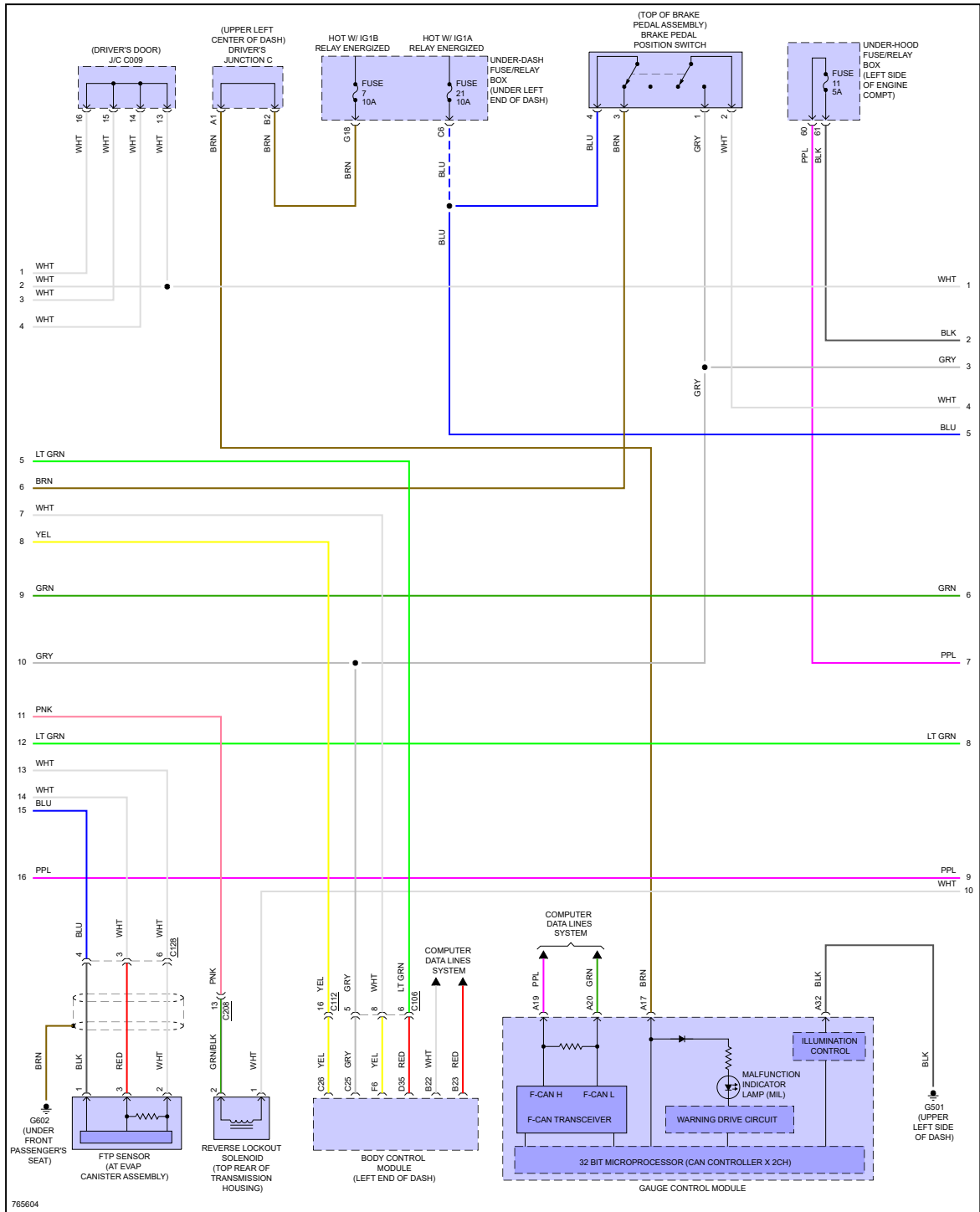

765604

Fig 3: 2.0L Turbo, Engine Performance Circuit (3 of 7)

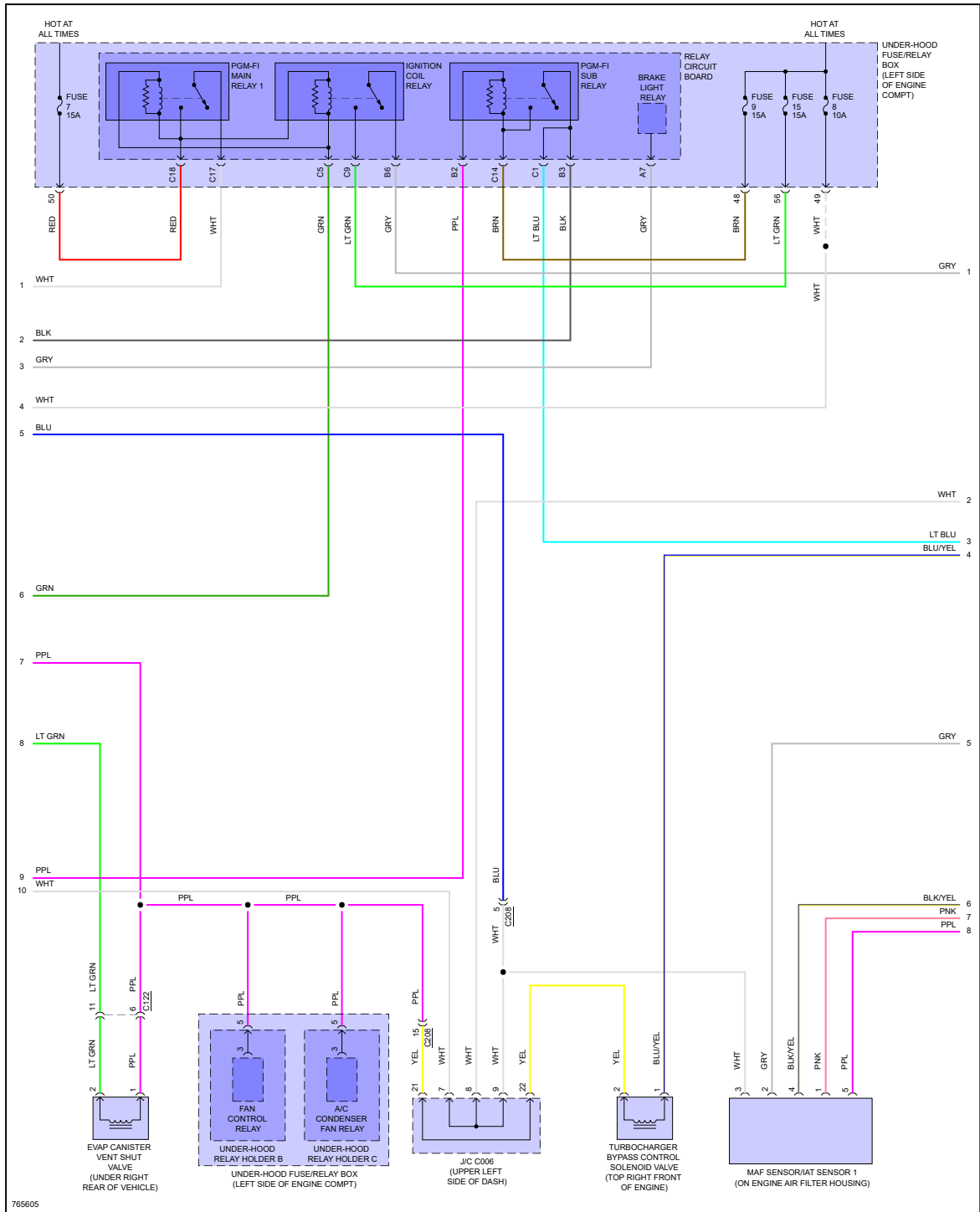

Fig 4: 2.0L Turbo, Engine Performance Circuit (4 of 7)

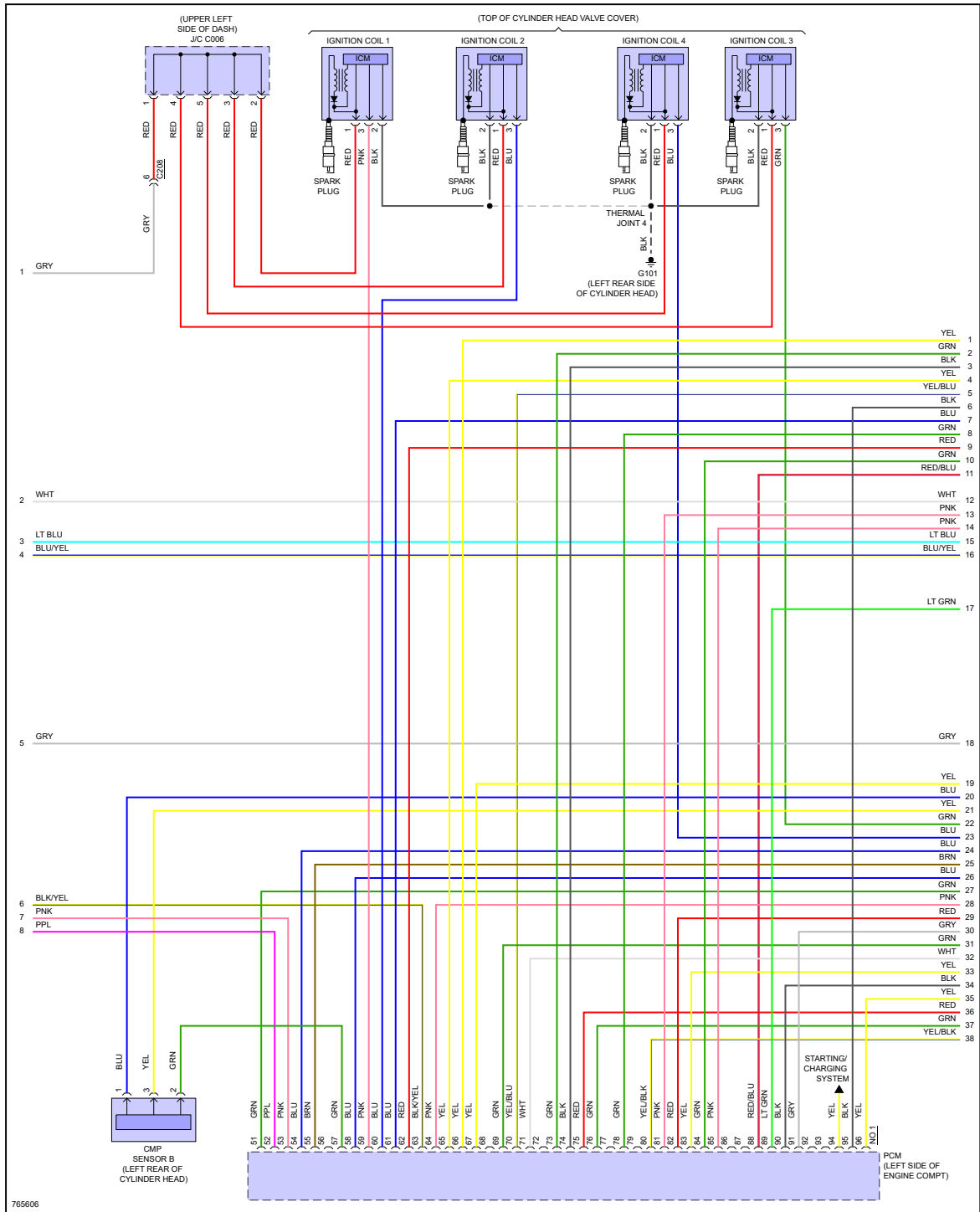
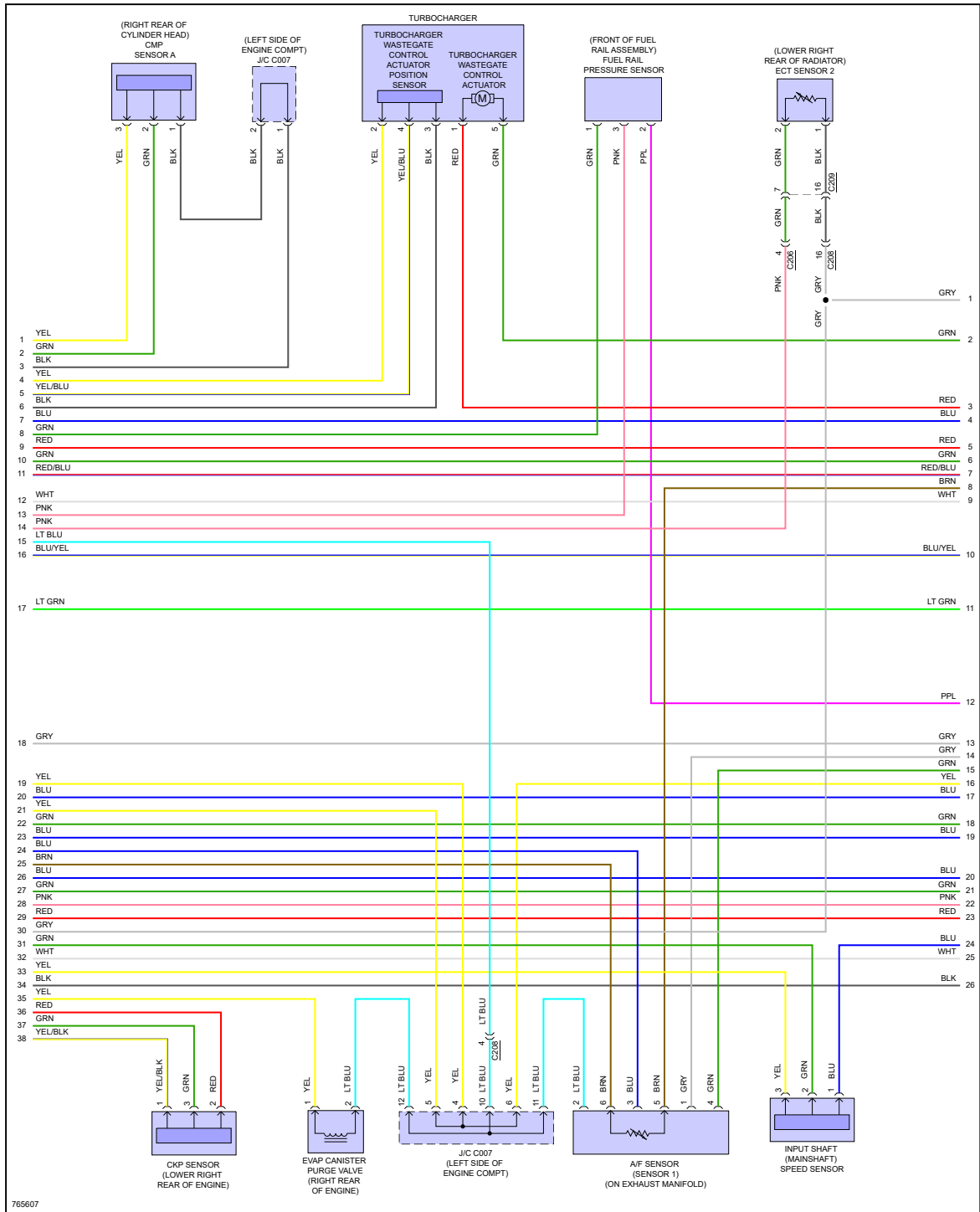

Fig 5: 2.0L Turbo, Engine Performance Circuit (5 of 7)



765607

Fig 6: 2.0L Turbo, Engine Performance Circuit (6 of 7)

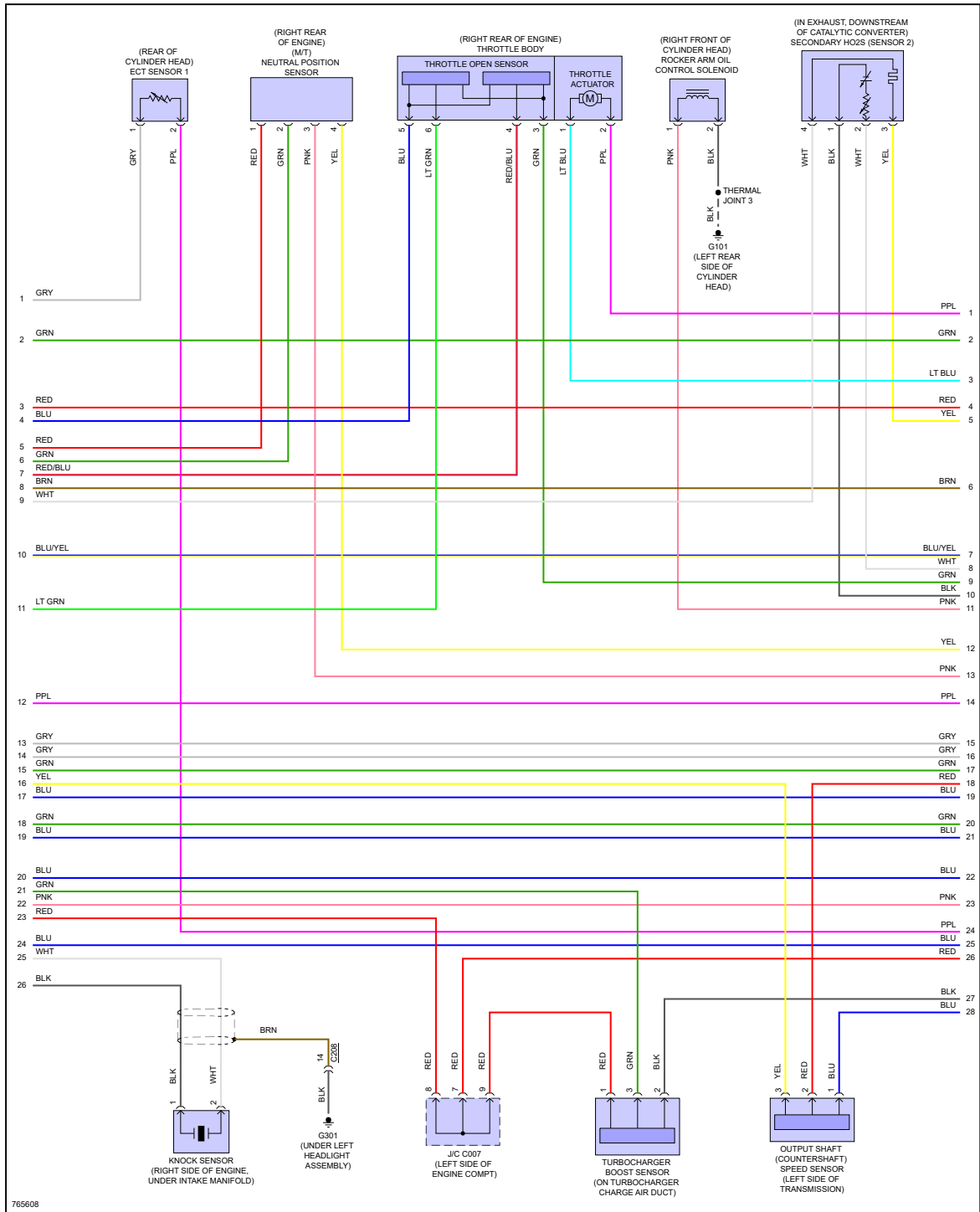
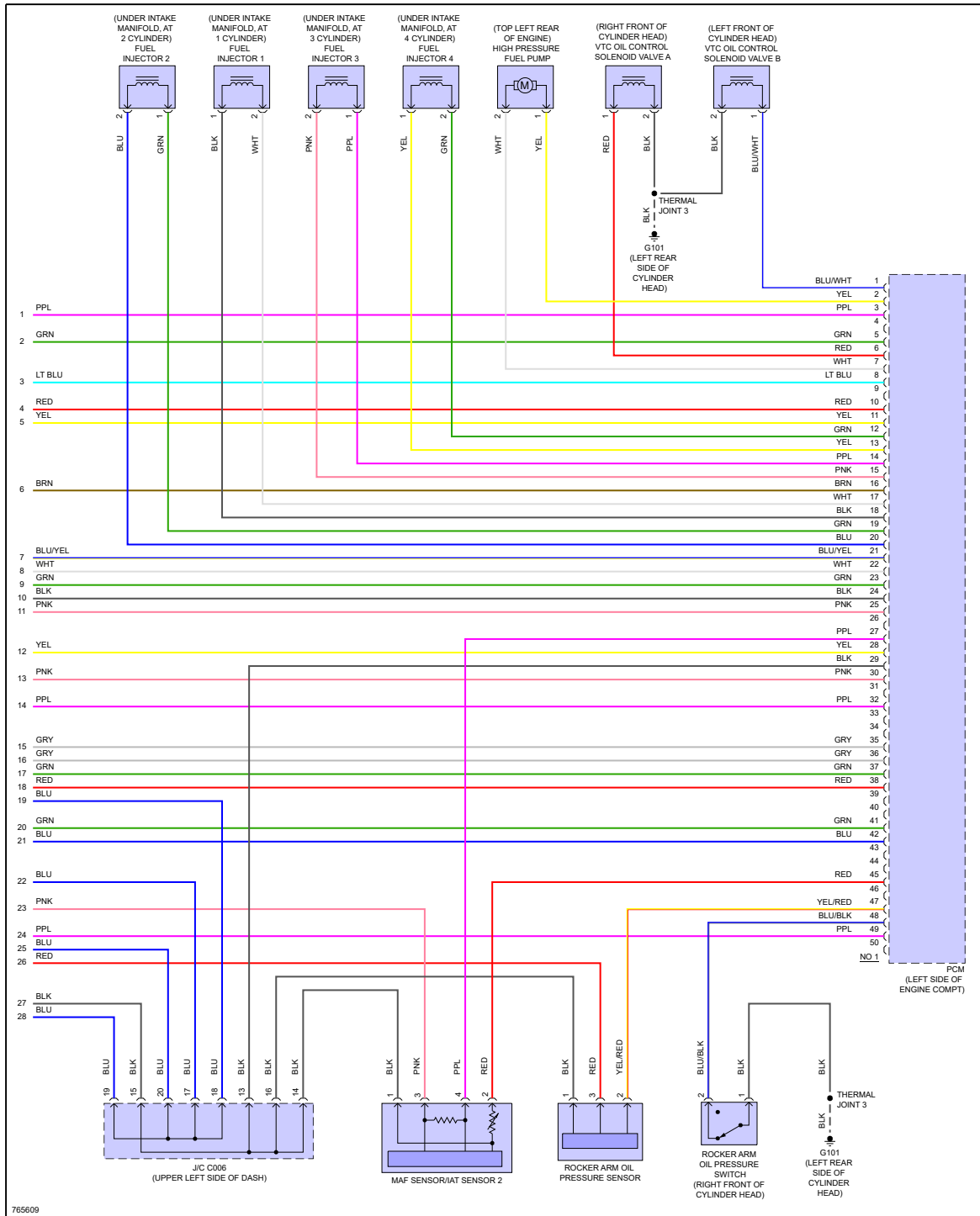

Fig 7: 2.0L Turbo, Engine Performance Circuit (7 of 7)





*"If your car is beat down, bring it to P-Town!"*