

Canbus Control Module (CCM) Installation Walkthrough

V17.1.1

Installed on LHD 2019 Kia Stinger GT2

Write-up and photos courtesy of
©PatriotOne on kiastinger.org & stingerforum.org

patriotone11@gmail.com

CCM Harness

Note the indicated Harness #'s will be referenced throughout this document.

- The LHD wiring map can be accessed from [here](#).
- CCM feature list can be accessed from [here](#).
- Harness #1 is the sunroof connection and is optional, i.e., if you don't plan to use the sunroof features, installing this harness is not required.

CCM Device v17.1.1

Green	ISO	Harness #2 (Power)	DIP SWITCH	<input type="checkbox"/>	<input type="checkbox"/>	Harness #1 (Sunroof)
Orange	AUX #1 GND			OFF	<input type="checkbox"/>	
Black	GND			OFF	<input type="checkbox"/>	
Red	+12V			OFF	<input type="checkbox"/>	
Yellow	BlueLink & UVO			OFF	<input type="checkbox"/>	
White	RPM				ON	
Brown	Shock Sensor				ON	
			OFF	<input type="checkbox"/>		
Blue	B-CAN [High]	Harness #3 (Comms)			SUNROOF	
Red	B-CAN [Low]					
White	START	Harness #4 (Systems)	<input checked="" type="checkbox"/>	Brown		
Green	IG2 : Terminal Control		<input checked="" type="checkbox"/>	Purple		
Yellow	IG1 : Terminal Control		<input checked="" type="checkbox"/>	Orange		
Sky	AUX #2 +12V		<input checked="" type="checkbox"/>	Blue		
Purple	AUX #3 GND		<input checked="" type="checkbox"/>	Gray		
Orange	SSB #1		<input checked="" type="checkbox"/>			
Blue	SSB #2		<input checked="" type="checkbox"/>			
Red	AUX #4 +12V		<input checked="" type="checkbox"/>			
Brown	Door Outside Switch		<input checked="" type="checkbox"/>			
Gray	Piezo Buzzer		<input checked="" type="checkbox"/>			
Pink	Hazard Switch	<input checked="" type="checkbox"/>				

Notes

- Keep this walkthrough handy to reference throughout the install.
- Put on gloves to protect your hands and use a plastic panel removal tool to remove interior trim pieces.
- Take care not to bend or scratch the trim and panels.
- The wiring diagram shows wires connection from bottom of connectors, not the wire side, i.e., the diagram appears reverse when looking from wire side.
- Set DIP switches as indicated, all OFF except switches 6 and 7
 - Confirm hidden DIP #1 is set to OFF
- There are 5 wires from Harness #2 and #4 that are not used; these wires can be cut.
- Practice wire management from the start. Use cable ties, heat shrink and insulating tape to group wires based on route.
- NOTE, this is a permanent installation, posi-taps are not recommended by manufacturer.



Tools and Soldering

Tools Needed:

- Philips screwdriver
- 10mm Hex Nut remover
- Wire stripper
- Heat shrink
- Electrical insulating tape
- Zip ties
- Soldering iron w/solder
- Trim panel removal tool

Soldering:

Since we are connecting to existing system wires, the preference is to tap wires and solder to ensure a solid connection.

1. Start by stripping the system wire
2. Wrap the connecting wire around the exposed wire
3. Solder the wires together; ensure that soldering iron heats the wires and not the solder
4. Finish by applying insulating tape or heat shrink (5)

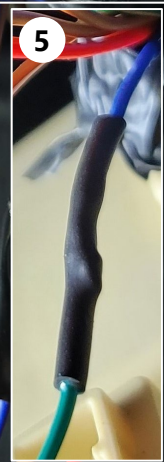
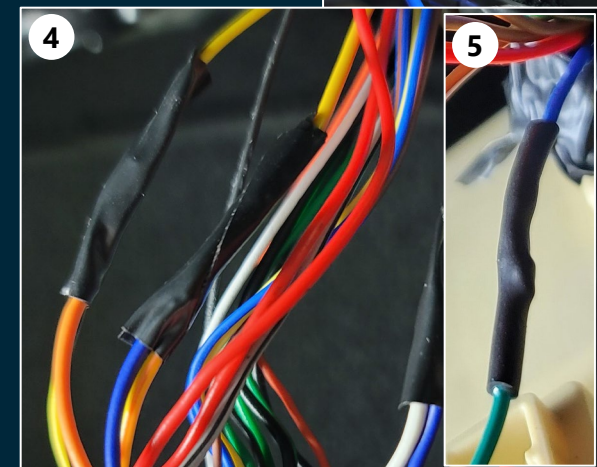
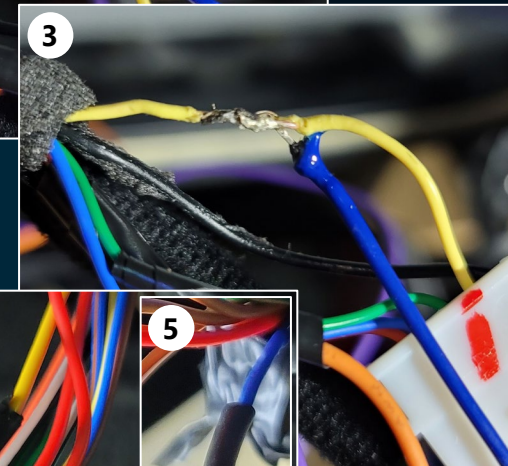
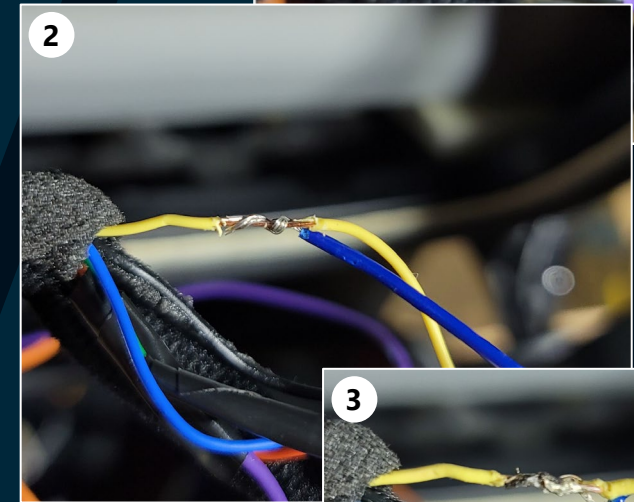
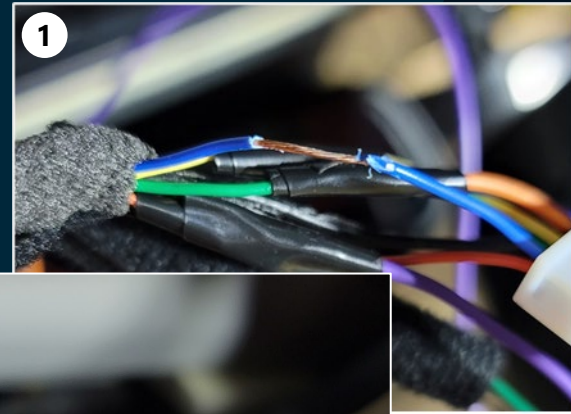



Installation Plan

Estimated install time is based on your level of experience and confidence. This can take anywhere from 3 to 5 hours. Don't rush and plan accordingly, take your time!

The steps below are the most logical install flow:

- Step 1 – Sunroof (5 Wires)
 - NOTE. Skip to Step 2 if Sunroof install not required.
 - 4 x wires inside Overhead Console Lamp
 - 1 x wire inside Cowl Side Trim [LH]
- Step 2 – Internal Fuse Box Connections (8 Wires)
 - Harness #2 to Fuse Box (I/P-D): 1 x Wire
 - Harness #2 Orange Wire to Relay Black: 1 x Wire
 - Relay to Rear Fuse Box (I/P-E & I/P-F): 5 x Wires
 - I/P-E: 2 x Wires – Blue/Green cut Blue (2)
 - I/P-E: 2 x Wires – Orange/Pink cut white stripe on Brown (12)
 - I/P-F: 1 x Wire – Red tap into Blue (19)
 - Harness #4 to Rear Fuse Box (I/P-F): 1 x Wire
- Step 3 – Passenger Footwell Connections (12 Wires)
 - Harness #3 (Green Connector): 2 Wires
 - Harness #3/4 (Blue Connector): 4 Wires
 - Harness #2 (Red Connector): 6 Wires (8 Solder Points)
- Total Connections
 - 25 Wires
 - 30 Solder Points

Step 1 – Sunroof (5 Wires)

Wires:

- 4 x wires inside Overhead Console Lamp
- 1 x wire inside Cowl Side Trim [LH]

Tasks:

- Remove Overhead Console Lamp
- Strip/Tap 4 sunroof Harness #1 wires (2, 3, 4, 5)
- Remove Front Pillar Trim [LH]
- Remove Crash Pad Side Panel [LH]
- Remove Front Door Scuff Trim [LH]
- Remove Cowl Side Trim [LH]
- Strip/Tap 1 wire (MF11)

NOTE. Skip to Step 2 if Sunroof install is not required.

Harness #1

S	•	Brown
U	•	Purple
N	•	Orange
R	•	Blue
O	•	Gray
O		
F		

XTRA	OFF	1
DIP	OFF	2
	OFF	3
	OFF	4

•	Pink
•	Gray
•	Green
•	Yellow

Sunroof switch connector inside the roof

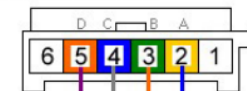

- (2) Yellow
- (3) Green
- (4) Blue
- (5) Orange

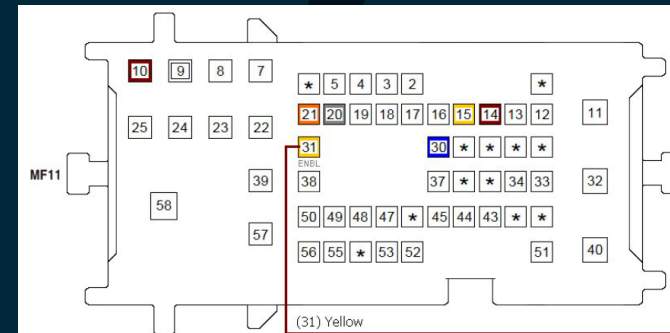

1A. Remove Overhead Console Lamp

1. Disconnect the negative (-) battery terminal.
2. Remove the overhead console lamp (A) by removing the 2 x mounting screws.
3. Then pull down on the sunglasses holder to release the console.
4. Remove connector (B) and pull back insulation cover to expose wires (C).

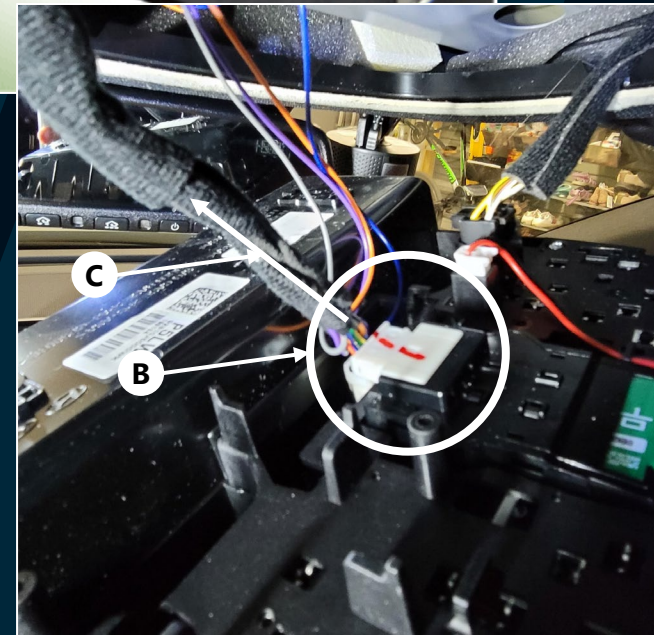

1B. Strip/Tap 4 sunroof wires

It's time to strip and solder the first 4 sunroof wires.

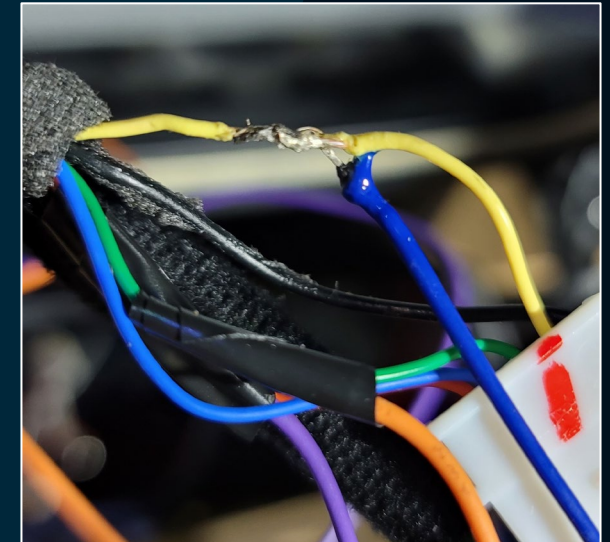
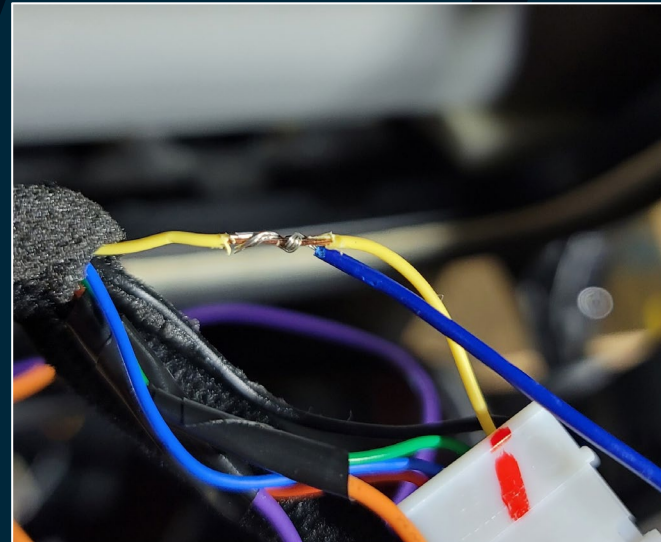
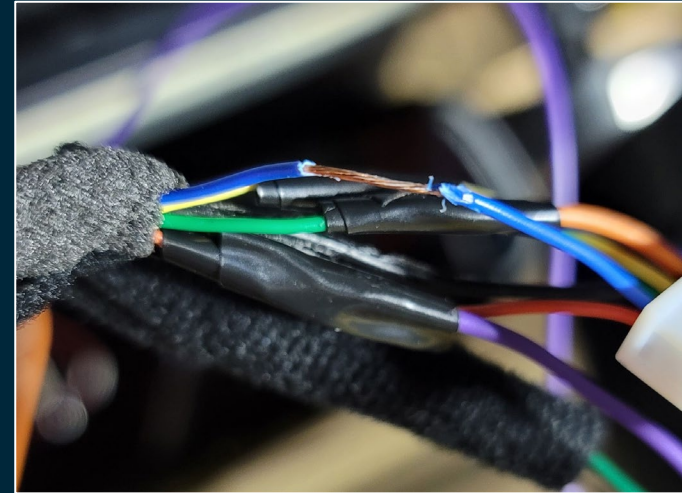
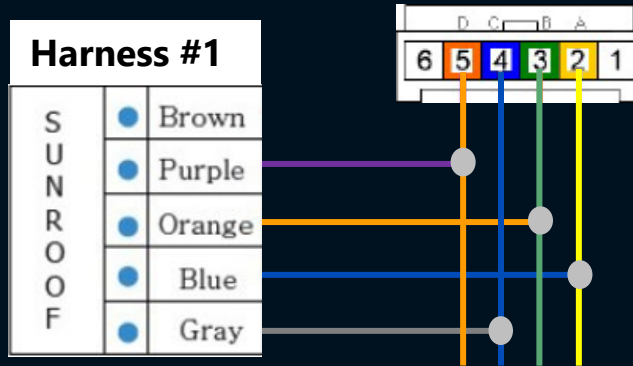

1C. Remove Front Pillar Trim [LH]

- It's easier not to completely remove this panel; you just need enough space to pass the sunroof harness wires.
1. Separate the pillar trim and then remove the front pillar trim (A) by pushing the mounting clip in the direction of the arrow.
 2. Starting from the top down, fish the sunroof wires through to the top of the Front Pillar Trim previously removed.

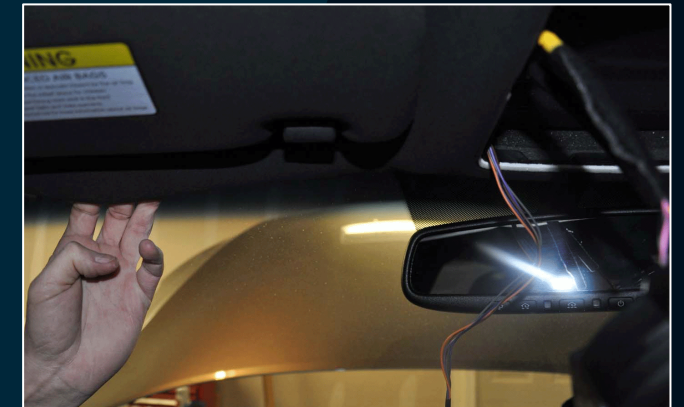
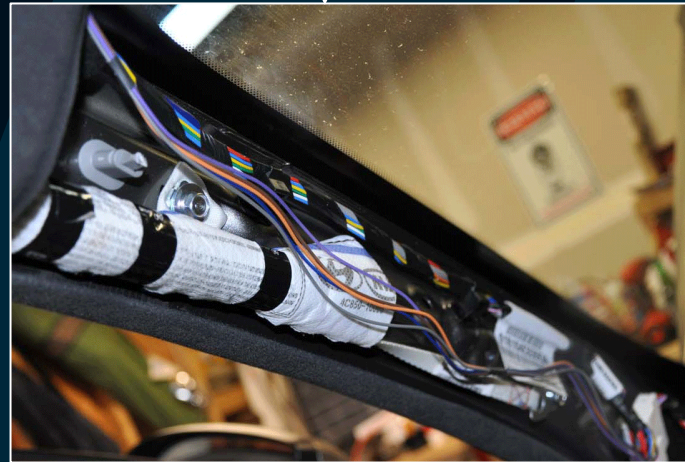
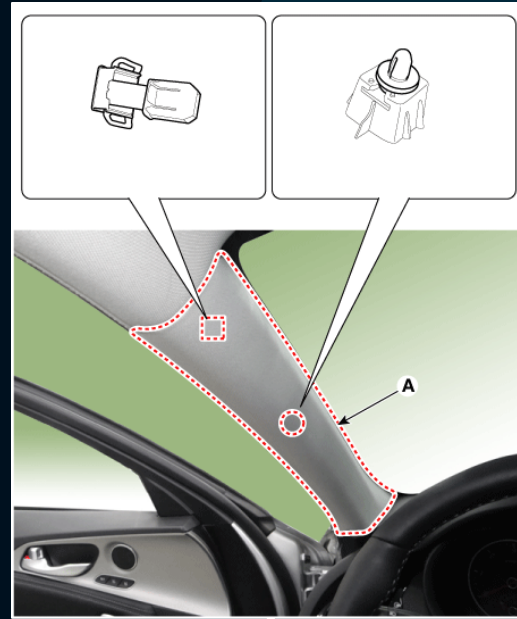

1D./E./F. Remove Crash Pad Side Panel, Front Door Scuff & Cowl Side Trim [LH]

1. Carefully remove the front door body side weather strip.
2. Remove Crash Pad Side Panel (A) using a remover.
3. Remove the front door scuff trim (B) using a remover.
4. Remove the hood latch release handle (C) using a remover.
5. Remove the cowl side trim (D) using a remover.

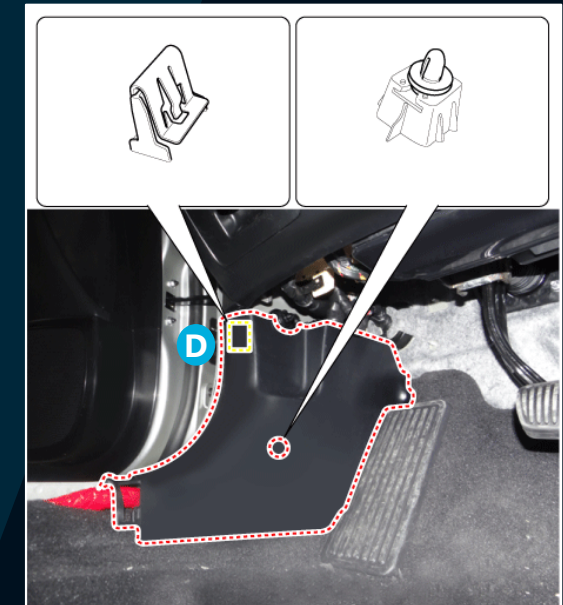
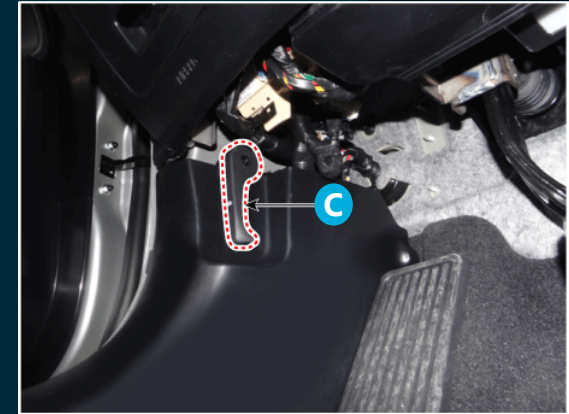
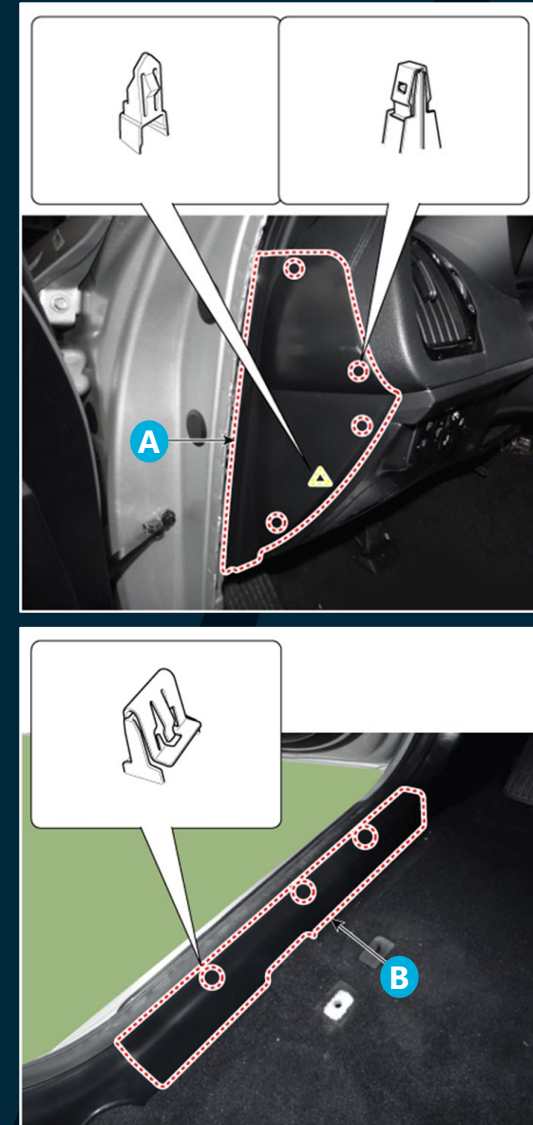

1G. Strip/Tap 1 Wire (MF11)

- Remove the insulating tape and pop out the plastic cover to get to wires.
- Tap the brown sunroof harness wire to the Yellow (31) MF11 connector wire.



Harness #1	
S U N R O O F	● Brown
	● Purple
	● Orange
	● Blue
	● Gray

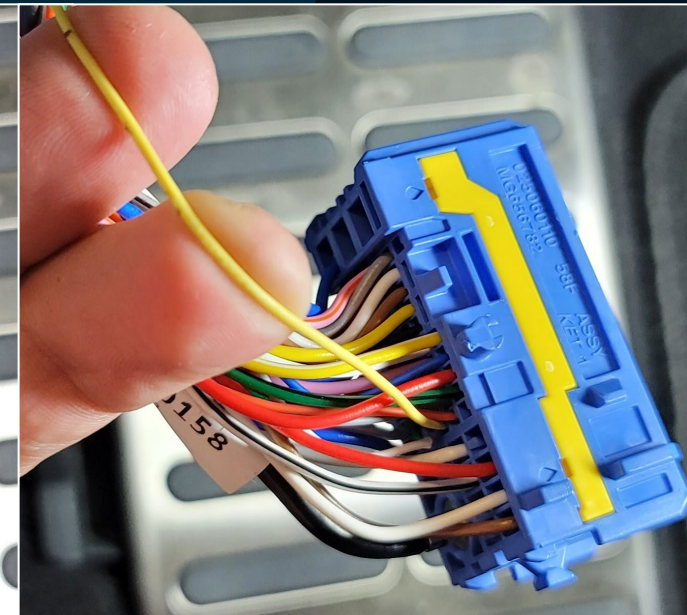
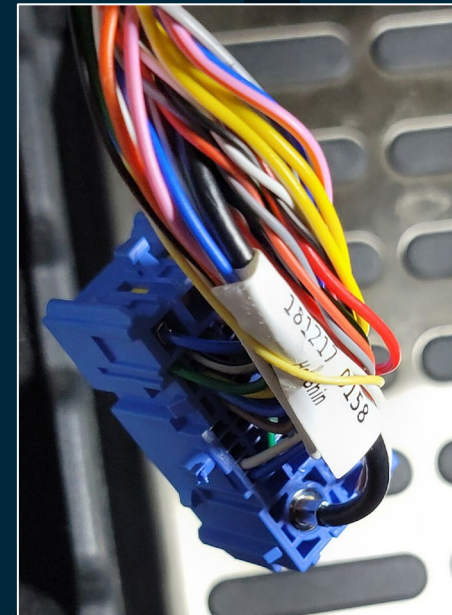
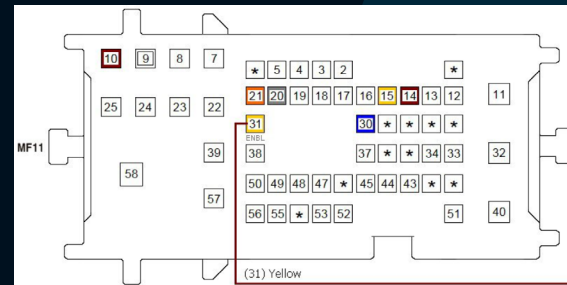

Step 2 – Internal Fuse Box Connections (8 Wires)

Wires:

- Harness #2 to Fuse Box (I/P-D): 1 x Wire
- Harness #2 Orange Wire to Relay Black: 1 x Wire
- Relay to Rear Fuse Box (I/P-E & I/P-F):
 - I/P-E: 2 x Wires – Blue/Green cut Blue (2)
 - I/P-E: 2 x Wires – Orange/Pink cut white stripe on Brown (12)
 - I/P-F: 1 x Wire – Red tap into Blue (19)
- Harness #4 to Rear Fuse Box (I/P-F): 1 x Wire

Tasks:

- Remove Crash Pad Lower Panel and Fuse Box Mounting Bolts
- Strip/Tap 1 Wire to Fuse Box (I/P-D) from Harness #2
- Strip/Tap 5 Wires to I/P-E and Harness #2 From Relay
- Strip/Tap 2 Wires to Relay and Harness #4 from I/P-F

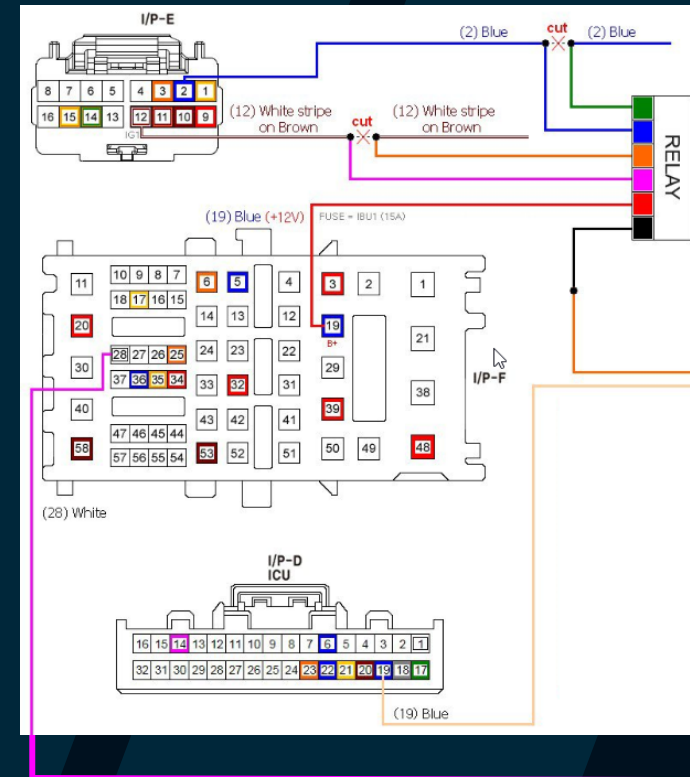

Harness #2

Green	ISO
Orange	AUX #1 GND
Black	GND
Red	+12V
Yellow	BlueLink & UVO
White	RPM
Brown	Shock Sensor

Harness #4

White	START
Green	IG2 : Terminal Control
Yellow	IG1 : Terminal Control
Sky	AUX #2 +12V
Purple	AUX #3 GND
Orange	SSB #1
Blue	SSB #2
Red	AUX #4 +12V
Brown	Door Outside Switch
Gray	Piezo Buzzer
Pink	Hazard Switch

2A. Remove Crash Pad Lower Panel and Fuse Box Mounting Bolts

- Remove the 3 screws securing Crash Pad Lower Panel (A)
- Using remover tool, gently remove the Crash Pad (B)
- Remove 2 screws securing the OBD connector (C) to Crash Pad
- Using bendy hex tool, remove the two upper bolts (D) securing the fuse box
- Pull fuse box forward to access rear Fuse Box connectors I/P-E & I/P-F

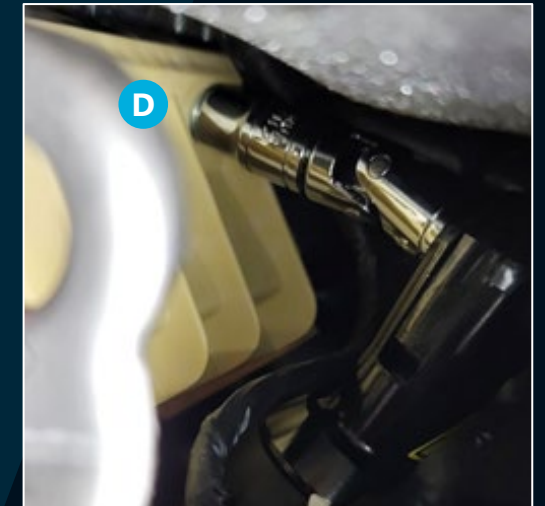
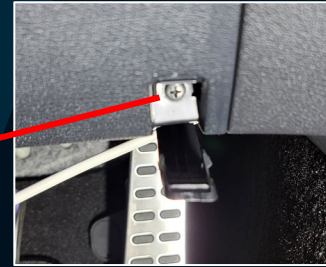
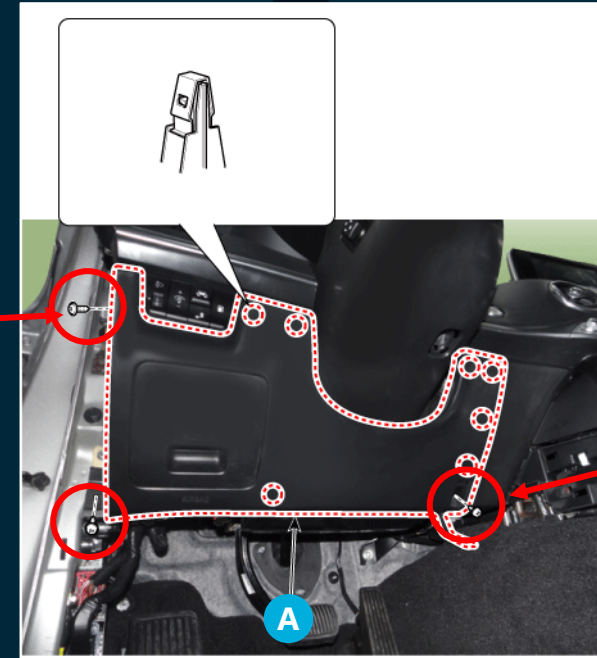
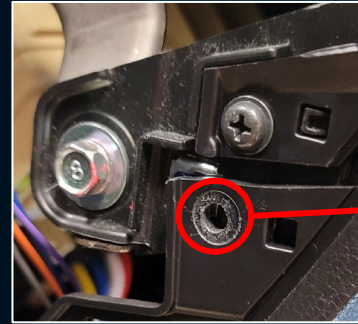

2B. Strip/Tap 1 Wire to Fuse Box (I/P-D) from Harness #2

Tap Yellow (BlueLink & UVO) wire from Harness #2 to the Blue (19) I/P-D connector wire

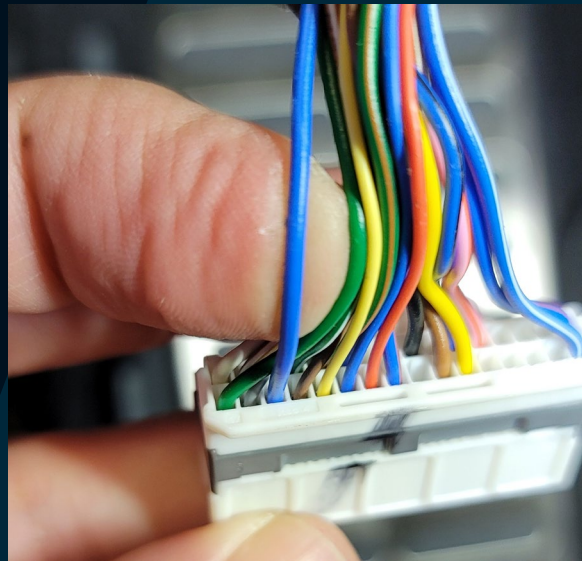
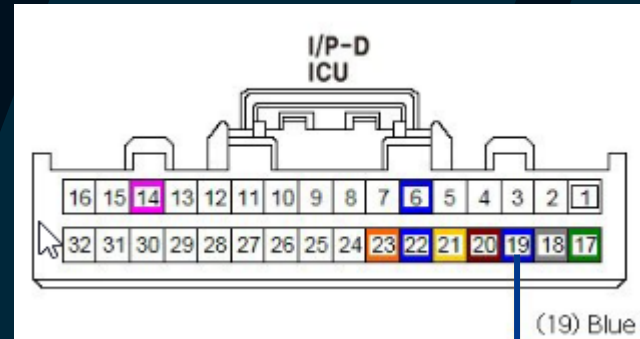

Harness #2	
Green	ISO
Orange	● AUX #1 GND
Black	GND
Red	+12V
Yellow	● BlueLink & UVO
White	RPM
Brown	Shock Sensor

2C. Strip/Tap 5 Wires to Relay and I/P-E

These are the only 2 cuts that need to be made to connect the relay to I/P-E Blue (2) and White Stripe on Brown (12) wires.

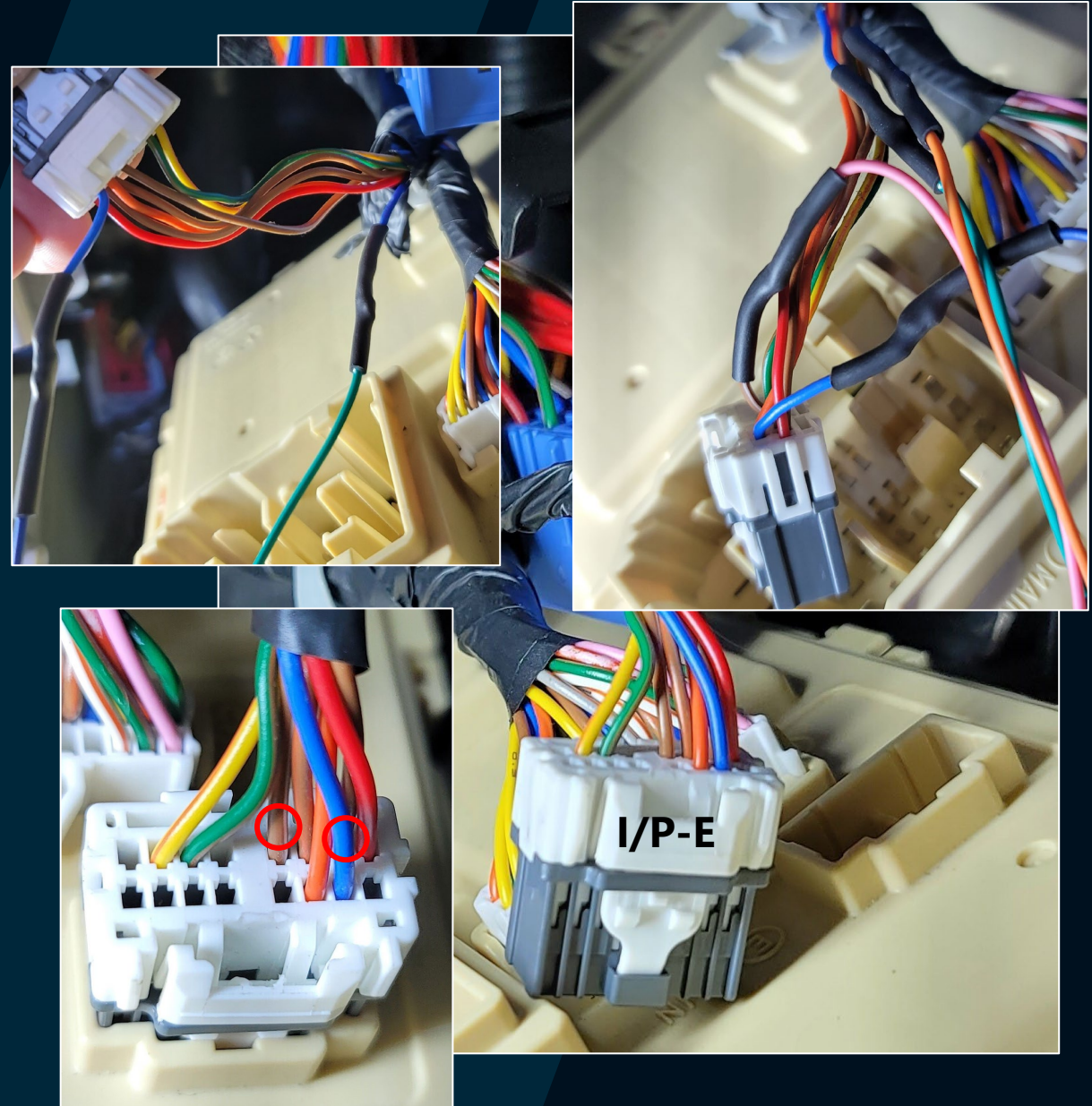
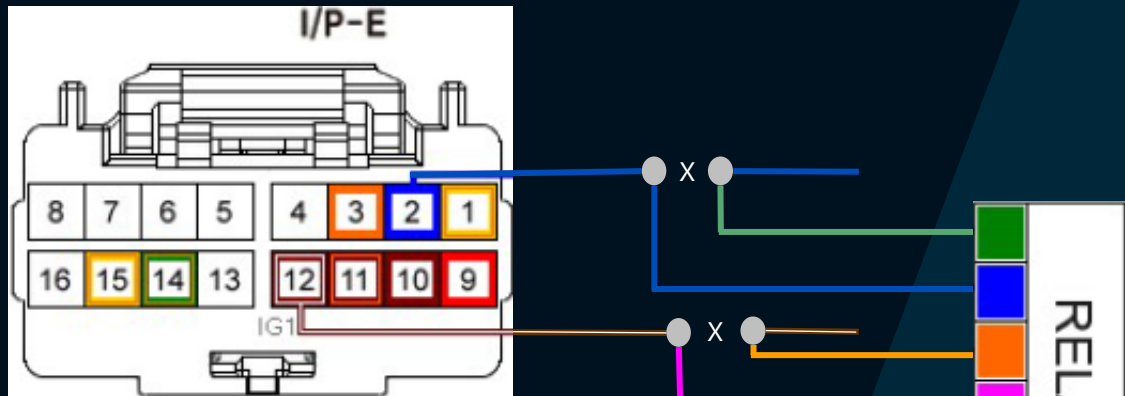

Harness #2	Green	ISO
	Orange	AUX #1 GND
	Black	GND
	Red	+12V
	Yellow	BlueLink & UVO
	White	RPM
	Brown	Shock Sensor

Connect Harness #2 Orange wire to Relay Black wire

2D. Strip/Tap 2 Wires to Relay and Harness #4 from I/P-F

Strip/Tap into I/P-F Blue (19) from Relay Red and White (28) from Harness #4 Pink (Hazard Switch)

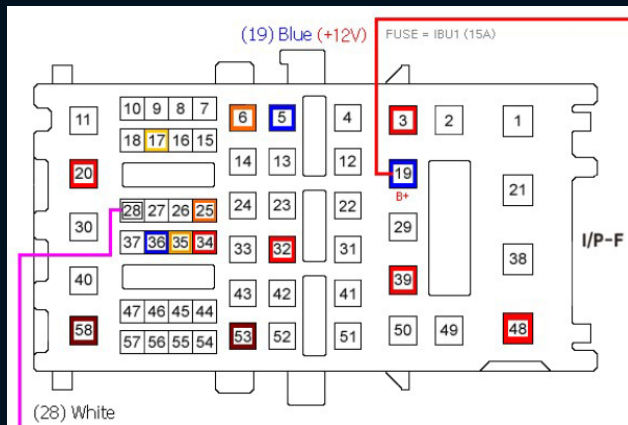
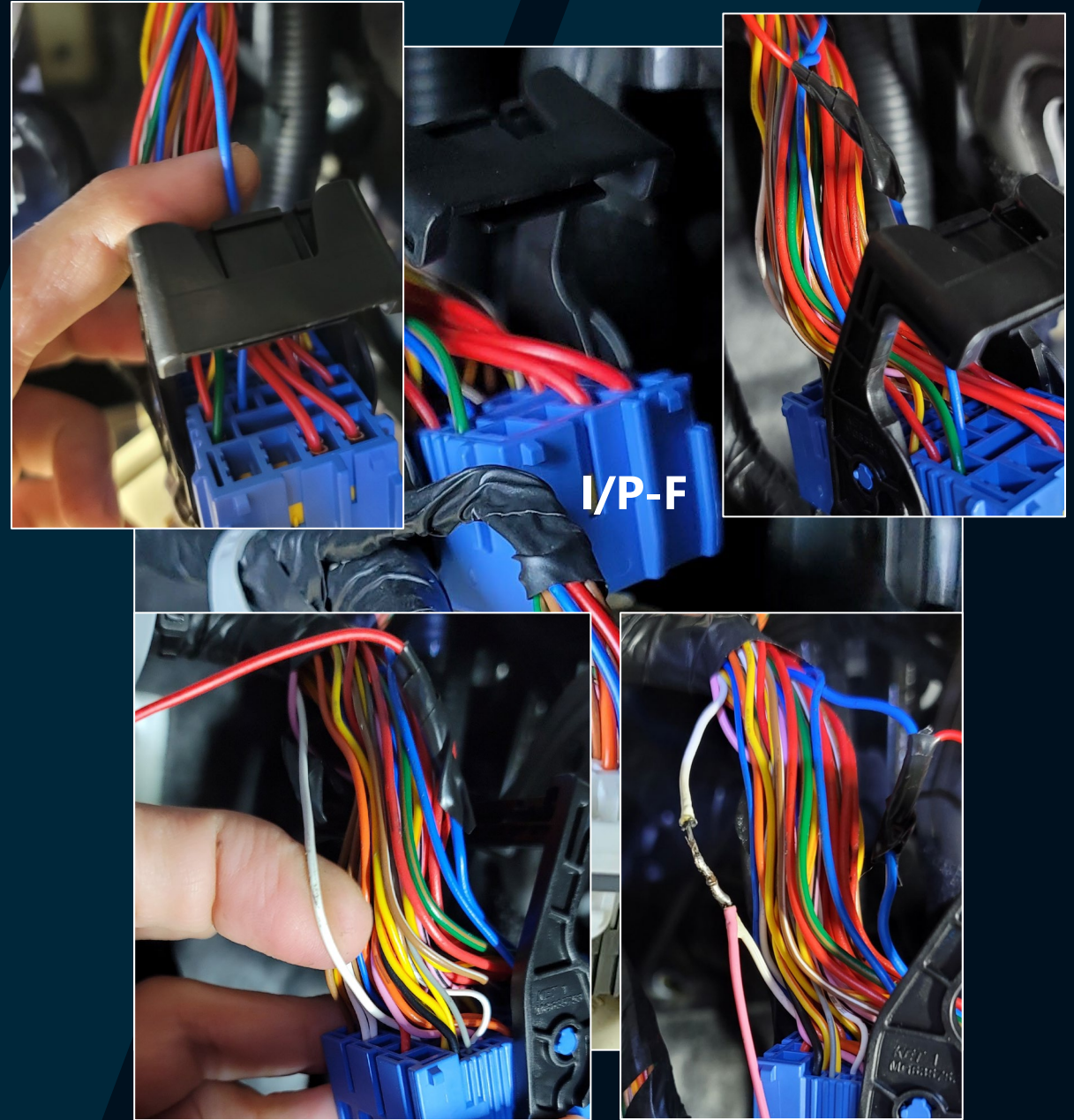

19

28

Harness #4	
White	START
Green	IG2 : Terminal Control
Yellow	IG1 : Terminal Control
Sky	AUX #2 +12V
Purple	AUX #3 GND
Orange	SSB #1
Blue	SSB #2
Red	AUX #4 +12V
Brown	Door Outside Switch
Gray	Piezo Buzzer
Pink	Hazard Switch

Canbus Controller Location

With the driver side taps complete, it's a good idea to think about where to store the CCM.

Select an accessible location in the central console for reprogramming or making DIP switch adjustments.

In the photo the CCM is stored on the driver side of the center console, just behind the Lower Crash Pad. Secured with a long zip tie.

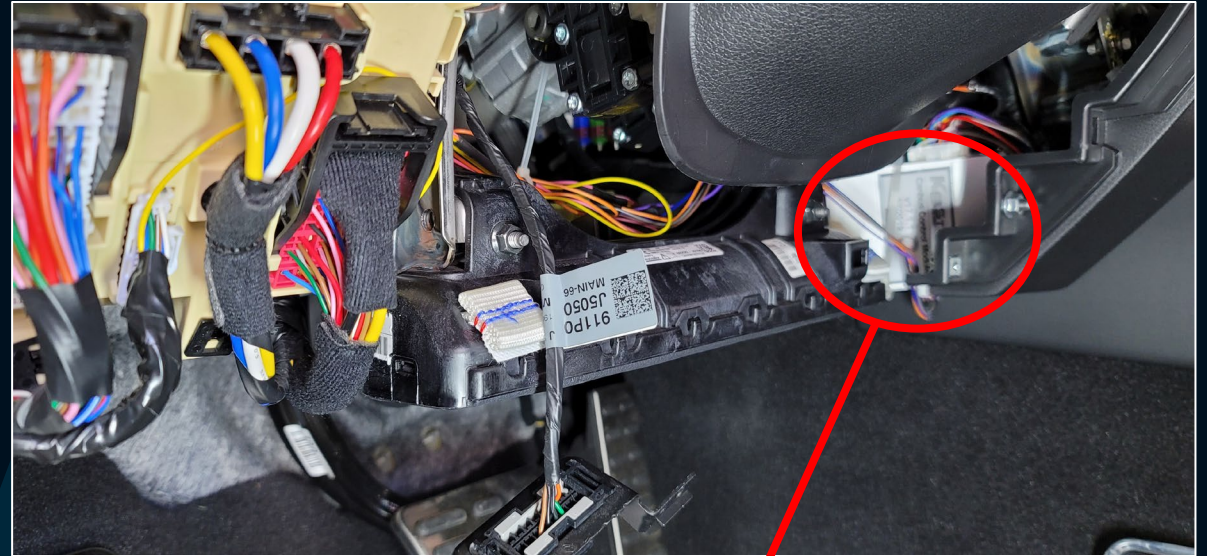

Step 3 – Passenger Footwell Connections (12 Wires)

- A. Remove Crash Pad Under Cover
- B. Strip/Tap M01-A (Green): 2 Wires from Harness #4
- C. Strip/Tap M01-B (Blue): 4 Wires from Harness #3 & #4
- D. Strip/Tap M01-C (Red): 6 Wires From Harness #2 & #4
 - Connect Diode to M01-C and Harness #4

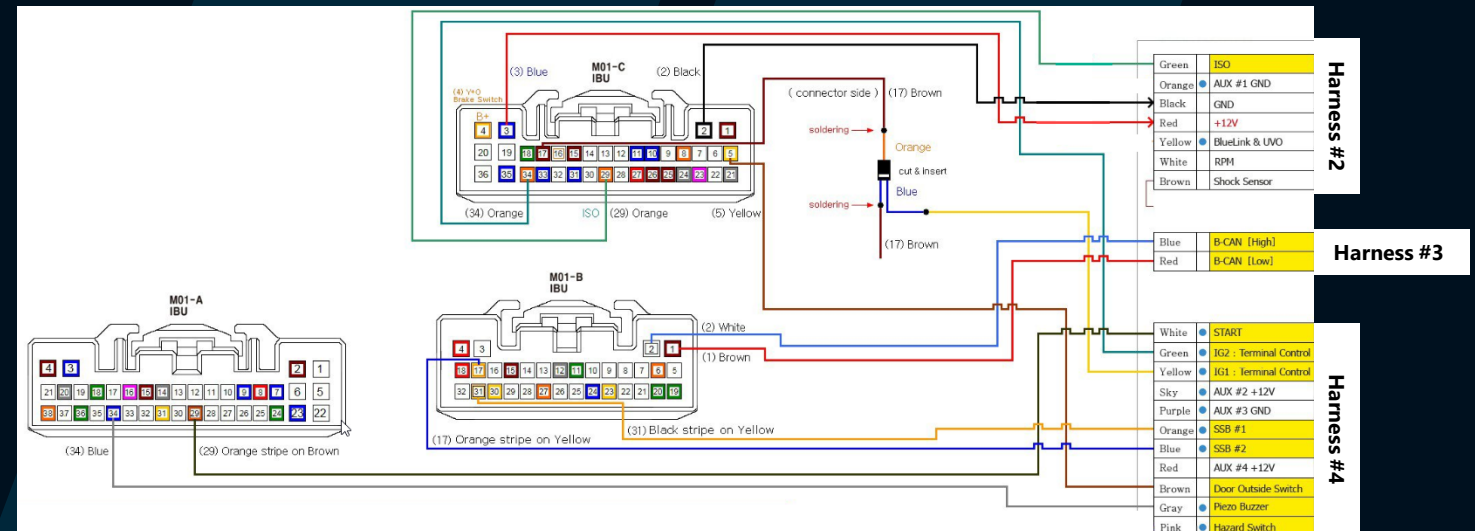

3A. Remove Crash Pad Under Cover

- Using a trim panel removal tool, separate crash pad under cover panel by applying pressure at locations marked with the blue circle (A).

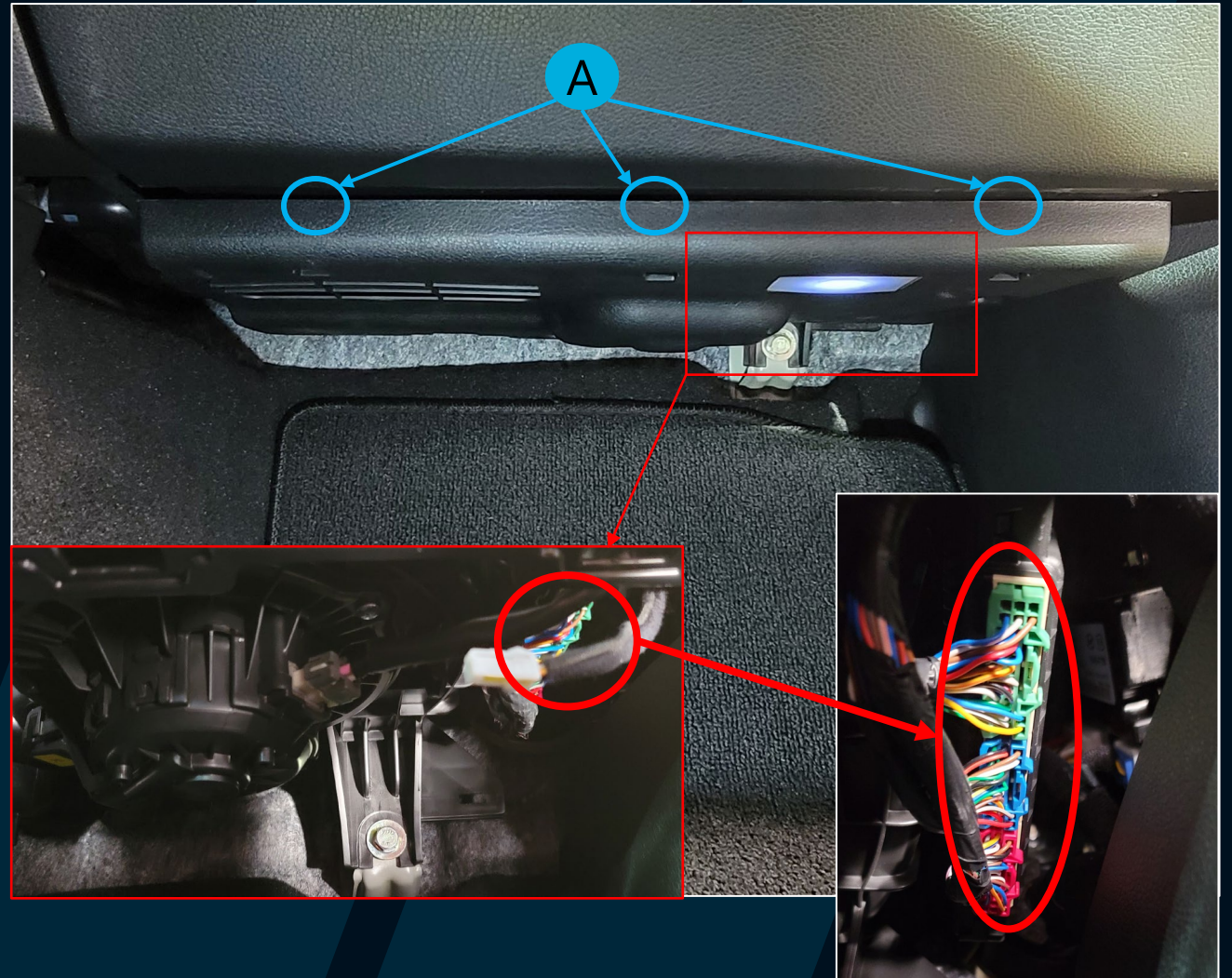
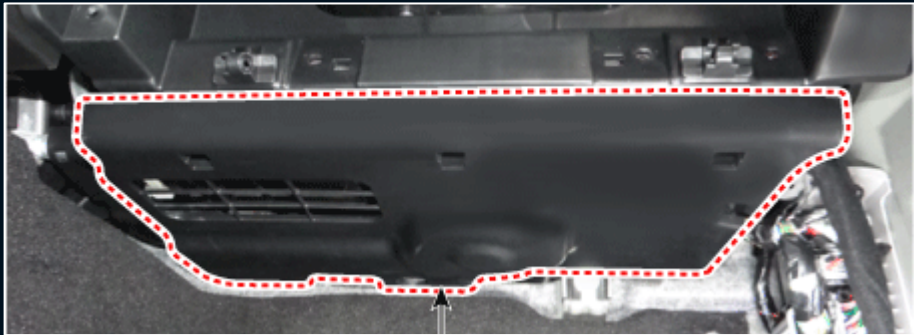

3B. Strip/Tap M01-A (Green): 2 Wires from Harness #4

- Unplug Harness A (Green) and remove the insulation tape to expose the wires.
- Identify the 2 wires that need to be tapped

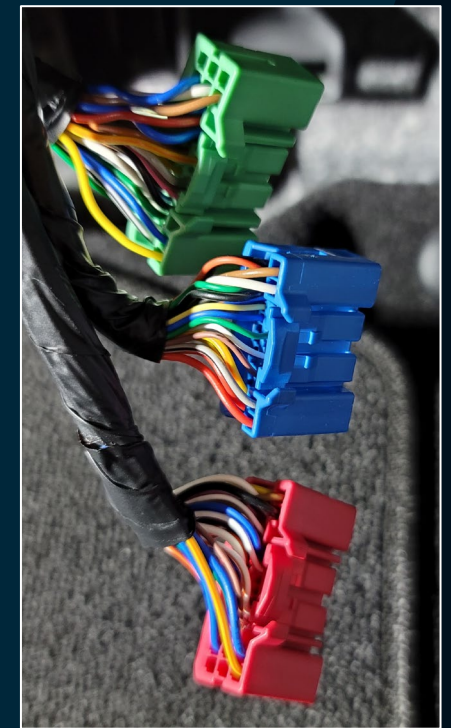
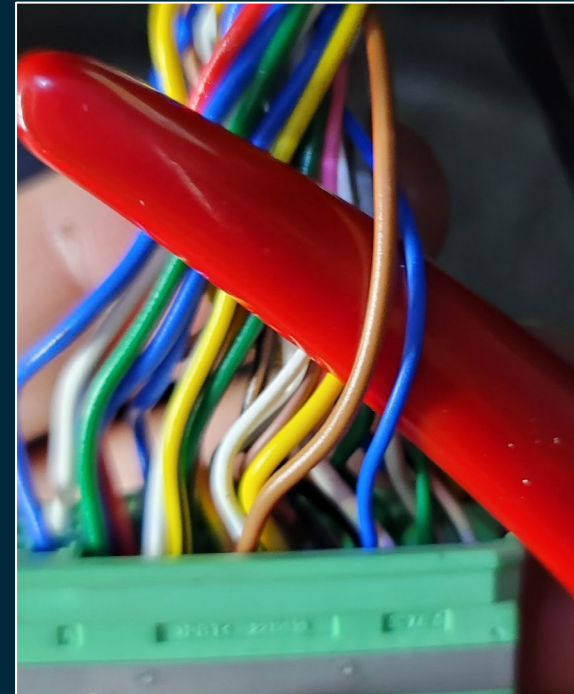
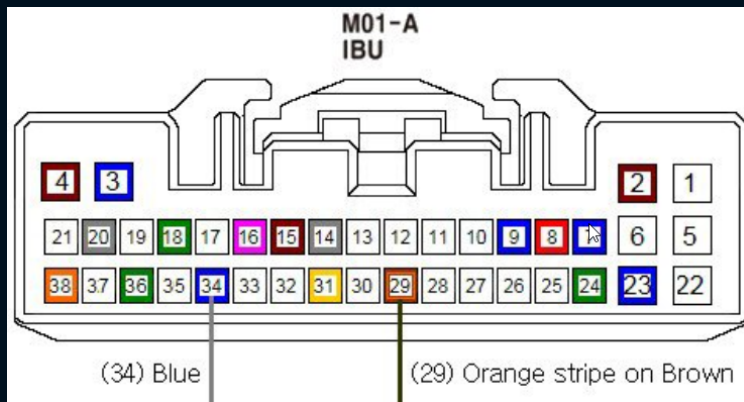

Harness #4	
White	START
Green	IG2 : Terminal Control
Yellow	IG1 : Terminal Control
Sky	AUX #2 +12V
Purple	AUX #3 GND
Orange	SSB #1
Blue	SSB #2
Red	AUX #4 +12V
Brown	Door Outside Switch
Gray	Piezo Buzzer
Pink	Hazard Switch



3C. Strip/Tap M01-B (Blue): 4 Wires from Harness #3 & #4

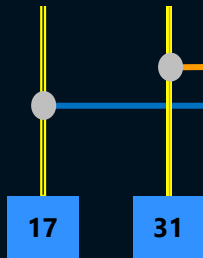
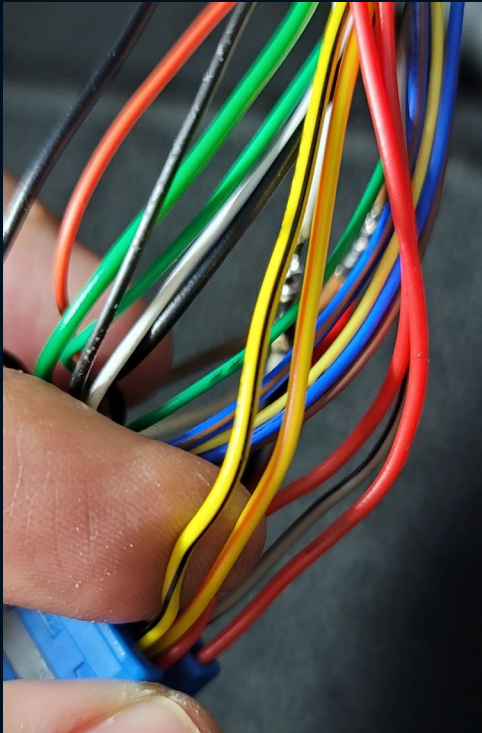

Harness #4	
White	START
Green	IG2 : Terminal Control
Yellow	IG1 : Terminal Control
Sky	AUX #2 +12V
Purple	AUX #3 GND
Orange	SSB #1
Blue	SSB #2
Red	AUX #4 +12V
Brown	Door Outside Switch
Gray	Piezo Buzzer
Pink	Hazard Switch

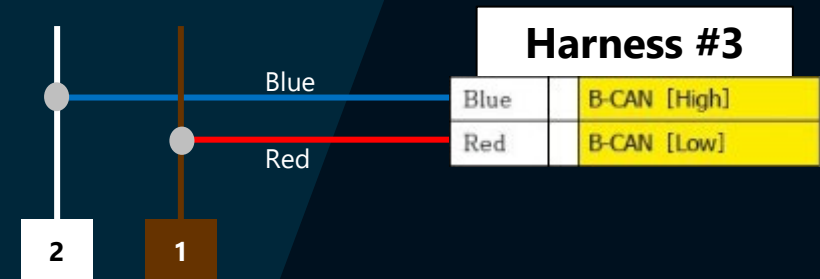
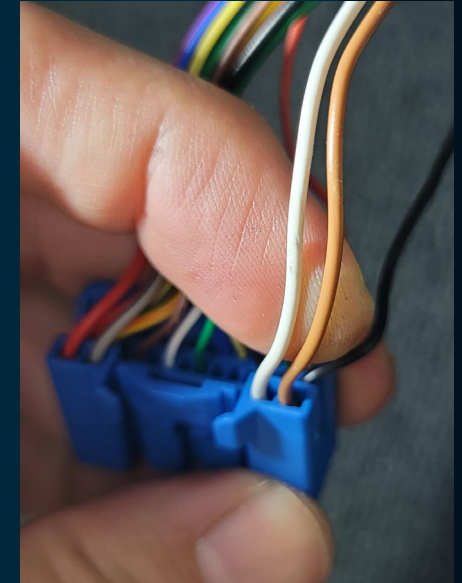
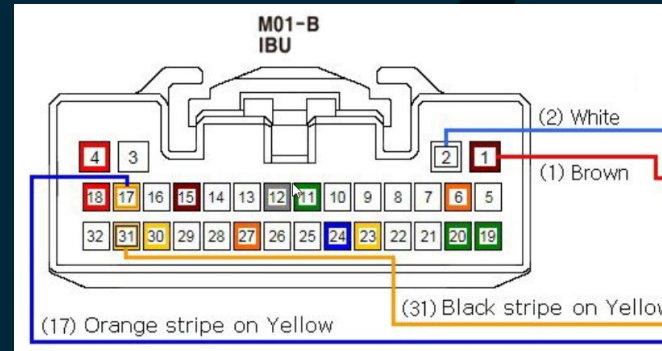

3D. Strip/Tap M01-C (Red): 6 Wires From Harness #2 & #4

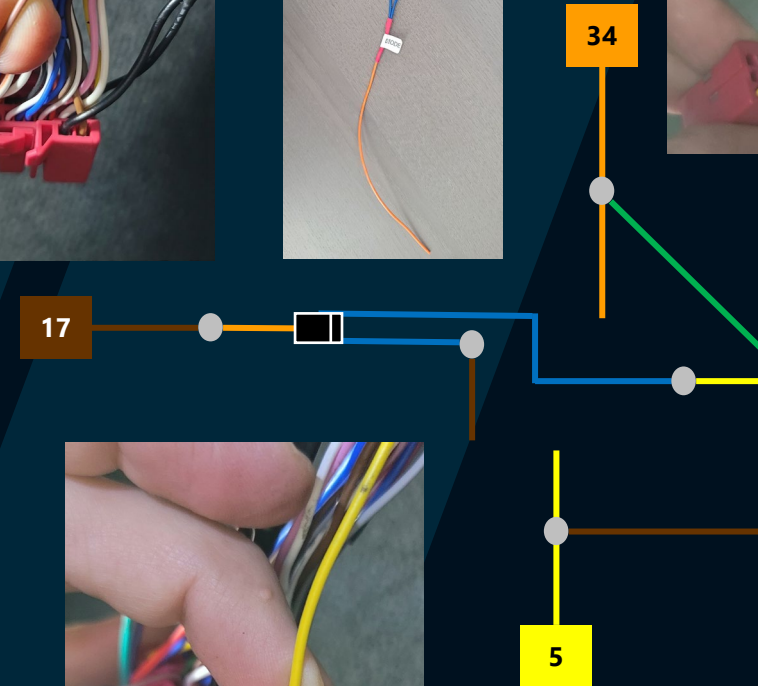
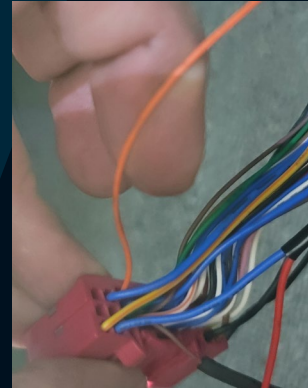
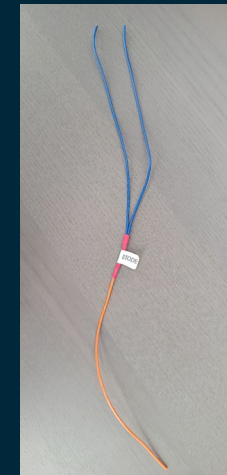
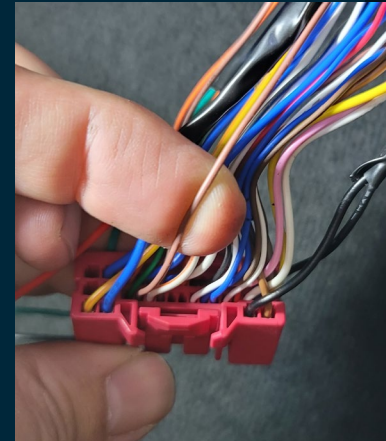
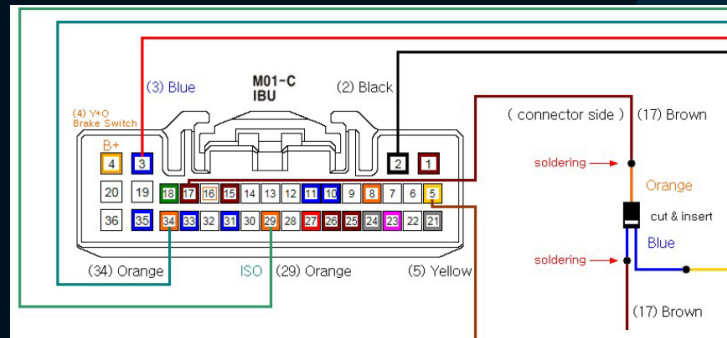
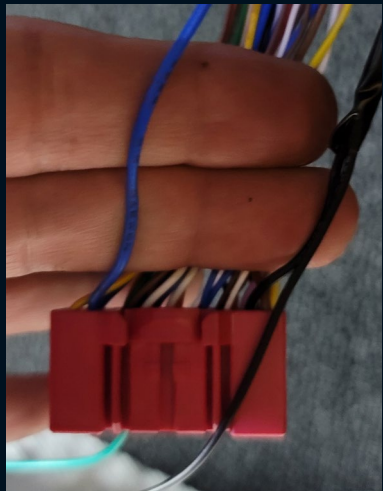

Harness #2	
Green	ISO
Orange	AUX #1 GND
Black	GND
Red	+12V
Yellow	BlueLink & UVO
White	RPM
Brown	Shock Sensor



Harness #4	
White	START
Green	IG2 : Terminal Control
Yellow	IG1 : Terminal Control
Sky	AUX #2 +12V
Purple	AUX #3 GND
Orange	SSB #1
Blue	SSB #2
Red	AUX #4 +12V
Brown	Door Outside Switch
Gray	Piezo Buzzer
Pink	Hazard Switch

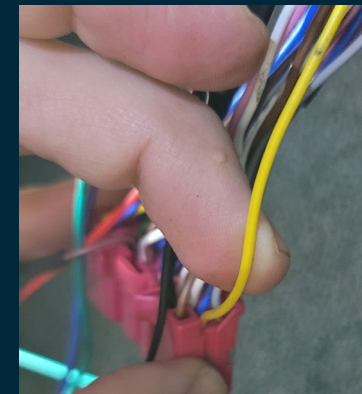
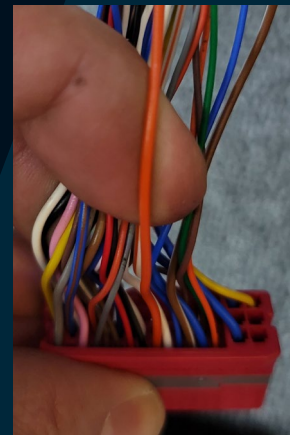

Reconnect the Battery and Connect the Harnesses

- The CCM will beep one-time and then two times. That's it, enjoy!
- Refer to the [Programming Guide](#) to enable or disable stock features and for some interesting feature modifications. A few useful modifications are:
 1. To deactivate or activate the CCM, enter programming code 0119 (deactivation will switch all CCM functions OFF)
 2. To disable or enable the automatic proximity lock temporarily:
 - Turn the power off and only keep the driver's door open.
 - Push the driver door smart button briefly three times.
 - If set to disable, the module locks & unlocks the door once.
 - If set to enable, the module locks & unlocks the door twice.
 - Once the driver turns the power on or starts the engine, the CCM will revert to automatic proximity lock again.
 3. Gasoline models can enable "Quick Remote Start"; enter programming code 0130 to enable/disable.
 4. To reset the CCM to factory defaults use the programming code 0911.