

HARNESS-CHASSIS, RZR PRO R 4 (ULTIMATE)

WIRE COLOR LEGEND	
BG	BEIGE (TAN)
BLK	BLACK
BLU	LIGHT BLUE
DB	DARK BLUE
BN	BROWN
GY	GRAY
GN	LIGHT GREEN
OG	DARK GREEN
OR	ORANGE
PK	PINK
RD	RED
VT	VIOLET (PURPLE)
WH	WHITE
YE	YELLOW
CL	CLEAR

TWO WIRE COLORS ARE SHOWN WITH MAIN TRACE COLORS. EXAMPLE: RD/YE = RED WITH YELLOW TRACE.

ENGINE GROUND
CHASSIS GROUND
NC = SWITCH NORMALLY CLOSED
NO = SWITCH NORMALLY OPEN
HARNESS: 2416573-01

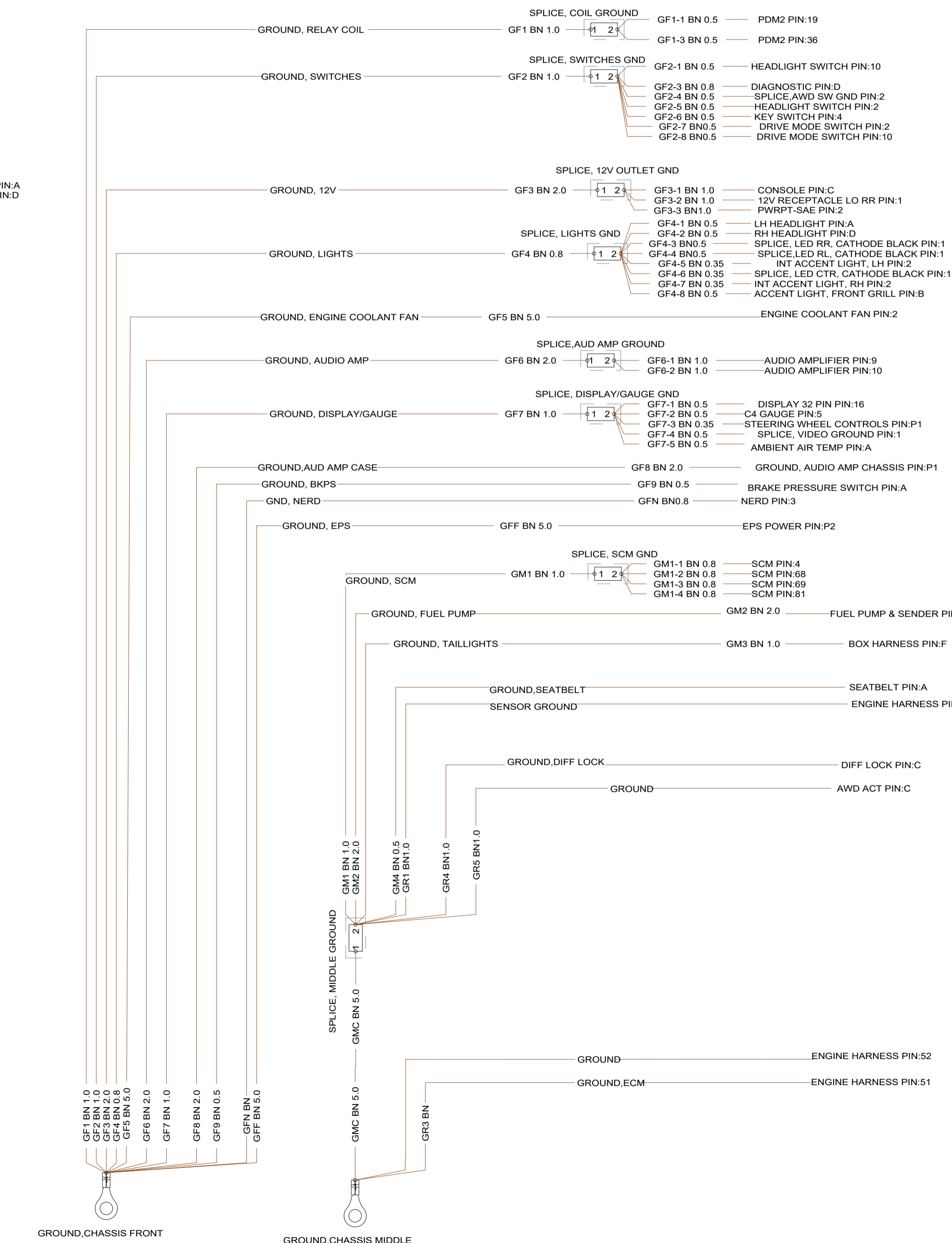
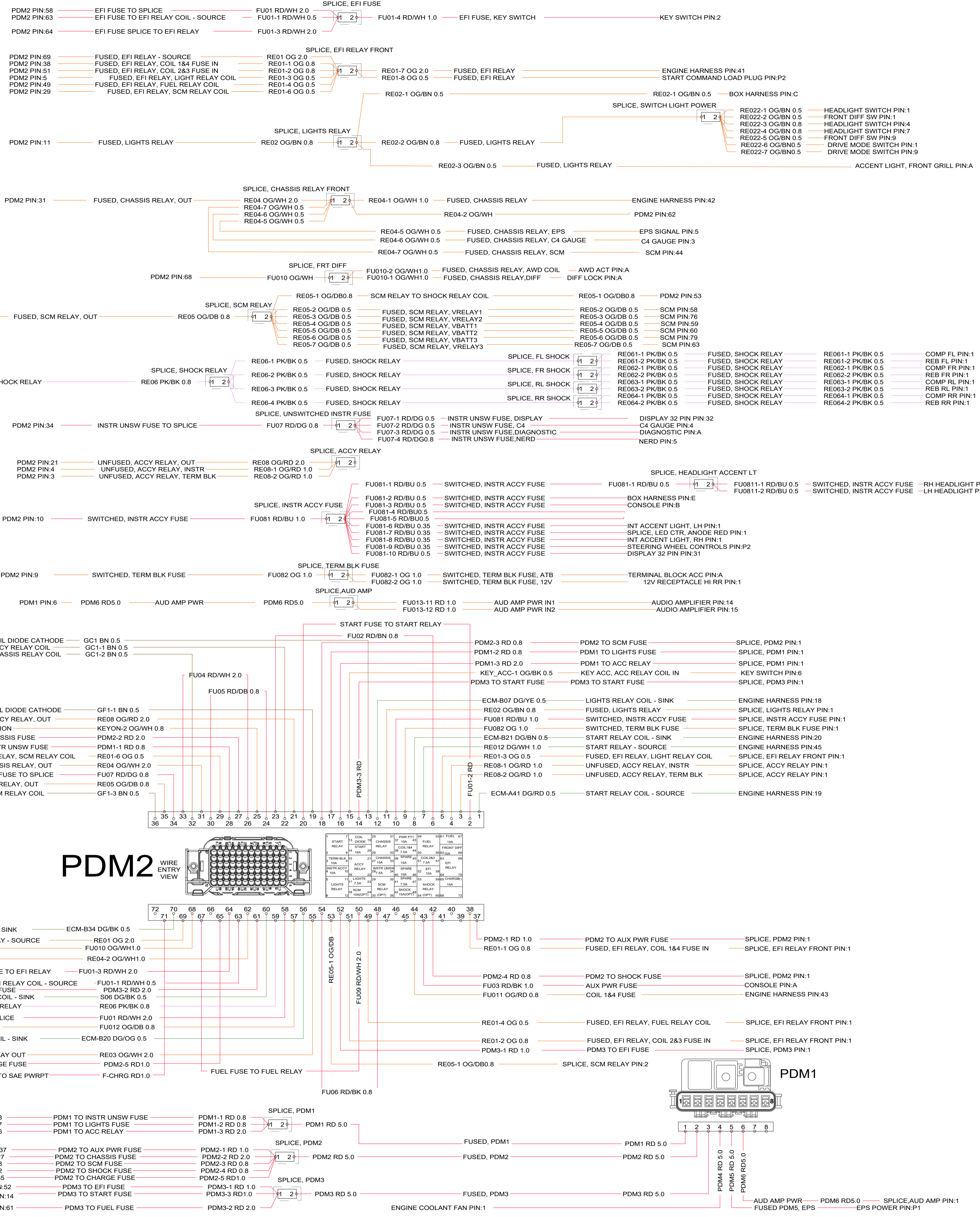

HARNESS-CHASSIS, RZR PRO R 4 (ULTIMATE)

WIRE COLOR LEGEND	
BG	BEIGE (TAN)
BK	BLACK
BU	LIGHT BLUE
DB	DARK BLUE
BN	BROWN
GY	GRAY
GN	LIGHT GREEN
DG	DARK GREEN
OG	ORANGE
PK	PINK
RD	RED
VT	VIOLET (PURPLE)
WH	WHITE
YE	YELLOW
CL	CLEAR

TWO WIRE COLORS ARE SHOWN WITH MAIN TRACE COLORS. EXAMPLE: RD/YE = RED WITH YELLOW TRACE.

ENGINE GROUND
 CHASSIS GROUND
 NC = SWITCH NORMALLY CLOSED
 NO = SWITCH NORMALLY OPEN
 HARNESS: 2416573-01

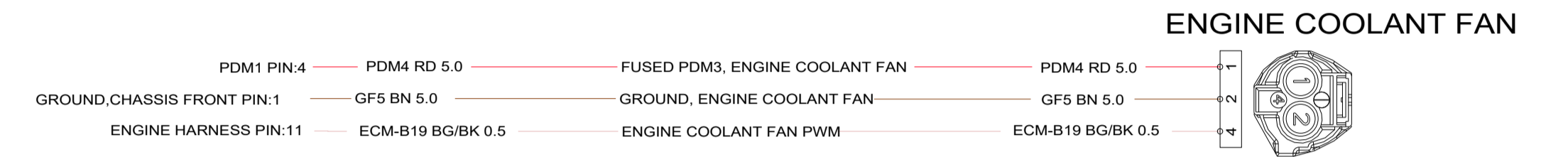
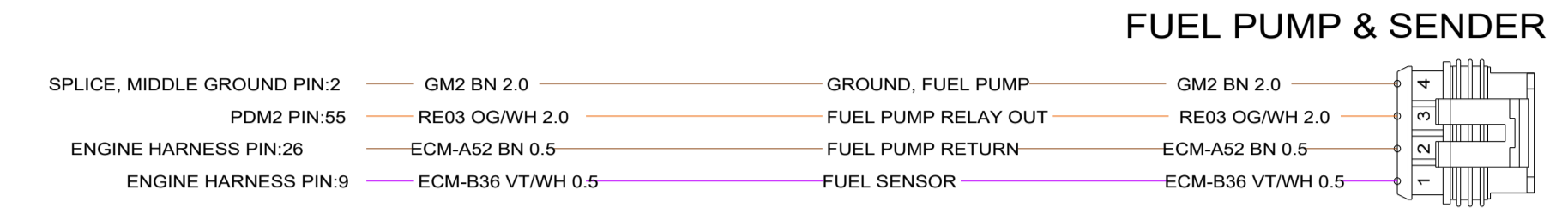
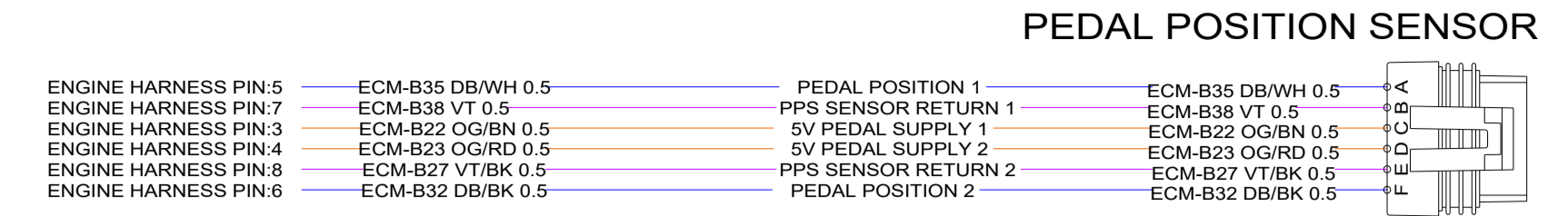

ENGINE HARNESS

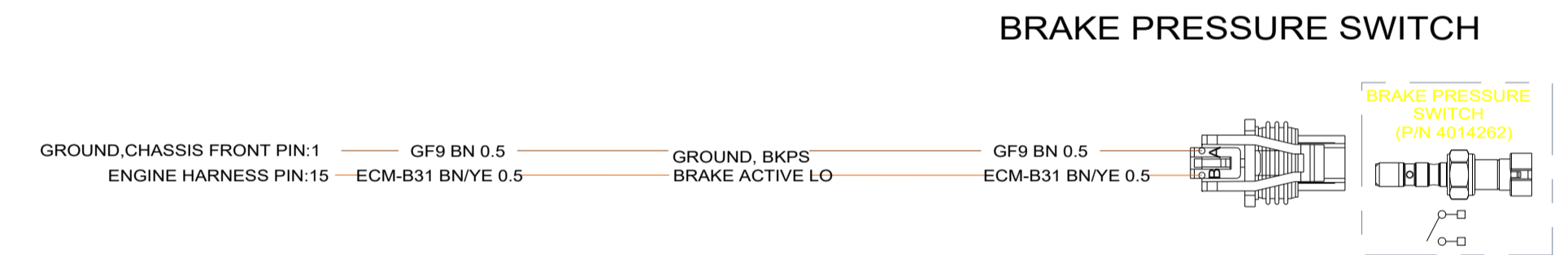
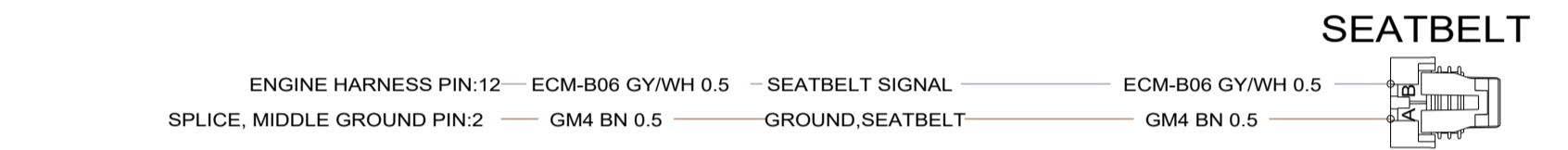
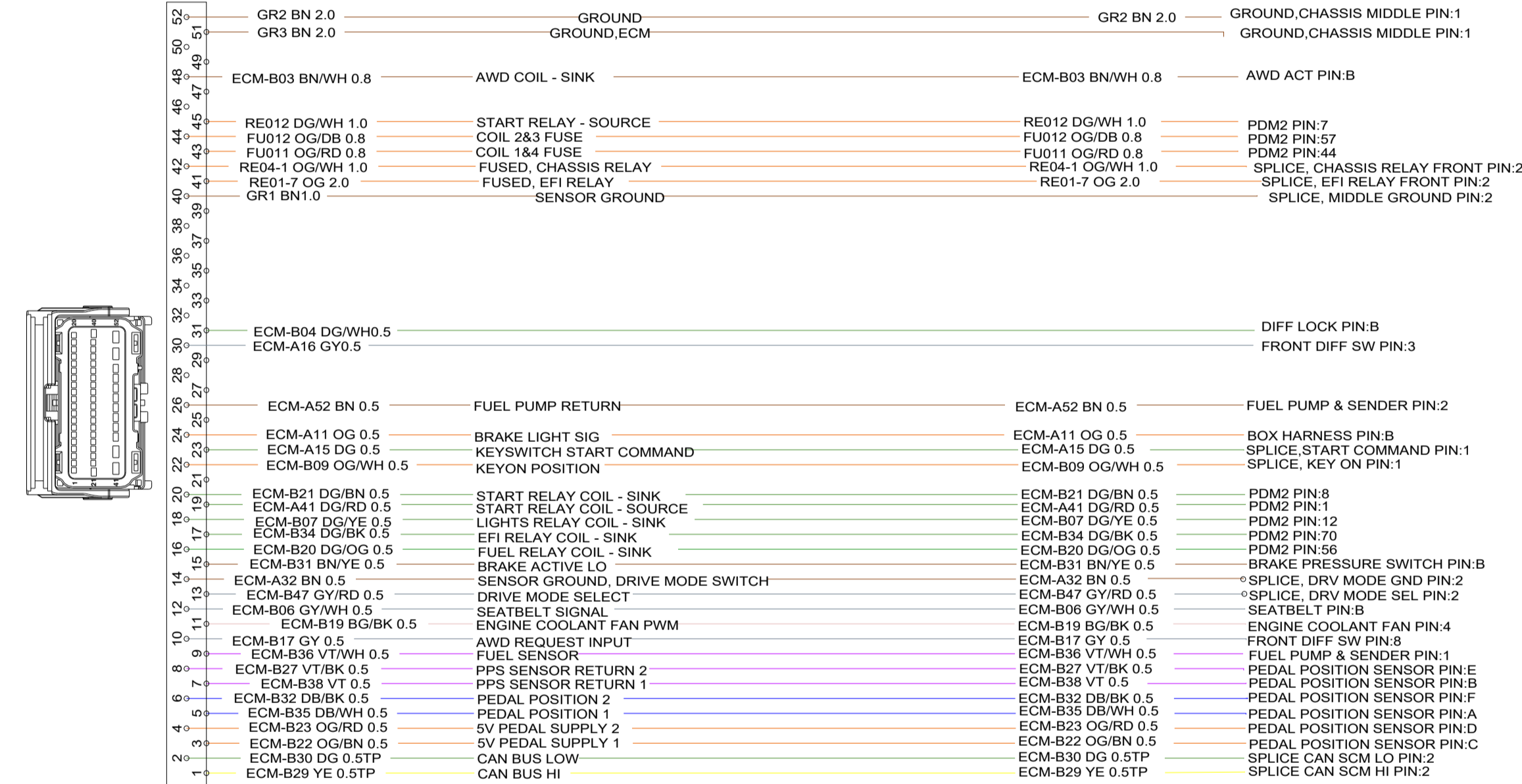

HARNESS-CHASSIS, RZR PRO R 4 (ULTIMATE)

WIRE COLOR LEGEND

BG	BEIGE (TAN)
BK	BLACK
BU	LIGHT BLUE
DB	DARK BLUE
BN	BROWN
GY	GRAY
GN	LIGHT GREEN
DK	DARK GREEN
OR	ORANGE
PK	PINK
RD	RED
VT	VIOLET (PURPLE)
WH	WHITE
YE	YELLOW
CL	CLEAR

TWO WIRE COLORS ARE SHOWN WITH MAINTRACE COLORS. EXAMPLE: RD/YE = RED WITH YELLOW TRACE

ENGINE GROUND
E

CHASSIS GROUND
C

NC = SWITCH NORMALLY CLOSED
NO = SWITCH NORMALLY OPEN

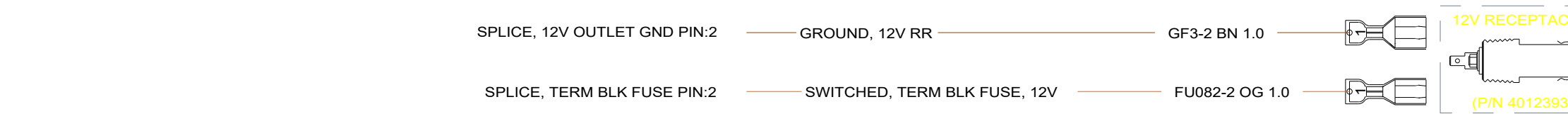
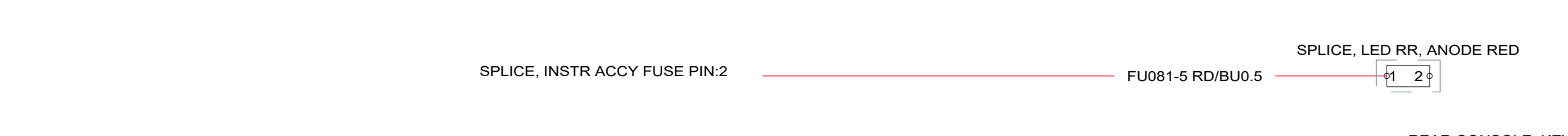
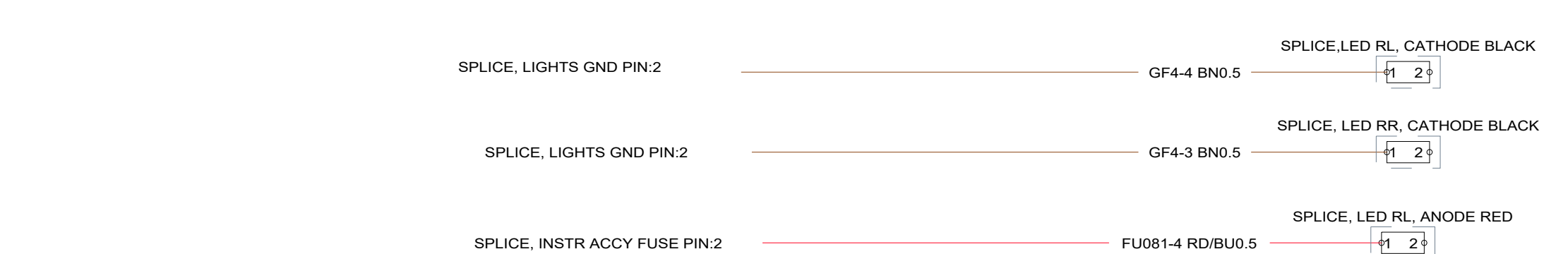
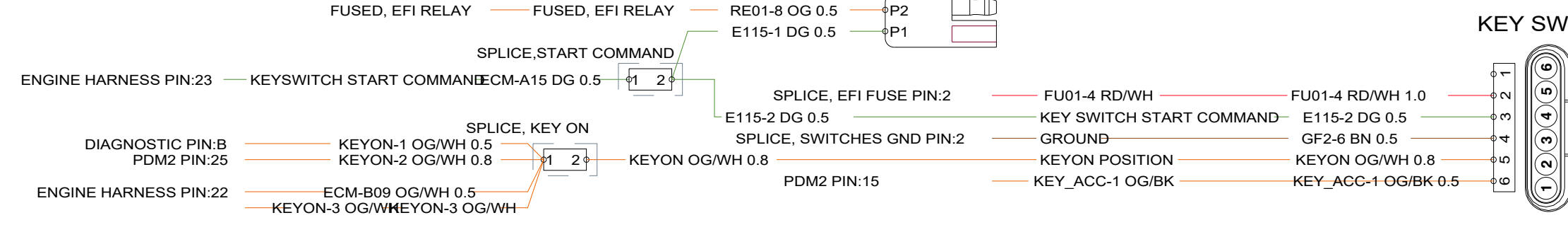
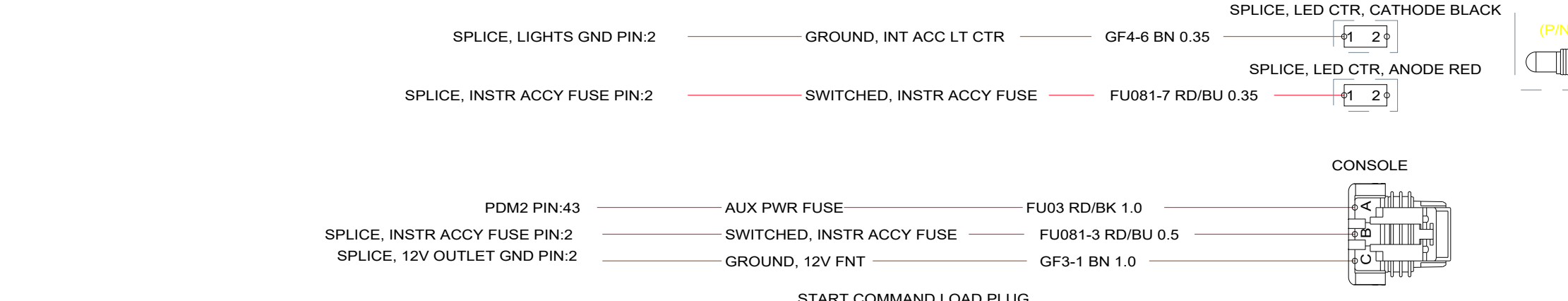
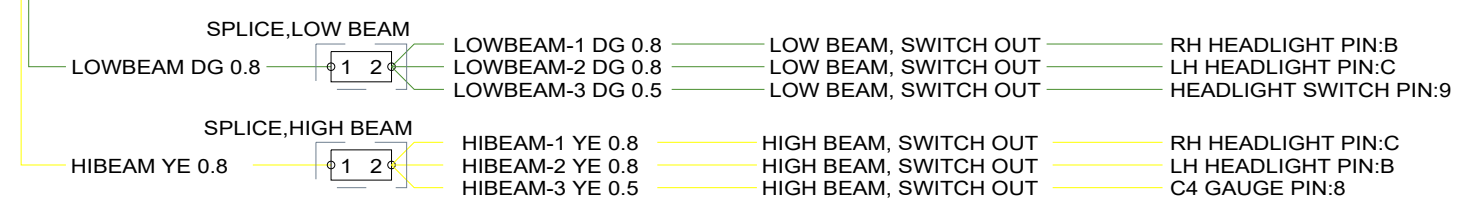
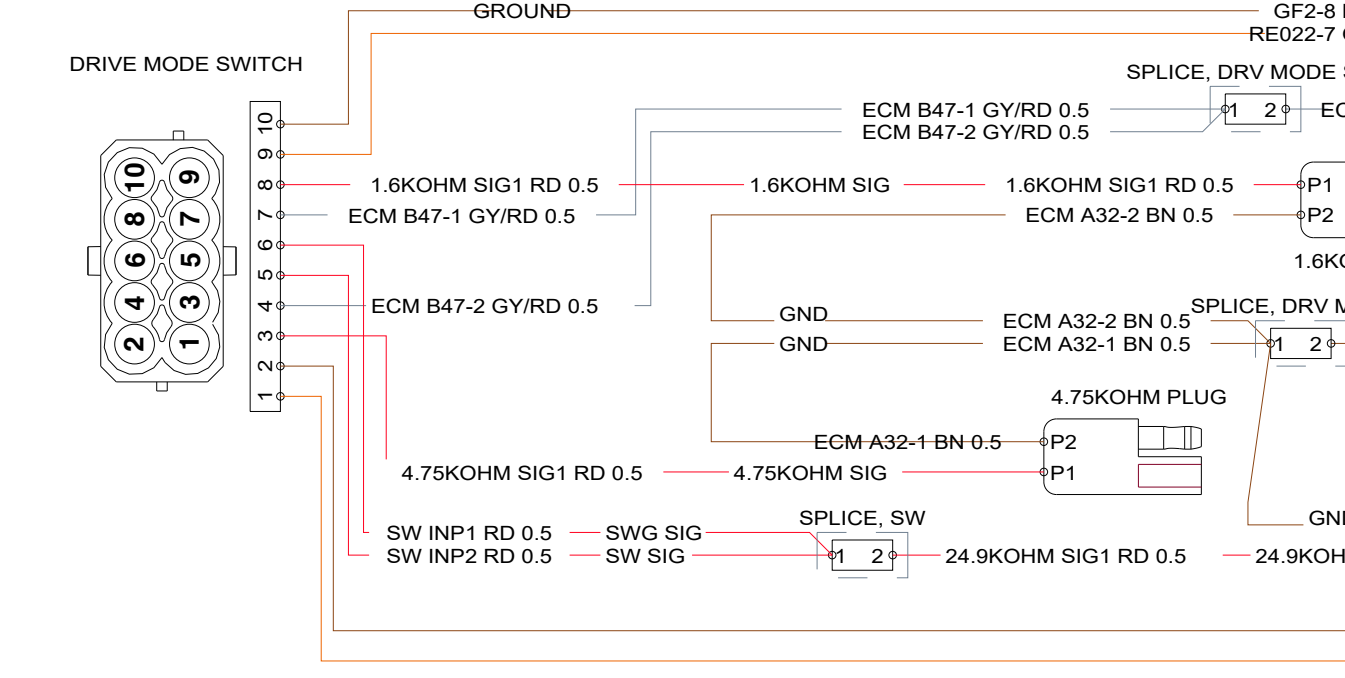
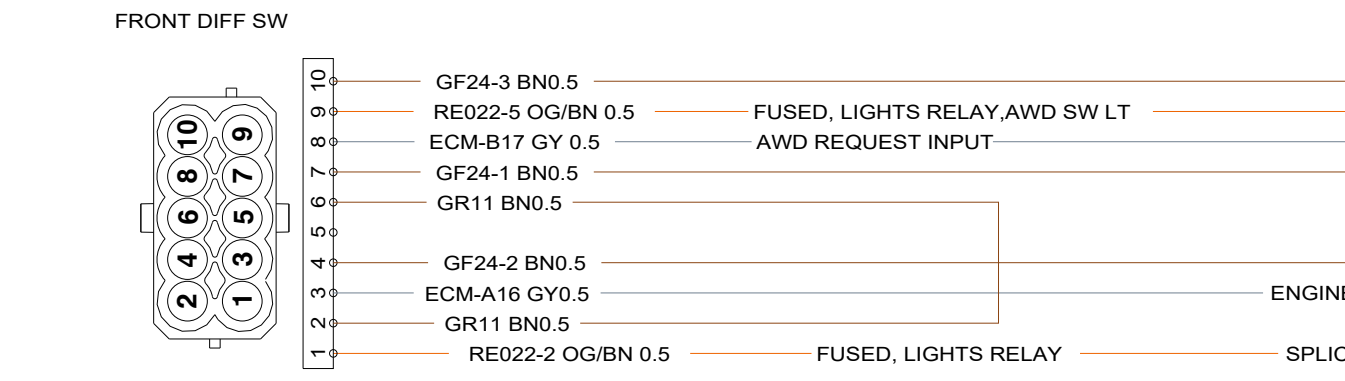
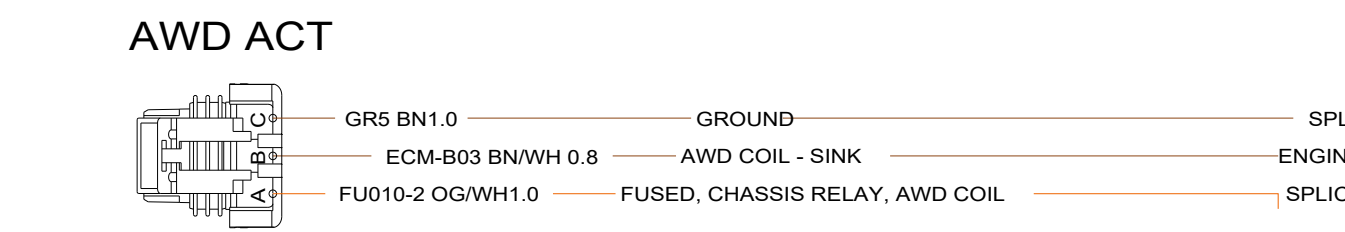
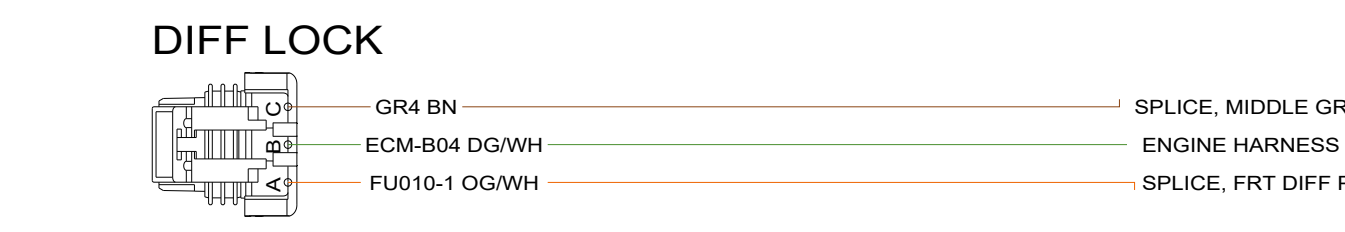
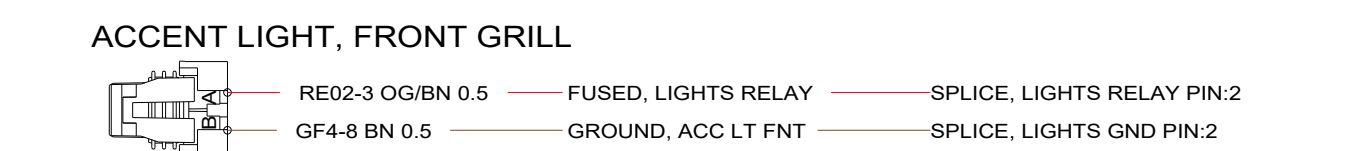
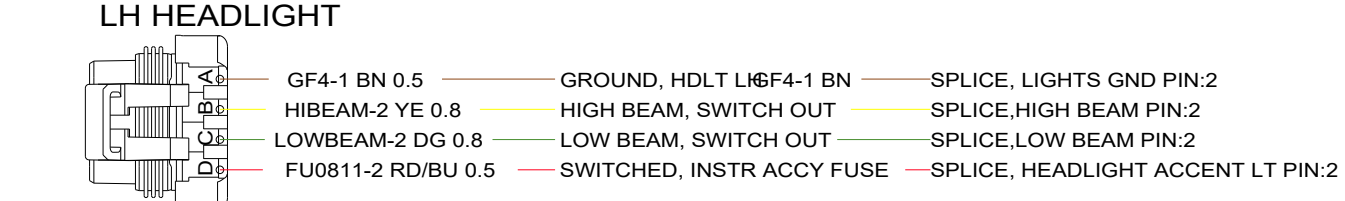
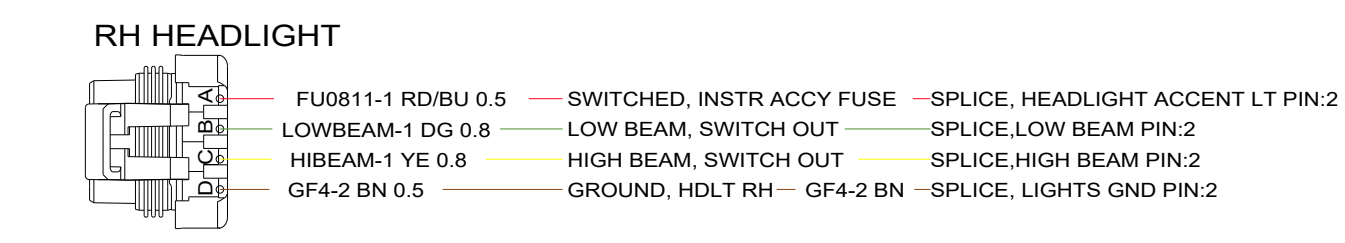
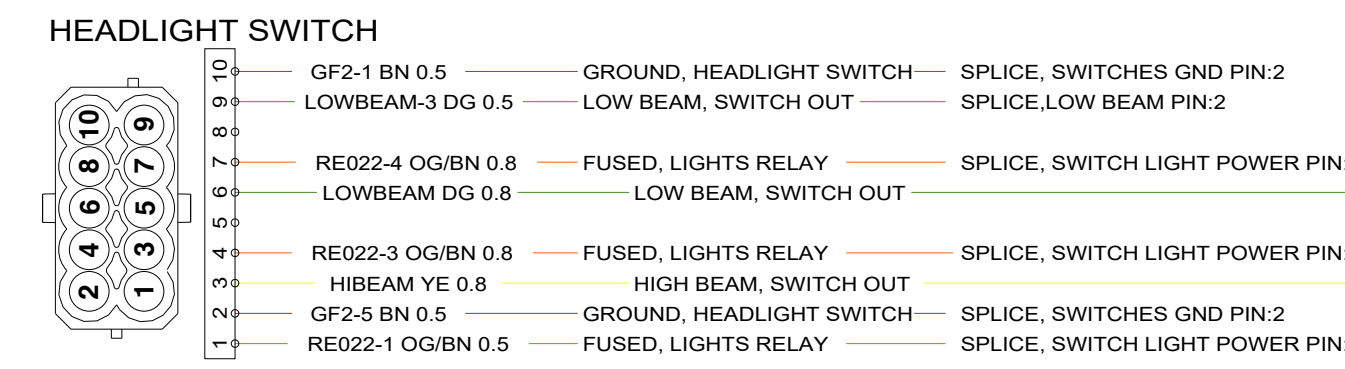
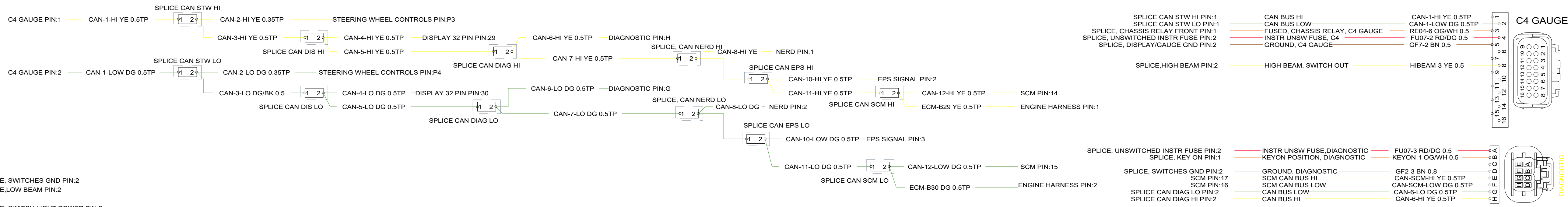

HARNESS: 2416573-01



HARNESS-CHASSIS, RZR PRO R 4 (ULTIMATE)

WIRE COLOR LEGEND	
BG	BEIGE (TAN)
BK	BLACK
BL	LIGHT BLUE
DB	DARK BLUE
BN	BROWN
GY	GRAY
GN	LIGHT GREEN
DG	DARK GREEN
OG	ORANGE
PK	PINK
RD	RED
VT	VIOLET (PURPLE)
WH	WHITE
YE	YELLOW
CL	CLEAR

TWO WIRE COLORS ARE SHOWN WITH MAIN/TRACE COLORS. EXAMPLE: RD/YE = RED WITH YELLOW TRACE.

 ENGINE GROUND
 CHASSIS GROUND
 NC = SWITCH NORMALLY CLOSED
 NO = SWITCH NORMALLY OPEN
 HARNESS: 2416573-01

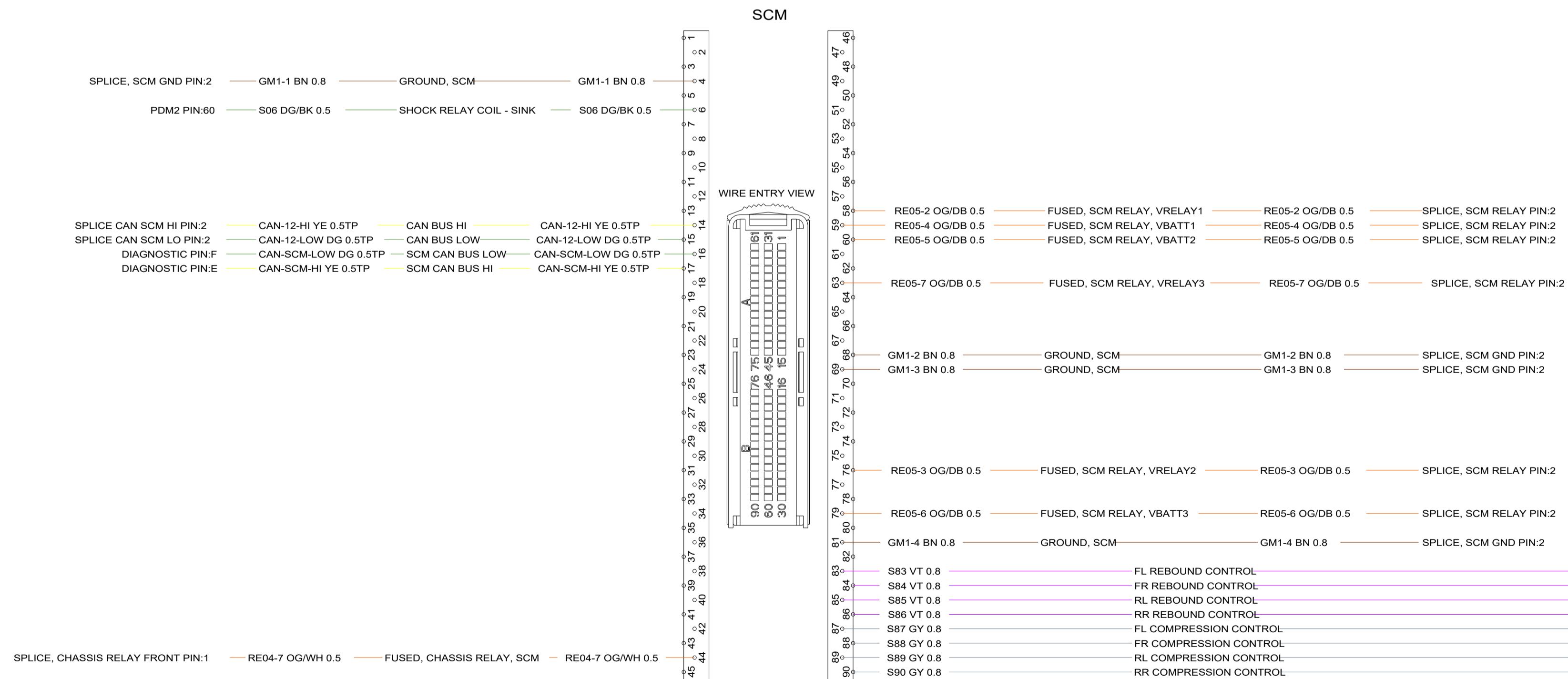

HARNESS-CHASSIS, RZR PRO R 4 (ULTIMATE)

WIRE COLOR LEGEND	
BG	BEIGE (TAN)
BK	BLACK
BL	LIGHT BLUE
DB	DARK BLUE
BN	BROWN
GY	GRAY
GN	LIGHT GREEN
DG	DARK GREEN
OR	ORANGE
PK	PINK
RD	RED
VT	VIOLET (PURPLE)
WH	WHITE
YE	YELLOW
CL	CLEAR

TWO WIRE COLORS ARE SHOWN WITH MAIN TRACE COLORS. EXAMPLE: RD/YE = RED WITH YELLOW TRACE.

ENGINE GROUND
CHASSIS GROUND
NC = SWITCH NORMALLY CLOSED
NO = SWITCH NORMALLY OPEN
HARNESS: 2416573-01

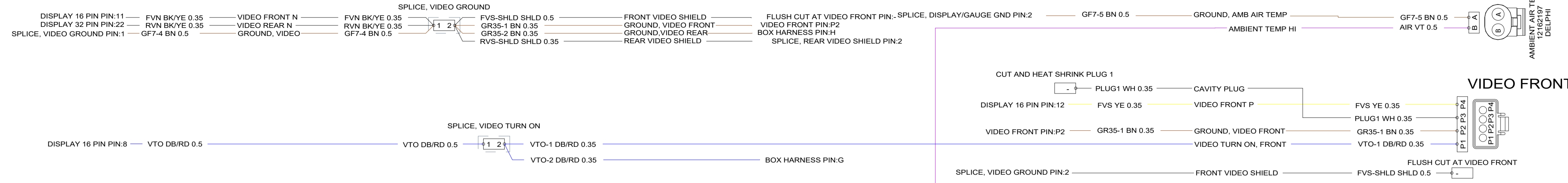

DISPLAY 32 PIN

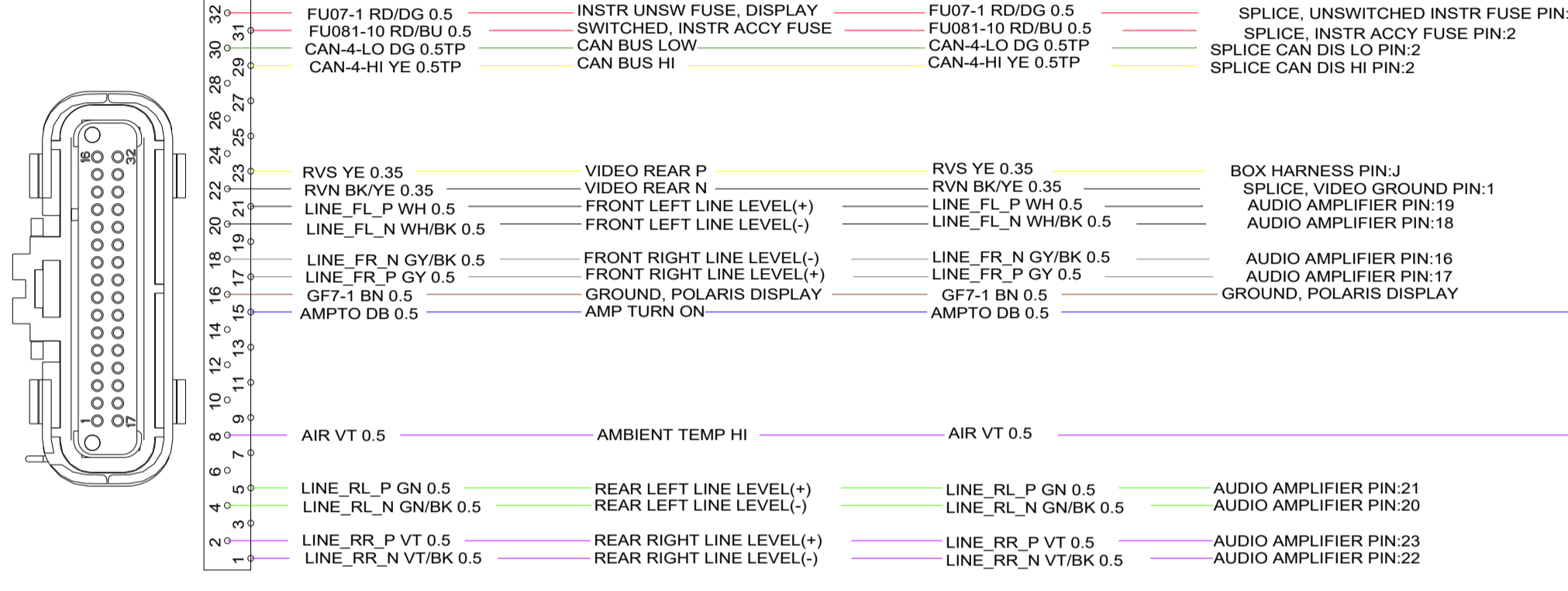

DISPLAY 16 PIN

