

PRODEMAND

YMMS: 2004 Honda Civic Si
Engine: 2.0L Eng
VIN:

Mar 4, 2023
License:
Odometer:

AIR CONDITIONING

Fig 1: Automatic A/C Circuit, Hybrid (1 of 2)

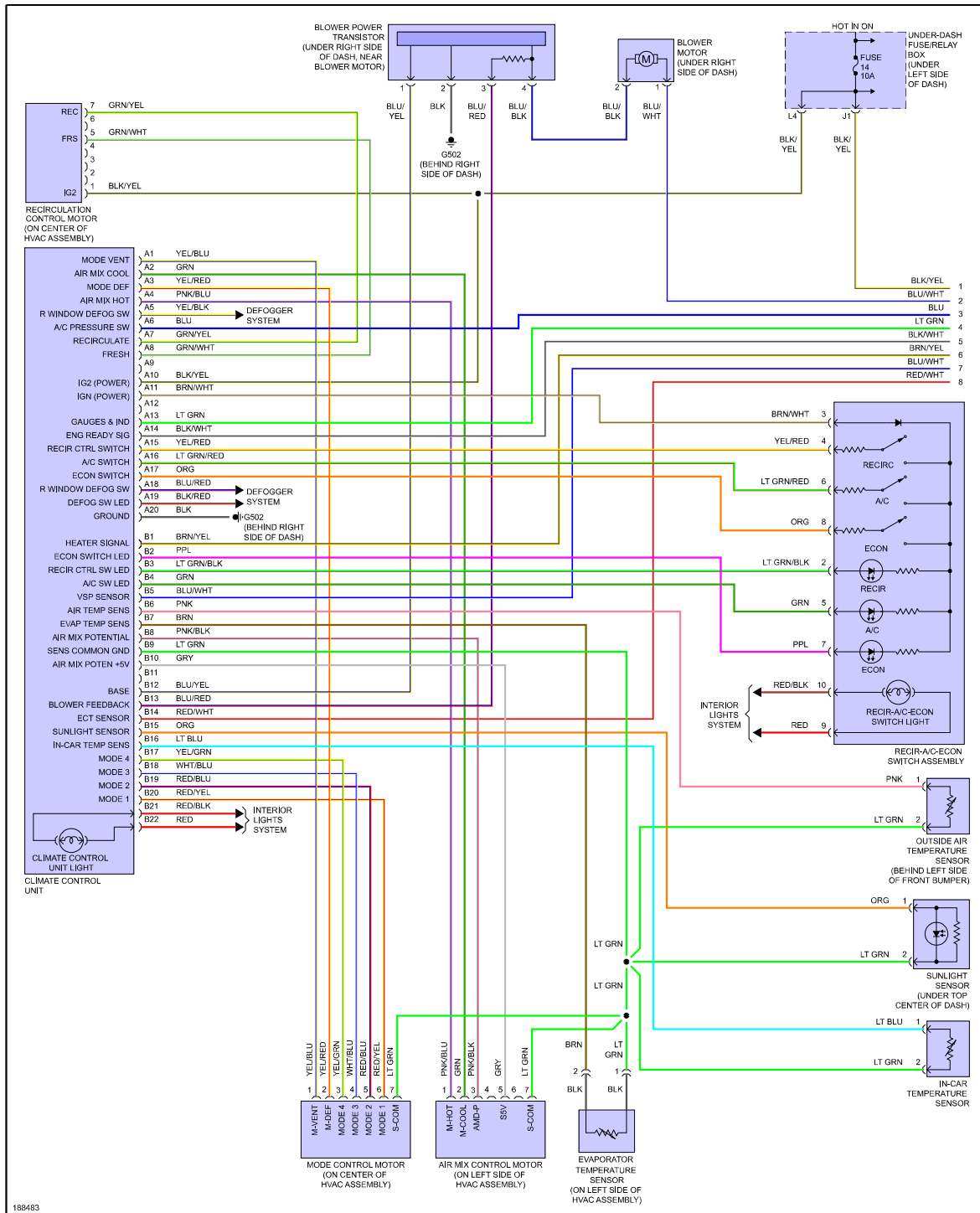

188483

Fig 2: Automatic A/C Circuit, Hybrid (2 of 2)

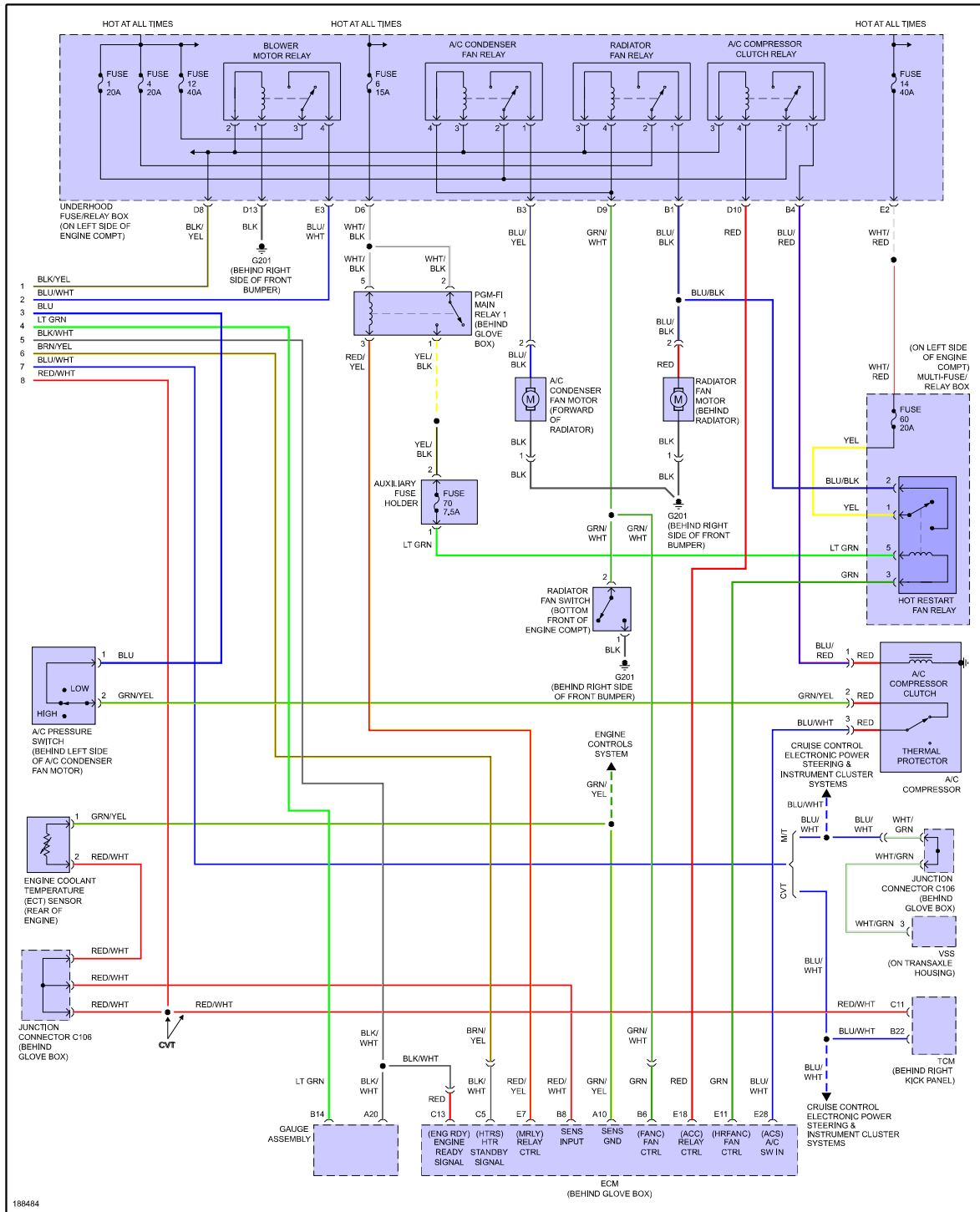

188484

Fig 3: Heater Circuit, Except Hatchback & Hybrid

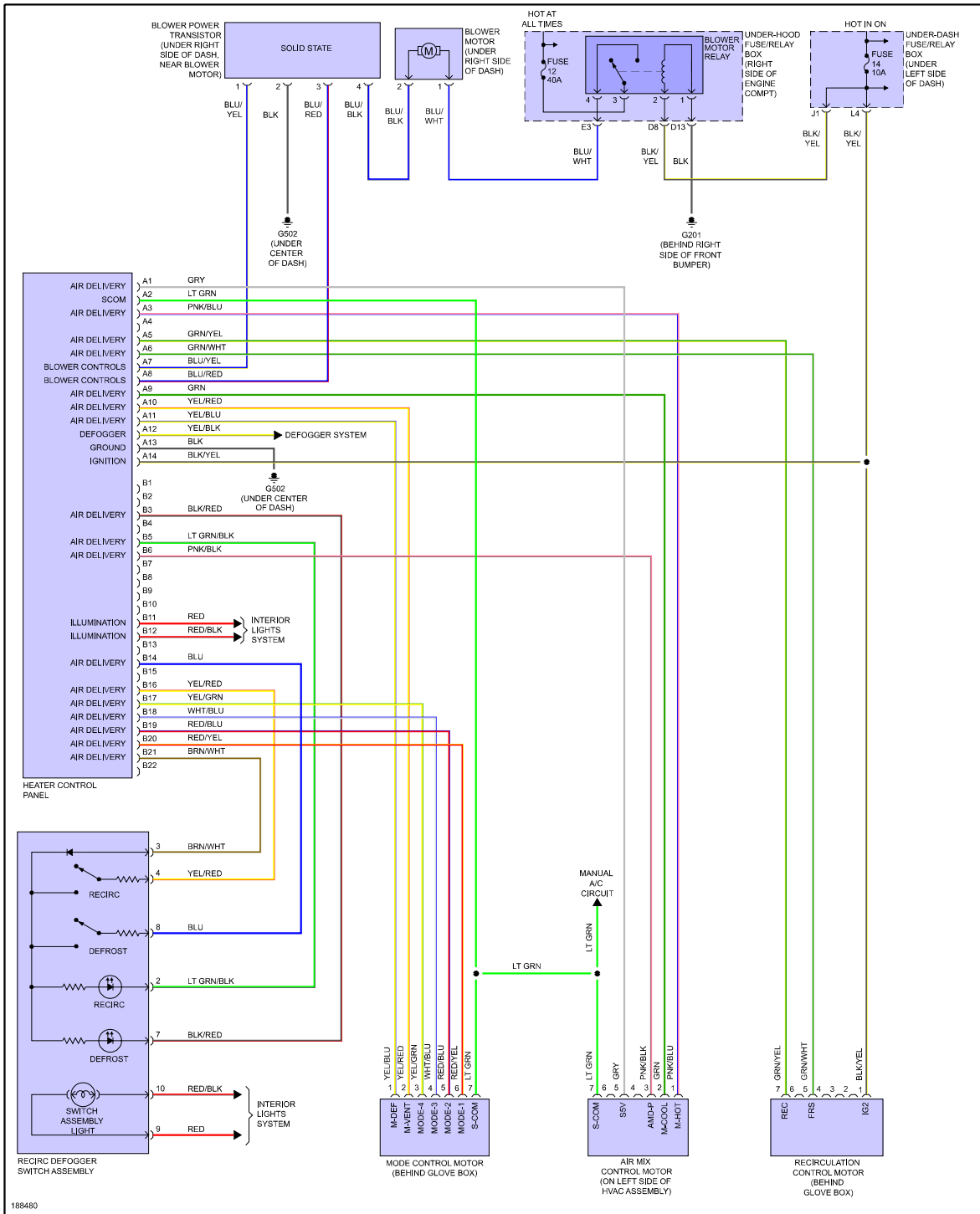

188480

Fig 4: Heater Circuit, Hatchback (1 of 2)

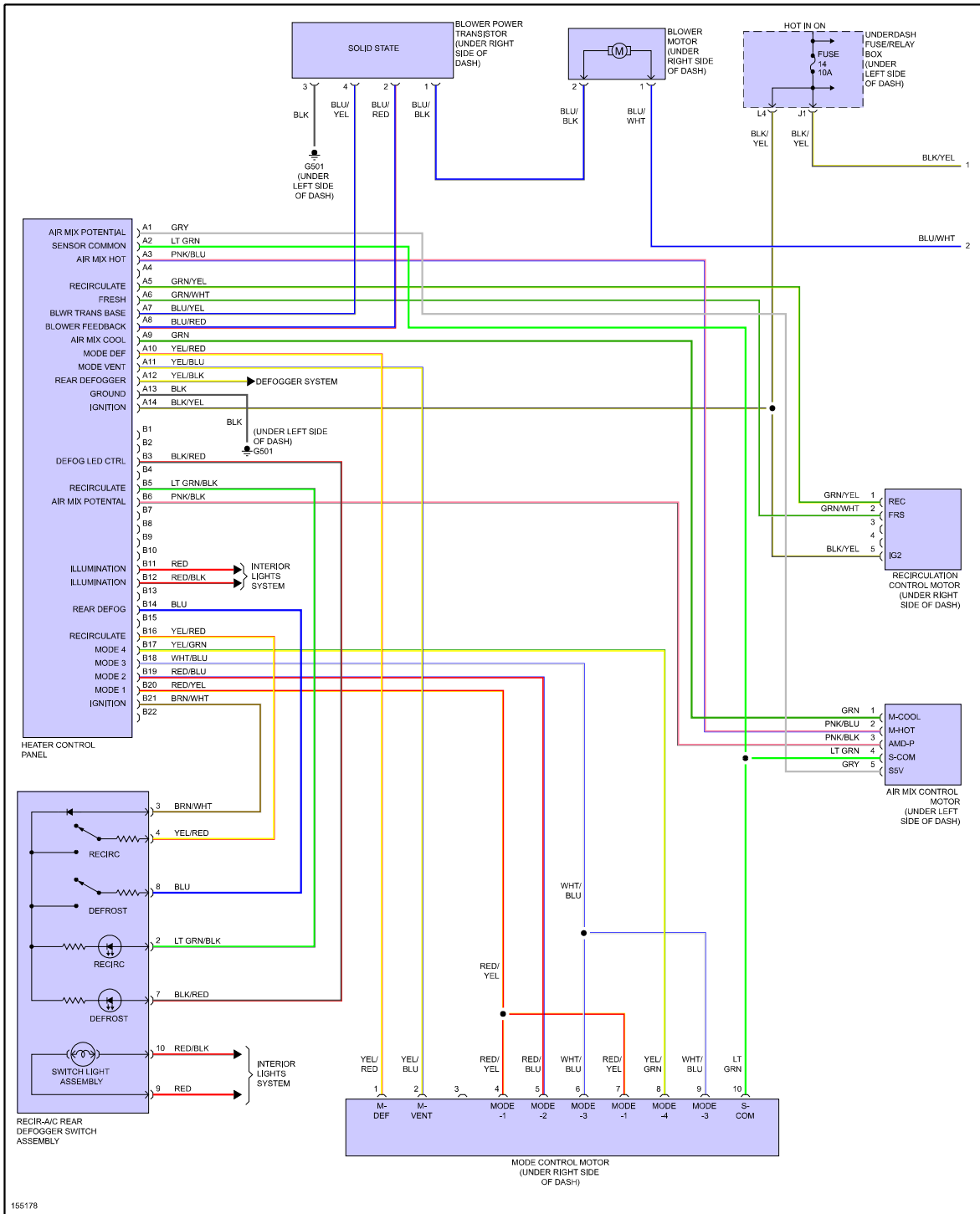

Fig 5: Heater Circuit, Hatchback (2 of 2)

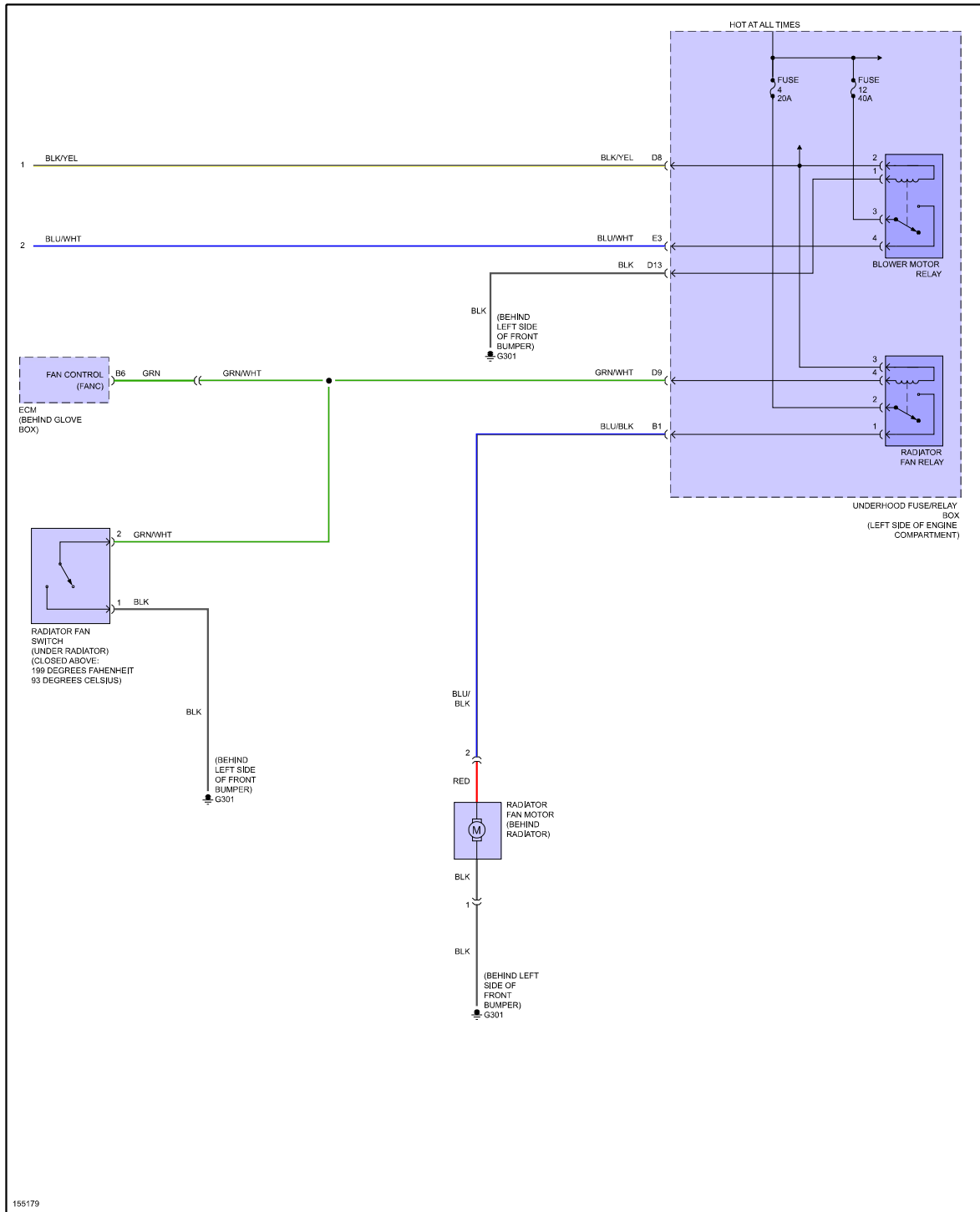
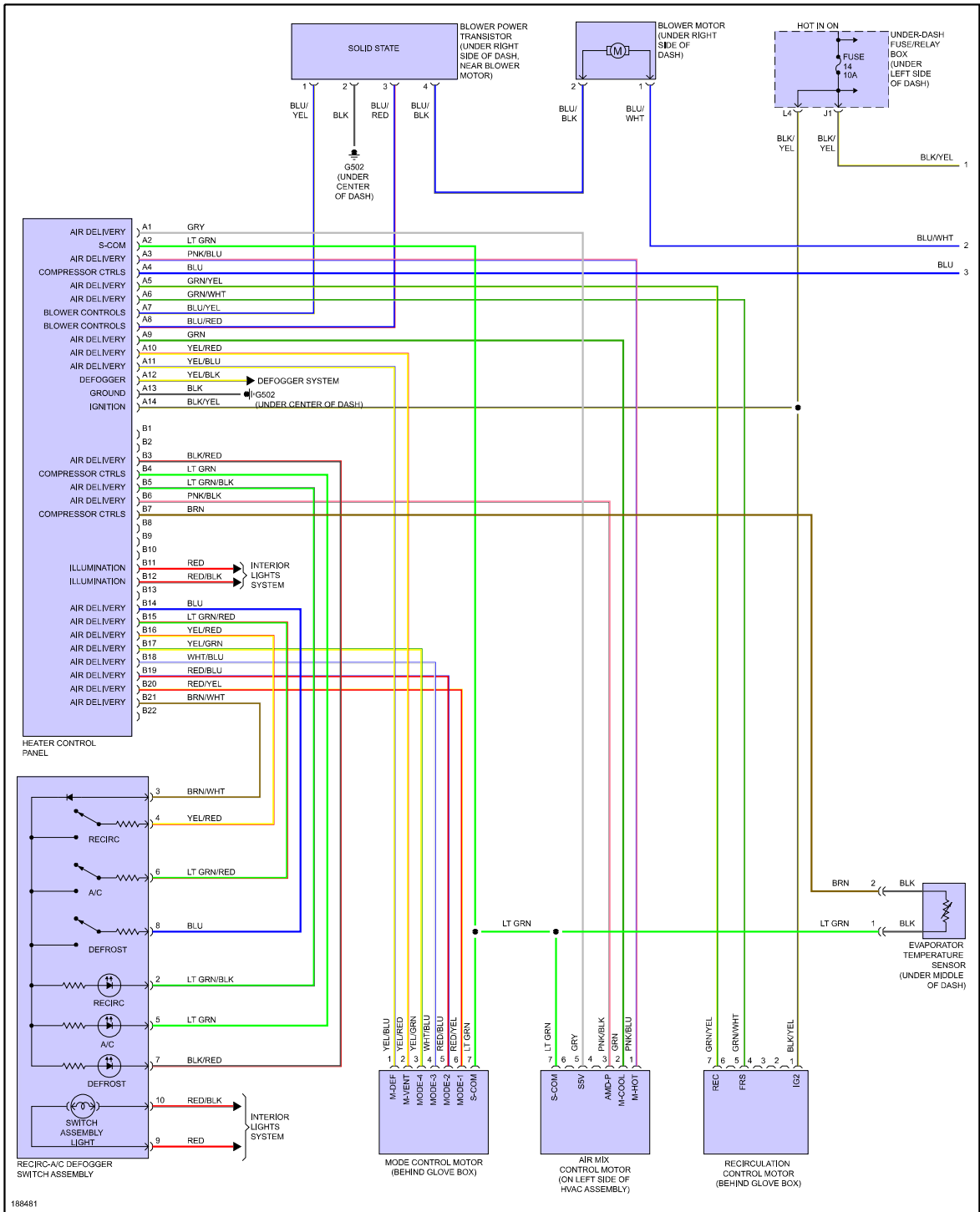

Fig 6: Manual A/C Circuit, Except Hatchback & Hybrid (1 of 2)



188481

Fig 7: Manual A/C Circuit, Except Hatchback & Hybrid (2 of 2)

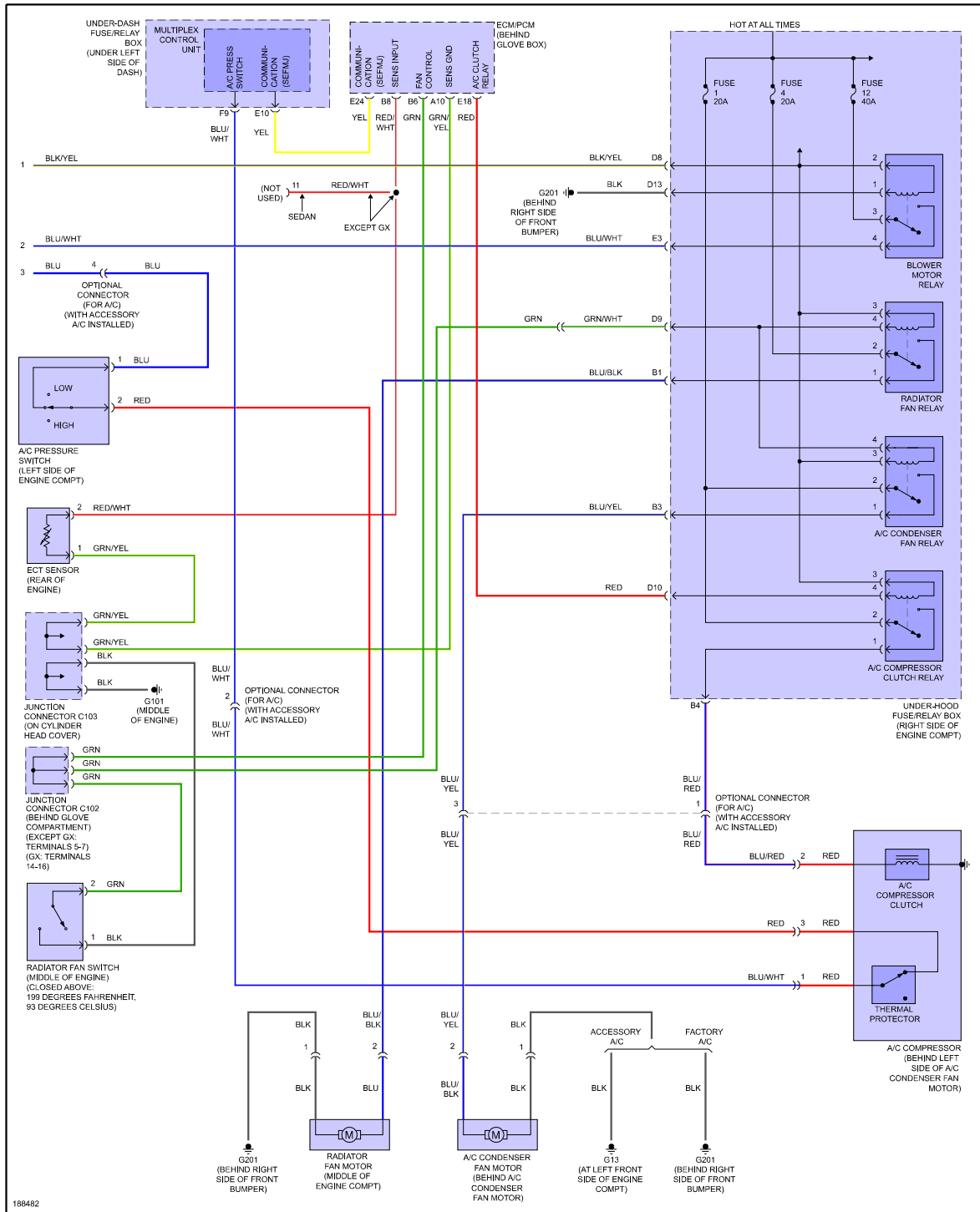

Fig 8: Manual A/C Circuit, Hatchback (1 of 2)

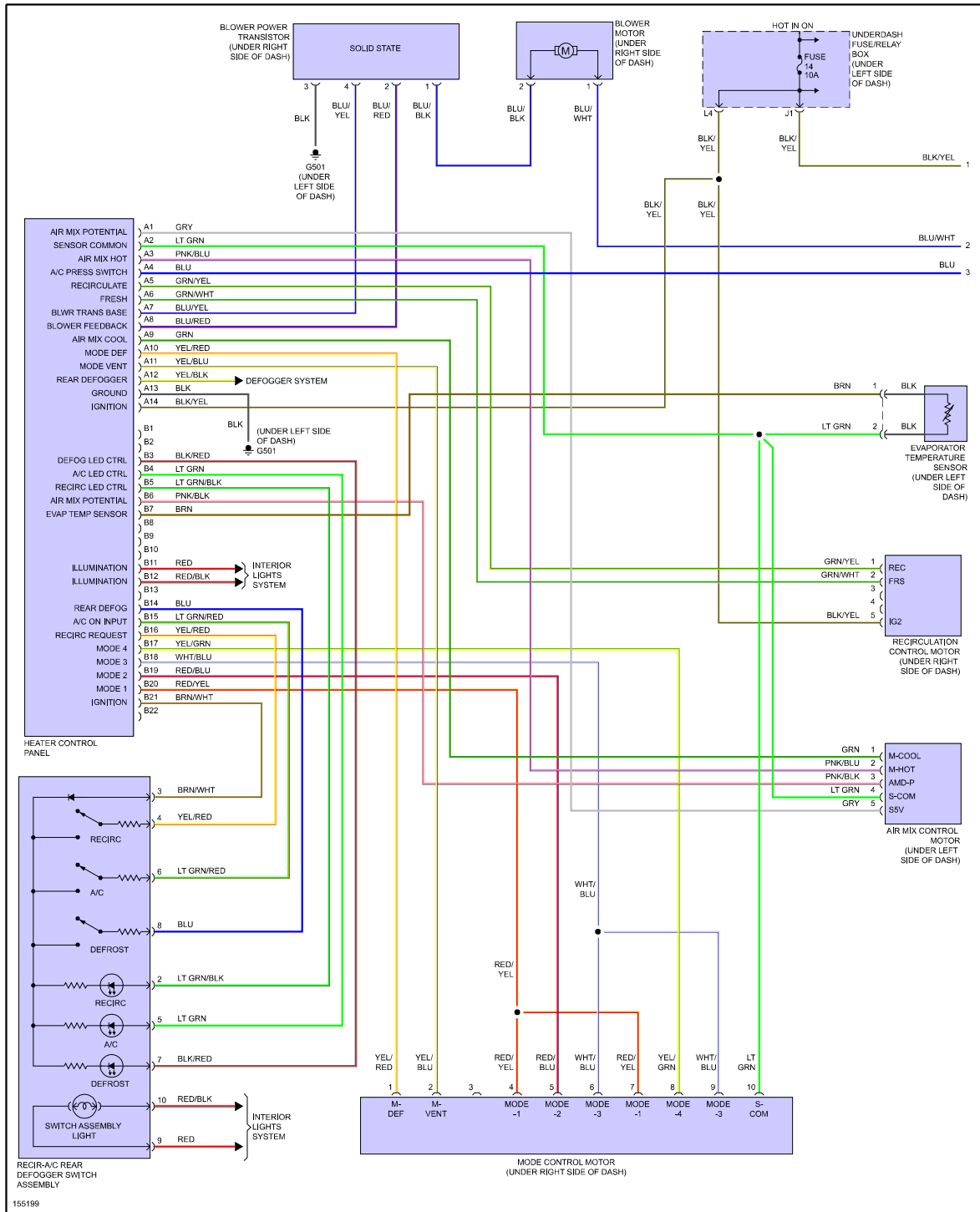

Fig 9: Manual A/C Circuit, Hatchback (2 of 2)

